

**Agilent U1241B and
U1242B
Handheld Digital
Multimeters**

User's and Service Guide



Agilent Technologies

Notices

© Agilent Technologies, Inc. 2009 – 2012

No part of this manual may be reproduced in any form or by any means (including electronic storage and retrieval or translation into a foreign language) without prior agreement and written consent from Agilent Technologies, Inc. as governed by United States and international copyright laws.

Manual Part Number

U1241-90063

Edition

Fourth Edition, June 22, 2012

Printed in Malaysia

Agilent Technologies, Inc.

5301 Stevens Creek Blvd.

Santa Clara, CA 95051 USA

Warranty

The material contained in this document is provided “as is,” and is subject to being changed, without notice, in future editions. Further, to the maximum extent permitted by applicable law, Agilent disclaims all warranties, either express or implied, with regard to this manual and any information contained herein, including but not limited to the implied warranties of merchantability and fitness for a particular purpose. Agilent shall not be liable for errors or for incidental or consequential damages in connection with the furnishing, use, or performance of this document or of any information contained herein. Should Agilent and the user have a separate written agreement with warranty terms covering the material in this document that conflict with these terms, the warranty terms in the separate agreement shall control.

Technology Licenses

The hardware and/or software described in this document are furnished under a license and may be used or copied only in accordance with the terms of such license.

Restricted Rights Legend

U.S. Government Restricted Rights. Software and technical data rights granted to the federal government include only those rights customarily provided to end user customers. Agilent provides this customary commercial license in Software and technical data pursuant to FAR 12.211 (Technical Data) and 12.212 (Computer Software) and, for the Department of Defense, DFARS 252.227-7015 (Technical Data - Commercial Items) and DFARS 227.7202-3 (Rights in Commercial Computer Software or Computer Software Documentation).

Safety Notices

CAUTION

















A **CAUTION** notice denotes a hazard. It calls attention to an operating procedure, practice, or the like that, if not correctly performed or adhered to, could result in damage to the product or loss of important data. Do not proceed beyond a **CAUTION** notice until the indicated conditions are fully understood and met.

WARNING





A **WARNING** notice denotes a hazard. It calls attention to an operating procedure, practice, or the like that, if not correctly performed or adhered to, could result in personal injury or death. Do not proceed beyond a **WARNING** notice until the indicated conditions are fully understood and met.

Safety Symbols

The following symbols on the instrument and in the documentation indicate precautions which must be taken to maintain safe operation of the instrument.

	Direct current (DC)		Off (supply)
	Alternating current (AC)		On (supply)
	Both direct and alternating current		Caution, risk of electric shock.
	Three-phase alternating current		Caution, risk of danger (refer to this manual for specific Warning or Caution information).
	Earth (ground) terminal		Caution, hot surface.
	Protective conductor terminal		Out position of a bi-stable push control.
	Frame or chassis terminal		In position of a bi-stable push control.
	Equipotentiality	CAT III 1000 V	Category III 1000 V Overvoltage Protection
	Equipment protected throughout by double insulation or reinforced insulation.	CAT IV 600 V	Category IV 600 V Overvoltage Protection

Regulatory Markings

	<p>The CE mark is a registered trademark of the European Community. This CE mark shows that the product complies with all the relevant European Legal Directives.</p>		<p>The C-tick mark is a registered trademark of the Spectrum Management Agency of Australia. This signifies compliance with the Australia EMC Framework regulations under the terms of the Radio Communication Act of 1992.</p>
<p>ICES/NMB-001</p>	<p>ICES/NMB-001 indicates that this ISM device complies with Canadian ICES-001.</p>		<p>This instrument complies with the WEEE Directive (2002/96/EC) marking requirement. This affixed product label indicates that you must not discard this electrical/electronic product in domestic household waste.</p>
	<p>The CSA mark is a registered trademark of the Canadian Standards Association.</p>		

Waste Electrical and Electronic Equipment (WEEE) Directive 2002/96/EC



This instrument complies with the WEEE Directive (2002/96/EC) marking requirement. This affixed product label indicates that you must not discard this electrical/electronic product in domestic household waste.

Product Category:

With reference to the equipment types in the WEEE directive Annex 1, this instrument is classified as a “Monitoring and Control Instrument” product. The affixed product label is shown as below:

Do not dispose in domestic household waste

To return this unwanted instrument, contact your nearest Agilent office, or visit:

www.agilent.com/environment/product

for more information.

General Safety Information

The following general safety precautions must be observed during all phases of operation, service and repair of this instrument. Failure to comply with these precautions or with specific warnings elsewhere in this manual violates safety standards of design, manufacture and intended use of the instrument. Agilent Technologies assumes no liability for the customer's failure to comply with these requirements.

WARNING

- **Observe all markings on the instrument before connecting any wiring to the instrument.**
- **When working above 60 VDC, 30 VAC RMS or 42 V peak, exercise caution – such range pose a shock hazard.**
- **Do not measure more than the rated voltage (as marked on the multimeter) between terminals, or between terminal and earth ground.**
- **Double-check the multimeter's operation by measuring a known voltage.**
- **For current measurement, turn off circuit power before connecting the multimeter to the circuit. Always place the multimeter in series with the circuit.**
- **When connecting probes, always connect the common test probe first. When disconnecting probes, always disconnect the live test probe first.**
- **Detach test probes from the multimeter before you open the battery cover.**
- **Do not use the multimeter with the battery cover or part of the cover removed or loose.**
- **Replace the battery as soon as the low battery indicator  flashes on screen. This is to avoid false readings, which may lead to possible electric shock or personal injury.**
- **Do not operate the product in an explosive atmosphere or in the presence of flammable gases or fumes.**
- **Inspect the case for cracks or missing plastic. Pay extra attention to the insulation surrounding the connectors. Do not use the multimeter if it is damaged.**
- **Inspect the test probes for damaged insulation or exposed metal, and check for continuity. Do not use the test probe if it is damaged.**

WARNING

- **Do not use repaired fuses or short-circuited fuse-holders. For continued protection against fire, replace the line fuses only with fuses of the same voltage and current rating and recommended type.**
 - **Do not service or perform adjustments alone. Under certain condition, hazardous voltages may exist, even with the equipment switched off. To avoid dangerous electric shock, service personnel must not attempt internal service or adjustment unless another person, capable of rendering resuscitation or first aid, is present.**
 - **Do not substitute parts or modify equipment to avoid the danger of introducing additional hazards. Return the product to Agilent Technologies Sales and Service Office for service and repair to ensure the safety features are maintained**
 - **Do not operate damaged equipment as the safety protection features built into this product may have been impaired, either through physical damage, excessive moisture, or any other reason. Remove power and do not use the product until safe operation can be verified by service-trained personnel. If necessary, return the product to Agilent Technologies Sales and Service Office for service and repair to ensure the safety features are maintained.**
-

CAUTION

- Turn off circuit power and discharge all high-voltage capacitors in the circuit before you perform resistance, continuity, diodes, or capacitance tests.
 - Use the correct terminals, function, and range for your measurements.
 - Never measure voltage when current measurement is selected.
 - Ensure proper insertion of battery in the multimeter, and follow the correct polarity.
-

Environment Conditions

This instrument is designed for indoor use, in areas with low condensation and to be used with standard or compatible test probes.

Environment Conditions	Requirements
Operating environment	Full accuracy at $-10\text{ }^{\circ}\text{C}$ to $55\text{ }^{\circ}\text{C}$
Operating relative humidity	Full accuracy up to 80% RH for temperature up to $30\text{ }^{\circ}\text{C}$, decreasing linearly to 50% RH at $55\text{ }^{\circ}\text{C}$
Storage environment	$-20\text{ }^{\circ}\text{C}$ to $70\text{ }^{\circ}\text{C}$
Altitude	0 – 2000 meters per IEC 61010-1 2 nd Edition CAT III, 1000 V/ CAT IV, 600 V
Pollution Degree	Pollution Degree II

CAUTION

The Agilent U1241B and U1242B are safety-certified in compliance with the following safety and EMC requirements:

- IEC 61010-1:2001 / EN61010-1:2001
- USA: UL 61010-1:2004
- Canada: CSA C22.2 No. 61010-1:2004
- IEC 61326-1:2005/ EN 61326-1:2006
- Canada: ICES/NMB-001:2004
- Australia/New Zealand: AS/NZS CISPR11:2004

Declaration of Conformity (DoC)

The Declaration of Conformity (DoC) for this instrument is available on the Web site. You can search the DoC by its product model or description.

<http://regulations.corporate.agilent.com/DoC/search.htm>

NOTE

If you are unable to search for the respective DoC, please contact your local Agilent representative.

In This Guide...

- 1 Getting Started** Chapter 1 introduces key features and steps to get started with a U1241B or U1242B handheld digital multimeter. This chapter also guides you through the basics of the front panel operations.
- 2 Features and Functions** Chapter 2 contains the information on how to set up connections to perform multimeter measurements. It also describes the features and functions that are available in the U1241B and U1242B handheld digital multimeters in step-by-step instructions.
- 3 Default Setting Configurations** Chapter 3 describes on how to change and configure the default setting of the U1241B and U1242B handheld digital multimeters including data logging and other setting features
- 4 Service and Maintenance** Chapter 4 provides the information on the warranty, services, maintenance procedures and troubleshooting hints to solve general problems that you may encounter with the multimeter.
- 5 Performance Tests and Calibration** Chapter 5 contains the procedures of the performance verification tests and calibration adjustments.
- 6 Specifications and Characteristics** Chapter 6 lists the specifications and characteristics of the U1241B and U1242B handheld digital multimeters.

Contents

1	Getting Started	1
	Introduction	2
	Checking the Shipping Contents	3
	The Front Panel at a Glance	4
	Adjusting Tilt Stand	4
	The Annunciator at a Glance	5
	Analog Bar Graph	6
	The Keypad and Rotary Switch at a Glance	6
	The Input Terminal at a Glance	9
2	Features and Functions	9
	Measuring Voltage	10
	Measuring Current (> 440 mA)	10
	Measuring Current (< 440 mA)	11
	Measuring % Scale of 4 – 20 mA	11
	Measuring Frequency	12
	Measuring Resistance and Testing Continuity	12
	Testing Diodes	13
	Measuring Capacitance	14
	Measuring Temperature	14
	Measuring Harmonic Ratio (U1242B)	16
	Using Switch Counter	16
	MinMax Recording	18
	Data Hold (Trigger Hold)	19
	Refresh Hold	19
	Null (Relative)	20
	Data Logging (U1242B)	20
	Scanning Temperature Measurement (U1242B)	23
	Checking Battery Capacity	24
	Alerts and Warning During Measurement	25

3	Default Setting Configurations	25
	Setting Configurations	26
4	Service and Maintenance	29
	General Maintenance	30
	Battery Replacement	30
	Fuse Replacement	31
	Troubleshooting	33
	Returning Instrument for Service	35
6	Performance Tests and Calibration	35
	Calibration Overview	36
	Closed-case Electronic Calibration	36
	Calibration Interval	36
	Adjustment is Recommended	37
	Recommended Test Equipment	38
	Basic Operating Test	39
	Backlight Test	39
	Testing the Display	39
	Input-A Terminal Test	40
	Input-mA Terminal Alert Test	40
	Calibration Process	40
	Test Considerations	41
	Input Connections	42
	Performance Verification Tests	42
	Calibration Security	46
	Using the Front Panel for Adjustments	48
	Adjustment Considerations	49
	Valid Adjustment Input Values	50
	Calibration Adjustments	51
	Exiting Adjustment Mode	55
	Calibration Count	56
	Calibration Errors	56

6	Specifications and Characteristics	57
	DC Specifications	58
	AC Specifications	59
	Resistance Specifications	60
	Diode Check/Audible Continuity Test Specifications	60
	Temperature Specifications	61
	Capacitance Specifications	62
	Harmonic Ratio Specifications	62
	Frequency Specifications	63
	Operating Specifications	64
	General Characteristics	65

Contents



1 Getting Started

Introduction	2
Checking the Shipping Contents	3
The Front Panel at a Glance	4
Adjusting Tilt Stand	4
The Annunciator at a Glance	5
The Keypad and Rotary Switch at a Glance	6
The Input Terminal at a Glance	9

This chapter introduces key features and steps to get started with a U1241B or U1242B handheld digital multimeter. This chapter also guides you through the basics of the front panel operations.



Introduction

The handheld digital multimeters' key features are:

- DC, AC voltage and current measurements.
- True-RMS measurement for both AC voltage and current
- Harmonic ratio for power quality of sine wave (for U1242B)
- Switch counter for detecting the bounce of switch
- Ambient temperature display with each measurement
- Scan temperature measurement for T1, T2 and T1-T2 (for U1242B)
- Resistance measurement up to 100 M Ω
- Diode and audible continuity tests
- Capacitance measurement up to 10mF
- The % scale readout for 4–20 mA or 0–20 mA measurement
- Temperature test with selectable 0 °C compensation (without ambient temperature compensation).
- K-type (for U1241B) and J/K-types temperature measurement (for U1242B)
- MinMax Recording for minimum, maximum and average readings
- Data Hold with manual or auto trigger
- Null/Relative function
- Auto or manual data logging memories (for U1242B)
- Battery capacity indicator
- Adjustable brightness level of orange LED backlight display
- Closed case calibration
- 10,000 count precision true RMS digital multimeter, designed to meet EN/IEC 61010-1:2001 Category III 1000 V/ Category IV 600 V Overvoltage Protection, Pollution Degree II standards

Checking the Shipping Contents

Verify that you have received the following items for the standard shipped items or optional accessories that you may have ordered. If any of the above item missing, or any mechanical damage and defect on the multimeter, notify your nearest Agilent Technologies Sales Office.

Table 1-1 List of standard items and optional accessories

Type	Model ID	Items
Standard		U1241B or U1242B handheld digital multimeter
		Four 1.5 V AAA alkaline batteries
		Silicone test leads
		4 mm probes
		Quick Start Guide
		Certificate of Calibration
Optional	U1162A	Alligator clips
	U1163A	SMT Grabbers
	U1164A	Fine tip test probe
	U1181A	Immersion probe type-K
	U1182A	Industrial surface probe
	U1183A	Air probe
	U1184A	Temperature probe adapter
	U1185A	Thermocouple (J-type) probe and adapter
	U1186A	Thermocouple (K-type) probe and adapter
	U1583B	AC current clamp
	U1165A	Test probe leads
	U1168A	Standard test lead set with 4 mm test probes
	U1169A	Standard test leads with 4 mm probe tip
	U1171A	Magnetic hanging kit
	U1172A	Transit case for handheld DMM, aluminium-clad
U1174A	Soft carrying case	

The Front Panel at a Glance

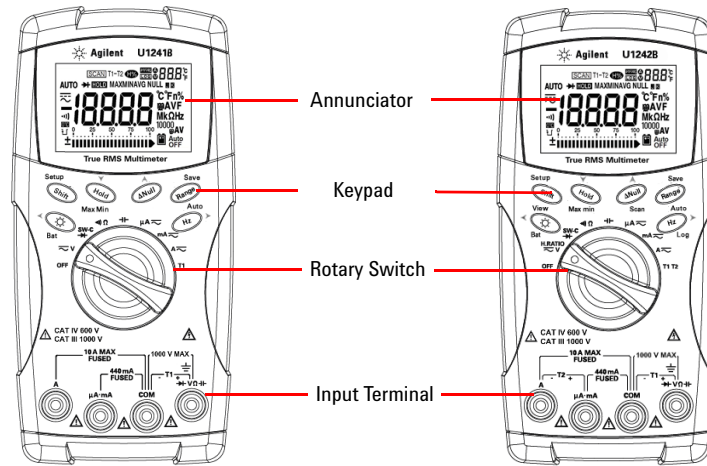
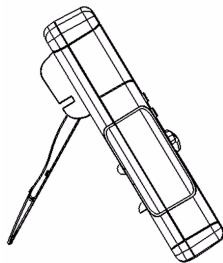

Figure 1-1 Front panel of a U1241B and U1242B handheld digital multimeters

Adjusting Tilt Stand

Tilt stand at 60°



Pull the tilt stand outwards to its maximum reach (approximately 60°)

Tilt stand at 30°

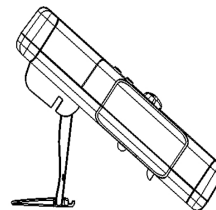

Bend the tip of the stand

Figure 1-2 Tilt stand positions

The Annunciator at a Glance

To view the full display, press and hold **Hold** while turning the rotary switch from OFF to any non-OFF position. Press any key to resume normal functionality mode.

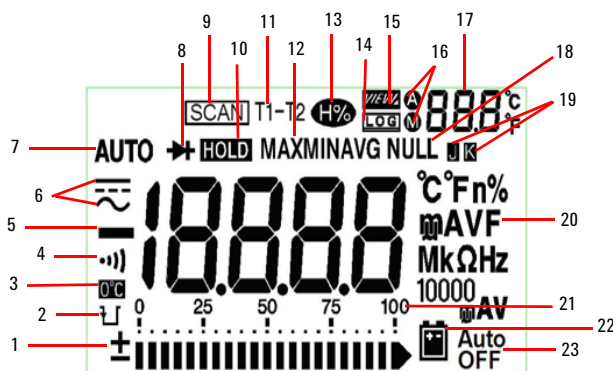

Figure 1-3 Annunciator display of a U1242B handheld digital multimeter

Table 1-2 Descriptions of each annunciator



No.	Descriptions	No.	Descriptions
1	21-segment analog bar graph display	12	MinMax Recording mode
2	Capacitor discharge indicator	13	Harmonic Ratio mode (for U1242B)
3	Cold junction of ambient temperature disabled	14	Data logging mode (for U1242B)
4	Audible continuity for resistance and diode function	15	Data logging View mode (for U1242B)
5	Primary display -18.888	16	Auto or manual for data logging mode and datalog viewing mode
6	AC or DC measurement mode	17	Secondary display (temperature display)
7	Auto range	18	Null math function
8	Diode / Audible continuity	19	Thermocouple type for temperature measurement
9	T1, T2 and T1 – T2 temperature measurements scan (for U1242B)	20	Primary measurement units
10	Data hold	21	Measurement range
11	T1, T2* or T1 – T2* temperature measurements	22	Low battery indicator
		23	Auto power off indicator

*T2 temperature measurement and delta (T1 – T2) are only available for U1242B.

Analog Bar Graph

When frequency is indicated on the primary display during voltage or current measurement, the bar graph represents the voltage or current value. When 4–20 mA% scale or 0–20 mA% scale is indicated on the primary display, the bar graph represents the current value. Each segment represents 500 or 50 counts depending on the range indicated on the peak bar graph.

Table 1-3 Bar graph counts

Range	Counts / Segment	Function
	50	Diode
	500	V, A, Ω , 

The Keypad and Rotary Switch at a Glance

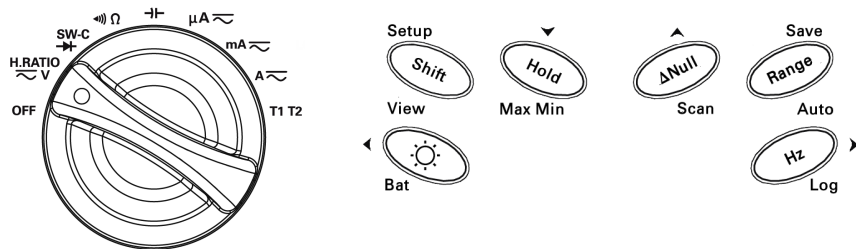

Figure 1-4 Keypad and rotary switch of a U1242B handheld digital multimeter

Table 1-4 Keypad descriptions and functions



















Function	First level functions	Range	Second level functions (press )	Range
OFF	Turn off the multimeter			
	DCV measurement	0.1 mV to 1000 V	ACV measurement	0.1 mV to 1000 V
			Harmonic ratio (for U1242B only)	0.0% to 99.9%
	Diode measurement		Switch counter measurement	
	Resistance measurement	0.1 Ω to 100 M Ω	Audible continuity measurement	
	Capacitance measurement	0.1 nF to 10 mF		
μA 	DC μA	0.1 μA to 10 mA	AC μA measurement	0.1 μA to 10 mA
mA 	DCmA	0.01 mA to 440 mA	ACmA measurement	0.01 mA to 440 mA
			mA% scale	
A 	DCA	0.001 A to 10 A	ACA measurement	0.001 A to 10 A
T1	T1 temperature	-40 $^{\circ}\text{C}$ to 1000 $^{\circ}\text{C}$	T2 and T1–T2 temperature measurements (for U1242B)	-40 $^{\circ}\text{C}$ to 1000 $^{\circ}\text{C}$

Table 1-5 Features that can be accessed through front panel keypad

Actions	Steps
Turns ON backlight	Press 
Checks battery capacity	Press and hold  for > 1 second
Freezes the measured value	Press 
Starts MIN/MAX/AVG recording	Press and hold  for > 1 second
Offsets the measured value	Press 
Scans the measured temperature (for U1242B only)	Press and hold  for > 1 second
Changes the measuring range	Press 
Turns on auto range	Press and hold  for > 1 second
Measures frequency for AC signal	Press 
Starts manual data logging	Press and hold  for > 1 second

1 Getting Started

NOTE

Please use manual ranging to measure AC signal with a DC offset.

The Input Terminal at a Glance

WARNING

To avoid damaging this device, do not exceed the input limit.

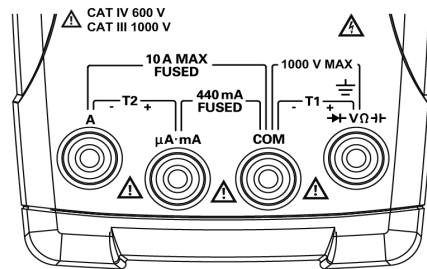
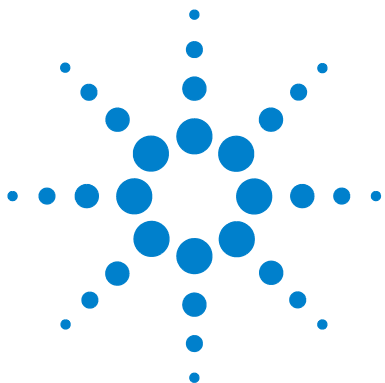

Figure 1-5 Input terminal of a U1242B handheld digital multimeter

Table 1-6 Terminal connections for different measuring functions

Measurement Functions	Input terminal		Overload Protection
Voltage	→VΩ←	COM	1000 V R.M.S.
Diode			1000 V R.M.S.
Resistance			< 0.3 A short circuit current
Capacitance			
μA & mA	μA mA	COM	440 mA/1000 V 30 kA/fast-acting fuse
A	A	COM	11 A/1000 V 30 kA/fast-acting fuse
Temperature	+T1	-T1	1000 V R.M.S.
Temperature (for U1242B only)	+T2	-T2	440 mA/1000 V 30 kA/fast-acting fuse

1 Getting Started



2 Features and Functions

Measuring Voltage	10
Measuring Current (> 440 mA)	10
Measuring Current (< 440 mA)	11
Measuring % Scale of 4 – 20 mA	11
Measuring Frequency	12
Measuring Resistance and Testing Continuity	12
Testing Diodes	13
Measuring Capacitance	14
Measuring Temperature	14
Measuring Harmonic Ratio (U1242B)	16
Using Switch Counter	16
MinMax Recording	18
Data Hold (Trigger Hold)	19
Refresh Hold	19
Null (Relative)	20
Data Logging (U1242B)	20
Scanning Temperature Measurement (U1242B)	23
Checking Battery Capacity	24
Alerts and Warning During Measurement	25

This chapter contains the detailed information on how to configure connections to perform the multimeter measurements using the U1241B and U1242B handheld digital multimeters. It builds on information already provided in the Quick Start Guide.



Measuring Voltage

WARNING

Ensure that terminal connections are correct for that particular measurement before any measurement. To avoid damaging the device, do not exceed the input limit.

Measuring DC Voltage

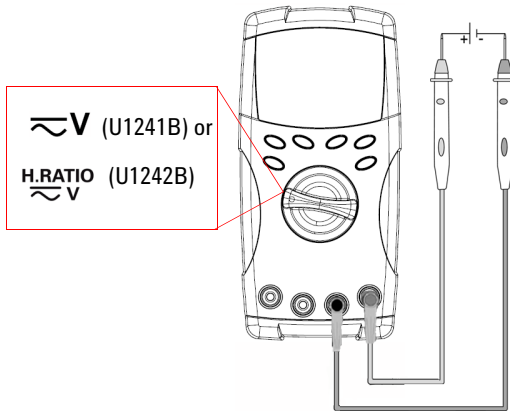

Measuring AC Voltage

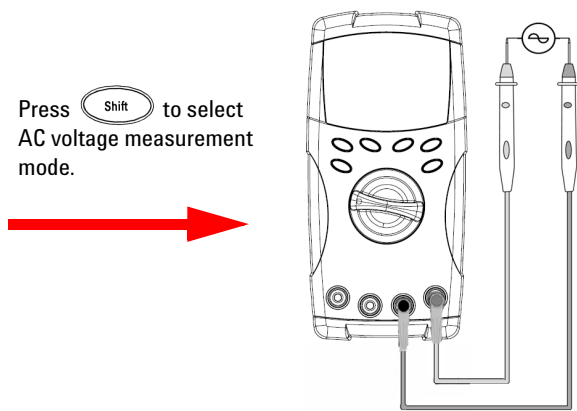

Measuring Current (> 440 mA)

Measuring DC current

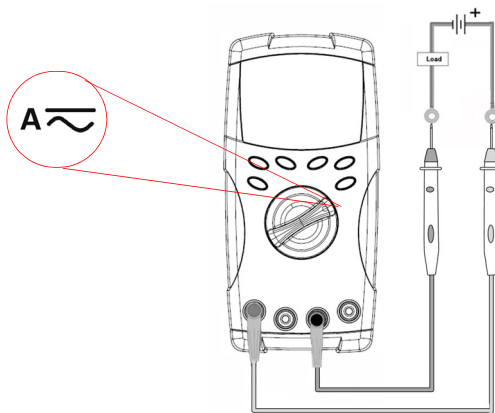

Measuring AC current

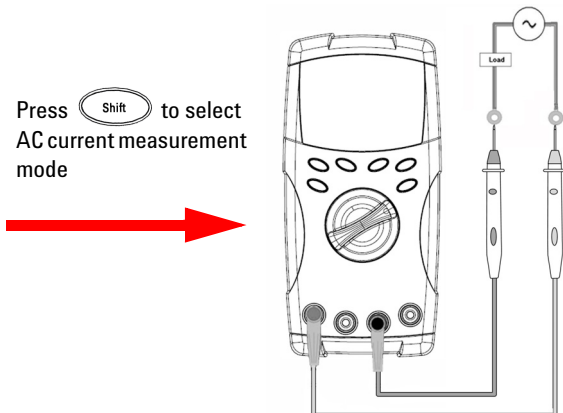

Measuring Current (< 440 mA)

NOTE

If the measured value is lower than 440 mA, use the mA or μ A current measurement mode.

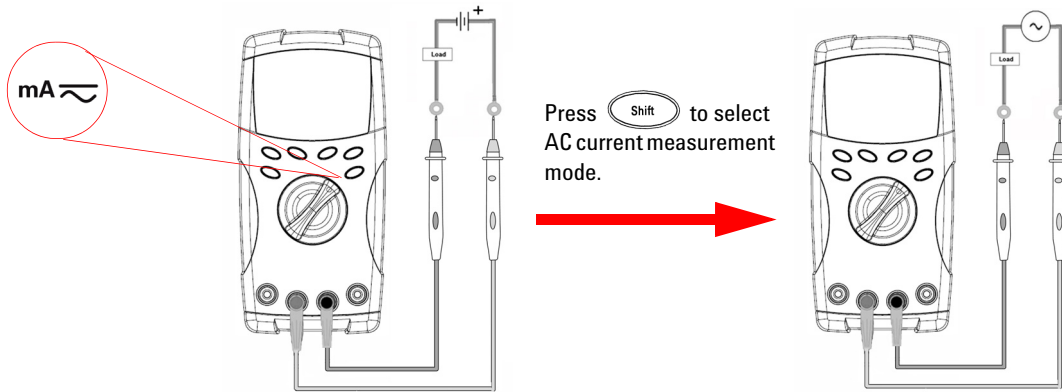

Measuring % Scale of 4 – 20 mA

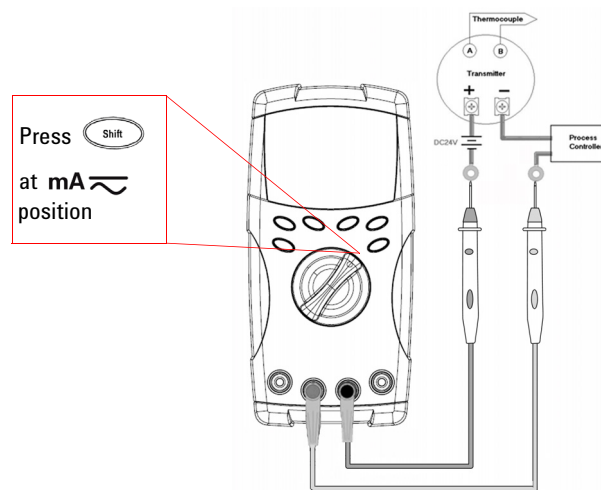

The % scale of 0 – 20 mA or 4 – 20 mA is selectable in setup mode. The mA% scale for 4-20 or 0-20 is indicated on primary display and the bar graph indicates the current value. The 25% scale readout represents DC 8 mA at 4 – 20mA, and DC 5 mA at 0 – 20mA.

Measuring Frequency

Press **Hz** at $\sim V$ (U1241B) or **H.RATIO** $\sim V$ (U1242B) position

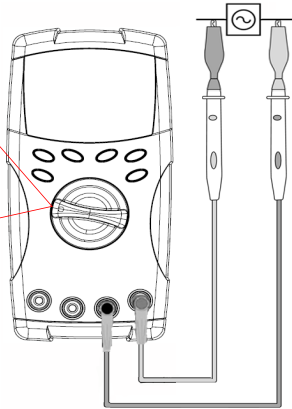

The frequency measurement is applicable for DC and AC current measurements.

The bar graph is used to indicate the value of AC voltage. Alternatively, press **Range** button to display the value of AC voltage. The multimeter will return to frequency value display automatically after three seconds.

Measuring Resistance and Testing Continuity

CAUTION

Disconnect circuit power and discharge all high-voltage capacitors before measuring resistance to prevent possible damage to the multimeter or the device under test.

Press **Shift** at Ω position to enable the continuity test function

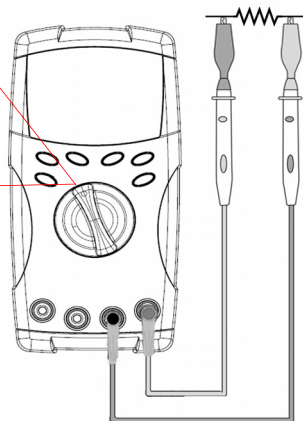

Measurement range	Beeper sounds when
1000.0 Ω	< 10 Ω
10.000 k Ω	< 100 Ω
100.00 k Ω	< 1 k Ω
1.0000 M Ω	< 10 k Ω
10.000 M Ω	< 100 k Ω
100.00 M Ω	< 1 M Ω

NOTE

Press  button to select measurement range from 1 k Ω to 100 M Ω .

Testing Diodes

CAUTION

Disconnect circuit power and discharge all high-voltage capacitors before testing diodes to prevent possible damage to the multimeter.

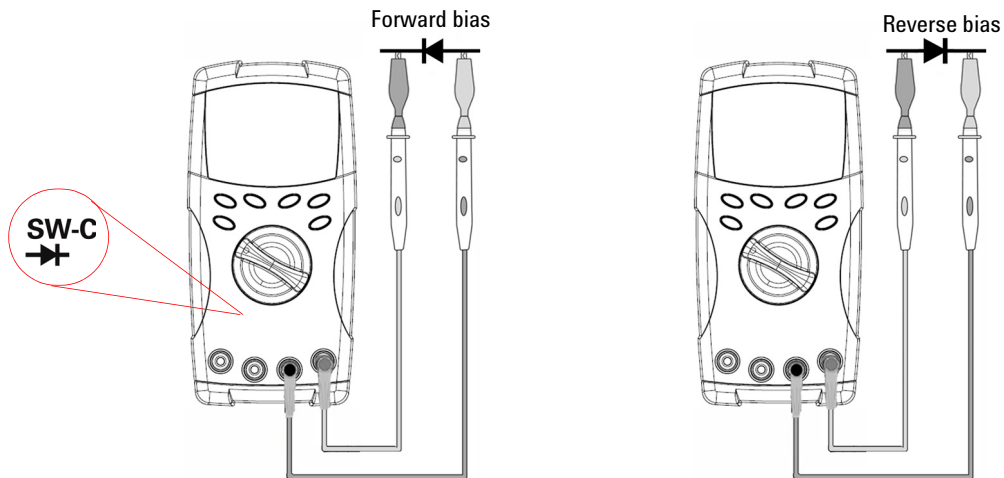
**NOTE**

The multimeter can display diode forward bias of up to approximately 1.1 V. Typical diode forward bias is between the range of 0.3 to 0.8 V range with audible beeper sound.

Measuring Capacitance

CAUTION

Disconnect circuit power and discharge all high-voltage capacitors before measuring capacitance to prevent possible damage to the multimeter or the device under test. To confirm that capacitors have discharged, use the DC voltage function.

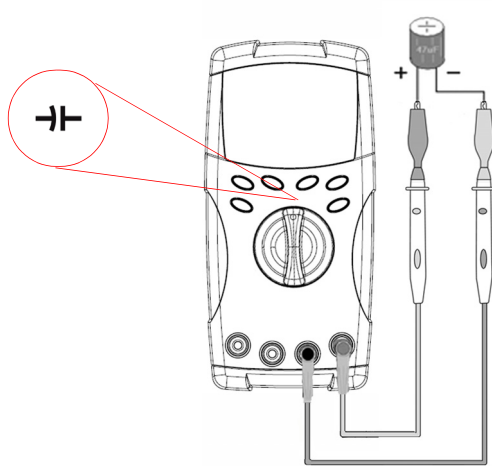

Measuring tips:

- For measuring capacitances greater than 10,000 μF , discharge the capacitor and manually select a suitable measurement range. This will speed up measuring time in order to obtain the correct capacitance value.
- Ensure the correct polarity when measuring polarized capacitors.
- For measuring small capacitances, press  with the test leads open to subtract the residual capacitance of the multimeter and leads.

Measuring Temperature

CAUTION

- Do not bend the thermocouple leads at sharp angles. Repeated bending over a period of time can break leads.
- Do not contact the temperature sensor to any surface that is energized voltage or current sources, such the voltage source will pose a shock hazard.

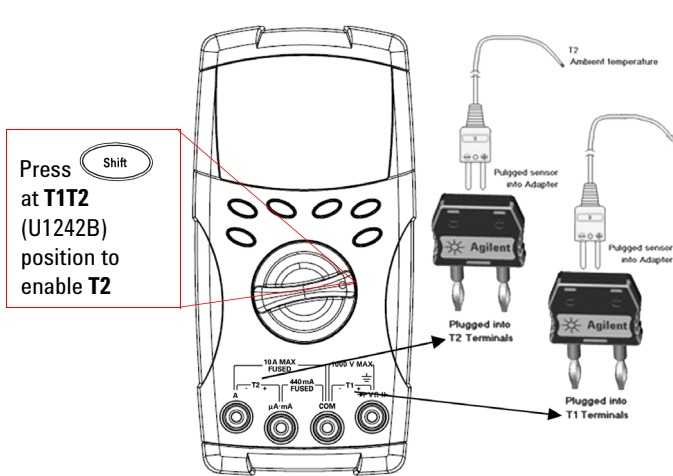
**Measuring tips:**

- Clean the measurement surface and remember to disable the applied power.
- When measuring temperature, move the thermocouple along the surface until you get the highest/lowest temperature reading.
- For quick measurement, use the 0 °C compensation to see the temperature variation of the thermocouple sensor. The 0 °C compensation assists you in measuring relative temperature.

If you are working in a varied environment, where ambient temperature is not constant, do the following:

- 1 Press **Range** for more than one second to enable 0 °C compensation. This function allows a quick measurement of the relative temperature.
- 2 Avoid contact between the thermocouple probe and the measurement surface.
- 3 After a constant reading is obtained, press **ΔNull** to set the reading as the relative reference temperature.
- 4 Touch the measurement surface with the thermocouple probe.
- 5 Read the display for the relative temperature.

NOTE

The T2 temperature measurement is only available for U1242B.

Measuring Harmonic Ratio (U1242B)

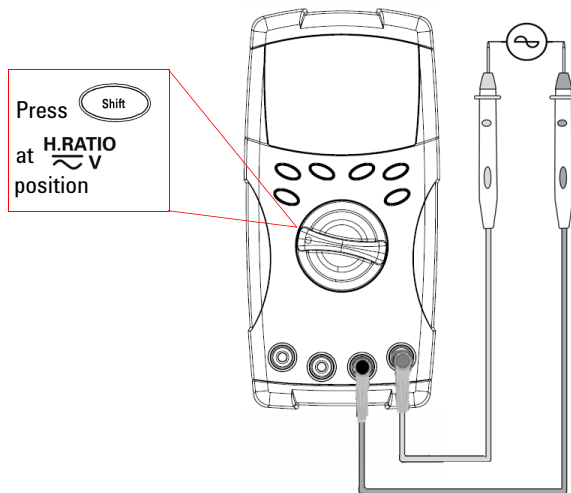

Harmonics ratio function indicates the deviation of non-sinusoidal to sinusoidal waveform from the range of 0% to 100%. A pure sinusoidal waveform without harmonics gives a value of 0.0%.

Alternatively, press **Range** button to display the RMS value of AC voltage. The multimeter will resume back to harmonic ratio value display automatically after 3 seconds.

Using Switch Counter

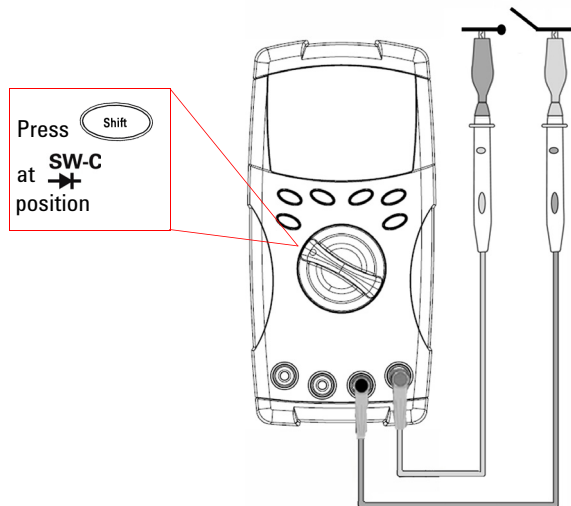

The switch counter is used to check the open/close condition of a switch, relay or push button. The multimeter provides the time base of 10 and 100 seconds, or user-defined time base.

This function detects switch condition in normally close (Low level) or normally open (High level) of a circuit with voltage less than 3 V. The switch counter counts the intermittent for longer than 250 μ sec.







- 1 Remove the power on the contacts or switch before measured.
- 2 Press  at  position to activate the switch counter function. The multimeter will detect the switch condition as shown in [Table 2-7](#).

Table 2-7 Annunciator display for each switch condition

Switch Condition	Circuit Switch	Display
Low Level (< 430 Ω)	Normally close	Lo
Intermittent	Close to open	Number of switch count
Intermittent	Open to close	Number of switch count
High level	Normally open	Hi



- 3 Press  to restart the switch counter, the multimeter will check the current switch condition and set intermittent recognition for the counter.
- 4 Press  to select time base in 10 seconds, 100 seconds or Hand (user-defined). The second display shows **10**, **100** or **HAn** respectively.
- 5 The first intermittent will cause the multimeter to beep and starts to down count the time base. Each intermittent will increase the counter once.
- 6 The counter value and time base are indicated on primary display and secondary display respectively. Press  to start next counting.
- 7 Press  to exit switch counter function.

MinMax Recording

The MinMax operation stores the maximum, minimum, and average input values during a series of measurements. When the input goes below the recorded minimum or maximum value, the multimeter beeps and records the new value. The multimeter also calculates an average of all readings taken since the MinMax mode was activated. From the multimeter's display, you can view the following statistical data for any set of readings:

- **MAX**: highest reading since the MinMax function was enabled
- **MIN**: lowest reading since the MinMax function was enabled
- **AVG**: the average or mean of all the readings since the MinMax function was enabled
- **MAXMINAVG**: present reading (actual input signal value)

Refer to the following steps to use the MinMax Recording mode:



- 1 Press  for more than one second to enter the MinMax Recording mode. The multimeter is now in the continuous mode or non-data hold (non-trigger) mode.
- 2 The beeper sounds when a new maximum or minimum value is recorded.
- 3 Press  to scroll through the maximum, minimum, average, and present readings. The **MAX**, **MIN**, **AVG** or **MAXMINAVG** annunciator lights up correspondingly to the displayed readings.
- 4 Press  for more than one second to exit the MinMax Recording mode.

NOTE

- The average value is the true average of all measured values taken in the MinMax Recording mode.
- If an overload is recorded, the averaging function will stop and the average value becomes **OL** (overload).
- The auto power off feature () is disabled in MinMax Recording mode.



Data Hold (Trigger Hold)

The data hold function allows users to freeze the displayed digital value.

- 1 Press  to freeze the displayed value and to enter manual trigger mode. Notice the **HOLD** annunciator is displayed.
- 2 Press  to trigger the freeze of the next value being measured. The **HOLD** annunciator will flash before the new value is updated onto the display.
- 3 Press  for more than one second to exit this mode.

Refresh Hold

Users are required to activate the Refresh Hold in the setup mode.



- 1 Press  to enter Refresh Hold mode. The present value will be held, and the **HOLD** annunciator is displayed.
- 2 The multimeter is ready to hold new measuring value once the variation of measuring value exceeds the setting of variation count, and the **HOLD** annunciator is flashed.
- 3 The hold value will be updated until the measuring value is stable. The **HOLD** annunciator will stop flashing and stays lit, an audible tone will sound to remind user.
- 4 Press  again to disable this function.

NOTE

- For voltage, current and capacitance measurements, the holding value will not be updated if the reading is below 50 counts.
- For resistance and diode measurements, the holding value will not be updated if the reading is in “OL” (open state).
- The holding value may not be updated if the reading does not reach stable state for all measurements.

Null (Relative)

The Null function subtracts a stored value from the present measurement and displays the difference between the two values.

- 1 Press  to store the displayed reading as the reference value to be subtracted from subsequent measurements and to set the display to zero. The **NULL** annunciator is displayed.
- 2 Press  to view the stored reference value. The **NULL** annunciator will flash for three seconds before the display returns to zero. To exit this mode, press  while **NULL** is flashing on the display.

NOTE

- In resistance measurement, the multimeter reads a non-zero value due to the presence of test leads resistance. Use the Null function to zero-adjust the effect of test lead resistance.
- In DC voltage measurement, the thermal effect will influence the accuracy. Short the test leads and press  once the displayed value is stable in order to zero out the offset.

Data Logging (U1242B)

The data logging function stores the data in non-volatile memory. Thereby, the data remains saved when the multimeter is turned off. Data logging records only the value on primary display. Two options of data logging are offered – Hand (manual) logging and Interval (automatic) logging functions.



Table 2-8 Functions available for data logging

Function	Mode	Range
Voltage	DC, AC	1000 mV to 1000 V
Current	DC, AC, % of mA	1000 μ A to 10 A
Hz	AC	Auto

Function	Mode	Range
Harmonic Ratio	AC	Auto
Ω	Continuity	1000 Ω to 100 M Ω
Diode		1.1 V
Switch Counter		10, 100, HAn
Capacitance		1000 nF to 10 mF
Temperature	T1, T2, T1 – T2,	
Relative		
Recording mode	MAX, MIN, AVG, MAXMINAVG	
HOLD		

Manual Logging

To enable the Hand (manual) logging function, select the Hand logging mode in Setup mode.

- 1 Press  (Log) for more than one second to store the present value and function on primary display to memory.
- 2 Press  (Log) again for the next value that you want to save into memory, see [Figure 2-6](#).

2 Features and Functions

- 3 Press  (Log) for more than one second to exit this mode.

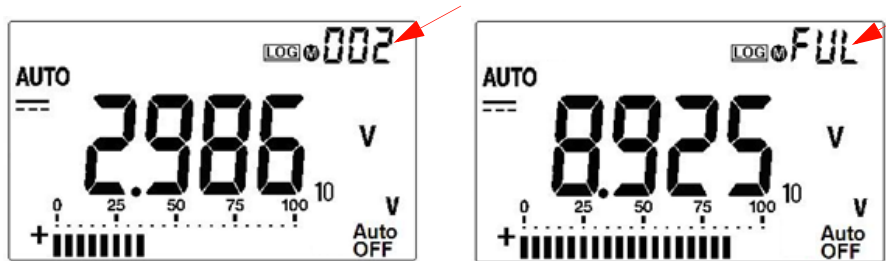



Figure 2-6 Manual logging display

NOTE

Maximum data that can be stored is 100 entries. When the 100 entries are filled, **FUL** annunciator is indicated on the secondary display.

Interval Logging

To enable the Interval (automatic) logging function, select the Interval logging by defining the interval setting in Setup mode.

- 1 Press  (Log) for more than one second to store the present value and function on primary display to memory.
- 2 The reading automatically logs into the memory in every interval as preset in Setup mode, see [Figure 2-7](#).
- 3 Press  (Log) for more than one second to exit this mode.

NOTE

When interval (automatic) logging is enabled, all keypad operation is disabled, except for Log function.

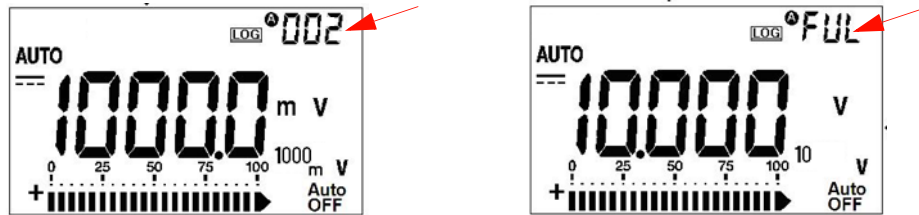

Figure 2-7 Interval logging display

NOTE

Maximum data that can be stored is 200 entries. When the 200 entries are filled, **FUL** annunciator is indicated on the secondary display.

Reviewing Logged Data

- 1 Press **Shift** (View) for more than one second to enter Log View mode. The last recorded entry and last logging index are displayed on the secondary display.
- 2 Press **▲** to ascend or **▼** to descend through logged data. Press **◀** to select the first record and press **▶** to select the last record for quick navigation.
- 3 Press **Shift** to switch between hand (manual) and interval (automatic) logging review mode.
- 4 Press **Shift** (View) for more than one second to exit Log View mode.



Removing Logged Data

Press **Hz** (Log) for more than one second at the respective Log Review mode (hand or interval) to clear all logged data in the memory.

Scanning Temperature Measurement (U1242B)

This scanning temperature measurement function allows users to measure

and display temperature T1, T2 and T1-T2 sequentially.

- 1 Press and hold  (Scan) button for more than one second to enable Scan mode. Notice the multimeter will scan through and display the value of T1, T2 and T1-T2 periodically.
- 2 The multimeter will set to the states for T1, T2 or T1-T2 when you disabled Scan mode by pressing  (Scan) for more than one second.

Checking Battery Capacity

The battery sign  will flash when the battery voltage drops below 4.4 V. Once the low battery sign is displayed, it is highly recommended to replace the batteries immediately. See [Battery Replacement](#) in chapter 4.

To check the battery capacity, see the following steps:

- 1 Press  (Bat) for more than one second to view the battery capacity. The multimeter will resume back to normal function automatically after three seconds.
- 2 The primary display illustrates the flashing **bAt** annunciator and the bar graph indicates the battery capacity in proportional percentage from 4.2 V (0%) to 6.0 V (100%).

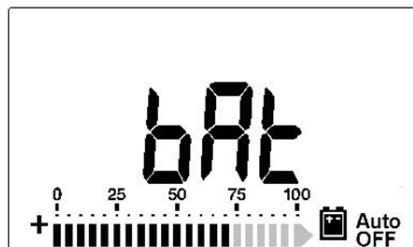

Figure 2-8 Battery capacity display

Alerts and Warning During Measurement

Overload Alert

WARNING

For your safety, please be aware of the alert. When you are alerted, just remove the test leads from the measuring source.

The multimeter provides an overload alert for voltage measurement in both auto and manual range modes. The multimeter beeps periodically once the measuring voltage exceeds 1100.0 V. For your safety, please be aware of this alert.

Input-A Warning Alert

The multimeter sounds an alerting beep when the test lead is inserted to the **A** input terminal but the rotary switch is not set to the corresponding **A** location. The display indicates a flashing **AErr** annunciator until the test lead is removed from the **A** input terminal. This warning alert is not available in T1/T2 temperature measurements mode.

Input-mA Warning Alert

The multimeter sounds an alerting beep when the $\mu\text{A}/\text{mA}$ input terminal detects a voltage level of more than 1.6 V. The display indicates a flashing **CErr** annunciator until the test lead is removed from the $\mu\text{A}/\text{mA}$ input terminal.

2 Features and Functions



3 Default Setting Configurations

Setting Configurations 26

This chapter describes on how to change and configure the default setting of U1241B and U1242B handheld digital multimeters including data logging and other setting features.

Setting Configurations

- 1 Turn off the multimeter.
- 2 From OFF position, press and hold  (Setup) while turning the rotary switch to any non-OFF position.

NOTE

After you hear a beep, the multimeter is in Setup mode and you can release  button.

To change a menu item setting in Setup mode, perform the following steps:











- 1 Press  or  to scroll through menu items.
- 2 Press  or  to scroll through available settings. See [Table 3-9](#) for the details of each available option.
- 3 Press  (Save) to save the changes. These parameters remain in the non-volatile memory.
- 4 Press and hold  (Setup) for more than one second to exit Setup mode.

Table 3-9 Available setting options in Setup mode

Menu item		Available setting options		Default factory setting
Setup	Description	Selection	Description	
rHd	Trigger hold	OFF	Enables Data Hold (manual trigger)	500
		100–1000	Sets variation count that determines Refresh Hold (auto trigger)	
SCA	Percentage scale	0–20 mA, 4–20 mA	Sets % scale readout for 0 to 20 mA or 4 to 20 mA	4–20 mA
FrE	Minimum frequency can be measured	0.5 Hz, 1 Hz, 2 Hz, 5 Hz	Sets the minimum frequency that can be measured in AC measurement mode	0.5 Hz
bEP	Frequency of beep sound	2400 Hz, 1200 Hz, 600 Hz, 300 Hz	Sets frequency of beep sound of the multimeter	2400 Hz
		OFF	Disables beep sound of multimeter	
tñP	Thermocouple	tYPE	Sets thermocouple type to K-type	tYPE K
		tYPE ^[1]	Sets thermocouple type to J-type (for U1242B)	
		tYPE mV	Sets 100 mV measurement for T1 input	
Log	Data logging (for U1242B)	Hand	Enables manual data logging	Hand
		1–9999	Sets interval for automatic data logging from 1 to 9999 seconds. Press  to toggle through the digit to be adjusted.	
APF	Auto power off ^[1]	1–99 m	Sets timer in minutes for auto power off	15 m
		OFF	Disables auto power off	
Lit	Backlight timer	1–99	Sets timer in seconds for auto turn-off for backlight display	15
		OFF	Disables auto turn-off for backlight display	
dAC	Default AC or DC for voltage and current measurements	dC, AC	Defines the preferred setup of AC or DC for voltage and current measurement once multimeter is turned on.	dC
rSt	Reset	dFAU	Resets the multimeter to the factory settings by pressing and holding  for more than 1 second. A beep sound indicates the reset is being done.	dFAU

3 Default Setting Configurations

Menu item		Available setting options		Default factory setting
Setup	Description	Display	Description	
tñP	Temperature ^[2]	d-CF	Sets temperature measurement to °C, pressing  to change measurement unit to °F	d-CF
		d-F	Sets temperature measurement to °F	
		d-FC	Sets temperature measurement to °F, pressing  to change measurement unit to °C	
		d-C	Sets temperature measurement to °C	

[1] To activate the multimeter after it has auto power off, press any button to resume back to respective functional mode.

[2] To view Temperature (**tñP**) menu, press  for more than one second.

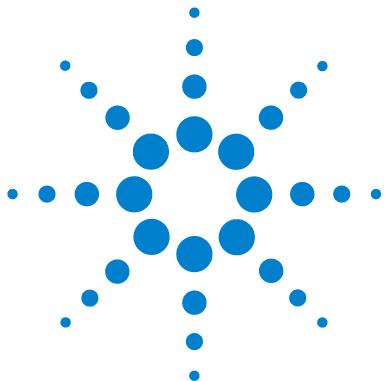

4 Service and Maintenance

General Maintenance	30
Battery Replacement	30
Fuse Replacement	31
Troubleshooting	33
Returning Instrument for Service	35

This chapter provides you with warranty services, maintenance procedures and troubleshooting hints to solve general problems that you may encounter with the instrument. Repair or service which are not covered in this manual should only be performed by qualified personnel.



General Maintenance

WARNING

To avoid electrical shock or damage to the multimeter, ensure no water stays inside the casing.

Besides the above hazard, dirt or moisture in the terminals can distort readings. Cleaning steps are as follows:

- 1 Turn the multimeter off and remove the test leads.
- 2 Turn the multimeter over and shake out any dirt that may have accumulated in the terminals.
- 3 Wipe the case with a damp cloth and mild detergent – do not use abrasives or solvents. Wipe the contacts in each terminal with a clean swab dipped in alcohol.

Battery Replacement

WARNING

Do not discharge the battery by shorting the battery or reverse the battery polarity in any subjects.

CAUTION

To avoid instruments being damage from battery leakage:

- Always remove dead batteries immediately.
 - Always remove the batteries and store them separately if the multimeter is not going to be used for a long period.
-

The multimeter is powered by 6.0 V (1.5 V x 4 batteries) which must be the specified battery type. To ensure that the multimeter performs as specified, it is recommended that you replace the battery as soon as the low battery indicator is flashing. See the following procedures for battery replacement:

- 1 At the rear panel, lift up the stand.
- 2 Loosen the screw on the battery cover.

- 3 Lift and remove the battery cover.
- 4 Replace the specified batteries, ensure the correct polarity of batteries.
- 5 Reverse the procedures of opening the cover to close the battery cover.

Battery Types	ANSI/NEDA	IEC
Alkaline	24A	LR03
Zinc Chloride	24D	R03

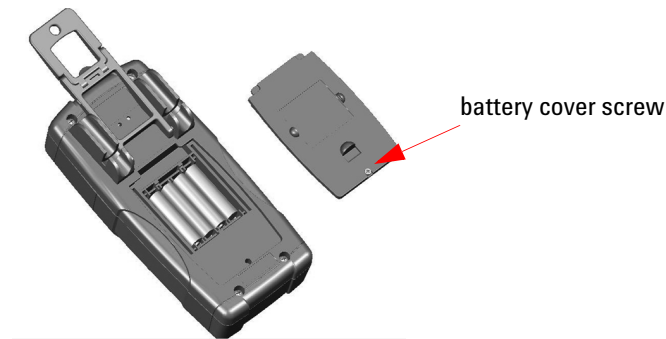

Figure 4-9 Battery replacement

Fuse Replacement

NOTE

Users are recommended to use clean/dry gloves when performing fuse replacement. Do not touch any components except the fuse and plastic parts. No recalibration is required after replacing the fuse.

- 1 Turn off the multimeter and disconnect the test leads from external equipment.
- 2 Loosen four screws on bottom case, lift and remove the cover.

4 Service and Maintenance

- 3 Gently remove the defective Fuse 1 by prying one end of the fuse and removing it out of the fuse bracket, see [Figure 4-10](#).
- 4 Replace a new fuse of the same size and rating into the center of the fuse holder.

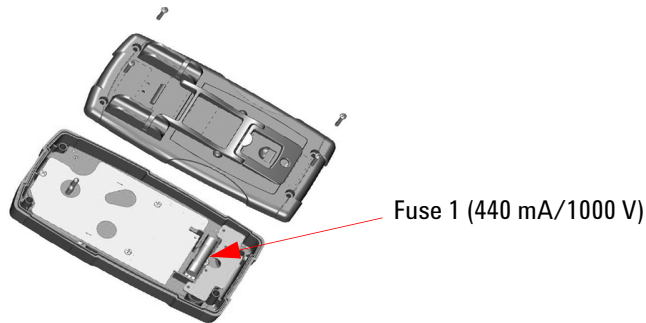

Figure 4-10 Fuse 1 replacement

- 5 If you want to replace a defective Fuse 2, remove Fuse 1 then loosen the four screws (shown in [Figure 4-11](#)) to lift and remove the circuit board from top case.
- 6 Gently remove the defective Fuse 2 by prying one end of the fuse loose and removing it out of the fuse bracket, see [Figure 4-11](#).

Fuse 2 (11 mA/1000 V)

- 7 Replace a new fuse of the same size and rating into the center of the fuse holder.

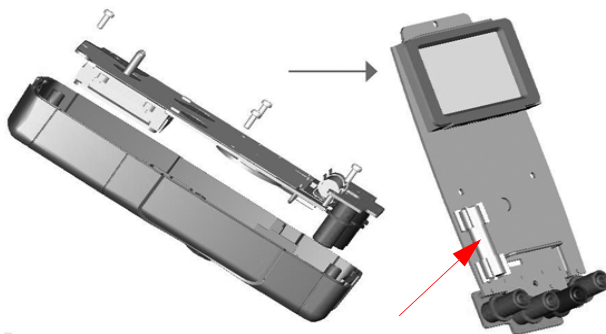

Figure 4-11 Fuse 2 replacement

- 8 Place Fuse 1 back to its original position and then re-fasten the circuit board and the bottom cover respectively.

Troubleshooting

WARNING

To avoid electrical shock, do not perform any service unless you are qualified to do so.

If the instrument fails to operate, check the batteries and test leads, replace them if necessary. If the instrument still does not function, check the identification procedures as described in [Table 4-10](#).

Table 4-10 Basic troubleshooting hints

Malfunction	Identification
No LCD display after power ON	<ul style="list-style-type: none"> Check the battery polarity and replace batteries if necessary. Ensure that the replaced batteries are new batteries, it is recommended not to mix old batteries with new batteries.

4 Service and Maintenance

No beeper tone	<ul style="list-style-type: none">• Check setup mode and verify if the beeper is set to OFF. Then select the desired driving frequency.
Failed on current measurement	<ul style="list-style-type: none">• Check the fuse.

When servicing, use the specified replacement parts only. The [Table 4-11](#) shows the replacement part numbers.

Table 4-11 List of replacement part number

Part number	Description
2110-1400	Fast blow fuse 1000 V, 0.44 A (10 mm x 35 mm)
2110-1402	Fast blow fuse 1000 V, 11 A (10 mm x 35 mm)

Returning Instrument for Service

Before shipping your instrument for repair or replacement, Agilent recommends that you acquire the shipping instructions from the Agilent Technologies Service Center. A clear understanding of the shipping instructions is necessary to secure your product for shipment.

- 1** Write the following information on a tag and if attach to the instrument.
 - Name and address of owner
 - Instrument model number
 - Instrument serial number
 - Description of the service required or failure indications
- 2** Remove all accessories from the instrument. Do not include accessories unless they are associated with the failure symptoms.
- 3** Protect the instrument by wrapping it in plastic or heavy paper.
- 4** Pack the instrument in foam or other shock absorbing material and place it in a strong shipping container.

You are recommended to use the original shipping material or order materials from an Agilent Technologies Sales Office. If both options are not available, place 8 to 10 cm (3 to 4 inches) of shock- absorbing and static-free packaging material around the instrument to avoid movement during shipping.

- 5** Seal the shipping container securely.
- 6** Mark the shipping container as FRAGILE.

In the ensuing correspondence, refer to the instrument by its model number and full serial number.

Agilent suggests that you always insure your shipments.

4 Service and Maintenance

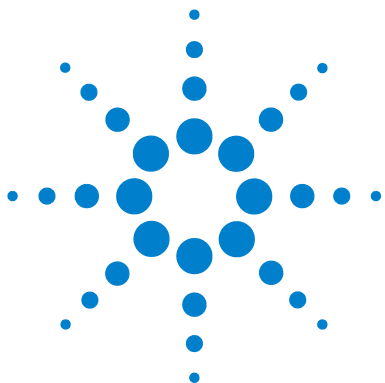

5 Performance Tests and Calibration

Calibration Overview	36
Recommended Test Equipment	38
Basic Operating Test	39
Calibration Process	40
Test Considerations	41
Performance Verification Tests	42
Calibration Security	46
Adjustment Considerations	49
Calibration Adjustments	51
Calibration Count	56
Calibration Errors	56

This chapter contains procedures of performance verification tests and calibration adjustments. The performance tests is meant to verify the U1241B or U1242B handheld digital multimeter to ensure the multimeter is operating within its published specifications.



Calibration Overview

NOTE

Ensure that you have read [Test Considerations](#) before calibrating the multimeter.

Closed-case Electronic Calibration

The multimeter features closed-case electronic calibration. No internal mechanical adjustments are required. The multimeter calculates correction factors based upon the input reference value you set. The new correction factors are stored in non-volatile memory until the next calibration adjustment is performed. Non-volatile EEPROM calibration memory does not change when power has been off.

Calibration Interval

A 1-year interval is adequate for most applications. Accuracy specifications are warranted only if adjustment is made at regular calibration intervals. Accuracy specifications are not warranted beyond the 1-year calibration interval. Agilent does not recommend extending calibration intervals beyond 2 years for any application.

Adjustment is Recommended

Specifications are only guaranteed within the period stated from the last adjustment. Agilent recommends that readjustment should be performed during the calibration process for best performance. This will assure that the U1241B/U1242B will remain within specification. This criteria for re-adjustment provides the best long-term stability.

Performance data is measured during Performance Verification Tests and does not guarantee the multimeter will operate within the test limits unless the adjustment is performed.

Refer to [Calibration Count](#) to verify that all adjustments have been performed.

Recommended Test Equipment

The test equipment recommended for the performance verification and adjustment procedures is listed below. If the exact equipment is not available, substitute the calibration standards of equivalent accuracy.



Table 5-1 Recommended test equipment

Application	Recommended Equipment	Recommended Accuracy Requirements
DC Voltage	Fluke 5520A	<1/5 instrument 1 year specifications
DC Current	Fluke 5520A	<1/5 instrument 1 year specifications
AC Voltage	Fluke 5520A	<1/5 instrument 1 year specifications
AC Current	Fluke 5520A	<1/5 instrument 1 year specifications
Resistance	Fluke 5520A	<1/5 instrument 1 year specifications
Frequency	Fluke 5520A	<1/5 instrument 1 year specifications
Capacitance	Fluke 5520A	<1/5 instrument 1 year specifications
Diode	Fluke 5520A	<1/5 instrument 1 year specifications
Temperature	Fluke 5520A K-type thermal sensor	<1/5 instrument 1 year specifications
Short	Shorting Plug - Dual banana plug with copper wire short between 2 terminals	<1/5 instrument 1 year specifications

Basic Operating Test

Basic Operating Test is used to test the basic operability of the multimeter. Repair is required if the multimeter fails the Basic Operating Test.

Backlight Test

To test the backlight function, press  momentarily to turn backlight ON at medium level of brightness intensity. Press again to toggle the highest level of brightness intensity. The backlight turns OFF automatically after setting period. Alternatively, you can press  for the third time to turn the backlight OFF.

Testing the Display

To view all segments of the display, press and hold the  button while turning the rotary switch from OFF to any non-OFF position. Compare the display with the [Figure 5-1](#).

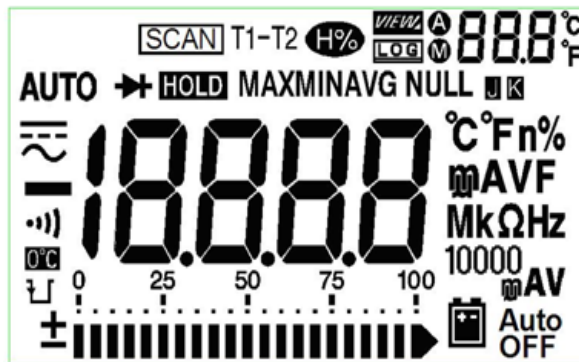

Figure 5-1 Annunciator display

Input-A Terminal Test

This test determines if the input warning of the **A** current terminal test is functioning properly. The multimeter sounds an alerting beep when the test lead is inserted to the **A** input terminal but the rotary switch is not set to the corresponding **A** location. The display indicates a flashing **AErr** annunciator until the test lead is removed from the **A** input terminal. This warning alert is not available in T1/T2 temperature measurements mode.

Input- μ A Terminal Alert Test

This test determines if the detected input voltage level is within the accepted boundaries when the μ A/**mA** input terminal is connected. The multimeter sounds an alerting beep when the μ A/**mA** input terminal detects a voltage level of higher than 1.6 V. The display indicates a flashing **CErr** annunciator until the test lead is removed from the μ A/**mA** input terminal.

NOTE

The alerting beep will not be impacted even if the beep function is disabled.

Calibration Process

- 1 Prior to performing the verification tests, see [Test Considerations](#).
- 2 Perform the verification tests to characterize the multimeter, see [Performance Verification Tests](#).
- 3 Unsecure the multimeter for calibration, see [Calibration Security](#).
- 4 Prior to performing the adjustments, see [Adjustment Considerations](#).
- 5 Perform the adjustment procedures, see [Calibration Adjustments](#).
- 6 Secure the multimeter against unauthorized calibration, see [Exiting Adjustment Mode](#). Ensure that the multimeter has quit the Adjustment Mode and turned off.
- 7 Record the new security code and calibration count in the multimeter's maintenance records.

Test Considerations

Error may be induced by AC signals that present on the input leads. Long test leads can also act as an antenna causing pick-up of AC signals.

For optimum performance, all procedures should comply with the following recommendations:

- Ensure that the calibration ambient temperature is stable and between 18 °C and 28 °C. Ideally the calibration should be performed at 23 °C \pm 2 °C.
- Ensure that the ambient relative humidity (RH) is less than 80%.
- Ensure that the low battery indicator does not appear during the performance verification test. If it does, replace the batteries to avoid any inaccurate reading.
- During temperature performance verification test, ensure that the multimeter has been switched ON and placed in the test environment for at least one hour with J/K-type thermo-couple connected between the multimeter and calibration source.
- Allow one minute warm-up period with a Shorting Plug connected to the V and COM input terminals.
- Use shielded twisted pair PTFE-insulated cables to reduce settling and noise errors. Keep the input cables as short as possible.
- Connect the input cable shields to earth ground. Except where noted in the procedures, connect the calibrator **LO** source to earth ground at the calibrator. It is important that the **LO** to earth ground connection be made at only one place in the circuit to avoid ground loops.

During DC voltage, DC current, and resistance gain verification measurements, ensure that the calibrator's "0" output is correct. It is recommended to set the offset for each range of the measuring function being verified.

Input Connections

Test connections to the multimeter are best accomplished using the K-type thermocouple wire and mini-connectors for temperature measurement. The J-type thermocouple wire and mini-connectors can also be used for temperature measurements (for U1242B). Shielded, twisted-pair, PTFE interconnect cables of minimum length are recommended between the calibrator and the multimeter. Cable shields should be earth ground referenced. This configuration is recommended for optimal noises and settling time performance during calibration.

Performance Verification Tests





The performance verification tests are recommended as acceptance tests when you first receive the multimeter. The acceptance test results should be compared against the one year test limits. After acceptance, you should repeat the performance verification tests at every calibration interval.

If the multimeter fails performance verification, adjustment or repair is required.



NOTE





Users are highly recommended to read the [Test Considerations](#) before performing performance verification tests.

Table 5-2 Verification Tests

Step	Test Function	Range	5520A Output	Error from nominal 1 year	
				U1241B	U1242B
1	Turn the rotary switch to  V position	1000 mV	1000.0 mV	± 1.4 mV	
		10 V	10.000 V	± 11 mV	
		100 V	100.00 V	± 110 mV	
		1000 V	1000.0 V	± 2 V	
2	Press  to go to  V function	1000 mV	1000.0 mV, 500 Hz	± 10.5 mV	
			1000.0 mV, 1 kHz	± 20.5 mV	
		10 V	10.000 V, 500 Hz	± 105 mV	
			10.000 V, 1 kHz	± 105 mV	
			10.000 V, 2 kHz	± 205 mV	
		100 V	100.00 V, 500 Hz	± 1.05 V	
			100.00 V, 1 kHz	± 1.05 V	
			100.00 V, 2 kHz	± 2.05 V	
1000 V	1000.0 V, 1 kHz	± 10.5 V			
3	Press  to go to frequency mode	100 Hz	1.000 V, 70 Hz	± 51 mHz	
		1000 Hz	1.000 V, 1000 Hz	± 600 mHz	
		10 kHz	1.000 V, 2 kHz	± 3.6 Hz	
4	Turn the rotary switch to  position	Diode	1.000 V	± 5 mV	

5 Performance Tests and Calibration

Step	Test Function	Range	5520A Output	Error from nominal 1 year	
				U1241B	U1242B
5	Turn the rotary switch to Ω position	1000 Ω	1000.0 Ω	$\pm 3.3 \Omega$ ^[1]	
		10 k Ω	10.000 k Ω	$\pm 33 \Omega$ ^[1]	
		100 k Ω	100.00 k Ω	$\pm 330 \Omega$	
		1000 k Ω	1000.0 k Ω	$\pm 3.3 \text{ k}\Omega$	
		10 M Ω	10.000 M Ω	$\pm 83 \text{ k}\Omega$	
		100 M Ω	100.00 M Ω	$\pm 1.53 \text{ M}\Omega$ ^[2]	
6	Turn the rotary switch to $\rightarrow $ position	1000 nF	1000.0 nF	$\pm 12.4 \text{ nF}$	
		10 μF	10.000 μF	$\pm 0.124 \mu\text{F}$	
		100 μF	100.00 μF	$\pm 1.24 \mu\text{F}$	
		1000 μF	1000.0 μF	$\pm 20.4 \mu\text{F}$	
		10 mF	10.000 mF	0.204 mF	
7	Turn the rotary switch to $\mu\text{A} \sim$ position	1000 μA	1000.0 μA	$\pm 1.3 \mu\text{A}$	
		10000 μA	10000 μA	$\pm 13 \mu\text{A}$	
8	Press  to go to $\sim \mu\text{A}$ function	1000 μA	1000.0 μA , 500 Hz	$\pm 10.5 \mu\text{A}$	
			1000.0 μA , 1 kHz	$\pm 15.5 \mu\text{A}$	
		10000 μA	10000 μA , 500 Hz	$\pm 105 \mu\text{A}$	
			10000 μA , 1 kHz	$\pm 155 \mu\text{A}$	
9	Turn the rotary switch to $\text{mA} \sim$ position	100 mA	100.0 mA	$\pm 0.23 \text{ mA}$	
		440 mA	400.0 mA ^[3]	$\pm 2.3 \text{ mA}$	
10	Press  to go to $\sim \text{mA}$ function	100 mA	100.00 mA, 500 Hz	$\pm 1.05 \text{ mA}$	
			100.00 mA, 1 kHz	$\pm 1.55 \text{ mA}$	
		440 mA	400 mA ^[3] , 500 Hz	$\pm 4.5 \text{ mA}$	
			400 mA ^[3] , 1 kHz	$\pm 6.5 \text{ mA}$	

Step	Test Function	Range	5520A Output	Error from nominal 1 year	
				U1241B	U1242B
11	Turn the rotary switch to A  position	10 A	10.000 A ^[4]	± 65 mA	
12	Press  to go to  A function	10 A	10.000 A ^[4] , 500 Hz	± 105 mA	
		10 A	10.000 A ^[4] , 1 kHz	± 155 mA	
13	Turn the rotary switch to T1 or T1T2 ^[5] position	-40 °C until 1000 °C ^[6]	-40 °C	± 1.4 °C	
			0 °C	± 1 °C	
			1000 °C	± 11 °C	
14	Press  to go to T2 function ^[5]	-40 °C until 1000 °C ^[6]	-40 °C		± 1.4 °C
			0 °C		± 1 °C
			1000 °C		± 11 °C

[1] The accuracy of 1 kΩ and 10 kΩ are specified after Math Null, that is used to substrate the test lead resistance and the thermal effect.

[2] For the range of 100 MΩ, the RH is specified for <60%.

[3] Current can be measured from 50 mA to 440 mA continuously. An addition of 0.2% to the specified accuracy when measuring a signal greater than 440 mA to 1100 mA for 30 seconds maximum. After measuring > 440 mA current, cool down the multimeter for twice the measuring time taken before proceed for low current measurement.

[4] Current can be measured from 0.5 A up to 10 A continuously with the maximum operating temperature of 50 °C. An addition 0.3% needs to be added to the specified accuracy if the signal measured is in the range of 10 A to 19.999 A for 15 seconds maximum. After measuring a current of > 10 A, leave the multimeter to cool down for 60 seconds before applying low current measurement.

[5] Only available in U1242B.

[6] The multimeter should be ON for at least 1 hour before measurements are taken. The accuracy does not include the tolerance of thermocouple probe. When measuring temperature with respect to any temperature calibrator, set both the calibrator and multimeter with external reference (without internal ambient compensation 0 °C). If both calibrator and multimeter are set with internal reference (with internal ambient compensation), deviation may be present between the readings of the calibrator and multimeter.

Calibration Security

The calibration security code prevents accidental or unauthorized adjustments to the multimeter. The multimeter is secured when the multimeter is shipped from factory. Before performing any adjustment to the multimeter, you are required to unsecure the multimeter by entering the correct security code (see [Unsecuring the Multimeter for Calibration](#)). The security code may contain up to 4 numeric characters.









NOTE

You can unsecure and change the security code from the multimeter front panel. If you forget your security code, see [Unsecuring the Multimeter Without the Security Code](#).







Unsecuring the Multimeter for Calibration

Before performing adjustment to the multimeter, you are required to unsecure the multimeter by entering the correct security code. The security code is set to 1234 when the multimeter is shipped from the factory. The security code is stored in non-volatile memory, and does not change when power is off.









Unsecuring the Multimeter from the Front Panel

- 1 Turn the rotary switch to .
- 2 Press  and  simultaneously to enter the Calibration Security Code entry mode. The primary display shows **5555** and the secondary display shows **SEU**.
- 3 Press  or  to step each character in the code. Press  or  to change the value of the selected character.
- 4 Press  (Save) when done.
- 5 If the correct security code is entered, the secondary display will show **"PAS"**. If an invalid code is entered, the multimeter will show error code **"E02"** on the secondary display for approximately 3 seconds and return to the Calibration Security entry mode.

Changing the Multimeter Calibration Security Code from the Front Panel

- 1 When the multimeter is in the unsecured mode, press  button for more than one second to enter Calibration Security Code setting mode.
- 2 The factory default calibration security code 1234 will be displayed on primary display.
- 3 Press  or  to step each character in the code. Press  or  to change the value of the selected character.
- 4 Press  (Save) button, to store new calibration security code.
- 5 If the new calibration security code has been successfully stored, the secondary display will show PASS. If the new code failed to save, the multimeter will show error code **E07** on the secondary display for approximately 3 seconds and return to the Calibration Security Code setting mode.

Unsecuring the Multimeter Without the Security Code

- 1 Record the last 4 digit serial numbers of the multimeter.
- 2 Turn the rotary switch to .
- 3 Press  and  simultaneously to enter the Calibration Security Code entry mode. The primary display shows **5555** and the secondary display shows **SEC**.
- 4 Press  for more than one second to enter Set Default Security Code mode. The secondary display shows **SEr** and primary display shows “**5555**”.
- 5 Press  or  to step each character in the code. Press  and  to change the value of the selected character.
- 6 Set the code, same as the last 4 digit serial number of the multimeter. Press  (Save) to confirm the entry.
- 7 If the 4 digit serial number entered is correct, the secondary display will show **PAS**. If an invalid code is entered, the multimeter will show

error code **E03**. Ensure that the last 4 digit serial number is entered correctly and repeat the step 1 to 7.





Using the Front Panel for Adjustments

This section describes the process used to perform adjustments from the front panel.

Selecting the Adjustment Mode

Unsecure the multimeter, see [Unsecuring the Multimeter for Calibration](#) or [Unsecuring the Multimeter Without the Security Code](#). Once the multimeter has been unsecured, the reference value will be indicated on the primary display.

Entering Adjustment Values

- 1 Press  and  to step through each character in the primary display.
- 2 Press  and  to change the value of the corresponding character from digits 0 through 9.
- 3 Apply the respective corresponding input signal from the recommended test equipment in [Table 5-1](#).
- 4 Press  (Save) when done to start calibration.

NOTE

Ensure that the accuracy of the input signal adheres to the [Valid Adjustment Input Values](#) in [Table 5-3](#).

Adjustment Considerations

NOTE

After each adjustment, the secondary display shows **PAS**. If the calibration fails, the multimeter beeps, and an error number is shown in the secondary display. Calibration error messages are described in [Calibration Errors](#).

- 1 Allow the multimeter to warm up and stabilize for five minutes before performing the adjustments.
- 2 Assure that the low battery indicator does not appear during the adjustment. Replace the batteries to avoid inaccurate readings.
- 3 Consider the thermal effects of the test leads connected to the calibrator and multimeter. It is recommended to wait for one minute before start performing the calibration.
- 4 During ambient temperature adjustment, ensure that the multimeter has been turned on for at least one hour with K-type thermocouple connected between the multimeter and calibration source.







CAUTION

Do not turn off the multimeter during adjustments., as this may delete the calibration memory for the present function.

Valid Adjustment Input Values

Adjustment can be accomplished using the following input values below.

Table 5-3 Valid adjustment input values

Function	Range	Valid Input Reference Values
 V	1000 mV, 10 V, 100 V, 1000 V	0.9 to 1.1 x Full Scale
 V	1000 mV, 10 V, 100 V, 1000 V	0.9 to 1.1 x Full Scale
 1 V	1 V	0.9 to 1.1 x Full Scale
Ω	1000 Ω , 10 k Ω , 100 k Ω , 1000 k Ω , 10 M Ω	0.9 to 1.1 x Full Scale
	1000 nF, 10 μ F, 100 μ F, 1000 μ F, 10 mF	0.9 to 1.1 x Full Scale
μ A 	1000 μ A, 10000 μ A	0.9 to 1.1 x Full Scale
mA 	100 mA, 1000 mA	0.9 to 1.1 x Full Scale
A 	10 A	0.9 to 1.1 x Full Scale
T1	0 °C	Ensure that 0 °C with ambient compensation is provided
DCmV (T1)	100 mV	0.9 to 1.1 x Full Scale

CAUTION



The minimum AC current output of Fluke 5520A calibrator is 29 μ A. Ensure that at least 50 μ A is set at the calibrator source of AC μ A.

Calibration Adjustments

NOTE

Review the [Test Considerations](#) and [Adjustment Considerations](#) before beginning the adjustment procedures.

- 1 Turn the rotary switch to **Test Function** position, as shown in [Table 5-3](#).
- 2 After unsecuring the multimeter, the multimeter will go into the adjustment mode, see [Unsecuring the Multimeter for Calibration](#).
- 3 The primary display will show the reference value of the Cal Items. Configure each Cal Item shown in Valid Adjustment Input Reference Values in [Table 5-3](#).

- 4 Use the  and  arrow keys to select the Cal Range.
- 5 Apply the input signal as shown in the **Valid Input Reference Value** column of the [Table 5-3](#). The bar graph will display the input reading. There is no bar graph display for temperature adjustment.

NOTE

Users are highly recommended to complete the adjustments in the same order as shown in [Table 5-3](#).

- 6 Enter the actual applied input, see [Entering Adjustment Values](#).
- 7 Press  to start the adjustments. The **CAL** flashes in the secondary display indicating the calibration is in progress.
- 8 Upon completion of each adjustment value, the secondary display will show **PAS**. If the adjustment failed, the multimeter will sound a long beep and the calibration error number appears in the secondary display. The primary display remains at the current Cal Item.



NOTE



If the adjustment failed, check the input value, range, function, and entered adjustment value and repeat the adjustment steps.

5 Performance Tests and Calibration





- 9 Turn the rotary switch to the next function according to the **Test Function** column shown in [Table 5-3](#). Repeat steps 3 to 8 for each adjustment point shown in the calibration adjustment, see [Table 5-4](#).
- 10 Verify the adjustments using the [Performance Verification Tests](#).





Table 5-4 Calibration Adjustments

Step	Test Function	Cal Range	Input Reference Value	Cal Item	
				U1241B	U1242B
1	Turn the rotary switch to  V position	Short	Dual banana plug with copper wires short between two terminals	SHrt	
		1000 mV	1 V	1000.0 mV	
		10 V	10 V	10.000 V	
		100 V	100 V	100.00 V	
		1000 V	1000 V	1000.0 V	
2	Press  to go to  V function	1000 mV	30 mV, 70 Hz	30.0 mV	
			1000 mV, 70 Hz	1000.0 mV	
			1000 mV, 1 kHz	1000.0 mV	
		10 V	1 V, 70 Hz	1.000 V	
			10 V, 70 Hz	10.000 V	
			10 V, 1 kHz	10.000 V	
		100 V	10 V, 70 Hz	10.00 V	
			100 V, 70 Hz	100.00 V	
			100 V, 1 kHz	100.00 V	
		1000 V	100 V, 70 Hz	100.0 V	
			1000 V, 70 Hz	1000.0 V	
			1000V, 1 kHz	1000.0 V	



Step	Test Function	Cal Range	Input	Cal Item	
				U1241B	U1242B
3	Turn the rotary switch to  position	Short	Dual banana plug with copper wires short between two terminals	SHrt	
		1 V	1 V	1.000 V	
4	Turn the rotary switch to Ω position	Short	Dual banana plug with copper wires short between two terminals	SHrt	
		10 M Ω	Input terminals open (remove all test leads and shorting plugs from input terminals)	oPEn	
			10 M Ω	10.000 M Ω	
		1000 k Ω	1000 k Ω	1000.0 k Ω	
		100 k Ω	100 k Ω	100.00 k Ω	
		10 k Ω	10 k Ω	10.000 k Ω	
		1000 Ω	1000 Ω	1000 Ω	
5	Turn the rotary switch to  position	Open	Input terminals open (remove all test leads and shorting plugs from input terminals)	oPEn	
		1000 nF	400 nF	400.0 nF	
			1000 nF	1000.0 nF	
		10 μ F	10 μ F	10.000 μ F	
		100 μ F	100 μ F	100.00 μ F	
		1000 μ F	1000 μ F	1000.0 μ F	
	10 mF	10 mF	10.000 mF		

5 Performance Tests and Calibration

Step	Test Function	Cal Range	Input	Cal Item	
				U1241B	U1242B
6	Turn the rotary switch to μA  position	Open	Input terminals open (remove all test leads and shorting plugs from input terminals)	oPEn	
		1000 μA	1000 μA	1000.0 μA	
		10000 μA	10000 μA	10000 μA	
7	Press  to go to $\sim \mu\text{A}$ function	1000 μA	50 μA , 70 Hz	50.0 μA	
			100 μA , 70 Hz	100.0 μA	
			1000 μA , 70 Hz	1000.0 μA	
		10000 μA	1000 μA , 70 Hz	1000 μA	
			10000 μA , 70 Hz	10000 μA	
8	Turn the rotary switch to mA  position	Open	Input terminals open (remove all test leads and shorting plugs from input terminals)	oPEn	
		100 mA	100 mA	100.00 mA	
		1000 mA	320 mA	320.0 mA	
9	Press  to go to $\sim \text{mA}$ function	100 mA	5 mA, 70 Hz	5.00 mA	
			10 mA, 70 Hz	10.00 mA	
			100 mA, 70 Hz	100.00 mA	
		1000 mA	100 mA, 70 Hz	100.0 mA	
			320 mA, 70 Hz	320.0 mA	

Step	Test Function	Cal Range	Input	Cal Item	
				U1241B	U1242B
Move the test lead from “μA.mA” and “COM” terminal to “A” and “COM” terminal					
Caution: Connect the calibrator to the multimeter's “A” and “COM” terminal before applying 10 A					
10	Turn the rotary switch to A  position	Open	Input terminals open (remove all test leads and shorting plugs from input terminals)	oPEn	
		10 A	10 A	10.000 A	
11	Press  to go to  A function	10 A	0.5 A, 70 Hz	0.500 A	
			1 A, 70 Hz	1.000 A	
			10 A, 70 Hz	10.000 A	
12	Turn the rotary switch to T1 or T1T2 position	Short	Dual banana plug with copper wires short between two terminals	SHrt	
		100 mV	100 mV	100.00 mV	
13	Press  to go to T1 function	K-type	0 °C	000.0 °C	



Exiting Adjustment Mode

- 1 Remove all shorting plugs and connectors from the multimeter.
- 2 Record the new Calibration Count, see [Calibration Count](#).
- 3 Press  and  simultaneously to exit the Adjustment Mode. Power off and on the multimeter to return to normal measurement mode and secured.

Calibration Count

The multimeter provides the calibration count information for users to access through front panel operation. Note that the multimeter was calibrated prior to shipping out to users. Users are recommended to record the initial value of the calibration count once receiving the multimeter.

The count value increases by one for each calibration point, from 0000 up to the maximum of 19999. After the maximum count, the calibration count will be reset to 0. The calibration count can be read from the front panel after the multimeter has been unsecured, see the following steps:

- 1 In adjustment mode, press and hold  for more than one second to view the calibration count viewing mode. The primary display indicates the calibration count value while the secondary display indicates “Cnt”.
- 2 Take note of the calibration count to keep track of the number of calibration counts that has been performed.
- 3 Press and hold  for more than one second to exit the calibration count mode.

Calibration Errors

The following error codes indicate failures that may occur during a calibration. The error code is displayed on secondary display.

Table 5-5 Calibration error codes

Code	Descriptions
200	Calibration error: Calibration mode is secured
E02	Calibration error: Invalid secure code
E03	Calibration error: Invalid serial number code
E04	Calibration error: Calibration aborted
E05	Calibration error: Value out of range
E06	Calibration error: Signal measurement out of range
E07	Calibration error: Frequency out of range
E08	EEPROM write failure

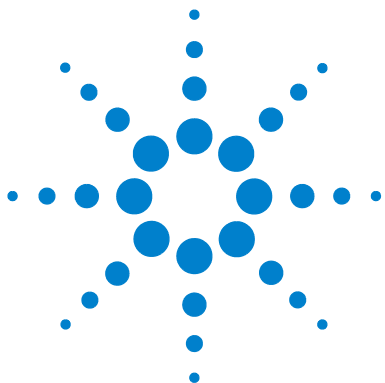

6 Specifications and Characteristics

DC Specifications	58
AC Specifications	59
Resistance Specifications	60
Diode Check/Audible Continuity Test Specifications	60
Temperature Specifications	61
Capacitance Specifications	62
Harmonic Ratio Specifications	62
Frequency Specifications	63
Operating Specifications	64
General Characteristics	65

This chapter lists specifications and characteristics of the U1241B and U1242B handheld digital multimeters. These specifications apply when using the multimeter in an environment that is *free* of electromagnetic interference and electrostatic charge.

When using the multimeter in an environment where electromagnetic interference or significant electrostatic charge is present, measurement accuracy may be reduced.



DC Specifications

Table 6-6 DC specifications with accuracy of \pm (% of reading + No. of Least Significant Digit)

Function	Range	Resolution	Test Current/ Burden Voltage	Accuracy	
				U1241B	U1242B
Voltage ^[1]	1000.0 mV	0.1 mV	-	0.09% + 5	
	10.000 V	0.001 V	-	0.09% + 2	
	100.00 V	0.01 V	-		
	1000.0 V	0.1 V	-	0.15% + 5	
Current	1000.0 μ A	0.1 μ A	< 0.06 V	0.1%+3	
	10000 μ A	1 μ A	< 0.55 V	0.1%+3	
	100.00 mA	0.01 mA	< 0.18 V	0.2%+3	
	440.0 mA ^[2]	0.1 mA	< 0.8 V	0.5%+3	
	10.000 A ^[3]	0.001 A	< 0.4 V	0.6%+5	

[1] Input impedance: 10 M Ω (nominal).

[2] Current can be measured up to 440 mA continuously. An additional 0.2% needs to be added to the specified accuracy if the signal measured is in the range of 440 mA to 1100 mA for 30 seconds maximum. After measuring current of > 440 mA, leave the multimeter to cool down for twice the measuring time used before application of low current measurement.

[3] Current can be measured up to 10 A continuously with the maximum operating temperature of 50 °C. An additional 0.3% needs to be added to the specified accuracy if the signal measured is in the range of 10 A to 19.999 A for 15 seconds maximum. After measuring a current of > 10 A, leave the multimeter to cool down for 60 seconds before applying low current measurement.

AC Specifications

Table 6-7 AC specifications with accuracy of \pm (% of reading + No. of Least Significant Digit)

Function	Range	Resolution	Test Current/ Burden Voltage	Accuracy		
				40 Hz to 500 Hz	500 Hz to 1 kHz	1 kHz to 2 kHz
AC Voltage ^{[1][2]} True RMS	1000.0 mV	0.1 mV	–	1% + 5	2% + 5	-
	10.000 V	0.001 V	–		1% + 5	2% + 5
	100.00 V	0.01 V	–			
	1000.0 V	0.1 V	–			–
AC Current ^[2] True RMS	1000.0 μ A	0.1 μ A	< 0.06 V	1% + 5	1.5% + 5	–
	10000 μ A	1 μ A	< 0.55 V			
	100.00 mA	0.01 mA	< 0.18 V			
	440.0 mA ^[3]	0.1 mA	< 0.8 V			
	10.000 A ^[4]	0.001 A	< 0.4 V			

[1] Input impedance: 10 M Ω (nominal) in parallel with <100 pF, with overload protection of 1000 V R.M.S.

[2] ACV and AC μ A/mA/A specifications are true RMS AC coupled, valid from 5% to 100% of range. The crest factor may up to 3 at full scale and for 1000 V range, the crest factor is 1.5 at full scale. For non-sinusoidal waveforms with crest factor \leq 3, add 2% reading + 2% full scale *typical*.

[3] Current can be measured from 50 mA to 440 mA continuously. An additional 0.2% needs to be added to the specified accuracy if the signal measured is in the range of 440 mA to 1100 mA for 30 seconds maximum. After measuring current of > 440 mA, leave the multimeter to cool down for twice the measuring time used before application of low current measurement.

[4] Current can be measured from 0.5 A up to 10 A continuously with the maximum operating temperature of 50 °C. An additional 0.3% needs to be added to the specified accuracy if the signal measured is in the range of 10 A to 19.999 A for 15 seconds maximum. After measuring a current of >10 A, leave the multimeter to cool down for 60 seconds before applying low current measurement.

Resistance Specifications

Table 6-8 Resistance specifications with accuracy of \pm (% of reading + No. of Least Significant Digit)

Function	Range	Resolution	Test Current/ Burden Voltage	Accuracy
Resistance ^[1]	1000.0 Ω ^[2]	0.1 Ω	0.5 mA	0.3% + 3
	10.000 k Ω ^[2]	0.001 k Ω	50 μ A	
	100.00 k Ω	0.01 k Ω	4.91 μ A	
	1000.0 k Ω	0.1 k Ω	447 nA	
	10.000 M Ω	0.001 M Ω	112 nA	0.8% + 3
	100.00 M Ω ^[3]	0.01 M Ω	112 nA	1.5% + 3

Diode Check/Audible Continuity Test Specifications

Table 6-9 Diode test/audible continuity test specifications with accuracy of \pm (% of reading + No. of Least Significant Digit)

Function	Range	Resolution	Test Current/ Burden Voltage	Accuracy
Diode test ^[4]	1 V	0.001 V	Approximately 0.5 mA	0.3% + 2

[1] The maximum open voltage is < 2.8 V. For instant continuity, the built-in buzzer sounds when resistance is <10% of each resistance range.

[2] The accuracy of 1 k Ω and 10 k Ω is specified after Null function, which is used to substrate the test lead resistance and the thermal effect.

[3] For the range of 100 M Ω , the R.H. is specified for < 60%. The temperature coefficient will be 0.15 times of specified accuracy as > 50 M Ω .

[4] Overload protection: 1000 V R.M.S. for circuits < 0.3 A short circuit current. The built-in buzzer sounds when reading is approximately below 50 mV and audible single tone for normal forward biased diode or semiconductor junction as 0.3 V \leq Reading \leq 0.8 V.

Temperature Specifications

Table 6-10 Temperature specifications with accuracy of \pm (% of reading + offset error)

Function	Thermocouple Type	Range	Resolution	Accuracy ^[1]
Temperature ^[2]	K	-40 °C to 1000 °C	0.1 °C	1% + 1 °C
		-40 °F to 1832 °F	0.1 °F	1% + 1.8 °F
	J ^[3]	-40 °C to 1000 °C	0.1 °C	1% + 1 °C
		-40 °F to 1832 °F	0.1 °F	1% + 1.8 °F

[1] The accuracy is specified as following condition:

- The accuracy does not include the tolerance of thermocouple probe. The thermal sensor plugged into the multimeter should be placed in the operating environment for at least one hour.
- Use Null function to reduce the thermal effect.
- When measuring temperature with respect to any temperature calibrator, set both the calibrator and multimeter with external reference (without internal ambient compensation). If both calibrator and multimeter are set with internal reference (with internal ambient compensation), deviation may be shown between the readings of the calibrator and multimeter, due to differences in ambient compensation between calibrator and multimeter.
- Do not contact the temperature sensor to any surface that is energized above 33 Vrms or 70 VDC, such the voltage source will pose a shock hazard.

[2] The temperature calculation is according to the standard of EN/IEC-60548-1 and NIST175.

[3] Only available in U1242B.

Capacitance Specifications

Table 6-11 Capacitance specifications with accuracy of \pm (% of reading + No. of Least Significant Digit)

Function	Range	Resolution	Accuracy
Capacitance ^[1]	1000.0 nF	0.1 nF	1.2 % + 4
	10.000 μ F	0.001 μ F	
	100.00 μ F	0.01 μ F	
	1000.0 μ F	0.1 μ F	2% + 4
	10.000 mF	0.001 mF	

[1] Use the null operation to zero out residual offset before measuring the signal (by opening the test leads).

Harmonic Ratio Specifications

Table 6-12 Harmonics ratio specifications

Function	Range ^[2]	Frequency	Voltage
Harmonic ratio	0.0% – 99.9%	40 Hz – 500 Hz	100 mVAC – 1000 VAC

[1] Overload protection: 1000 V R.M.S. for circuits < 0.3 A short circuit current. The accuracy is calculated based on the film capacitor. Use Relative mode for residual value.

[2] Pure sinusoidal waveforms without harmonics have a harmonics ratio of 0%, higher the harmonics ratio, more harmonics are present in the sinusoidal waveform.

Frequency Specifications

Table 6-13 Frequency specifications with accuracy of \pm (% of reading + No. of Least Significant Digit)

Function	Range	Resolution	Accuracy	Min. Input Frequency
Frequency ^[1]	100.00 Hz	0.01 Hz	0.03% + 3	1 Hz
	1000.0 Hz	0.1 Hz		
	10.000 kHz	0.001 kHz		
	100.00 kHz	0.01 kHz		
	1000.00 kHz	0.1 kHz		

Frequency Sensitivity During Voltage Measurement^[2]

Input Range (Maximum input for specified accuracy = 10 x Range or 1000 V)	Minimum Sensitivity (R.M.S. sine wave)	
	20 Hz to 50 kHz	50 kHz to 200 kHz
1000.0 mV	0.3 V	0.6 V
10.000 V	0.5 V	1.8 V
100.00 V	5 V	10 V (<100 kHz)
1000.0 V	50 V	100 V (<100 kHz)

Frequency Sensitivity During Current Measurement^[3]

Input Range	Minimum Sensitivity (R.M.S. Sine wave)
	20 Hz – 20 kHz
1000.0 μ A	100 μ A
10000 μ A	500 μ A
100.00 mA	10 mA
440.0 mA	50 mA
10.000 A	1 A

[1] The input signal is lower than the product of 20,000,000 V-Hz.

[2] For the accuracy of the maximum input, refer to AC voltage specifications.

[3] For the accuracy of the maximum input, refer to AC current specifications.

Operating Specifications

Table 6-14 Measuring rate of U1241B and U1242B

Function	Times/second
ACV	7
DCV (V or mV)	7
Ω	14
Diode	14
Capacitance	4 (< 100 μ F)
DCA (μ A, mA, A)	7
ACA (μ A, mA, A)	7
Temperature	7 (single)
Frequency	1 (>10 Hz)

General Characteristics

Table 6-15 General characteristics of U1241B and U1242B

Power Supply
<ul style="list-style-type: none"> 4 single standard 1.5 V AAA batteries (Alkaline or Zinc Chloride type)
Display
<ul style="list-style-type: none"> Dual display (secondary display is cater for temperature function display only) are 4-digit liquid crystal display (LCD) with maximum reading of 11,000 counts. Automatic polarity indication.
Power Consumption
<ul style="list-style-type: none"> 0.22 VA maximum
Operating Environment
<ul style="list-style-type: none"> Full accuracy at $-10\text{ }^{\circ}\text{C}$ to $55\text{ }^{\circ}\text{C}$ Full accuracy to 80% R.H. for temperature up to $30\text{ }^{\circ}\text{C}$, decreasing linearly to 50% R.H. at $55\text{ }^{\circ}\text{C}$
Storage Environment
<ul style="list-style-type: none"> $-20\text{ }^{\circ}\text{C}$ to $70\text{ }^{\circ}\text{C}$, with battery removed
Altitude
<ul style="list-style-type: none"> 0 – 2000 meters per IEC 61010-1 2nd Edition CAT III, 1000 V/ CAT IV, 600 V
Safety Compliance
<ul style="list-style-type: none"> IEC 61010-1:2001 / EN61010-1:2001 USA: UL 61010-1:2004 Canada: CSA C22.2 No. 61010-1:2004
Measurement Category
<ul style="list-style-type: none"> CAT III, 1000 V/ CAT IV, 600 V Overvoltage Protection, Pollution degree 2
EMC Compliance
<ul style="list-style-type: none"> Certified to IEC 61326-1:2005/ EN 61326-1:2006 Canada: ICES/NMB-001:2004 Australia/New Zealand: AS/NZS CISPR11:2004
Common Mode Rejection Ratio (CMRR)
<ul style="list-style-type: none"> $> 90\text{ dB}$ at DC, 50/60 Hz $\pm 0.1\%$ (1 kΩ unbalanced)
Normal Mode Rejection Ratio (NMRR)
<ul style="list-style-type: none"> $> 60\text{ dB}$ at 50/60 Hz $\pm 0.1\%$
Temperature Coefficient
<ul style="list-style-type: none"> $0.1 \times$ (specified accuracy) / $^{\circ}\text{C}$ (from $-10\text{ }^{\circ}\text{C}$ to $18\text{ }^{\circ}\text{C}$ or $28\text{ }^{\circ}\text{C}$ to $55\text{ }^{\circ}\text{C}$)
Crest Factor
<ul style="list-style-type: none"> ≤ 3.0
Shock and Vibration
<ul style="list-style-type: none"> Tested to IEC/EN 60068-2
Dimension (HxWxD)
<ul style="list-style-type: none"> 193.8 mm x 92.2 mm x 58 mm

Weight

- 450 g with batteries
- 400 g without batteries

Warranty

- Please refer to http://www.agilent.com/go/warranty_terms
 - Three years for the product
 - Three months for the product's standard accessories, unless otherwise specified
 - Please take note that for the product, the warranty does not cover:
 - Damage from contamination
 - Normal wear and tear of mechanical components
 - Manuals, fuses, and standard disposable batteries
-

www.agilent.com

Contact us

To obtain service, warranty or technical support assistance, contact us at the following phone numbers:

United States:

(tel) 800 829 4444 (fax) 800 829 4433

Canada:

(tel) 877 894 4414 (fax) 800 746 4866

China:

(tel) 800 810 0189 (fax) 800 820 2816

Europe:

(tel) 31 20 547 2111

Japan:

(tel) (81) 426 56 7832 (fax) (81) 426 56 7840

Korea:

(tel) (080) 769 0800 (fax) (080) 769 0900

Latin America:

(tel) (305) 269 7500

Taiwan:

(tel) 0800 047 866 (fax) 0800 286 331

Other Asia Pacific Countries:

(tel) (65) 6375 8100 (fax) (65) 6755 0042

Or visit Agilent worldwide web at:

www.agilent.com/find/assist

Product specifications and descriptions in this document subject to change without notice. Always refer to Agilent Web site for the latest revision.

© Agilent Technologies, Inc. 2009 – 2012

Printed in Malaysia

Fourth Edition, June 22, 2012

U1241-90063



Agilent Technologies