

# **Fluke 19xB-19xC-2x5C**

ScopeMeter

models 192B,196B,199B,192C,196C,199C,215C,225C

## Service Manual

PN 4822 872 05391  
September 2002, rev.2, Oct.09  
© 2002-2009 Fluke Corporation, All rights reserved.  
All product names are trademarks of their respective companies.

## **PLACING ORDERS AND GETTING ASSISTANCE**

To locate an authorized service center, visit us on the World Wide Web:

**<http://www.fluke.com>**

or call Fluke using any of the phone numbers listed below:

+1-888-993-5853 in U.S.A. and Canada

+31-40-2675200 in Europe

+1-425-446-5500 from other countries

# Table of Contents

Chapter	Title	Page
<b>1</b>	<b>Safety Instructions.....</b>	<b>1-1</b>
	1.1 Introduction.....	1-3
	1.2 Safety Precautions.....	1-3
	1.3 Caution and Warning Statements.....	1-3
	1.4 Symbols .....	1-3
	1.5 Impaired Safety.....	1-4
	1.6 General Safety Information.....	1-4
<b>2</b>	<b>Characteristics .....</b>	<b>2-1</b>
<b>3</b>	<b>List of Replaceable Parts .....</b>	<b>3-1</b>
	3.1 Introduction.....	3-3
	3.2 How to Obtain Parts.....	3-3
	3.3 Final Assembly Parts .....	3-4
	3.4 Main PCA Unit Parts .....	3-6
	3.5 Accessories .....	3-8
<b>4</b>	<b>Performance Verification .....</b>	<b>4-1</b>
	4.1 Introduction.....	4-3
	4.2 Equipment Required For Verification .....	4-3
	4.3 General Instructions .....	4-3
	4.4 Operating Instructions.....	4-4
	4.4.1 Resetting the test tool .....	4-4
	4.4.2 Navigating through menu's .....	4-4
	4.4.3 Creating Test Tool Setup1 .....	4-5
	4.5 Display and Backlight Test.....	4-5
	4.6 Scope Input A&B Tests .....	4-7
	4.6.1 Input A&B Vertical Accuracy Test .....	4-7
	4.6.2 Input A&B DC Voltage Accuracy Test.....	4-9
	4.6.3 Input A&B AC Voltage Accuracy Test (LF) .....	4-11
	4.6.4 Input A & B AC Coupled Lower Frequency Test.....	4-12
	4.6.5 Input A and B Peak Measurements Test.....	4-13
	4.6.6 Input A&B Frequency Measurement Accuracy Test .....	4-14
	4.6.7 Input A&B Phase Measurements Test.....	4-15
	4.6.8 Time Base Test .....	4-16
	4.6.9 Input A Trigger Sensitivity Test.....	4-17
	4.6.10 Input A AC Voltage Accuracy (HF) & Bandwidth Test .....	4-19
	4.6.11 Input B Trigger Sensitivity Test.....	4-20
	4.6.12 Input B AC Voltage Accuracy (HF) & Bandwidth Test .....	4-21
	4.6.13 Video test using the Video Pattern Generator .....	4-22

4.6.14	Video test using SC600 Scope Calibration Option .....	4-24
4.7	External Trigger Level Test .....	4-27
4.8	Meter (DMM) Tests .....	4-28
4.8.1	Meter DC Voltage Accuracy Test .....	4-28
4.8.2	Meter AC Voltage Accuracy & Frequency Response Test .....	4-29
4.8.3	Continuity Function Test .....	4-30
4.8.4	Diode Test Function Test .....	4-30
4.8.5	Ohms Measurements Test .....	4-30
4.9	Probe Calibration Generator Test .....	4-32
<b>5</b>	<b>Calibration Adjustment .....</b>	<b>5-1</b>
5.1	General .....	5-3
5.1.1	Introduction .....	5-3
5.1.2	Calibration number and date .....	5-3
5.1.3	General Instructions .....	5-3
5.1.4	Equipment Required For Calibration .....	5-4
5.2	Calibration Procedure Steps .....	5-4
5.3	Starting the Calibration .....	5-4
5.4	Contrast Calibration Adjustment .....	5-6
5.5	Warming Up & Pre-Calibration .....	5-7
5.6	Final Calibration .....	5-8
5.6.1	Input A LF-HF Gain .....	5-8
5.6.2	Input B LF-HF Gain .....	5-9
5.6.3	Input A&B LF-HF Gain .....	5-11
5.6.4	Input A&B Position .....	5-12
5.6.5	Input A&B Volt Gain .....	5-13
5.6.6	DMM Volt Gain .....	5-14
5.6.7	Input A & B, and DMM Zero .....	5-15
5.6.8	DMM Ohm Gain .....	5-16
5.6.9	Calculate Gain .....	5-17
5.7	Save Calibration Data and Exit .....	5-17
5.8	Probe Calibration .....	5-19
<b>6</b>	<b>Disassembling the Test Tool .....</b>	<b>6-1</b>
6.1	Introduction .....	6-3
6.2	Disassembly & Reassembly Procedures .....	6-3
6.2.1	Required Tools .....	6-3
6.2.2	Removing the Tilt Stand & Hang Strap .....	6-3
6.2.3	Replacing the Side-Strap, Changing the Side-Strap Position .....	6-3
6.2.4	Opening the Test Tool, Removing the Battery .....	6-3
6.2.5	Removing the Main PCA Unit and the Fan .....	6-5
6.2.6	Removing the Display Assembly .....	6-6
6.2.7	Replacing the LCD Window/Decal .....	6-7
6.2.8	Removing the Keypad and Keypad Foil .....	6-7
6.2.9	Disassembling the Main PCA Unit .....	6-7
6.2.10	Reassembling the Main PCA Unit .....	6-8
6.2.11	Reassembling the Test Tool .....	6-9

# List of Tables

Table	Title	Page
3-1.	Final Assembly Parts .....	3-4
3-2.	Main PCA Unit Parts .....	3-6
3-3.	Standard Accessories .....	3-8
3-5.	Optional Accessories .....	3-9
4-1.	Vertical Accuracy Verification Points .....	4-8
4-2.	Volts DC Measurement Verification Points .....	4-10
4-4.	Input A&B AC Input Coupling Verification Points .....	4-13
4-5.	Volts Peak Measurement Verification Points .....	4-14
4-6.	Input A&B Frequency Measurement Accuracy Test .....	4-15
4-7.	Phase Measurement Verification Points .....	4-16
4-8.	Input A Trigger Sensitivity Test Points .....	4-18
4-9.	HF AC Voltage Verification Points .....	4-19
4-11.	HF AC Voltage Verification Points .....	4-21
4-12.	Meter Volts dc Measurement Verification Points .....	4-28
4-13.	Meter Volts AC Measurement Verification Points .....	4-29
4-14.	Resistance Measurement Verification Points .....	4-31
5-1.	Input A HF-LF Gain Calibration Points .....	5-9
5-2.	Input B LF-HF Gain Calibration Points .....	5-10
5-3.	Input A&B Gain Calibration Points .....	5-12
5-4.	Input A&B Gain Calibration Points .....	5-14
5-5.	DMM Gain Calibration Points .....	5-15
5-6.	Ohm Gain Calibration Points .....	5-17



# List of Figures

Figure	Title	Page
3-1.	Final Assembly Details.....	3-5
3-2.	Main PCA Unit.....	3-7
3-3.	Rubber Spacer on Shielding Box Assy.....	3-7
4-1.	Menu item selection.....	4-4
4-2.	Display Test Pattern .....	4-6
4-3.	Test Tool Input A&B to 5500 Normal Output .....	4-7
4-4.	5500 Scope Output to Test Tool Input A&B.....	4-14
4-5.	5500A Scope Output to Test Tool Input A.....	4-16
4-7.	5500A Scope Output to Test Tool Input B.....	4-20
4-8.	Test Tool Input A to TV Signal Generator.....	4-22
4-9.	Trace for PAL/SECAM line 622 .....	4-23
4-10.	Trace for NTSC line 525 .....	4-23
4-11.	Trace for PAL/SECAM line 310 .....	4-23
4-12.	Trace for NTSC line 262 .....	4-23
4-13.	Test Tool Input A to TV Signal Generator Inverted.....	4-24
4-14.	Trace for PAL/SECAM line 310 Negative Video .....	4-24
4-15.	Trace for NTSC line 262 Negative Video .....	4-24
4-16.	Test Tool Input A to TV Signal Generator.....	4-25
4-17.	SC600 Marker Pulse .....	4-26
4-18.	Test Tool Meter/Ext Input to 5500A Normal Output.....	4-27
4-19.	Test Tool Input A to 5500A Normal Output 4-Wire.....	4-31
5-1.	Version & Calibration Data.....	5-3
5-2.	Display Test Pattern .....	5-7
5-3.	5500A SCOPE Output to Test Tool Input A .....	5-8
5-4.	5500A SCOPE Output to Test Tool Input B .....	5-10
5-5.	Test tool Input A&B to 5500 Scope Output.....	5-11
5-6.	Test tool Input A&B to 5500 Normal Output.....	5-13
5-7.	5500A NORMAL Output to Test Tool Banana Input.....	5-15
5-8.	Four-wire Ohms calibration connections.....	5-16
5-9.	10:1 Probe Calibration Connection .....	5-19
5-10.	10:1 Probe Calibration.....	5-19
6-1.	Loosen 2 Input Cover Screws.....	6-4
6-2.	Loosen 2 Bottom Holster Screws .....	6-4
6-3.	Opening the Test Tool .....	6-4
6-4.	Removing the Battery Pack .....	6-4
6-5.	Final Assembly Details.....	6-5
6-6.	Flex Cable Connectors .....	6-6
6-7.	PCA Unit Assembly .....	6-8

# **Chapter 1**

## ***Safety Instructions***

<b>Title</b>	<b>Page</b>
1.1 Introduction.....	1-3
1.2 Safety Precautions.....	1-3
1.3 Caution and Warning Statements.....	1-3
1.4 Symbols .....	1-3
1.5 Impaired Safety.....	1-4
1.6 General Safety Information.....	1-4

## 1.1 Introduction

Read these pages carefully before beginning to install and use the test tool.

The following paragraphs contain information, cautions and warnings which must be followed to ensure safe operation and to keep the test tool in a safe condition.

### Warning

**Servicing described in this manual is to be done only by qualified service personnel. To avoid electrical shock, do not service the test tool unless you are qualified to do so.**

## 1.2 Safety Precautions

For the correct and safe use of this test tool it is essential that both operating and service personnel follow generally accepted safety procedures in addition to the safety precautions specified in this manual. Specific warning and caution statements, where they apply, will be found throughout the manual. Where necessary, the warning and caution statements and/or symbols are marked on the test tool.

## 1.3 Caution and Warning Statements

### Caution











**Used to indicate correct operating or maintenance procedures to prevent damage to or destruction of the equipment or other property.**

### Warning

**Calls attention to a potential danger that requires correct procedures or practices to prevent personal injury.**

## 1.4 Symbols

The following symbols are used on the test tool, in the Users Manual, in this Service Manual, or on spare parts for this test tool.

	See explanation in Users Manual		DOUBLE INSULATION (Protection Class)
	Live voltage		Earth Ground
	Static sensitive components (black/yellow).	 Ni MH	Recycling information
	Do not dispose of this product as unsorted municipal waste. Go to Fluke's website for recycling information.		Conformité Européenne
	Safety Approval		Safety Approval

## **1.5 Impaired Safety**

Whenever it is likely that safety has been impaired, the test tool must be turned off and disconnected from line power. The matter should then be referred to qualified technicians. Safety is likely to be impaired if, for example, the test tool fails to perform the intended measurements or shows visible damage.

## **1.6 General Safety Information**

### **Warning**

**Removing the test tool covers or removing parts, except those to which access can be gained by hand, is likely to expose live parts and accessible terminals which can be dangerous to life.**

The test tool shall be disconnected from all voltage sources before it is opened.

Capacitors inside the test tool can hold their charge even if the test tool has been separated from all voltage sources.

When servicing the test tool, use only specified replacement parts.

## **Chapter 2**

# **Characteristics**

**For the specifications please refer to the ScopeMeter test tool Users Manual Chapter “Specifications”.**



# **Chapter 3**

## ***List of Replaceable Parts***

<b>Title</b>	<b>Page</b>
3.1 Introduction.....	3-3
3.2 How to Obtain Parts.....	3-3
3.3 Final Assembly Parts .....	3-4
3.4 Main PCA Unit Parts .....	3-6
3.5 Accessories .....	3-8

### **3.1 Introduction**

This chapter contains an illustrated list of replaceable parts for the ScopeMeter test tool. Parts are listed by assembly; alphabetized by item number. Each assembly is accompanied by an illustration showing the location of each part and its item number. The parts list gives the following information:

- Item number
- Description
- Ordering code

### **3.2 How to Obtain Parts**

Contact an authorized Fluke service center.

To locate an authorized service center refer to the second page of this manual (back of the title page).

In the event that the part ordered has been replaced by a new or improved part, the replacement will be accompanied by an explanatory note and installation instructions, if necessary.

To ensure prompt delivery of the correct part, include the following information when you place an order:

- Instrument model (for example Fluke-196C), 12 digit instrument code (9444 ... ..), and serial number (DM.....). The items are printed on the type plate on the bottom cover.
- Ordering code
- Item number
- Description
- Quantity

### 3.3 Final Assembly Parts

See Table 3-1 and Figure 3-1 for the Final Assembly parts.

Table 3-1. Final Assembly Parts

Item	Description	Ordering Code
1	Top case assembly (without LCD, without window/decal)	1638248
2	Display window/decal Fluke 192B	2042440
	Display window/decal Fluke 192C	3402263
	Display window/decal Fluke 196B	2042457
	Display window/decal Fluke 196C	2042478
	Display window/decal Fluke 199B	2042469
	Display window/decal Fluke 199C	2042484
	Display window/decal Fluke 215C	3402256
	Display window/decal Fluke 225C	3402239
3 + 4	Keypad set (includes large & small keypad) 19x (Lowest yellow key = RECORDER)	1638180
	Keypad set (includes large & small keypad) 2x5 (Lowest yellow key = ANALYZE)	3402242
5	Keypad foil	1642199
6	Keypad support assembly	1638253
7	Display unit Color Fluke 192C, 196C, 199C, 215C, 225C	1638230
	Display unit B/W Fluke 192B, 196B, 199B <i>Remark: The Display unit does not include the flat cable</i>	2042528
	Flat cable for display unit (both versions)	2042596
8	Display mounting frame assy	1668063
9	Input cover (including screws)	1285765
10	EJOT Pt screw	1284966
11	Main PCA unit; The Main PCA is only available to Fluke Service Centers due to the programming that is necessary after installation.	-
12	Hang strap	1286041
13	Bottom case assembly (see note 2 below)	1285783
14	Combi-screw Torx M3x10 (screw + split spring)	1285046
15	Strap	1285923
16	Strap holder	1285938
17	Tilt stand (bail)	1285945
18	Combi-screw Torx M3x10 (screw + flat washer)	1285079
19	Bottom holster	1285752
20	Combi-screw Torx M3x10 (screw + flat washer)	1285079
21	Battery Pack (see note 3 below)	BP190
22	Spacer M2.5x3 for Fan	1638770
23	Fan Assy	1638294
24	Screw M2.5x12, countersunk Torx for Fan	1639787

Note



The test tool contains a NiMH battery (item 21). Do not mix with the solid wastestream. Spent batteries should be disposed of by a qualified recycler or hazardous materials handler.

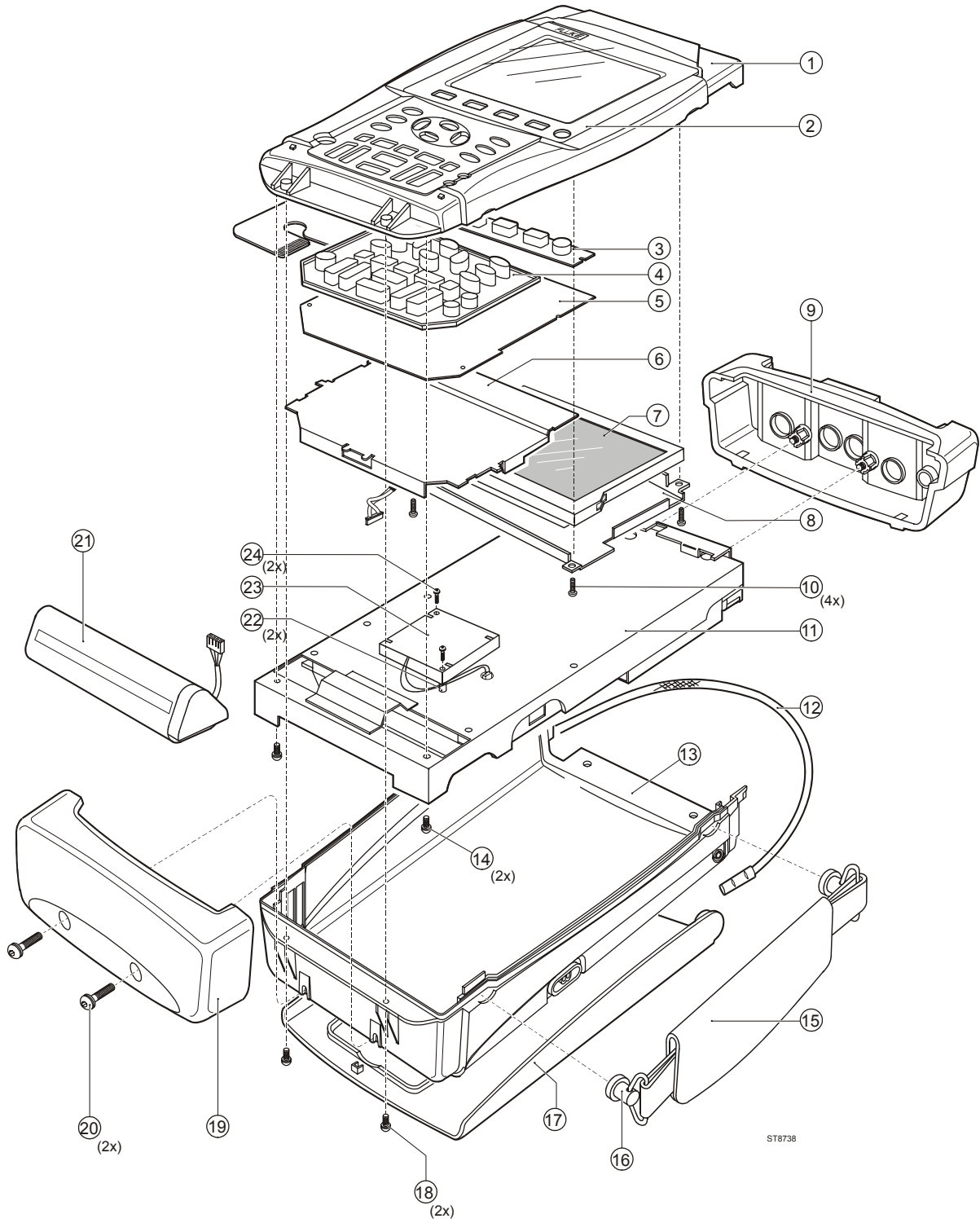

Figure 3-1. Final Assembly Details

st8738.wmf

### 3.4 Main PCA Unit Parts

See Table 3-2 and Figure 3-2 for the main PCA Unit parts.

**Table 3-2. Main PCA Unit Parts**

Item	Description	Ordering Code
1	Shielding box assy (includes rubber spacer, see fig. 8-5)	1665767
2	Insulation foil	1285961
3	PT-Screw K35x8	1284975
4	Input connector unit	1285977
5	Sealing ring for power connector	1286052
6	Input attenuator shielding: - METER channel top - METER channel bottom - SCOPE channel A top - SCOPE channel B top - SCOPE channel A&B bottom	1285989 1285992 1286007 1286018 1286029
7	Screw Torx M3x20	1285101
8	Shielding cover	1286034
9	Combi-screw Torx M3x10 (screw + split spring)	1285046
10	Hexagonal spacer M3x16.5	1285199

*Note*

*The Scope channel A and B input attenuator top shieldings are provided with a plate spring. The spring end is provided with heat conducting tape; it contacts the C-ASIC's N1000 and N1200, and transports the heat from the C-ASIC to the shielding.*

*Do not bend the springs, keep the tape on the spring end free of dust, and put the shielding on the correct position.*

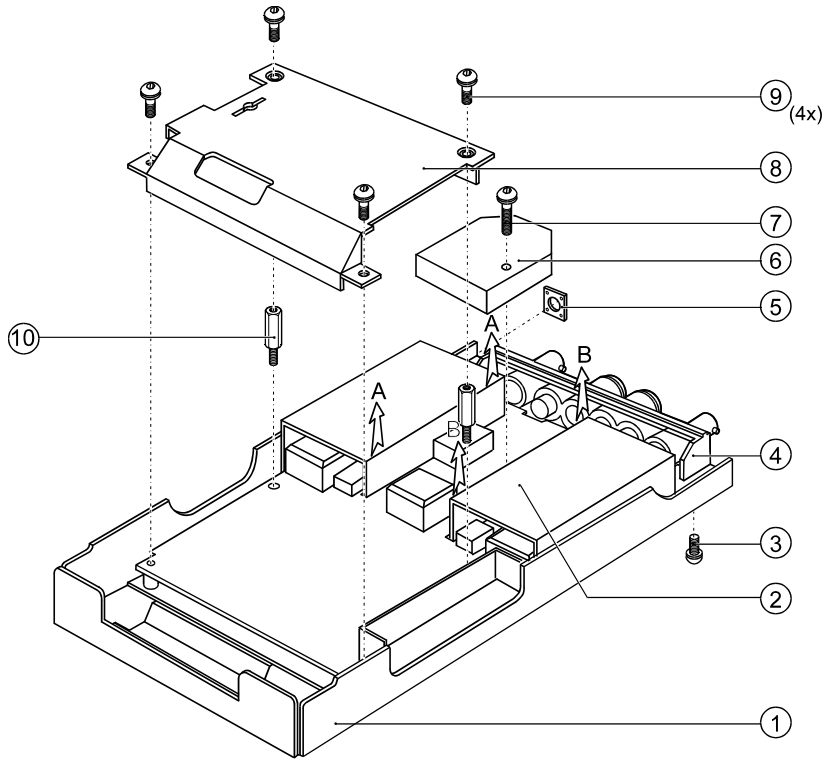

ST8676

ST8676.wmf

**Figure 3-2. Main PCA Unit**

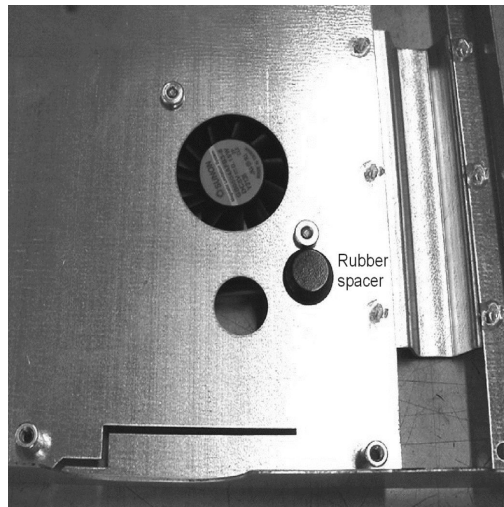

rubber-spacer-16gray.jpg

**Figure 3-3. Rubber Spacer on Shielding Box Assy**

### 3.5 Accessories

Table 3-3. Standard Accessories

Item	Ordering Code
Battery Charger, available models: Universal Europe 230 V, 50 and 60 Hz North America 120 V, 50 and 60 Hz United Kingdom 240 V, 50 and 60 Hz Japan 100 V, 50 and 60 Hz Australia 240 V, 50 and 60 Hz Universal 115 V/230 V, 50 and 60 Hz <i>The universal adapter is standard equipped with a plug EN60320-2.2G. For connection to the mains outlet use a line plug that complies with National Standards. The 230V rating of the BC190/808 is not for use in North America.</i>	BC190/801 BC190/813 BC190/804 BC190/806 BC190/807 BC190/808
Voltage Probe Set (Red), designed for use with the Fluke ScopeMeter 190 series test tool. The set includes the following items (not available separately): <ul style="list-style-type: none"> <li>• 10:1 Voltage Probe (red)</li> <li>• 4-mm Test Probe for Probe Tip (red)</li> <li>• Hook Clip for Probe Tip (red)</li> <li>• Ground Lead with Hook Clip (red)</li> <li>• Ground Lead with Mini Alligator Clip (black)</li> <li>• Ground Spring for Probe Tip (black)</li> </ul>	VP210-R <i>See Note below</i>
Voltage Probe Set (Gray), designed for use with the Fluke ScopeMeter 190 series test tool. The set includes the following items (not available separately): <ul style="list-style-type: none"> <li>• 10:1 Voltage Probe (gray)</li> <li>• 4-mm Test Probe for Probe Tip (gray)</li> <li>• Hook Clip for Probe Tip (gray)</li> <li>• Ground Lead with Hook Clip (gray)</li> <li>• Ground Lead with Mini Alligator Clip (black)</li> </ul>	VP210-G <i>See Note below</i>
Test Lead Set	TL75
Accessory Set (Red) The set includes the following items (not available separately): <ul style="list-style-type: none"> <li>• Industrial Alligator for Probe Tip (red)</li> <li>• 2-mm Test Probe for Probe Tip (red)</li> <li>• Industrial Alligator for Banana Jack (red)</li> <li>• 2-mm Test Probe for Banana Jack (red)</li> <li>• Ground Lead with 4-mm Banana Jack (black)</li> </ul>	AS200-R
Accessory Set (Gray) The set includes the following items (not available separately): <ul style="list-style-type: none"> <li>• Industrial Alligator for Probe Tip (gray)</li> <li>• 2-mm Test Probe for Probe Tip (gray)</li> <li>• Industrial Alligator for Banana Jack (gray)</li> <li>• 2-mm Test Probe for Banana Jack (gray)</li> <li>• Ground Lead with 4-mm Banana Jack (black)</li> </ul>	AS200-G
Replacement Set for Voltage Probe VP200 The set includes the following items (not available separately): <ul style="list-style-type: none"> <li>• 2x , 4-mm Test Probe for Probe Tip (red and gray)</li> <li>• 3x , Hook Clip for Probe Tip (2 red, 1 gray)</li> <li>• 2x , Ground Lead with Hook Clip (red and gray)</li> <li>• 2x , Ground Lead with Mini Alligator Clip (black)</li> <li>• 5x Ground Spring for Probe Tip (black)</li> </ul>	RS200

*Note:*

*From May 2007 the VPS200 probe sets have been replaced with the VPS210 probe sets. The specifications of the VPS210 and the VPS200 probes are identical. The AS200 accessory sets can be used for the VP200 as well as for the VPS210 probe sets.*

**Table 3-4. Optional Accessories**

Item	Ordering Code
Software & Cable Carrying Case Kit Set contains the following parts:	SCC190
• Optically Isolated USB Cable	OC4USB
• Hard Carrying Case	C190
• FlukeView™ ScopeMeter Software for Windows®	SW90W
Optically Isolated RS-232 Adapter/Cable	PM9080
Optically Isolated USB Cable	OC4USB
Hard Case	C190
Soft Case	C195
Current Shunt 4-20 mA	CS20MA
Print Adapter Cable for Parallel Printers	PAC91
Bus Health Test Adapter (for Fluke 215C-225C)	BHT190



## **Chapter 4**

# **Performance Verification**

<b>Title</b>	<b>Page</b>
4.1 Introduction.....	4-3
4.2 Equipment Required For Verification .....	4-3
4.3 General Instructions.....	4-3
4.4 Operating Instructions.....	4-4
4.4.1 Resetting the test tool .....	4-4
4.4.2 Navigating through menu's .....	4-4
4.4.3 Creating Test Tool Setup1 .....	4-5
4.5 Display and Backlight Test.....	4-5
4.6 Scope Input A&B Tests .....	4-7
4.6.1 Input A&B Vertical Accuracy Test .....	4-7
4.6.2 Input A&B DC Voltage Accuracy Test.....	4-9
4.6.3 Input A&B AC Voltage Accuracy Test (LF) .....	4-11
4.6.4 Input A & B AC Coupled Lower Frequency Test.....	4-12
4.6.5 Input A and B Peak Measurements Test.....	4-13
4.6.6 Input A&B Frequency Measurement Accuracy Test .....	4-14
4.6.7 Input A&B Phase Measurements Test.....	4-15
4.6.8 Time Base Test .....	4-16
4.6.9 Input A Trigger Sensitivity Test.....	4-17
4.6.10 Input A AC Voltage Accuracy (HF) & Bandwidth Test .....	4-19
4.6.11 Input B Trigger Sensitivity Test.....	4-20
4.6.12 Input B AC Voltage Accuracy (HF) & Bandwidth Test .....	4-21
4.6.13 Video test using the Video Pattern Generator .....	4-22
4.6.14 Video test using SC600 Scope Calibration Option .....	4-24
4.7 External Trigger Level Test.....	4-27
4.8 Meter (DMM) Tests.....	4-28
4.8.1 Meter DC Voltage Accuracy Test .....	4-28
4.8.2 Meter AC Voltage Accuracy & Frequency Response Test .....	4-29
4.8.3 Continuity Function Test.....	4-30
4.8.4 Diode Test Function Test .....	4-30
4.8.5 Ohms Measurements Test .....	4-30
4.9 Probe Calibration Generator Test .....	4-32



## 4.1 Introduction

### Warning

**Procedures in this chapter should be performed by qualified service personnel only. To avoid electrical shock, do not perform any servicing unless you are qualified to do so.**

The ScopeMeter® test tool (referred to as test tool) should be calibrated and in operating condition when you receive it.

The following performance tests are provided to ensure that the test tool is in a proper operating condition. If the test tool fails any of the performance tests, calibration adjustment (see Chapter 5) and/or repair is necessary.

The Performance Verification Procedure is based on the specifications, see Chapter 2 of this Service Manual. The values given here are valid for ambient temperatures between 18 °C and 28 °C.

The Performance Verification Procedure is a quick way to check most of the test tool's specifications. Because of the highly integrated design of the test tool, it is not always necessary to check all features separately.

## 4.2 Equipment Required For Verification

The primary source instrument used in the verification procedures is the Fluke 5500A. If a 5500A is not available, you can substitute another calibrator as long as it meets the minimum test requirements.

- Fluke 5500A Multi Product Calibrator, including SC300 or SC600 Oscilloscope Calibration Option.
- Stackable Test Leads (4x), supplied with the 5500A.
- 50Ω Coax Cables (2x), Fluke PM9091 (1.5m) or PM9092 (0.5m).
- Male BNC to Dual Female BNC adapter (1x), Fluke PM9093/001
- 50Ω feed through termination, Fluke PM9585.
- Dual Banana Plug to Female BNC Adapter (1x), Fluke PM9081/001.
- Dual Banana Jack to Male BNC Adapter (1x), Fluke PM9082/001.
- TV Signal Generator, Philips PM5418, NOT required if SC600 Oscilloscope Calibration Option is used.
- 75Ω Coax cable (1x), Fluke PM9075.
- 75Ω Feed through termination (1x), ITT-Pomona model 4119-75.

## 4.3 General Instructions





Follow these general instructions for all tests:

- For all tests, power the test tool with the BC190 power adapter/battery charger. The battery pack must be installed.
- Allow the 5500A to satisfy its specified warm-up period.
- For each test point, wait for the 5500A to settle.
- Allow the test tool a minimum of 30 minutes to warm up.
- One division on the LCD consists of 25 pixels ( 1 pixel = 0.04 division).

## 4.4 Operating Instructions

### 4.4.1 Resetting the test tool





Proceed as follows to reset the test tool:

- Press  to turn the test tool off.
- Press and hold .
- Press and release  to turn the test tool on.
- Wait until the test tool has **beeped twice**, and then release . When the test tool has beeped twice, the RESET was successful.

### 4.4.2 Navigating through menu's

During verification you must open menus, and to choose items from the menu.

Proceed as follows to make choices in a menu :

- Reset the test tool
- Open a menu, for example press , then press  (**READING 1**). The menu as showed in Figure 4-1 will be opened.  
Active functions are marked by , inactive functions by .  
If more than one menu groups are available, they will be separated by a vertical line.  
The menu you opened indicates that **READING 1** (that is the upper left reading) shows the result of a V ac+dc measurement ( **V ac+dc**) on Input A ( **on A**).
- Press  or  to highlight the function to be selected.
- Press  (**ENTER**) to confirm the selection.  
The active function in the next menu group will be highlighted now. If the confirmation was made in the last (most right) menu group, the menu will be closed.

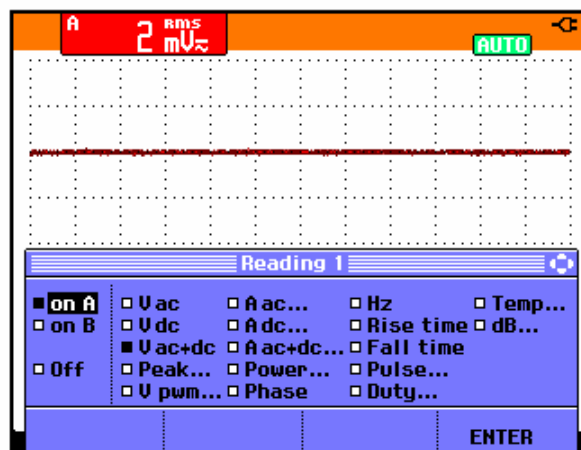



















Figure 4-1. Menu item selection

ws-read1.bmp

### 4.4.3 Creating Test Tool Setup1



Before starting the verification procedure you must define a standard test tool setup, called SETUP 1. During verification you will be asked to recall this setup. This defines the initial test tool setup for each verification.

Proceed as follows to create SETUP1:

1. Reset the test tool. Input A is ON, Input B is OFF now.
2. Press  . The inverse text indicates the actual settings.
3. Press  (toggle key) to select **INPUT B ON**. The Input B trace will become visible.
4. Press  to change the **PROBE B** setting.
5. Select **Probe Type: ■ Voltage | Attenuation: ■ 1:1** .
6. Press  . The inverse text indicates the actual settings.
7. Press  to change the **PROBE A** setting.
8. Select **Probe Type: ■ Voltage | Attenuation: ■ 1:1** .
9. Press 
10. Press  to select **READINGS ON**
11. Press  **READING 1** , and select **■ on A | ■ V dc**
12. Press  **READING 2** , and select **■ on B | ■ V dc**
13. Press  **WAVEFORM OPTIONS** and select  
**Glitch Detect: ■ Off | Average: ■ Off | Waveform: ■ NORMAL**
14. Press  to select MANUAL ranging (**MANUAL** in upper left of screen)
15. Press 
16. Press  **SAVE...**
17. Using  and  select **SCREEN+SETUP □ 1** (or **■ 1**).
18. Press  **SAVE** to save the actual test tool settings in setup memory 1.
19. Press  to leave the HOLD mode.

### 4.5 Display and Backlight Test

Proceed as follows to test the display and the backlight:

1. Press  to turn the test tool on.
2. Remove the BC190 adapter power, and verify that the backlight is dimmed.
3. Apply the BC190 adapter power and verify that the backlight brightness increases.
4. Press and hold  (USER), then press and release  (CLEAR MENU)

The test tool shows the calibration menu in the bottom of the display.

- Do not press **F3** now! If you did, turn the test tool off and on, and start at 4.
  - Pressing **CLEAR MENU** will toggle the menu on-off.
5. Press **F1 PREVIOUS** three times.  
The test tool shows **Contrast (CL 0100)**:
  6. Press **F3 CALIBRATE**. The test tool shows a dark display; the test pattern as shown in Figure 4-2 may be not visible or hardly visible.  
Observe the display closely, and verify that the display shows no abnormalities, as for example very light pixels or lines.

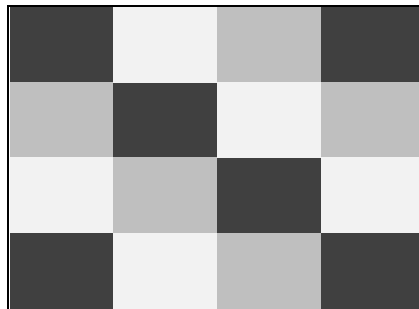

Figure 4-2. Display Test Pattern

7. Press **F2**.  
The test pattern is removed; the test tool shows **Contrast (CL 0100)**:
8. Press **F2** again to do the next step **Contrast (CL 0110)**:
9. Press **F3 CALIBRATE**  
The test tool shows the display test pattern shown in Figure 4-2, at default contrast. Observe the display closely, and verify that the display shows no abnormalities. Also verify that the contrast of the upper left and upper right square of the test pattern is equal.
10. Press **F2**.  
The test pattern is removed; the test tool shows **Contrast (CL 0110)**:
11. Press **F2** again to do the next step **Contrast (CL 0120)**:
12. Press **F3 CALIBRATE**  
The test tool shows a light display; the test pattern as shown in Figure 4-2 may not be visible or hardly visible.  
Observe the display closely, and verify that the display shows no abnormalities.
13. Turn the test tool OFF and ON to exit the calibration menu and to return to the normal operating mode.

If the maximum, minimum, or default display contrast is not OK, then you can set these items without performing a complete calibration adjustment; refer to Section 5 for detailed information.

## 4.6 Scope Input A&B Tests

### 4.6.1 Input A&B Vertical Accuracy Test

#### WARNING

Dangerous voltages will be present on the calibration source and connecting cables during the following steps. Ensure that the calibrator is in standby mode before making any connection between the calibrator and the test tool.

Proceed as follows:

1. Connect the test tool to the 5500A as shown in Figure 4-3.

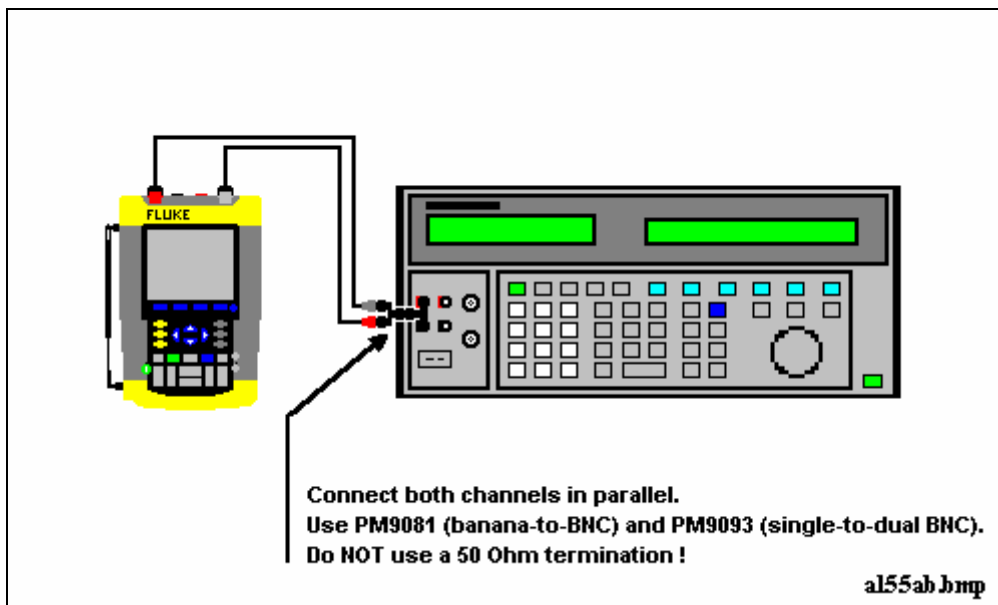

Figure 4-3. Test Tool Input A&B to 5500 Normal Output









al55ab.bmp

2. Select the following test tool setup:
  - Recall the created SETUP 1 (see section 4.4.3): press **SAVE PRINT**, **F2** **RECALL**, select **SCREEN+SETUP** **1**, press **F2** **RECALL SETUP**.
  - Press **A**, press **F4** **INPUT A OPTIONS...**, and select **■ Polarity Normal | Bandwidth: ■ 10 kHz (HF reject)**
  - Press **B**, press **F4** **INPUT B OPTIONS...**, and select **■ Polarity Normal | Bandwidth: ■ 10 kHz (HF reject)**
  - Press **CLEAR MENU** to clear the softkey menu, and to see the full screen.

*Note:*

*The 10 kHz bandwidth limiter rejects calibrator noise. It does not affect the gain accuracy at a 50 Hz input signal*

3. Using **S TIME IN** change the time base to select manual time base ranging, and lock the time base on 10 ms/div.

4. Using  and  move the Input A ground level (indicated by the zero icon  in the left margin) to the center grid line.
5. Using  and  move the Input B ground level (indicated by the zero icon  in the left margin) to the grid line one division below the center grid line.
6. Using  and  set the Input A and B sensitivity range to the first test point in Table 4-1.
7. Set the 5500A to source the appropriate initial ac voltage.
8. Adjust the 5500A output voltage until the displayed Input A trace amplitude is 6 divisions.
9. Observe the 5500A output voltage and check to see if it is within the range shown under the appropriate column.
10. Adjust the 5500A output voltage until the displayed Input B trace amplitude is 6 divisions.
11. Observe the 5500A output voltage and check to see if it is within the range shown under the appropriate column.
12. Continue through the test points.
13. When you are finished, set the 5500A to 0 (zero) Volt, and to Standby.

**Table 4-1. Vertical Accuracy Verification Points**

Range	Initial 5500A Setting, V ac, sine, 50 Hz	Allowable 5500A output for trace amplitude of 6 divisions
2 mV/div <sup>1)</sup>	4.243 mV	4.081 to 4.405
5 mV/div	10.606 mV	10.247 to 10.966
10 mV/div	21.213 mV	20.495 to 21.932
20 mV/div	42.426 mV	40.990 to 43.862
50 mV/div	106.06 mV	102.475 to 109.657
100 mV/div	212.13 mV	204.950 to 219.314
200 mV/div	424.26 mV	409.90 to 438.62
500 mV/div	1.0607 V	1.02475 to 1.09657
1 V/div	2.1213 V	2.04950 to 2.19314
2 V/div	4.2426 V	4.0990 to 4.3862
5 V/div	10.606 V	10.2475 to 10.9657
10 V/div	21.213 V	20.4950 to 21.9314
20 V/div	42.426 V	40.990 to 43.862
50 V/div	106.06 V	102.47 to 109.65
100 V/div	212.13 V	204.95 to 219.31

<sup>1)</sup> C versions only

*Note*

The vertical accuracy test can also be done with dc voltage. This method is advised for automatic verification using the Fluke Met/Cal Metrology Software. For each sensitivity range you must proceed as follows:





















1. Apply a +3 divisions voltage, and adjust the voltage until the trace is at +3 divisions. Write down the applied voltage V1
2. Apply a -3 divisions voltage, and adjust the voltage until the trace is at -3 divisions. Write down the applied voltage V2
3. Verify that  $V1 - V2 = 6 \times \text{range} \pm (1.5\% + 0.04 \times \text{range})$ .:  
Example for range 10 mV/div. (range/div figure doubles because 2 measurements V1 and V2 are done for one accuracy check):  
The allowed  $V1 - V2 = 60 \text{ mV} \pm (0.015 \times 60 + 0.08 \times 10)$   
 $= 60 \text{ mV} \pm (0.9 + 0.8) = 60 \text{ mV} \pm 1.7 \text{ mV}$

### 4.6.2 Input A&B DC Voltage Accuracy Test

#### WARNING

**Dangerous voltages will be present on the calibration source and connecting cables during the following steps. Ensure that the calibrator is in standby mode before making any connection between the calibrator and the test tool.**

Proceed as follows to verify the automatic dc voltage scope measurement:

1. Connect the test tool to the 5500A as for the previous test (see Figure 4-3).
2. Select the following test tool setup:
  - Recall the created SETUP 1 (see section 4.4.3): press ,  **RECALL** , select **SCREEN+SETUP**  **1** , press  **RECALL SETUP** .
  - Press  , then press  **INPUT A OPTIONS ...**
  - Select **Polarity:**  **Normal** | **Bandwidth:**  **10 kHz (HF Reject)**
  - Press  , then press  **INPUT B OPTIONS ...**
  - Select **Polarity:**  **Normal** | **Bandwidth:**  **10 kHz (HF Reject)**
  - Press  to clear the softkey menu, and to see the full 8 divisions screen.
3. Using  **TIME**  change the time base to select manual time base ranging, and lock the time base on 10 ms/div.
4. Using  and  move the Input A and B ground level (zero icon  in the left margin) approximately to the center grid line.
5. Using  and  select manual vertical ranging and set the Input A and B sensitivity range to the first test point in Table 4-2.  
The sensitivity ranges are indicated in the left and right lower display edge.
6. Set the 5500A to source the appropriate dc voltage.
7. Observe the readings (**1.A** and **2.B**) and check to see if it is within the range shown under the appropriate column.  
Due to calibrator noise, occasionally OL (overload) can be shown.
8. Continue through the test points.
9. When you are finished, set the 5500A to 0 (zero) Volt, and to Standby.

**Table 4-2. Volts DC Measurement Verification Points**

Range	5500A output V dc	Input A&B Reading
2 mV/div <sup>1)</sup>	+6.0 mV	+4.9 to +7.1
	-6.0 mV	-4.9 to -7.1
5 mV/div	+15.0 mV	+14.3 to +15.7
	-15.0 mV	-14.3 to -15.7
10 mV/div	+30.0 mV	+29.1 to +30.9
	-30.0 mV	-29.1 to -30.9
20 mV/div	+60.0 mV	+58.6 to +61.4
	-60.0 mV	-58.6 to -61.4
50 mV/div	+150 mV	+143 to +157
	-150 mV	-143 to -157
100 mV/div	+300 mV	+291 to +309
	-300 mV	-291 to -309
200 mV/div	+600 mV	+586 to +614
	-600 mV	-586 to -614
500 mV/div	+1.50 V	+1.43 to +1.57
	-1.50 V	-1.43 to -1.57
1 V/div	+3.00 V	+2.91 to +3.09
	-3.00 V	-2.91 to -3.09
2 V/div	+6.00 V	+5.86 to +6.14
	-6.00 V	-5.86 to -6.14
5 V/div	+15.0 V	+14.3 to +15.7
	-15.0 V	-14.3 to -15.7
10 V/div	+30.0 V	+29.1 to +30.9
	-30.0 V	-29.1 to -30.9
20 V/div	+60.0 V	+58.6 to +61.4
	-60.0 V	-58.6 to -61.4
50 V/div	+150 V	+143 to +157
	-150 V	-143 to -157
100 V/div	+300 V	+291 to +309
	-300 V	-291 to -309

<sup>1)</sup> C versions only.

### 4.6.3 Input A&B AC Voltage Accuracy Test (LF)

This procedure tests the Volts ac accuracy with dc coupled inputs up to 50 kHz. The high frequencies are tested in sections 4.6.10 and 4.6.12.

#### Warning

**Dangerous voltages will be present on the calibration source and connecting cables during the following steps. Ensure that the calibrator is in standby mode before making any connection between the calibrator and the test tool.**

Proceed as follows to test the Input A and B automatic scope ac Voltage measurement accuracy:



























1. Connect the test tool to the 5500A as for the previous test (see Figure 4-3).
2. Select the following test tool setup:
  - Recall the created SETUP 1 (see section 4.4.3): press ,  **RECALL**, select **SCREEN+SETUP** , press  **RECALL SETUP**.
  - Press , then press  **INPUT A OPTIONS ...**
  - Select **Polarity:  Normal | Bandwidth:  20 MHz**
  - Press , then press  **INPUT B OPTIONS ...**
  - Select **Polarity:  Normal | Bandwidth:  20 MHz**
  - Press 
  - Press  **READING 1**, and select ** on A |  V ac.**
  - Press  **READING 2**, and select ** on B |  V ac.**
  - Press  to clear the softkey menu, and to see the full screen.
3. Using  **TIME**  change the time base to select manual time base ranging. Lock the time base on 20  $\mu$ s/div for the 20 kHz signals, and on 10 ms/div for the 60 Hz signal.
4. Using  and  move the Input A and B ground level (indicated by the zero icon  in the left margin) to the center grid line.
5. Using  and  select manual vertical ranging, and set the Input A and B sensitivity range to the first test point in Table 4-3. The sensitivity ranges are indicated in the left and right lower display edge in gray.
6. Set the 5500A to source the appropriate ac voltage.
7. Observe the readings (**1.A** and **2.B**) and check to see if it is within the range shown under the appropriate column.
8. Continue through the test points.
9. When you are finished, set the 5500A to 0 (zero) Volt, and to Standby.















Table 4-3. Volts AC Measurement Verification Points







Range	5500A output		Input A&B Reading
	V ac	Frequency	
2 mV/div <sup>1)</sup> (Select 10 ms/div) Set input A&B Bandwidth 10 kHz to prevent OL due to calibrator noise: see step 2.	4 mV	60 Hz	3.0 mV to 5.0 mV
5 mV/div (Select 20 μs/div). Set input A&B Bandwidth 20 MHz	10 mV	20 kHz	8.3 mV to 11.7 mV
10 mV/div	20 mV	20 kHz	18.0 mV to 22.0 mV
20 mV/div	40 mV	20 kHz	37.5 mV to 42.5 mV
50 mV/div	100 mV	20 kHz	96.0 mV to 104.0 mV
100 mV/div	200 mV	20 kHz	180 mV to 220 mV
200 mV/div	400 mV	20 kHz	375 mV to 425 mV
500 mV/div (Select 10 ms/div)	900 mV	60 Hz	877 mV to 923 mV
500 mV/div (Select 20 μs/div)	900 mV	20 kHz	863 mV to 937 mV
1 V/div	2 V	20 kHz	1.80 V to 2.20 V
2 V/div	4 V	20 kHz	3.75 V to 4.25 V
5 V/div	9 V	20 kHz	8.63 V to 9.37 V
10 V/div	20 V	20 kHz	18.0 V to 22.0 V
20 V/div	40 V	20 kHz	37.5 V to 42.5 V
50 V/div	90 V	20 kHz	86.3 V to 93.7 V
100 V/div	200 V	20 kHz	180 V to 220 V

<sup>1)</sup> C versions only

#### 4.6.4 Input A & B AC Coupled Lower Frequency Test

Proceed as follows to test the ac coupled input low frequency accuracy:

1. Connect the test tool to the 5500A as for the previous test (see Figure 4-3).
2. Select the following test tool setup:
  - Recall the created SETUP 1 (see section 4.4.3): press ,  **RECALL**, select **SCREEN+SETUP**  **1**, press  **RECALL SETUP**.
  - Press 
  - Press  **READING 1**, and select  **on A** |  **V ac**.
  - Press  **READING 2**, and select  **on B** |  **V ac**.
  - Press , then using  select **COUPLING AC**
  - Press , then using  select **COUPLING AC**

- Press  to clear the softkey menu, and to see the full screen.
3. Using  change the time base to select manual time base ranging, and lock the time base on 50 ms/div.
  4. Using  and  move the Input A and B ground level (indicated by the zero icon  in the left margin) to the center grid line.
  5. Using  and  select manual vertical ranging, and set the Input A and B sensitivity range to 500 mV.
  6. Set the 5500A to source the appropriate ac voltage and frequency, according to Table 4-4.
  7. Observe the readings (**1.A** and **2.B**) and check to see if it is within the range shown under the appropriate column.
  8. Continue through the test points.
  9. When you are finished, set the 5500A to 0 (zero) Volt, and to Standby.

**Table 4-4. Input A&B AC Input Coupling Verification Points**















5500A output, V rms	5500A Frequency	Reading 1.A and 1.B
900 mV	60 Hz	873 mV to 927 mV
900 mV	5 Hz	>630 mV

#### 4.6.5 Input A and B Peak Measurements Test

### WARNING

**Dangerous voltages will be present on the calibration source and connecting cables during the following steps. Ensure that the calibrator is in standby mode before making any connection between the calibrator and the test tool.**

Proceed as follows to test the Peak measurement accuracy:

1. Connect the test tool to the 5500A as for the previous test (see Figure 4-3).
2. Select the following test tool setup:
  - Recall the created SETUP 1 (see section 4.4.3): press ,  **RECALL**, select **SCREEN+SETUP** , press  **RECALL SETUP**.
  - Press 
  - Press  **READING 1**, and select  **on A** |  **Peak**. Select  **Peak-Peak** from the **Peak** menu.
  - Press  **READING 2**, and select  **on B** |  **Peak**. Select  **Peak-Peak** from the **Peak** menu.
  - Press  to clear the softkey menu, and to see the full screen.
3. Using  change the time base to select manual time base ranging, and lock the time base on 1 ms/div.





4. Using  and  move the Input A and B ground level (indicated by the zero icon  in the left margin) to the center grid line.
5. Using  and  select manual vertical ranging, and set the Input A and B sensitivity range to 100 mV.
6. Set the 5500A to source the appropriate ac voltage and frequency, according to Table 4-5.
7. Observe the readings (**1.A** and **2.B**) and check to see if it is within the range shown under the appropriate column.
8. Continue through the test points.
9. When you are finished, set the 5500A to 0 (zero) Volt, and to Standby.

Table 4-5. Volts Peak Measurement Verification Points

5500A output, Vrms (sine)	5500A Frequency	Reading A-B
212.13 mV (0.6 V pp)	1 kHz	0.56 to 0.64

#### 4.6.6 Input A&B Frequency Measurement Accuracy Test

Proceed as follows to test the frequency measurement accuracy:

1. Connect the test tool to the 5500A as shown in Figure 4-4. Do NOT use 50 Ω terminations!

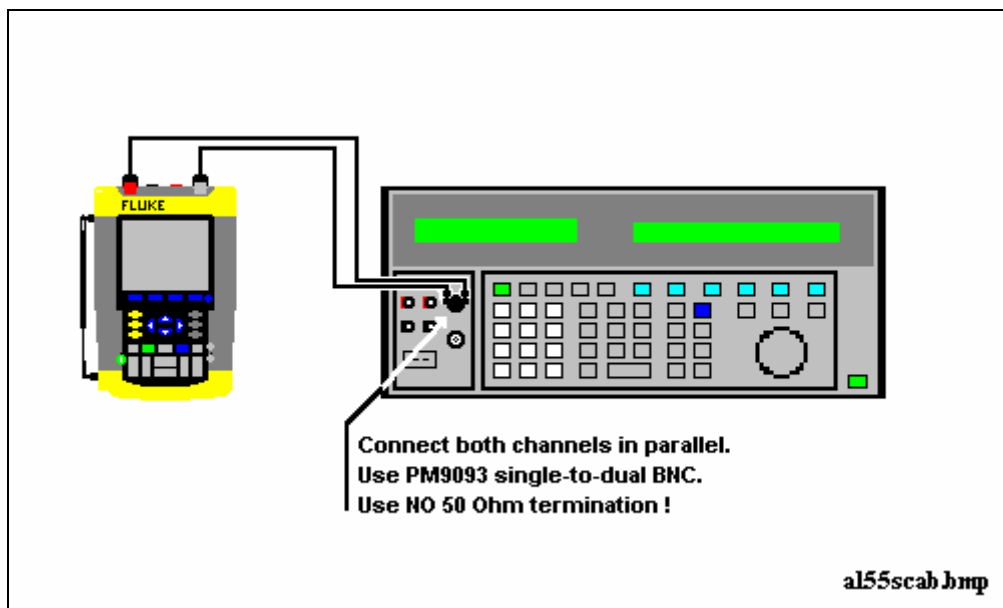







Figure 4-4. 5500 Scope Output to Test Tool Input A&B

2. Select the following test tool setup:
  - Recall the created SETUP 1 (see section 4.4.3): press ,  **RECALL**, select **SCREEN+SETUP**  **1**, press  **RECALL SETUP**.
  - Press 

- Press **F2** **READING 1** , and select **on A | Hz**.
  - Press **F3** **READING 2** , and select **on B | Hz**.
3. Using **RANGE V** and **mV RANGE** select range 100 mV/div for A and B.
  4. Using **S TIME ns** select the required time base setting.
  5. Set the 5500A to source a sine wave according to the first test point in Table 4-6. As no 50Ω termination is applied, the 5500 leveled sine wave output amplitude will be twice the set value.
  6. Observe the readings (**1.A** and **2.B**) and check to see if it is within the range shown under the appropriate column.
  7. Continue through the test points.
  8. When you are finished, set the 5500A to 0 (zero) Volt, and to Standby.

**Table 4-6. Input A&B Frequency Measurement Accuracy Test**

Model	Time base	5500A-SC... MODE	Voltage	Frequency	Input A&B Reading
all	20 ms/div	wavegen, sine	600 mVpp	16 Hz	15.90 to 16.10
192B-C	20 ns/div	levsine	300 mVpp	60 MHz	59.68 to 60.32
196B-C, 215C	20 ns/div	levsine	300 mVpp	100 MHz	99.3 to 100.7
199B-C, 225C	20 ns/div	levsine	300 mVpp	200 MHz	198.8 to 201.2

*Note*

*Duty Cycle and Pulse Width measurements are based on the same principles as Frequency measurements. Therefore the Duty Cycle and Pulse Width measurement function will not be verified separately.*

#### 4.6.7 Input A&B Phase Measurements Test

Proceed as follows to test the phase measurement accuracy:

1. Connect the test tool to the 5500A as for the previous test (see Figure 4-4).
2. Select the following test tool setup:
  - Recall the created SETUP 1 (see section 4.4.3): press **SAVE PRINT** , **F2** **RECALL** , select **SCREEN+SETUP** **1** , press **F2** **RECALL SETUP** .
  - Press **SCOPE**
  - Press **F2** **READING 1** , and select **on A | Phase**.
  - Press **F3** **READING 2** , and select **on B | Phase**.
3. Using **RANGE V** and **mV RANGE** select range 100 mV/div for A and B.
4. Using **S TIME ns** select the required time base setting.
5. Set the 5500A to source a sine wave according to the first test point in Table 4-6. As no 50Ω termination is applied, the 5500 leveled sine wave output amplitude will be twice the set value.

6. Observe the reading **1.A** and **2.B** and check to see if they are not outside the range shown under the appropriate column.
7. Continue through the test points.
8. When you are finished, set the 5500A to 0 (zero) Volt, and to Standby.

**Table 4-7. Phase Measurement Verification Points**

Time base	5500A-SC... MODE	Frequency	Voltage	Input A&B Reading ...Deg
20 ms/div	wavegen, sine, 1 M $\Omega$	10 Hz	600 mVpp	-2 to +2
200 ns/div	levsine	1 MHz	300 mVpp	-2 to +2
20 ns/div	levsine	10 MHz	300 mVpp	-3 to +3

#### 4.6.8 Time Base Test

Proceed as follows to test the time base accuracy:

1. Connect the test tool to the 5500A as shown in Figure 4-5.

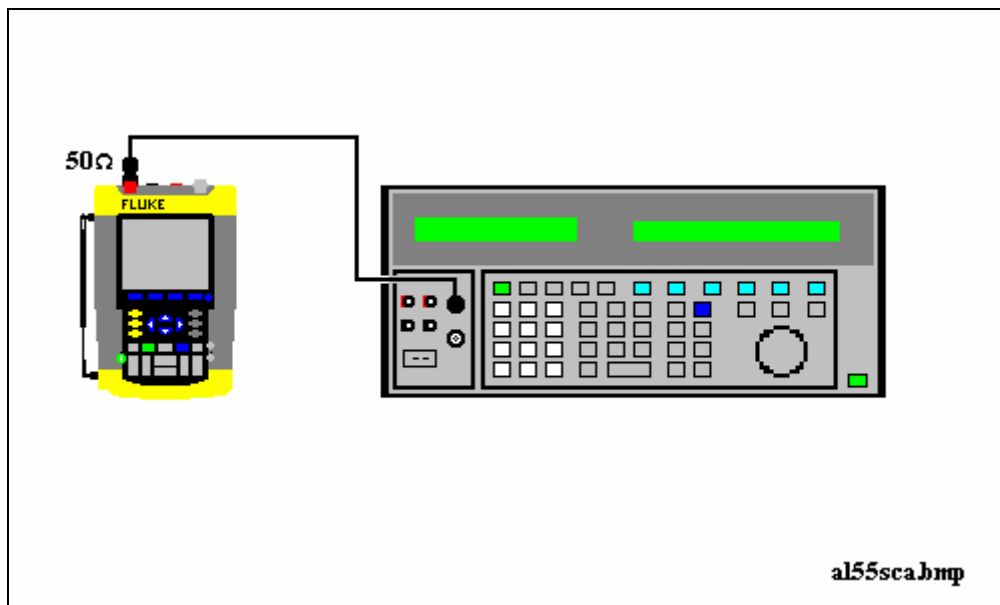







**Figure 4-5. 5500A Scope Output to Test Tool Input A**

al55sca.bmp

2. Set the 5500A to source a 8 ms time marker (MODE marker).
3. Select the following test tool setup:
  - Reset the test tool
  - Using **mV RANGE** and **RANGE V** select manual vertical ranging, and set the Input A sensitivity range to 5V (probe A is 10:1, so input sensitivity is 500 mV/div).
  - Using **S TIME ns** change the time base to select manual time base ranging, and lock the time base on 10 ms/div).
  - Using **MOVE** move the trace to the left. After moving the trace 2 divisions, the trigger delay time with respect to the first vertical grid line will be indicated in

the center of the display bottom.

Adjust the trigger delay time to 8.000 ms (A ⌈ → | 8.00 ms )

- Using  set the time base on 10  $\mu$ s/div.
4. Using  move the trace to the right until the indicated trigger delay is 7.990 ms.
  5. Examine the rising edge of the time marker pulse at the height of the trigger level indicator top. Verify that the rising edge is at the second grid line from the left. The allowed deviation is  $\pm 3$  pixels, see Figure 4-6.
  6. Select the following test tool setup:
    - Using  change the time base to select manual time base ranging, and lock the time base on 10 ms/div).
    - Using  move the trace to adjust the trigger delay time to 800.0  $\mu$ s (A ⌈ 800.0  $\mu$ s).
    - Using  set the time base on 1  $\mu$ s/div.
  7. Set the 5500A to source a 0.8 ms time marker (MODE marker).
  8. Using  move the trace to the right until the indicated trigger delay is 799.0  $\mu$ s.
  9. Examine the rising edge of the time marker pulse at the vertical height of the trigger level indicator top. Verify that the rising edge is at the second grid line from the left. The allowed deviation is  $\pm 3$  pixels, see Figure 4-6.

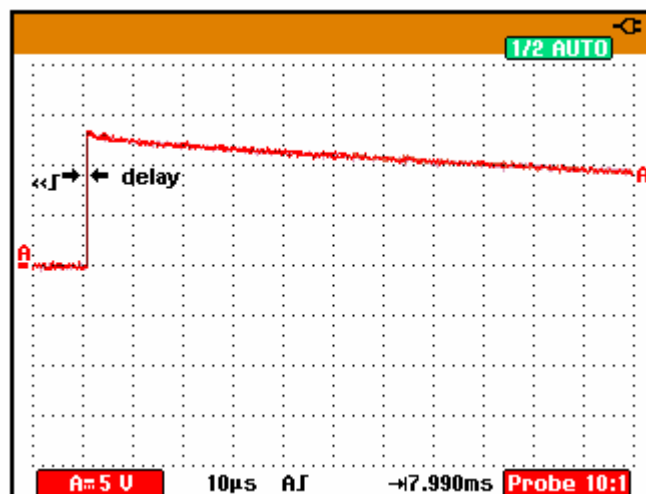







Figure 4-6. Time Base Verification

190c-tb1.bmp

#### 4.6.9 Input A Trigger Sensitivity Test

Proceed as follows to test the Input A trigger sensitivity:

1. Connect the test tool to the 5500A as for the previous test (see Figure 4-5).
2. Select the following test tool setup:
  - Reset the test tool









- Using  and  change the sensitivity range to select manual sensitivity ranging, and lock the Input A sensitivity range on 2 V/div.
3. Using  select the time base indicated under the second column of Table 4-8.
  4. Set the 5500A to source the leveled sine wave for the appropriate test tool model.
  5. Adjust the 5500A output voltage until the displayed trace has the trigger amplitude indicated under the last column of Table 4-8.
  6. Verify that the signal is well triggered.  
If it is not, press , then using  enable the up/down arrow keys for manual Trigger Level adjustment. Adjust the trigger level and verify that the signal will be triggered now. The trigger level is indicated by the trigger icon (⌚).
  7. Continue through the test points.
  8. When you are finished, set the 5500A to Standby.

**Table 4-8. Input A Trigger Sensitivity Test Points**

UUT Model	UUT Time base	5500A SC... MODE levsin		UUT Trigger Amplitude
		Initial Input Voltage	Frequency	
ALL	200 ns/div	100 mV pp	5 MHz	0.5 div
192B-C	10 ns/div	400 mV pp	60 MHz	1 div
	10 ns/div	800 mV pp	100 MHz	2 div
196B-C, 215C	10 ns/div	400 mV pp	100 MHz	1 div
	10 ns/div	800 mV pp	150 MHz	2 div
199B-C, 225C	10 ns/div	400 mV pp	200 MHz	1 div
	10 ns/div	800 mV pp	250 MHz	2 div

### 4.6.10 Input A AC Voltage Accuracy (HF) & Bandwidth Test

Proceed as follows to test the Input A high frequency automatic scope ac voltage measurement accuracy, and the bandwidth:

1. Connect the test tool to the 5500A as for the previous test (see Figure 4-5).
2. Select the following test tool setup:
  - Recall the created SETUP 1 (see section 4.4.3): press ,  **RECALL**, select **SCREEN+SETUP ■ 1**, press  **RECALL SETUP**.
  - Press , then press  **READING 1**, and select **■ on A | ■ V ac**.
  - Press  to select autoranging (**AUTO** in upper right LCD edge)
  - Using  and  change the sensitivity range to select manual sensitivity ranging, and lock the Input A sensitivity range on 500 mV/div. (**AUTO** in upper right LCD edge disappears)
3. Set the 5500A to source a sine wave, to the first test point in Table 4-9.
4. Observe the Input A reading and check to see if it is within the range shown under the appropriate column.
5. Continue through the test points.
6. When you are finished, set the 5500A to Standby.

**Table 4-9. HF AC Voltage Verification Points**

UUT Model	5500A SC... MODE levsin		UUT Reading A
	Voltage	Frequency	
all	2.545 Vpp	1 MHz	835 mV to 965 mV
all	2.545 Vpp	25 MHz	790 mV to 1.010 V
192B-C	2.545 Vpp	60 MHz	>630 mV
196B-C, 215C	2.545 Vpp	100 MHz	>630 mV
199B-C, 225C	2.545 Vpp	200 MHz	>630 mV

#### 4.6.11 Input B Trigger Sensitivity Test

Proceed as follows to test the Input B trigger sensitivity:

1. Connect the test tool to the 5500A as shown in Figure 4-7.

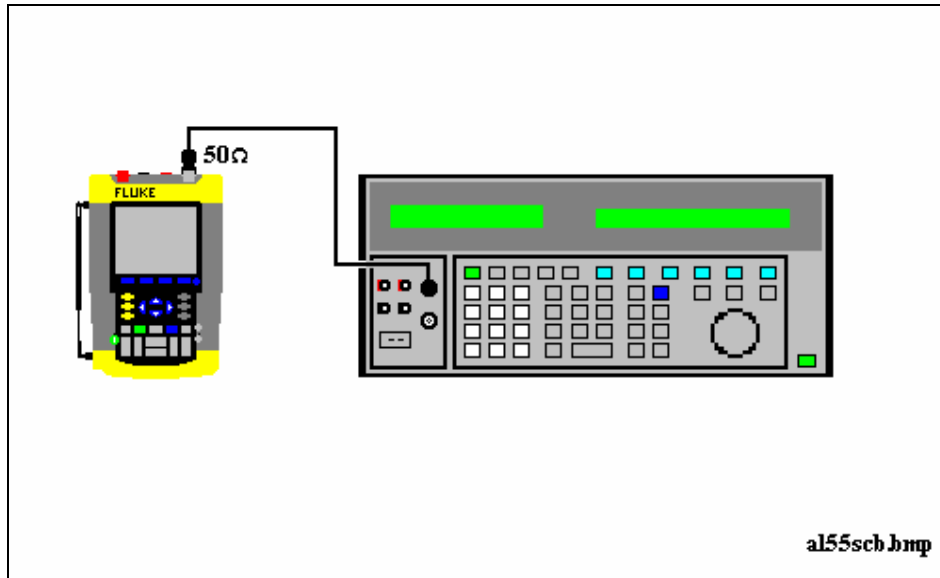

Figure 4-7. 5500A Scope Output to Test Tool Input B

al55sch.bmp

2. Select the following test tool setup:
  - Reset the test tool
  - Press **B** and use **F1** to turn Input B on.
  - Press **A** and use **F1** to turn Input A off.
  - Using **MOVE** move the Input B trace zero to the center grid line.
  - Press **TRIGGER** and use **F1** to select Input B as trigger source.
  - Using **RANGE V** and **mV RANGE** change the sensitivity range to select manual sensitivity ranging, and lock the Input B sensitivity range on 2 V/div.
3. Using **S TIME ns** select the time base indicated under the first column of Table 4-10.
4. Set the 5500A to source the leveled sine wave given in the first row of Table 4-10.
5. Adjust the 5500A output voltage until the displayed trace has the amplitude indicated under the appropriate column of Table 4-10.
6. Verify that the signal is well triggered.  
If it is not, press **TRIGGER**, then using **F3** enable the up/down arrow keys for manual Trigger Level adjustment. Adjust the trigger level and verify that the signal will be triggered now. The trigger level is indicated by the trigger icon (□).
7. Continue through the test points.
8. When you are finished, set the 5500A to Standby.

Table 4-10. Input B Trigger Sensitivity Test Points

UUT Model	UUT Time base	5500A SC... MODE levsin		UUT Trigger Amplitude
		Initial Input Voltage	Frequency	
ALL	200 ns/div	100 mV pp	5 MHz	0.5 div
192B-C	10 ns/div	400 mV pp	60 MHz	1 div
	10 ns/div	800 mV pp	100 MHz	2 div
196B-C, 215C	10 ns/div	400 mV pp	100 MHz	1 div
	10 ns/div	800 mV pp	150 MHz	2 div
199B-C, 225C	10 ns/div	400 mV pp	200 MHz	1 div
	10 ns/div	800 mV pp	250 MHz	2 div

#### 4.6.12 Input B AC Voltage Accuracy (HF) & Bandwidth Test

Proceed as follows to test the Input B high frequency automatic scope ac voltage measurement accuracy, and the bandwidth:









1. Connect the test tool to the 5500A as for the previous test (see Figure 4-7).
2. Select the following test tool setup:
  - Recall the created SETUP 1 (see section 4.4.3): press ,  **RECALL** , select **SCREEN+SETUP** , press  **RECALL SETUP** .
  - Press , then press  **READING 2** , and select **on B | V ac**.
  - Press  to select autoranging (**AUTO** in upper right LCD edge)
  - Using  and  change the sensitivity range to select manual sensitivity ranging, and lock the Input B sensitivity range on 500 mV/div.
3. Set the 5500A to source a sine wave, to the first test point in Table 4-11.
4. Observe the Input B reading and check to see if it is within the range shown under the appropriate column of table 4-11.
5. Continue through the test points.
6. When you are finished, set the 5500A to Standby.

Table 4-11. HF AC Voltage Verification Points

UUT Model	5500A SC... MODE levsin		UUT Reading B
	Voltage	Frequency	
all	2.545 Vpp	1 MHz	835 mV to 965 mV
all	2.545 Vpp	25 MHz	790 mV to 1.010 V
192B-C	2.545 Vpp	60 MHz	>630 mV
196B-C, 215C	2.545 Vpp	100 MHz	>630 mV
199B-C, 225C	2.545 Vpp	200 MHz	>630 mV

#### 4.6.13 Video test using the Video Pattern Generator

You can skip this test if you do the test **4.6.14 Video test using the SC600 Scope Calibration option**

Only one of the systems NTSC, PAL, PALplus, or SECAM has to be verified.

Proceed as follows:

1. Connect the test tool to the TV Signal Generator as shown in Figure 4-8.

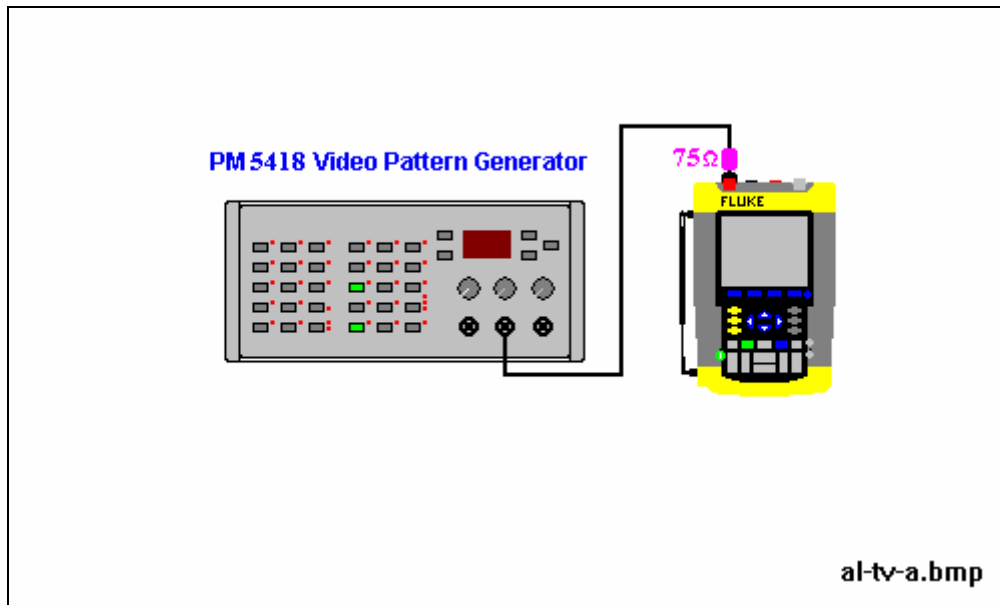

Figure 4-8. Test Tool Input A to TV Signal Generator

al-tv-a.bmp

2. Select the following test tool setup:
  - Reset the test tool
  - Press **TRIGGER**, then press **F4** to open the Trigger Options menu.
  - Choose **VIDEO on A...**, then from the shown opened menu choose **Polarity: POSITIVE | PAL ( or NTSC PALplus SECAM )**
  - Press **F2** to select **ALL LINES**
  - Press **F3** to enable the arrow keys for selecting the video line number.
  - Using **▲ ▼** select line number:
    - ⇒ 622 for PAL, PALplus, or SECAM
    - ⇒ 525 for NTSC.
  - Using **RANGE V** and **mV RANGE** set the Input A sensitivity to 2 V/div (the actual probe setting is 10:1).
  - Using **S TIME NS** select the time base to 20 μs/div.
3. Set the TV Signal Generator to source a signal with the following properties:
  - the system selected in step 2
  - gray scale

- sync pulse amplitude > 0.7 div.
  - chroma amplitude zero.
4. Observe the trace, and check to see if the test tool triggers on line number:
    - ⇒ 622 for PAL or SECAM, see Figure 4-9
    - ⇒ 525 for NTSC, see Figure 4-10.

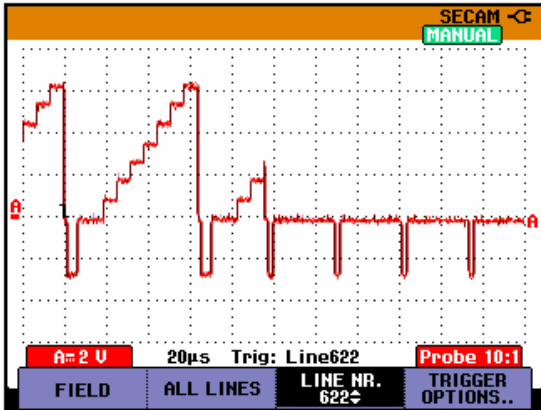

Figure 4-9. Trace for PAL/SECAM line 622

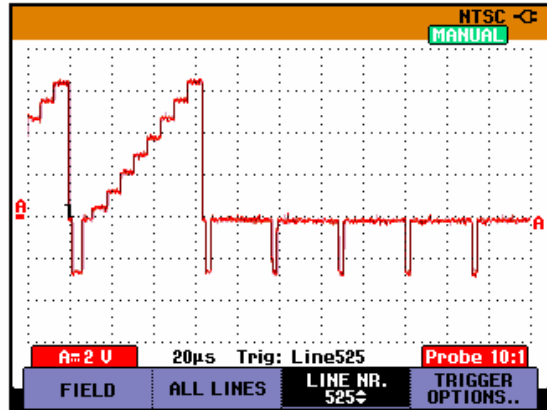

Figure 4-10. Trace for NTSC line 525

5. Using  $\uparrow$   $\downarrow$  select line number:
  - ⇒ 310 for PAL or SECAM
  - ⇒ 262 for NTSC
6. Observe the trace, and check to see if the test tool triggers on:
  - ⇒ line number 310 for PAL or SECAM, see Figure 4-11.
  - ⇒ line number 262 for NTSC, see Figure 4-12.

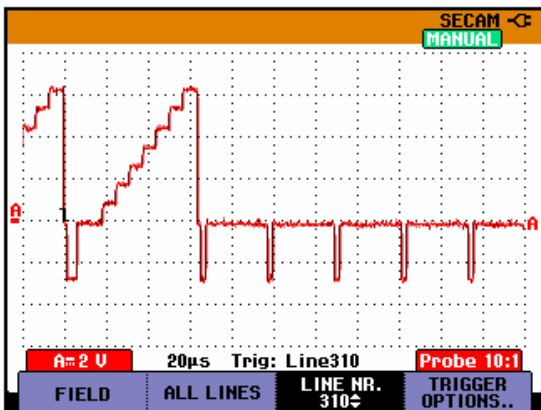

Figure 4-11. Trace for PAL/SECAM line 310

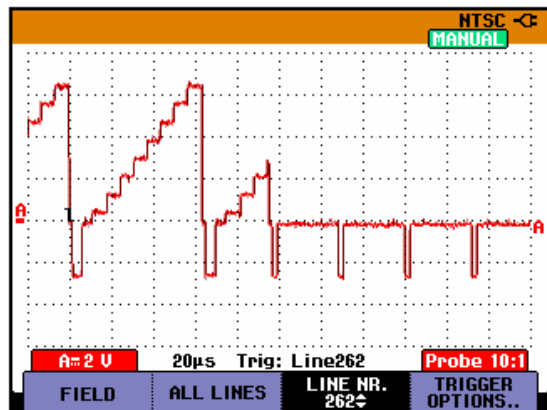

Figure 4-12. Trace for NTSC line 262

7. Apply the inverted TV Signal Generator signal to the test tool.  
Invert the signal by using a Banana Plug to BNC adapter (Fluke PM9081/001) and a Banana Jack to BNC adapter (Fluke PM9082/001), as shown in Figure 4-13.

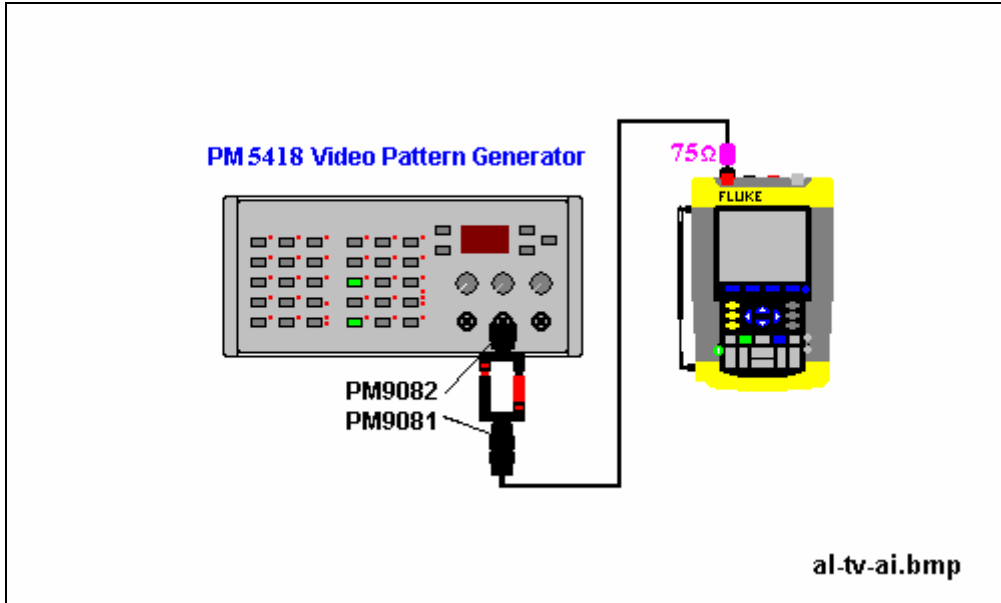

Figure 4-13. Test Tool Input A to TV Signal Generator Inverted

al-tv-ai.bmp

8. Select the following test tool setup:
  - Press **F4** to open the Trigger Options menu.
  - Choose **VIDEO on A...**, then from the shown opened menu choose **Polarity: NEGATIVE | PAL** ( or **NTSC PALplus SECAM** )
9. Using **▲ ▼** select line number 310 (PAL or SECAM) or 262 (NTSC)
10. Observe the trace, and check to see if the test tool triggers on line number 310 (PAL or SECAM, see Figure 4-14), or line number 262 (NTSC, see Figure 4-15).

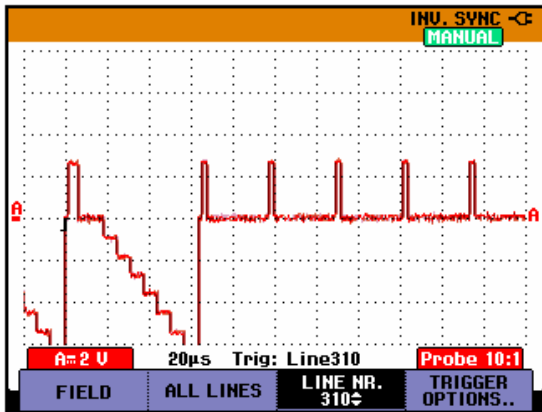

Figure 4-14. Trace for PAL/SECAM line 310 Negative Video

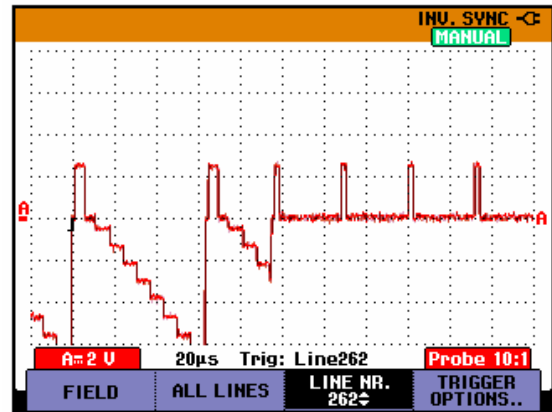

Figure 4-15. Trace for NTSC line 262 Negative Video

#### 4.6.14 Video test using SC600 Scope Calibration Option

You can skip this test if you did test **4.6.13 Video test using the Video Pattern Generator**.

Only one of the systems NTSC, PAL, PALplus, or SECAM has to be verified.

Proceed as follows:

1. Connect the test tool to the calibrator as shown in Figure 4-16.

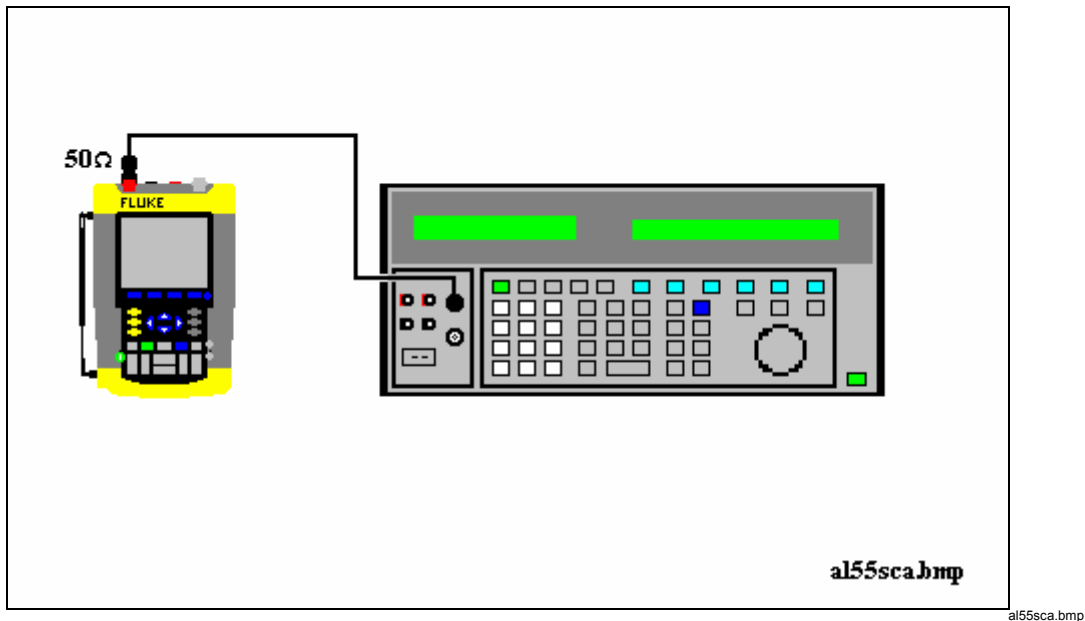







Figure 4-16. Test Tool Input A to TV Signal Generator

2. Select the following test tool setup:
  - Reset the test tool
  - Press **TRIGGER**, then press **F4** to open the Trigger Options menu.
  - Choose **VIDEO on A...**, then from the shown opened menu choose  
**Polarity: POSITIVE | PAL ( or NTSC PALplus SECAM )**
  - Press **F2** to select **ALL LINES**
  - Press **F3** to enable the arrow keys for selecting the video line number.
  - Using **▲ ▼** select line number:  
 ⇒ 622 for PAL, PALplus, or SECAM  
 ⇒ 525 for NTSC.
  - Using **RANGE V** and **RANGE mV** set the Input A sensitivity to 2 V/div (the actual probe setting is 10:1).
  - Using **S TIME ns** select the time base to 20  $\mu$ s/div.
3. Set the calibrator to mode video with amplitude +100%. Set format and marker line number to :
  - ⇒ PAL 622 (even), for PAL and PALplus
  - ⇒ SECAM 622 (even), for SECAM
  - ⇒ NTSC 262 even, for NTSC.
4. Observe the trace, and check to see if the test tool triggers on the negative pulse before the marker pulse (see Figure 17).

5. Using   select test tool line number:
  - ⇒ 310 for PAL, PALplus or SECAM
  - ⇒ 262 for NTSC
6. Set the calibrator format and marker line number to :
  - ⇒ PAL 310 (odd), for PAL and PALplus
  - ⇒ SECAM 310 (odd), for SECAM
  - ⇒ NTSC 262 odd, for NTSC.
7. Observe the trace, and check to see if the test tool triggers on the negative pulse before the marker.
8. Select the following test tool setup:
  - Press  to open the Trigger Options menu.
  - Choose **VIDEO on A...** , then from the shown opened menu choose **Polarity:  NEGATIVE |  PAL ( or  NTSC  PALplus  SECAM )**
9. Set the calibrator video trigger output signal to -100%
10. Using   select line number 310 (PAL, PALplus or SECAM) or 262 (NTSC)
11. Set the calibrator format and marker line number to :
  - ⇒ PAL 310 (odd), for PAL and PALplus
  - ⇒ SECAM 310 (odd), for SECAM
  - ⇒ NTSC 262 odd, for NTSC.
12. Observe the trace, and check to see if the test tool triggers on the positive pulse before the marker.

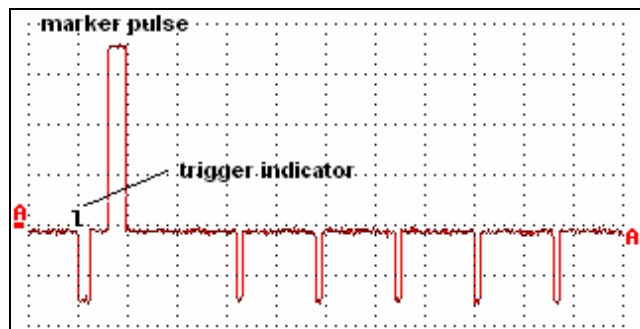

Figure 4-17. SC600 Marker Pulse

video-sc600.bmp

## 4.7 External Trigger Level Test

Proceed as follows:

1. Connect the test tool to the 5500A as shown in Figure 4-18.

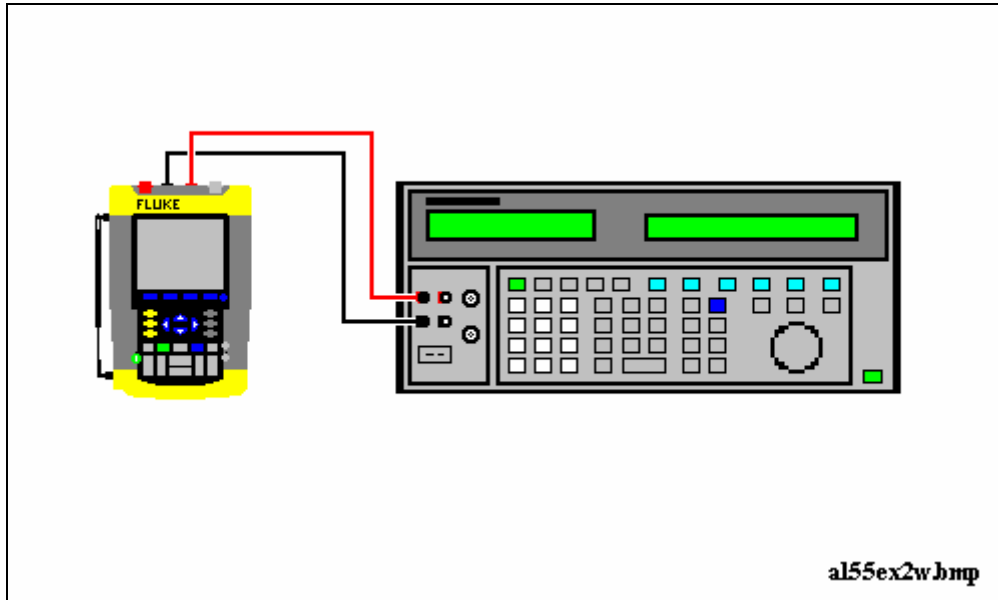

Figure 4-18. Test Tool Meter/Ext Input to 5500A Normal Output

al55ex2w.bmp

2. Select the following test tool setup:
  - Reset the test tool
  - Press **TRIGGER**
  - Using **F4** select the **TRIGGER OPTIONS...** menu
    - ⇒ Select **On Edges...** from the **TRIGGER OPTIONS** menu
    - ⇒ Select **Update: Single Shot | Noise reject Filter: On**
  - Using **F1** **EDGE TRIG** select **Ext** .
  - Using **F2** **SLOPE** select positive slope triggering (trigger icon  $\lrcorner$  ).
  - Using **F3** **Ext LEVEL** select **1.2 V**
3. Set the 5500A to source 0.4V dc.
4. Verify that no trace is shown on the test tool display, and that the status line at the display top shows **SINGLE MANUAL** or **SINGLE WAITING**. If the display shows the trace, and status **SINGLE HOLD** then press **HOLD RUN** to re-arm the test tool for a trigger.
5. Set the 5500A to source 1.7 V
6. Verify that the test tool is triggered by checking that the trace becomes visible. To repeat the test, start at step 3.
7. Set the 5500A to Standby.

## 4.8 Meter (DMM) Tests

### 4.8.1 Meter DC Voltage Accuracy Test

#### WARNING

**Dangerous voltages will be present on the calibration source and connecting cables during the following steps. Ensure that the calibrator is in standby mode before making any connection between the calibrator and the test tool.**

Proceed as follows to test the meter dc voltage measurement accuracy:

1. Connect the test tool to the 5500A as for the previous test (see Figure 4-18).
2. Select the following test tool setup:
  - Press **METER** (this key will toggle the menu bar on and off if the test tool is already in the meter mode)
  - Press **F1** to open the Measurement menu, and select **V dc**
  - Press **F4** to select MANUAL ranging; use **▲ ▼** to select the ranges.
3. Set the range to the first test point in Table 4-12.
4. Set the 5500A to source the appropriate dc voltage.
5. Observe the reading and check to see if it is within the range shown under the appropriate column.
6. Continue through the test points.
7. When you are finished, set the 5500A to 0 (zero) Volt, and to Standby.

**Table 4-12. Meter Volts dc Measurement Verification Points**





Range	5500A output V dc	Meter Reading
500.0 mV	+ 500 mV	497.0 to 503.0
	- 500 mV	-497.0 to -503.0
	0 mV	-0.5 to +0.5
5.000 V	+ 5.000 V	4.970 to 5.030
	- 5.000 V	-4.970 to -5.030
50.00 V	+ 50.00 V	49.70 to 50.30
	- 50.00 V	-49.70 to -50.30
500.0 V	+ 500.0 V	497.0 to 503.0
	- 500.0 V	-497.0 to -503.0
1100 V	+ 1000 V	0.990 to 1.010
	- 1000 V	-0.990 to -1.010

### 4.8.2 Meter AC Voltage Accuracy & Frequency Response Test

#### Warning

**Dangerous voltages will be present on the calibration source and connecting cables during the following steps. Ensure that the calibrator is in standby mode before making any connection between the calibrator and the test tool.**

Proceed as follows to test the ac voltage measurement accuracy:



1. Connect the test tool to the 5500A as for the previous test (see Figure 4-18).
2. Select the following test tool setup:
  - Press 
  - Press  to open the Measurement menu, and select **V ac**
  - Press  to select MANUAL ranging; use   to select the ranges
3. Set the range to the first test point in Table 4-13.
4. Set the 5500A to source the appropriate ac voltage.
5. Observe the reading and check to see if it is within the range shown under the appropriate column.
6. Continue through the test points.
7. When you are finished, set the 5500A to 0 (zero) Volt, and to Standby.

**Table 4-13. Meter Volts AC Measurement Verification Points**

Range	5500A output V ac	Frequency	Meter Reading
500.0 mV	500.0 mV	60 Hz	494.0 to 506.0
		1 kHz	486.0 to 514.0
		10 kHz	>350.0
5.000 V	5.000 V	60 Hz	4.940 to 5.060
		1 kHz	4.860 to 5.140
		10 kHz	>3.500
50.00 V	50.00 V	60 Hz	49.40 to 50.60
		1 kHz	48.60 to 51.40
		10 kHz	>35.00
500.0 V	500.0 V	60 Hz	494.0 to 506.0
		1 kHz	486.0 to 514.0
		10 kHz	>350.0
1100 V (1.1 kV)	1000 V	60 Hz	0.980 to 1.020
		1 kHz	0.960 to 1.040
		10 kHz	> 0.700



### 4.8.3 Continuity Function Test

Proceed as follows:

1. Select the following test tool setup:
  - Press 
  - Press  to open the Measurement menu, and select **■ Continuity**
2. Connect the test tool to the 5500A as for the previous test (see Figure 4-18).
3. Set the 5500A to 20  $\Omega$ . Use the 5500A "COMP OFF" mode.
4. Listen to hear that the beeper is on.
5. Set the 5500A to 80  $\Omega$ .
6. Listen to hear that the beeper is off.
7. When you are finished, set the 5500A to Standby.

### 4.8.4 Diode Test Function Test

Proceed as follows to test the Diode Test function :

1. Select the following test tool setup:
  - Press 
  - Press  to open the Measurement menu, and select **■ Diode**
2. Connect the test tool to the 5500A as for the previous test (see Figure 4-18).
3. Set the 5500A to **1 k $\Omega$** . Use the 5500A "COMP OFF" mode.
4. Observe the main reading and check to see if it is within **0.4 V** and **0.6 V**.
5. Set the 5500A to **1 V dc**.
6. Observe the main reading and check to see if it is within **0.975 V** and **1.025 V**.
7. When you are finished, set the 5500A to Standby.

### 4.8.5 Ohms Measurements Test

Proceed as follows to test the Ohms measurement accuracy:

1. Connect the test tool to the 5500A as shown in Figure 4-19.

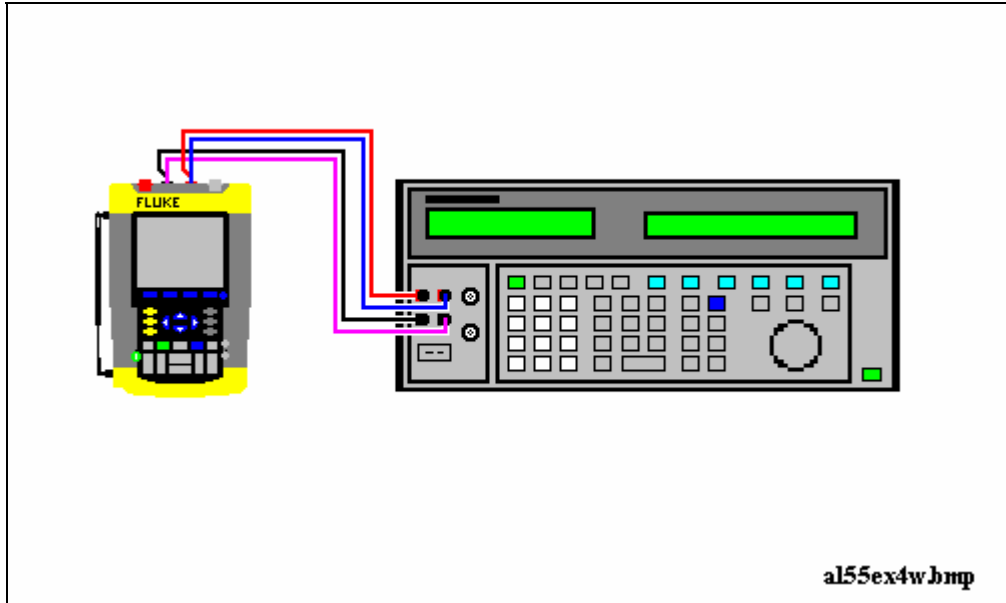

Figure 4-19. Test Meter Tool Input to 5500A Normal Output 4-Wire

al55ex4w.bmp

2. Select the following test tool setup:
  - Press **METER**
  - Press **F1** to open the Measurement menu, and select **Ohms**
  - Press **F3** to select AUTO ranging.
3. Set the 5500A to source the appropriate resistance value for the first test point in Table 4-14.  
Use the 5500A “COMP 2 wire” mode for the verifications up to and including 50 kΩ. For the higher values, the 5500A will turn off the “COMP 2 wire” mode.
4. Observe the reading and check to see if it is within the range shown under the appropriate column.
5. Continue through the test points.
6. When you are finished, set the 5500A to Standby.

Table 4-14. Resistance Measurement Verification Points

5500A output	Meter Reading
0Ω	0.0 to 0.5
400Ω	397.1 to 402.9
4 kΩ	3.971 to 4.029
40 kΩ	39.71 to 40.29
400 kΩ	397.1 to 402.9
4 MΩ	3.971 to 4.029
30 MΩ	29.77 to 30.23

## **4.9 Probe Calibration Generator Test**

To verify the internal probe calibration square wave generator, you can do a Probe Calibration as described in section 5.8. If no square wave appears on the screen, either

- the probe is defective: try another probe, check the probe with an external voltage in a scope application,

or

- the internal square wave generator is defective.

This is the end of the Performance Verification Procedure.

# **Chapter 5**

## **Calibration Adjustment**

<b>Title</b>	<b>Page</b>
5.1 General.....	5-3
5.1.1 Introduction .....	5-3
5.1.2 Calibration number and date.....	5-3
5.1.3 General Instructions.....	5-3
5.1.4 Equipment Required For Calibration .....	5-3
5.2 Calibration Procedure Steps.....	5-4
5.3 Starting the Calibration.....	5-4
5.4 Contrast Calibration Adjustment .....	5-6
5.5 Warming Up & Pre-Calibration.....	5-7
5.6 Final Calibration .....	5-8
5.6.1 Input A LF-HF Gain.....	5-8
5.6.2 Input B LF-HF Gain .....	5-9
5.6.3 Input A&B LF-HF Gain .....	5-11
5.6.4 Input A&B Position.....	5-12
5.6.5 Input A&B Volt Gain .....	5-13
5.6.6 DMM Volt Gain .....	5-14
5.6.7 Input A& B, and DMM Zero.....	5-15
5.6.8 DMM Ohm Gain .....	5-16
5.6.9 Calculate Gain.....	5-17
5.7 Save Calibration Data and Exit.....	5-17
5.8 Probe Calibration .....	5-19

## 5.1 General



### 5.1.1 Introduction

The following information, provides the complete Calibration Adjustment procedure for the ScopeMeter test tool (referred to as test tool). The test tool allows closed-case calibration using known reference sources. It measures the reference signals, calculates the correction factors, and stores the correction factors in RAM. After completing the calibration, the correction factors can be stored in FlashROM.

The test tool should be calibrated after repair, or if it fails the performance test. The test tool has a normal calibration cycle of one year.

### 5.1.2 Calibration number and date

When storing valid calibration data in FlashROM after performing the calibration adjustment procedure, the calibration date is set to the actual test tool date, and calibration number is raised by one. To display the calibration date and - number:

1. Press , then press  to see the Version & Calibration data (see Figure 5.1).
2. Press  to return to exit the Version & Calibration screen.

Version & Calibration	
<b>Model Number :</b>	<b>199C</b>
<b>Software Version:</b>	<b>U05.00</b>
<b>Calibration Number:</b>	<b>#1</b>
<b>Calibration Date:</b>	<b>01/01/2002</b>
<b>Battery Refresh Date:</b>	<b>01/01/2002</b>

wm-verscal.bmp

**Figure 5-1. Version & Calibration Data**

*Note:*

*The calibration date and calibration number will not be changed if only the Contrast Calibration Adjustment and /or the Probe Calibration is done*

### 5.1.3 General Instructions

Follow these general instructions for all-calibration steps:

- Allow the 5500A to satisfy its specified warm-up period. For each calibration point , wait for the 5500A to settle.
- The required warm up period for the test tool is included in the WarmingUp & PreCal calibration step.
- Ensure that the test tool battery is charged sufficiently.
- Power the test tool via the BC190 Battery Charger/Power Adapter

### 5.1.4 Equipment Required For Calibration

The primary source instrument used in the calibration procedures is the Fluke 5500A. If a 5500A is not available, you can substitute another calibrator as long as it meets the minimum test requirements.

- Fluke 5500A Multi Product Calibrator, including SC300 or SC600 Oscilloscope Calibration Option.
- Stackable Test Leads (4x), supplied with the 5500A.
- 50Ω Coax Cable (2x), for example Fluke PM9091 (1.5m) or PM9092 (0.5m).
- 50Ω feed through termination, Fluke PM9585.
- Male BNC to Dual Female BNC Adapter (1x), Fluke PM9093/001.
- Dual Banana Plug to Female BNC Adapter (1x), Fluke PM9081/001.

## **5.2 Calibration Procedure Steps**

To do a **complete** calibration adjustment you must do all following steps:

1. Select the Calibration Mode, section 5.3
2. Do the Contrast Calibration Adjustment, section 5.4
3. Do the WarmingUp & PreCalibration, section 5.5
4. Do the Final Calibration, section 5.6
5. Save the Calibration Data and Exit the calibration mode, section 5.7
6. Do the probe Calibration, section 5.8





**Steps 4 and 5 must always be done together and completely in the order given in this manual. Skipping adjustment steps will make the calibration invalid!**

The following **partial** calibrations are allowed:

- Contrast calibration, do the above-mentioned steps 1, 2, and 5.  
If during normal operation the display cannot be made dark or light enough, or if the display after a test tool reset is too light or too dark, you can do this calibration.
- Probe calibration, do the above-mentioned step 6.  
The probe calibration matches the probe to the used input channel.



## **5.3 Starting the Calibration**

Follow the steps below to start the calibration:

1. Power the test tool via the power adapter input using the BC190 power adapter.
2. Check the actual test tool date, and adjust the date if necessary (the calibration date will become the test tool date when saving the calibration data):
  - Press  (toggles the menu bar on-off)
  - press  to open the **OPTIONS** menu
  - using   select **DATE ADJUST...**
  - press  to open the **DATE ADJUST** menu
  - adjust the date if necessary.
3. Select the calibration mode.

The Calibration Adjustment Procedure uses built-in calibration setups, that can be accessed in the calibration mode.

To enter the calibration mode proceed as follows:

- Press and hold  , press and release  , release 





The display shows the **CAL MODE** (Calibration Adjustment) screen.

The display shows the calibration step **Warming Up (CL 0200)** , the calibration status **:IDLE (valid)** or **:IDLE (invalid)** , and the softkey menu.

Continue as indicated in section 5.2.

You can leave the calibration mode without changing the calibration data by turning the test tool off.

**Explanation of screen messages and key functions.**

When the test tool is in the calibration Mode, only the  to  soft keys, the  key, and the  key can be operated, unless otherwise stated.





The calibration adjustment screen shows the actual calibration step (name and number) and its status: **Cal Name (CL nnnn) :Status (...)**

**Cal Name** Name of the selected calibration step, e.g. **WarmingUp**  
**(CL nnnn)** Number of the calibration step

**Status (...)** can be:

- IDLE (valid)** After (re)entering this step, the calibration process is not started. The calibration data of this step are valid. This means that the last time this step was done, the calibration was successful. It does not necessarily mean that the unit meets the specifications related to this step!
- IDLE (invalid)** After (re)entering this step, the calibration process is not started. The calibration data are invalid. This means that the last time this step was done, the calibration was not successful. Most probably the unit will not meet the specifications if the actual calibration data are saved.
- BUSY aaa% bbb%** Calibration adjustment step in progress; progress % for Input A and Input B. During WarmingUp the elapsed time is shown.
- READY** Calibration adjustment step finished.
- Error :xxxx** Calibration adjustment failed, due to wrong input signal(s) or because the test tool is defective.  
If the error code is <5000 you can repeat the failed step.  
If the error code is ≥5000 you must repeat the complete final calibration (start at 5.6.1).

Functions of the keys F1-F4 are:

-  **PREV** select the previous step
-  **NEXT** select the next step
-  **CAL** start the calibration adjustment of the actual step
-  **EXIT** leave the calibration mode

















## 5.4 Contrast Calibration Adjustment

After entering the calibration mode the display shows:

### WarmingUp (CL 0200):IDLE (valid)

Do not press  now! If you did, turn the test tool off and on, and enter the calibration mode again.

Proceed as follows to adjust the maximum display darkness (CL 0100), the default contrast (CL 0110), and the maximum display brightness (CL 0120).

1. Press  three times to select maximum darkness calibration **Contrast (CL 0100):**
2. Press  **CALIBRATE**. The display will show a dark test pattern, see Figure 5-2
3. Using   adjust the display to the maximum darkness at which the test pattern is only just visible.
4. Press  to return to the softkey menu.
5. Press  to select default contrast calibration **Contrast (CL 0110):**
6. Press  **CALIBRATE**. The display shows the test pattern at default contrast.
7. Using   set the display to optimal (becomes default) contrast.
8. Press  to return to the softkey menu.
9. Press  to select maximum brightness calibration **Contrast (CL 0120):**
10. Press  **CALIBRATE**. The display shows a bright test pattern.
11. Using   adjust the display to the maximum brightness, at which the test pattern is only just visible.
12. Press  to return to the softkey menu.
13. Now you can either
  - Exit, if only the Contrast had to be adjusted. Continue at Section 5.7.**or**
  - Do the complete calibration. Press  to select the next step (WarmingUp), and continue at Section 5.5.

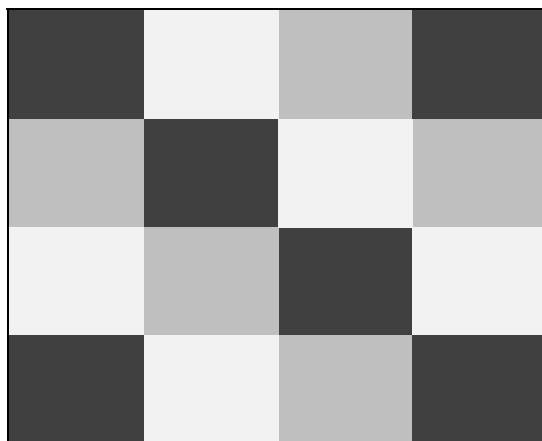

Figure 5-2. Display Test Pattern

## 5.5 Warming Up & Pre-Calibration

The WarmingUp & Pre-Calibration state will be entered after entering the calibration mode (section 5.3), or after selecting the next step if you have done the Contrast Calibration step CL 120 (section 5.4). The display will show **WarmingUp (CL 0200):IDLE (valid)** or **(invalid)**.

Unless you want to calibrate the display contrast only, you must always start the calibration adjustment at the **Warming Up (CL 0200)** step. Starting at another step will make the calibration invalid!

The WarmingUp & Pre-Calibration consists of a 30 minutes warming-up period, and several internal calibration adjustment steps that do not require input signals.

Proceed as follows to do the WarmingUp & Pre-Calibration:

1. Remove all input connections from the test tool.
2. Press **F3** to start the Warming-Up & Pre-Calibration.  
The display shows the calibration step in progress, and its status.  
The first step is **WarmingUp (CL 0200) :BUSY 00:29:59**. The warming-up period is counted down from 00:29:59 to 00:00:00. Then the remaining pre-calibration steps are performed automatically. The entire procedure takes about 60 minutes.
3. Wait until the display shows **End Precal: READY**  
The PreCal data have now been stored in FlashROM.  
If you turn off the test tool now by accident, turn it on again immediately; now you can select the calibration mode, and continue with step 4 below (press **F2 NEXT** several times, see 5.6).  
If you turn off the instrument now, and you do not turn on immediately, the test tool has cooled down, and you must repeat the WarmingUp and PreCalibration (select the calibration mode and start at CL 0200).
4. Press **F2 NEXT** and continue at Section 5.6.

### Error Messages

If error message **1000** is displayed during WarmingUp or PreCalibration step CL0215, the Main PCA hardware version is not suitable for the installed software version. Other error messages during WarmingUp or PreCalibration indicate that the test tool is defective, and should be repaired.

## 5.6 Final Calibration

Before starting the final calibration you must have done the WarmingUp & PreCalibration (section 5.5)!

The final calibration requires input conditions that will be described in each step. After starting a step, several steps that require the same input conditions will be done automatically. So if you start for example calibration step CL 0915, the calibration can include also step CL 0916, and at the end the display then shows CL 0916: READY

You must always start the Final Calibration at the first step, see Section 5.6.1. Starting at another step will make the calibration invalid!

If you proceeded to calibration step N (for example step CL 0620), then return to a previous step (for example step CL 0616) , and then calibrate this step, the complete final calibration becomes invalid; then you must repeat the calibration starting at 5.6.1.

It is allowed to repeat a step that shows the status :READY by pressing  again.

### Error messages

Proceed as follows if an error message **ERROR: nnnn** is displayed during calibration:

- if **nnnn** < 5000 then check input signal and test leads, and repeat the current step by pressing  again.
- if **nnnn** ≥ 5000 then check input signal and test leads, and repeat the final calibration starting at section 5.6.1.

If the error persists the test tool is defective.

### 5.6.1 Input A LF-HF Gain

Proceed as follows to do the Input A LF-HF Gain calibration:

1. Connect the test tool to the 5500A as shown in Figure 5-3.

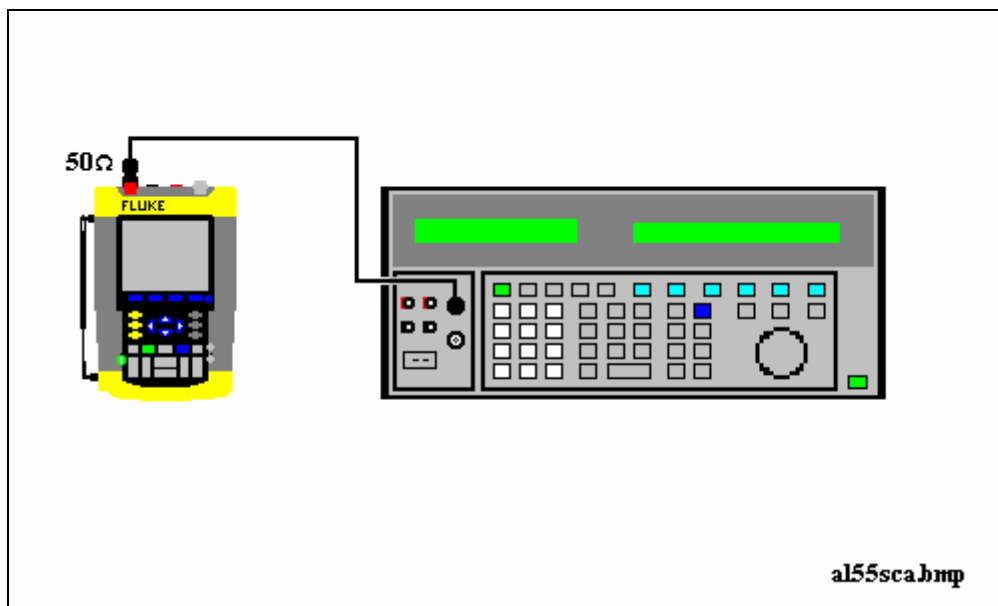

Figure 5-3. 5500A SCOPE Output to Test Tool Input A

al55sca.bmp

2. The display must show step CL 0654. If it does not, then press **F1** or **F2** to select the first calibration step in Table 5-1.
3. Set the 5500A SCOPE output to source the signal required for the first calibration point in Table 5-1.
4. Set the 5500A in operate (OPR) or standby (STBY) as indicated.
5. Press **F3** to start the calibration.
6. Wait until the display shows calibration status **:READY**.
7. Press **F2** to select the next calibration step, set the 5500A to the next calibration point signal, and start the calibration.  
Continue through all calibration points of Table 5-1.
8. When you are finished, set the 5500A to Standby.
9. Continue at Section 5.6.2.

**Table 5-1. Input A LF-HF Gain Calibration Points**

Cal step	UUT input signal	5500A Setting
CL 0654	none	STANDBY
CL 0400	0.5 Vpp square wave, 1 kHz	SCOPE edge, 0.5 Vpp, 1 kHz
CL 0704	none	STANDBY
CL 0420	0.5 Vpp square wave, 1 kHz	SCOPE edge, 0.5 Vpp, 1 kHz
CL 0480	0.5 Vpp sine wave, 50 kHz	SCOPE levsine, 0.5 Vpp, 50 kHz
CL 0481	0.5 Vpp sine wave Fluke 199B-C, 225C: 221 MHz Fluke 196B-C, 215C: 141 MHz Fluke 192B-C: 91 MHz	SCOPE levsine, 0.5 Vpp, 221 MHz 141 MHz 91 MHz

### 5.6.2 Input B LF-HF Gain

Proceed as follows to do the Input B LF-HF Gain calibration:

1. Press **F2** to select the first calibration step in Table 5-2.
2. Connect the test tool to the 5500A as shown in Figure 5-4.

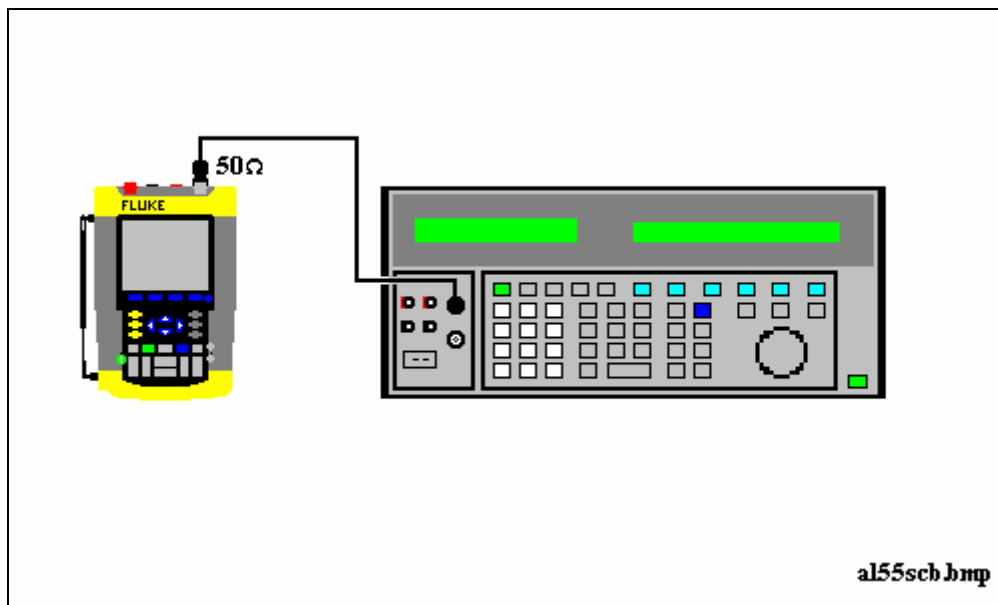

al55scb.bmp

Figure 5-4. 5500A SCOPE Output to Test Tool Input B

3. Set the 5500A SCOPE output to source the signal required for the first calibration point in Table 5-2.
4. Set the 5500A in operate (OPR) or standby (STBY) as indicated.
5. Press **F3** to start the calibration.
6. Wait until the display shows calibration status **:READY**.
7. Press **F2** to select the next calibration step, set the 5500A to the next calibration point signal, and start the calibration.  
Continue through all calibration points of Table 5-2.
8. When you are finished, set the 5500A to Standby.
9. Continue at Section 5.6.3.

Table 5-2. Input B LF-HF Gain Calibration Points

Cal step	UUT input signal	5500A Setting
CL 0674	none	STANDBY
CL 0410	0.5 Vpp square wave, 1 kHz	SCOPE edge, 0.5 Vpp, 1 kHz
CL 0724	none	STANDBY
CL 0421	0.5 Vpp square wave, 1 kHz	SCOPE edge, 0.5 Vpp, 1 kHz
CL 0482	0.5 Vpp sine wave, 50 kHz	SCOPE levsine, 0.5 Vpp, 50 kHz
CL 0483	0.5 Vpp sine wave Fluke 199B-C, 225C: 221 MHz Fluke 196B-C, 215C: 141 MHz Fluke 192B-C: 91 MHz	SCOPE levsine, 0.5 Vpp, 221 MHz 141 MHz 91 MHz

### 5.6.3 Input A&B LF-HF Gain

Proceed as follows to do the Input A&B LF-HF Gain calibration.

1. Press **F2** to select the first calibration step in Table 5-3.
2. Connect the test tool to the 5500A as shown in Figure 5-5.

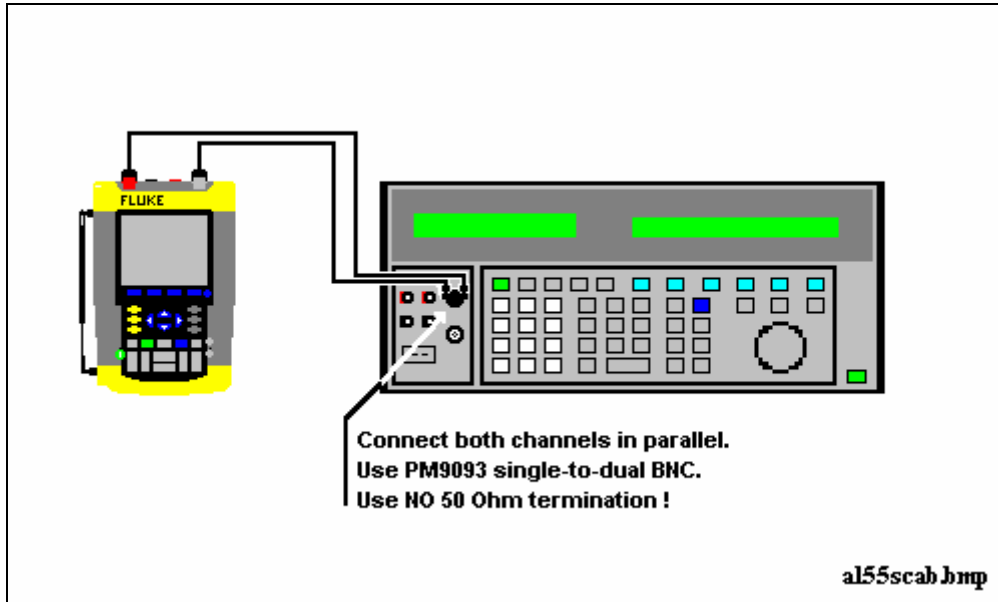

Figure 5-5. Test tool Input A&B to 5500 Scope Output

3. Set the 5500A to supply a 1 kHz square wave (SCOPE, MODE volt, SCOPE Z 1 M $\Omega$ ), to the first calibration point in Table 5-3.

#### **Warning**

**Dangerous voltages will be present on the calibration source and connection cables during the following steps. Ensure that the calibrator is in standby mode before making any connection between the calibrator and the test tool.**

4. Set the 5500A to operate (OPR).
5. Press **F3** to start the calibration.
6. Wait until the display shows calibration status **:READY**.
7. Press **F2** to select the next calibration step, set the 5500A to the next calibration point, and start the calibration. Continue through all calibration points of Table 5-3.
8. Set the 5500A to Standby, and continue at Section 5.6.4.

**Table 5-3. Input A&B Gain Calibration Points**

Cal step	UUT input value (5500A SCOPE, MODE volt, SCOPE Z 1 MΩ, 1 kHz)
CL 0660	300 mV
CL 0604	500 mV
CL 0637	none (5500 standby)
CL 0504	500 mV
CL 0624	none (5500 standby)
CL 0599 Not for software versions V05.01 and V05.02	10 mV
CL 0600	25 mV
CL 0601	50 mV
CL 0602	100 mV
CL 0603	250 mV
CL0662	2 V
CL 0605	1 V
CL 0606	2.5 V
CL 0607	5 V
CL0664	20 V
CL 0608	10 V
CL 0609	25 V
CL 0610	50 V (set 5500A to OPR!)

#### **5.6.4 Input A&B Position**

Proceed as follows to do the Input A&B Position calibration:

1. Press **F2** to select calibration adjustment step **CL 0620** (software versions V05.01 and V05.02), or **CL 0619** (software versions V05.03 and newer).
2. Remove all Input A and Input B connections (open inputs).
3. Press **F3** to start the calibration
4. Wait until the display shows calibration status **:READY**.
5. Continue at Section 5.6.5

### 5.6.5 Input A&B Volt Gain

#### Warning

Dangerous voltages will be present on the calibration source and connection cables during the following steps. Ensure that the calibrator is in standby mode before making any connection between the calibrator and the test tool.

Proceed as follows to do the Input A&B Volt Gain calibration.

1. Press **F2** to select the first calibration step in Table 5-4.
2. Connect the test tool to the 5500A as shown in Figure 5-6.

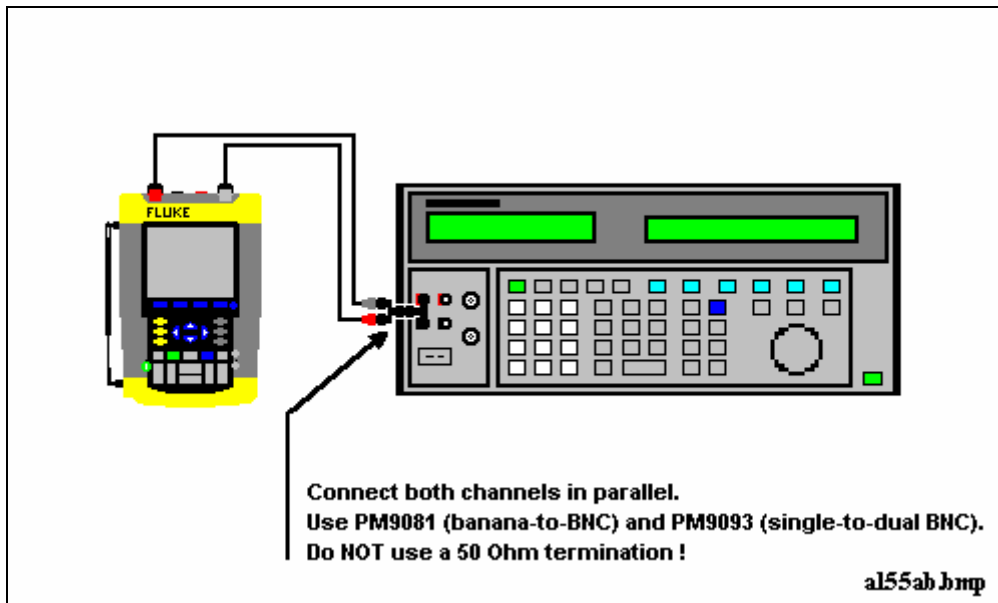

Figure 5-6. Test tool Input A&B to 5500 Normal Output

3. Set the 5500A to supply a DC voltage (NORMAL output), to the first calibration point in Table 5-4.
4. Set the 5500A to operate (OPR).
5. Press **F3** to start the calibration.
6. Wait until the display shows calibration status **:READY**.
7. Press **F2** to select the next calibration step, set the 5500A to the next calibration point, and start the calibration. Continue through all calibration points of Table 5-4.
8. Set the 5500A to Standby, and continue at Section 5.6.6.

**Table 5-4. Input A&B Gain Calibration Points**

Cal step	UUT input value (5500A NORMAL)
CL 0824	250 mV
CL 0799 Not for software versions V05.01 and V05.02	5 mV
CL 0800	12.5 mV
CL 0801	25 mV
CL 0802	50 mV
CL 0803	125 mV
CL 0805	500 mV
CL 0806	1.25 V
CL 0807	2.5 V
CL 0808	5 V
CL 0809	12.5 V
CL 0810	25 V
CL 0811	50 V (set 5500A to OPR!)
CL 0812	125 V
CL 0813	250 V

### 5.6.6 DMM Volt Gain



#### Warning

**Dangerous voltages will be present on the calibration source and connection cables during the following steps. Ensure that the calibrator is in standby mode before making any connection between the calibrator and the test tool.**

Proceed as follows to do the DMM Volt Gain calibration.

1. Press  to select the first calibration step in Table 5-5.
2. Connect the test tool to the 5500A as shown in Figure 5-7.

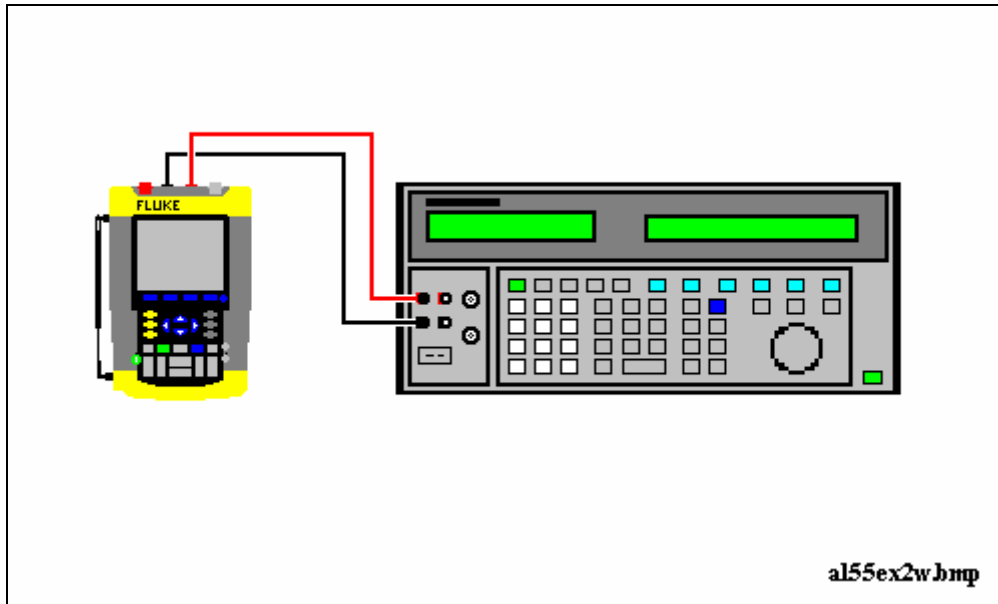

Figure 5-7. 5500A NORMAL Output to Test Tool Banana Input

3. Set the 5500A to supply a DC voltage, to the first calibration point in Table 5-5.
4. Set the 5500A to operate (OPR).
5. Press **F3** to start the calibration.
6. Wait until the display shows calibration status **:READY**.
7. Press **F2** to select the next calibration step, set the 5500A to the next calibration point, and start the calibration. Continue through all calibration points of Table 5-4
8. Set the 5500A to Standby, and continue at Section 5.6.7.

Table 5-5. DMM Gain Calibration Points

Cal step	UUT input value (5500A NORMAL)
CL 0840	500 mV
CL 0849	2.5 V
CL 0841	5 V
CL 0842	50 V (set 5500A to OPR!)
CL 0843	500 V
CL 0844	1000 V

### 5.6.7 Input A & B, and DMM Zero

Proceed as follows to do the Input A&B, and the DMM Zero calibration:

1. Press **F2** to select calibration adjustment step CL0852
2. Short circuit Input A and Input B.

3. Short circuit the banana jack Meter inputs properly (calibration includes Ohms zero!).
4. Press **F3** to start the zero calibration
5. Wait until the display shows the status **:READY**.
6. Remove the input terminations.
7. Continue at Section 5.6.8.

### 5.6.8 DMM Ohm Gain

Proceed as follows to do the DMM Ohm Gain calibration:

1. Press **F2** to select first calibration adjustment step in Table 5-6.
2. Connect the test tool to the 5500A as shown in Figure 5-8.  
Notice that the sense leads must be connected directly to the test tool.

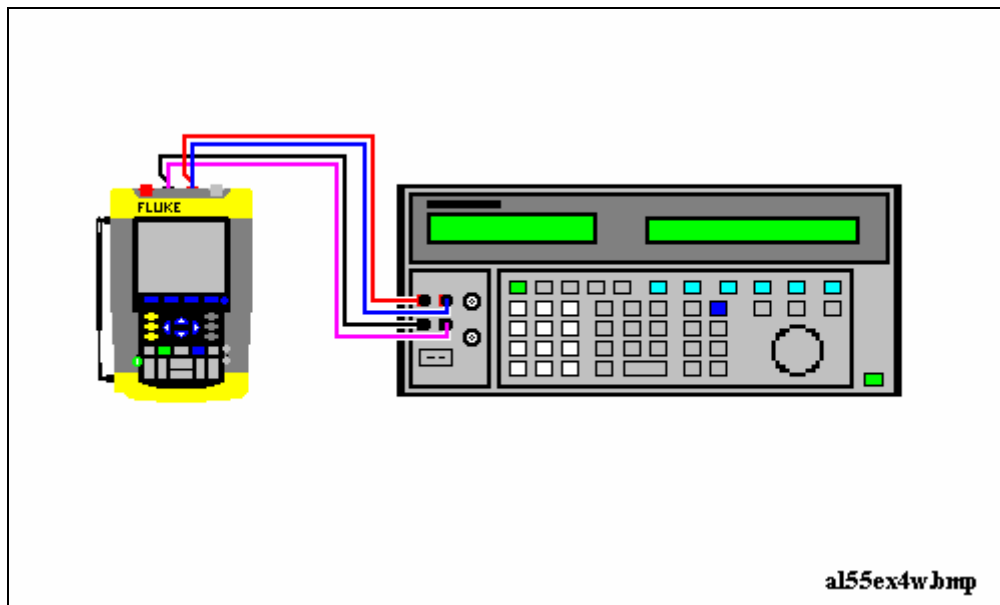

Figure 5-8. Four-wire Ohms calibration connections

al55ex4w.bmp

3. Set the 5500A to the first test point in Table 5-6. Use the 5500A “COMP 2 wire” mode for the calibration adjustments up to and including 100 k $\Omega$ . For the higher values, the 5500A will turn off the “COMP 2 wire” mode.
4. Set the 5500A to operate (OPR).
5. Press **F3** to start the calibration.
6. Wait until the display shows the calibration status **:READY**.
7. Press **F2** to select the next calibration step, set the 5500A to the next calibration point, and start the calibration. Continue through all calibration points.
8. When you are finished, set the 5500A to Standby.
9. Continue at Section 5.6.9.

Table 5-6. Ohm Gain Calibration Points

Cal Step	UUT input Value (5500 NORMAL)
CL 0910	100 Ω
CL 0911	1 kΩ
CL 0912	10 kΩ
CL 0913	100 kΩ
CL 0914	1 MΩ
CL 0915	10 MΩ

### 5.6.9 Calculate Gain

1. Remove all test leads from the test tool inputs.
2. Press **F2** to select calibration adjustment step CL 0920.
3. Press **F3** to start the calibration.
4. Wait until the display shows the calibration status :**READY**.
5. Continue at section 5.7

### 5.7 Save Calibration Data and Exit

Proceed as follows to save the calibration data, and to exit the Maintenance mode:

1. Remove all test leads from the test tool inputs.
2. Press **F4** **EXIT**. The test tool will display:

**Calibration data valid.  
Save data and exit maintenance mode?**

*Note*

*Calibration data valid indicates that the calibration adjustment procedure is performed correctly. It does not necessarily mean that the test tool meets the characteristics listed in Chapter 2.*

3. Press **F4** **YES** to save and exit.

*Note 1*

*After saving the calibration data, the calibration number and - date will be updated if the calibration data have been changed and the data are valid. The calibration number and - date will not change if:*  
*- the calibration mode is entered and left without doing a calibration adjustment.*  
*- only the contrast calibration adjustment (5.4) and/or the probe calibration is done.*

*Note 2*

*If you press **F3** **NO**, the test tool returns to the calibration mode. You can either calibrate the test tool again, or press **F4** **EXIT**, **F4** **YES** to save and exit.*

**Possible error messages.**

The following messages can be shown on the test tool display:

**WARNING: Calibration data not valid.**  
**Save data and exit maintenance mode?**

Proceed as follows:

- If you did the WarmingUp and Pre-Calibration successfully (section 5.5), and you want to store the Pre-Calibration data before continuing with the Final Calibration:

⇒ Press  **YES**.

When turning the test tool off and on again, it will show the message:

**The instrument needs calibration.**  
**Please contact your service center.**

The calibration date and number will not be updated. You must continue with the Final Calibration!

- To return to the Maintenance mode, if you want to repeat the complete calibration:

⇒ Press  **NO**.

Now press  until the display shows **WarmingUp (CL 0200):IDLE**, and calibrate the test tool, starting at section 5.5.

- If you want to exit and maintain the old calibration data:

⇒ Turn the test tool off.

## 5.8 Probe Calibration

To meet full user specifications, you need to adjust the supplied red and gray VPS200 voltage probes for optimal response.

To adjust the VPS200 probes, do the following:

1. Connect the red probe from the red Input A BNC to the banana jacks. See figure 5-9

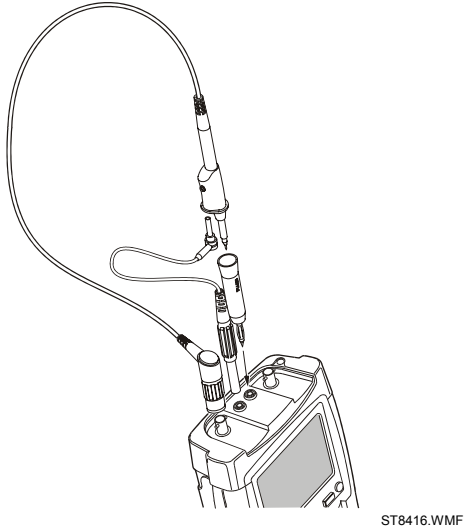
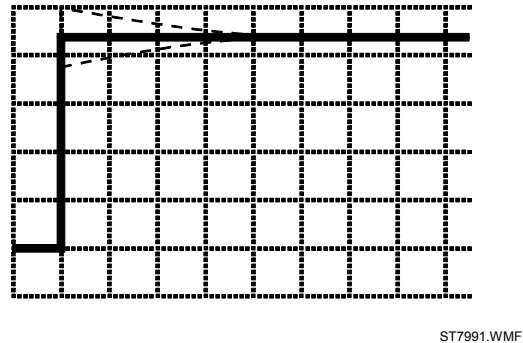

Figure 5-9. 10:1 Probe Calibration Connection



ST7991.WMF

Figure 5-10. 10:1 Probe Calibration

2. Press **A** , and then **F3** to open the **Probe on A** menu
3. Select Probe Type: **■ Voltage | Attenuation: ■ 10:1 , ■ Probe Cal...**
4. Press **F4** to start the probe calibration. A square wave appears on the screen. See Figure 5-10 (the lower half of the screen is covered with operating instructions).
5. Adjust the trimmer screw in the probe housing until a pure square wave is displayed.
6. Press **F4** to continue with automatic dc calibration.  
The test tool automatically calibrates itself to the probe. A message indicates that the dc calibration has been completed successfully.
7. Repeat the procedure for the gray VPS200 probe, connected from the gray Input B BNC to the banana jacks.



## **Chapter 6**

# ***Disassembling the Test Tool***

<b>Title</b>	<b>Page</b>
6.1. Introduction.....	6-3
6.2. Disassembly & Reassembly Procedures .....	6-3
6.2.1 Required Tools .....	6-3
6.2.2 Removing the Tilt Stand & Hang Strap.....	6-3
6.2.3 Replacing the Side-Strap, Changing the Side-Strap Position.....	6-3
6.2.4 Opening the Test Tool, Removing the Battery.....	6-3
6.2.5 Removing the Main PCA Unit and the Fan.....	6-5
6.2.6 Removing the Display Assembly .....	6-6
6.2.7 Replacing the LCD Window/Decal .....	6-7
6.2.8 Removing the Keypad and Keypad Foil.....	6-7
6.2.9 Disassembling the Main PCA Unit .....	6-7
6.2.10 Reassembling the Main PCA Unit.....	6-8
6.2.11 Reassembling the Test Tool .....	6-9

## 6.1. Introduction

This section provides the required disassembling procedures. The printed circuit assembly removed from the test tool must be adequately protected against damage.

### Warning

**To avoid electric shock, disconnect test leads, probes and power supply from any live source and from the test tool itself. Always remove the battery pack before completely disassembling the test tool. Only qualified personnel using customary precautions against electric shock should work on a disassembled unit with power on**

## 6.2. Disassembly & Reassembly Procedures

### 6.2.1 Required Tools

To access all the assemblies, you need the following:

- Static-free work surface, and anti-static wrist wrap.
- #10 Torx screwdriver.
- Cotton gloves (to avoid contaminating the lens, and the PCA).

### 6.2.2 Removing the Tilt Stand & Hang Strap

Use the following procedure to remove the tilt stand and hang strap (Figure 6-5, item 15 and item 10).

1. Set the tilt stand to a 45-degree position respective to the test tool bottom.
2. The hinge consists of a circular raised rim in the tilt stand that is located over a circular lowering in the bottom case. Pull sideward on the front edge of the tilt stand until the hinge releases. Then rotate the stand to the rear to remove it. You can remove the hangstrap now.

### 6.2.3 Replacing the Side-Strap, Changing the Side-Strap Position

The side-strap (figure 6-5, item 15) can be attached at the right or left side of the test tool. Use the following procedure to replace the strap, or to change the strap position.

1. To remove the strap, unfold the strap ends (provided with Velcro tape), and pull the ends out of the strap holders (item 16).
2. To change the strap position open the test tool (see Section 6.2.4), remove the strap with the strap holders, attach them to the other side, and reassemble the test tool.

### 6.2.4 Opening the Test Tool, Removing the Battery

Use the following procedure to open the test tool, and to remove the battery:

1. Loosen the two M3 Torx screws that secure the input cover (Figure 6-1).
2. Loosen the two M3 Torx screws that secure the bottom holster (Figure 6-2).
3. Pull off the input cover and the bottom holster (Figure 6-3).

4. Unscrew the two screws that lock the bottom case.
5. Lift the bottom case at the lower side to remove it.
6. Lift out the battery pack (Figure 6-4).
7. Unplug the cable leading to the Main PCA (pull the cable gently backwards).

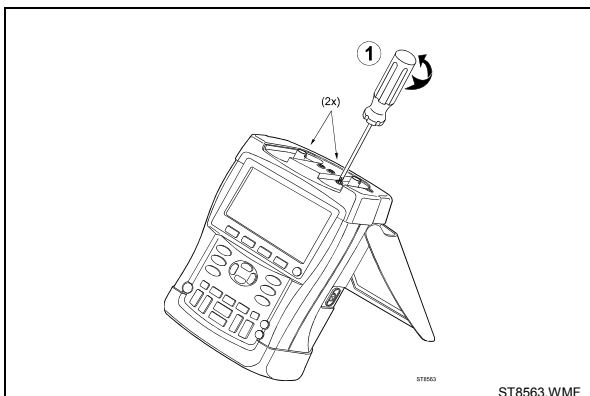

**Figure 6-1. Loosen 2 Input Cover Screws**

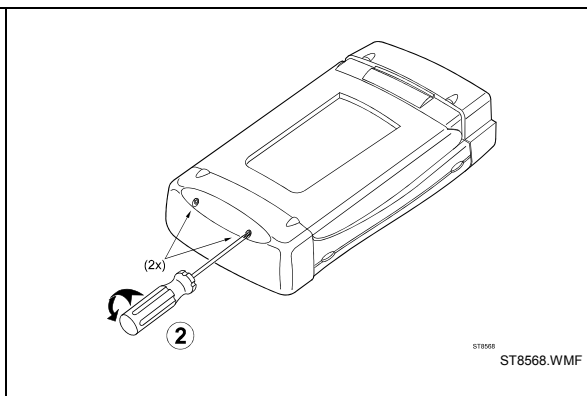

**Figure 6-2. Loosen 2 Bottom Holster Screws**

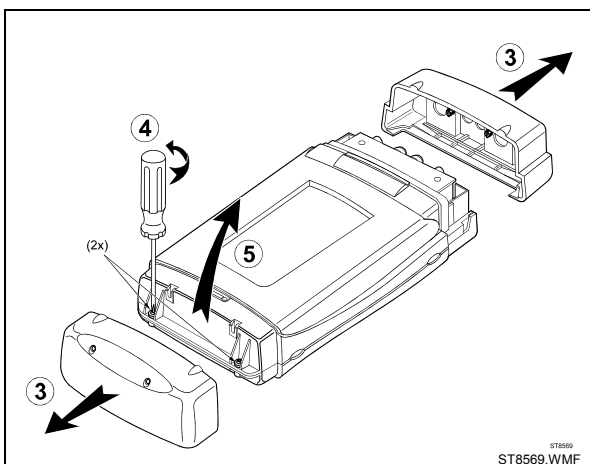

**Figure 6-3. Opening the Test Tool**

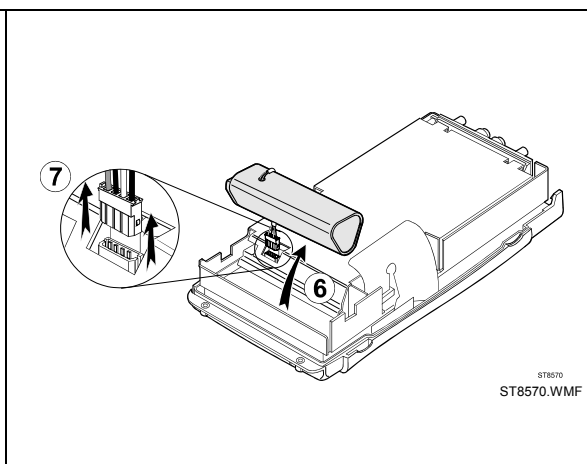

**Figure 6-4. Removing the Battery Pack**

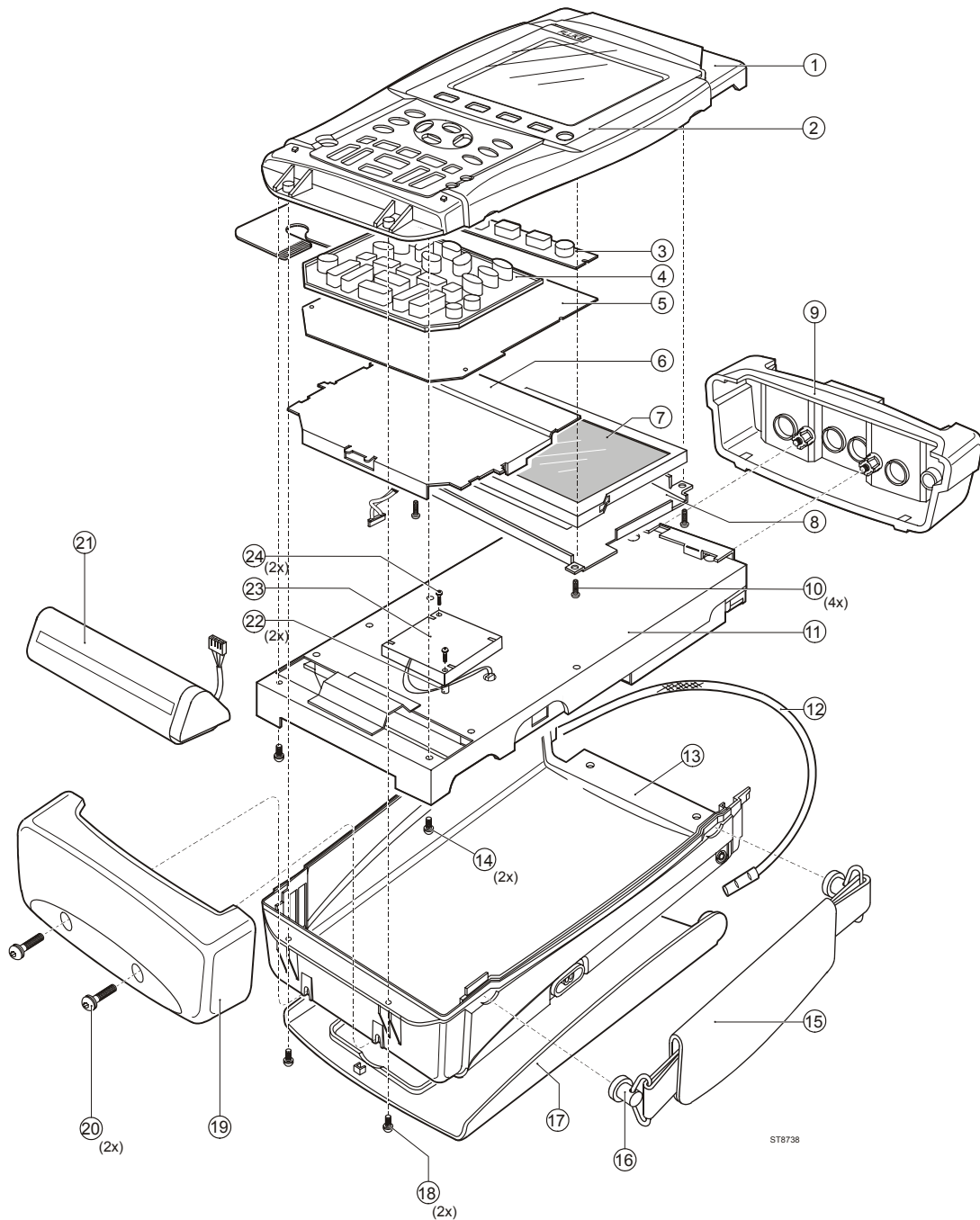

Figure 6-5. Final Assembly Details

ST8738.WMF

### 6.2.5 Removing the Main PCA Unit and the Fan

#### Caution

To avoid contaminating the flex cable contacts with oil from your fingers, do not touch the contacts (or wear gloves). Contaminated contacts may not cause immediate instrument failure in controlled environments. Failures typically show up when contaminated units are operated in humid areas.

Referring to Figure 6-5, use the following procedure to remove the main PCA unit.

1. Open the test tool (see Section 6.2.4).
2. Disconnect the blue keypad foil (item 5) flat cable, and the white LCD (item 7) flex cable. Unlock each cable by lifting the connector latch at the left and right edge using a small screw-driver, see Figure 6-6. The latch remains attached to the connector body.

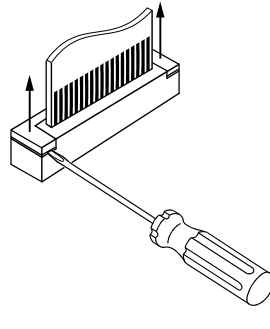

**Figure 6-6. Flex Cable Connectors**

ST8682.WMF

3. Unplug the two-wire backlight cable.

### **Warning**

**If the battery pack or the power adapter is connected, the LCD backlight voltage on the wire cable is 400V ! (when the test tool is on).**

4. Remove the two screws (item 14) that secure the Main PCA unit to the top case.
5. Slide the Main PCA unit in the input cover direction to remove it.
6. To remove the fan from the main PCA unit, unplug the fan connector and unscrew the screws item 24.

## **6.2.6 Removing the Display Assembly**

There are no serviceable parts in the display assembly. Referring to Figure 6-5, use the following procedure to remove the display assembly.

1. Remove the main PCA unit (see Section 6.2.5).
2. Unscrew the four screws item 10.
3. Remove the display assembly (item 7) with the mounting frame (item 8).  
To prevent finger contamination, wear cotton gloves, or handle the display assembly by its edges.
4. Remove the display from the mounting frame.

### **6.2.7 Replacing the LCD Window/Decal**

The LCD window/decal (Figure 6-5, item 2) is glued on the top cover. To replace it do the following:

1. From the inside of the top cover push the window outwards until it comes off.
2. Carefully remove remains of glue from the top cover. The bulk of the glue can be removed with sticky tape. This action must be completed by cleaning the surface with alcohol.
3. Remove the protection foil from the new window
4. Firmly press the new window on the top cover.

### **6.2.8 Removing the Keypad and Keypad Foil**

#### **Caution**

**To avoid contaminating the keypad contacts, and the keypad foil contacts with oil from your fingers, do not touch the contacts (or wear gloves). Contaminated contacts may not cause immediate instrument failure in controlled environments. Failures typically show up when contaminated units are operated in humid areas.**

Referring to Figure 6-5, use the following procedure to remove the keypad and the keypad foil.

1. Remove the display assembly (see Section 6.2.6).
2. Remove the keypad support plate item 6.
3. Remove the keypad foil item 5. Notice the keypad foil positioning pins in the top case for reassembly.
4. Remove the keypads item 3 and item 4.

### **6.2.9 Disassembling the Main PCA Unit**

#### **Caution**

**To avoid contaminating the main PCA with oil from your fingers, do not touch the contacts (or wear gloves). A contaminated PCA may not cause immediate instrument failure in controlled environments. Failures typically show up when contaminated units are operated in humid areas.**

Referring to Figure 6-7, use the following procedure to disassemble the main PCA unit.

1. Unscrew the four M3x10 Torx screws (items 9) that secure the shielding cover (item 8), and remove the shielding cover.
2. Unscrew the M3x15 standoffs (item 10) that secure the PCA to the shielding box item 1.
3. Remove the PCA from the shielding box.
4. To remove the isolation strip pull one end out of the sleeves in the PCA (pull at points A). Then pull out the other end (pull at points B).

5. To get access to the input circuits on the PCA, unscrew the Torx screws item 7 and remove the metal input circuit shielding boxes.

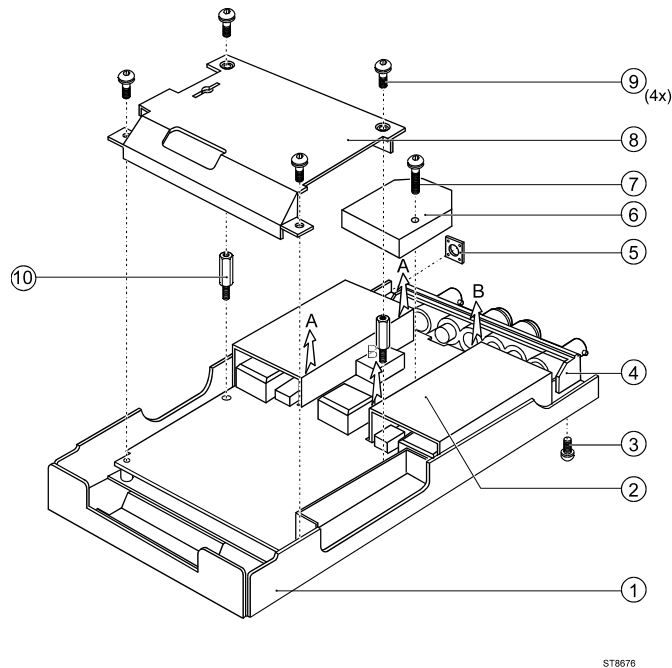

Figure 6-7. PCA Unit Assembly

### 6.2.10 Reassembling the Main PCA Unit

Reassembling the main PCA unit is the reverse of disassembly (see figure 6.7). However you must follow special precautions when reassembling the main PCA unit.

1. Install the metal input circuit shielding boxes (items 6) carefully. Take care that the notches at the edges of the boxes match the holes in the PCA. The plate spring in the Input A and Input B box must touch the C-ASIC N1000 (Input A) or N1200 (Input B) for cooling. Do not bend the springs!

#### Caution

**A good thermal coupling between the C-ASIC's (N1000, N1200) and the input boxes is achieved by self adhesive thermal conductive pads. These pads can either be stuck on the spring in the box, or on the C-ASIC. If stuck on the C-ASIC, you can reuse the pad when replacing the C-ASIC.**

2. Attach the isolation strip carefully! Insert the ends of the strip into the slots in the PCA, and push firmly until the strip is in its original position.
3. Put the PCA in the shielding box, and fasten the 2 hexagonal standoffs (item 10).
4. Attach the shielding cover (item 8). Ensure that the small optical gate PCA mounted on the main PCA sticks through the slot in the shielding cover.
5. Ensure that the rubber sealing ring (item 5) for the power connector is present

### **6.2.11 Reassembling the Test Tool**

Reassembling the test tool is the reverse of disassembly. However you must follow special precautions when reassembling the test tool. Refer to figure 6-5.

Reassembling procedure for a completely disassembled unit:

1. Clean the inside of the lens with a moist soft cloth if necessary. Keep the lens free of dust and grease.
2. Install the keypads item 3 and item 4. Press the edges of the keypads into the sealing groove of the top case. Ensure that the keypads lay flat in the top case, and that all keys are correctly seated.
3. Install the keypad foil item 5. Align the positioning holes in the keypad foil to the positioning pins in the top case.
4. Install the keypad support plate item 6.
5. Clean the display glass with a moist soft cloth if necessary. Install the display assembly and its mounting frame, and fasten the 4 screws (item 10).
6. Verify that the fan cable connector is plugged into the Main PCA fan connector.
7. Slide the Main PCA unit into the Top Case from the display end. Make sure that the tabs on the Shielding Box go into the slots in the top of the Top Case. Fasten with the 2 screws (item 14).
8. Verify that the backlight wires are twisted to minimize interference voltages. Reattach the backlight cable. Reattach the LCD flex cable, secure that cable in the connector with the connector latch.
9. The keypad foil is provided with a grounded shielding flap that covers the backlight cable. This decreases the electromagnetic emission. The flap should cover the cable connection area and lay over the PCA shield. Reattach the keypad flex cable, secure the flat cable in the connector with the connector latch.
10. Install the battery pack, and re-attach the cable.
11. Install the bottom case with the strap holders and strap, and fasten the 2 screws item 18.
12. With the bottom cover up, start the screws (item 20) into the square nuts, then press in on the bottom holster to latch the tabs on the top case. Finish tightening the 2 screws.
13. Slide the input cover on and fasten with the 2 M3 Torx screws.
14. Calibrate the display contrast (see section 5.4) if you replaced the display.