

Cal Power

Via Acquanera, 29 22100 COMO
tel. 031.526.566 (r.a.) fax 031.507.984
info@calpower.it www.calpower.it

FLUKE®

Calibration

The Fluke 6105A and 6100B Electrical Power Standards



The most accurate, comprehensive and flexible
sources of electrical power quality and energy signals

Measurement validation for electrical power quality and energy applications

Deregulation and the increasingly distributed nature of today's power supply network mean that power and energy measurements must be made more frequently, with a higher degree of accuracy. At the same time, the environment in which these measurements are being made has become more hostile to good measurement practice. Harmonic distortion, voltage fluctuations, phase imbalances and other extraneous, re-injected signal components provide an alien environment for measurement devices designed to operate primarily on sinusoidal signals.

Global moves to smart metering and smart grid technology require better measures of electricity bought and sold between generation and distribution organizations, and ultimately consumers. Smart meters and “in-home-displays” will allow consumers to better understand and control their usage of electricity and ask educated questions about their bills.

As accuracy specifications get tighter, measurement techniques become more important. For many years, energy meters have been calibrated by comparing the meter under test with a reference standard meter. This method, sometimes called “transfer calibration,” also requires a voltage source and a method of controlling the current measured by the device under test (DUT) and the standard meter. One established method of providing the source signal is to apply the local electricity supply to a variable load, to cause approximately known currents to flow. The DUT and standard meter measure the main supply voltage and load induced current, and the results from both are compared to provide the calibration of the DUT.

A shortcoming in this method is that the main supply voltage is rarely sinusoidal. “Flat topping” of the voltage waveform is a common distortion.

For example, industrial variable speed machinery use dc rectified from the ac main supply. Rectifier capacitor charging currents cause flat topping of the voltage waveform. The flat topped waveform contains significant in-phase odd harmonics. If the test system load is linear, corresponding harmonics appear in the current waveform. If the reference standard meter and DUT had identical responses, systematic errors would not be an issue. However, this is an optimistic view. Reference standard meter and DUT bandwidth differences can give rise to significant errors. The harmonic content of the signals is not known, so it is not possible to assess the magnitude of error for any given measurement sequence.

The problem of flat topped mains voltage has been overcome by using relatively inaccurate but stable programmable voltage and current sources to produce “phantom power,” where the phase angle between voltage and current and their amplitudes are independent. These sources are not meant to contribute to the measurement accuracy, and they do not if the outputs are exactly as demanded and stable. The method still has disadvantages, but the potential for error is reduced.

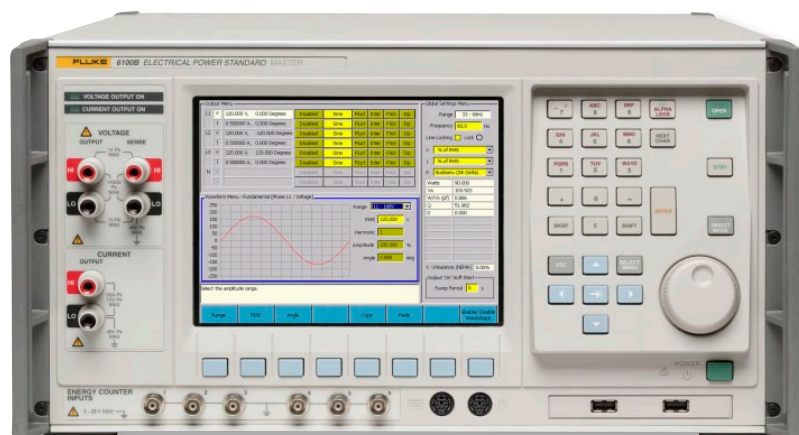

6100B

The most accurate solutions: 6105A and 6100B

In 2002, Fluke launched the 6100A and 6101A Electrical Power Standards. The 6100A/6101A combined source stability with reference accuracy in a single product.

The 6100A and 6101A have now been replaced by the 6100B and 6101B. These newer models have the same power quality and functionality as their predecessors, to comfortably meet the accuracy requirements for power quality testing standards. In addition, they feature improved accuracy to match that of the best measurement devices for sinusoidal waveforms.

Few systems can match the 0.007 % (66 ppm) one year energy accuracy provided by the 6105A for sinusoidal waveforms. Waveforms with high harmonic distortion are delivered with similar accuracy traceable to national and international standards.

Choosing between a 6100B or 6105A depends on your accuracy requirements. Both models meet all accuracy requirements of power quality testing to the IEC 61000-4 series of standards. The 6100B can also be used to type test 0.1 % to 2 % energy meters.

Choose the 6105A when you need the highest accuracy available for calibrating secondary standard meters, energy revenue meters and type test applications.

The 6100B and 6101B also include increased voltage channel current drive, for calibrating energy meters which take power from their voltage input.



6101B



6106A

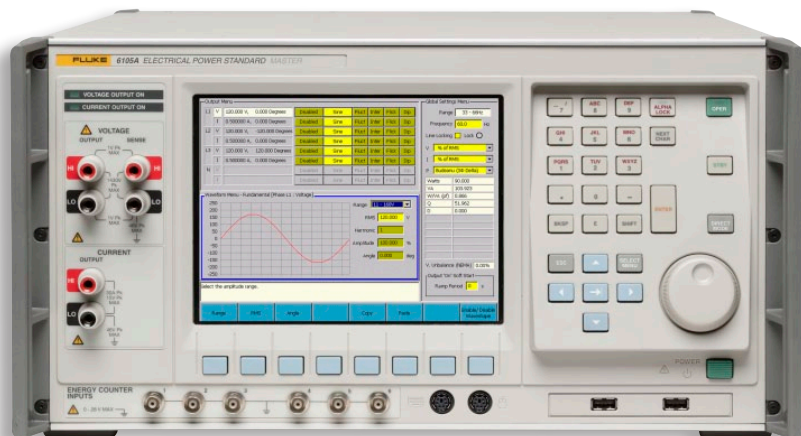

The 6105A provides the accuracy required to verify the performance of secondary standards such as those produced by Radian Research, Zera, and MTE.

6105A

Comprehensive functionality

Who needs a 6105A or 6100B?

Validation of electrical power quality and energy measurements and the equipment that make them is required in many disciplines:

- In National Measurement Institutes (NMI) to provide precise non-sinusoidal signals and phantom power in various research applications
- In research and design to validate the function and accuracy of prototypes and first-off production units
- In manufacturing test to make certain that measurements are correct and repeatable on every unit manufactured
- In service and calibration to ensure that instruments continue to perform to specification throughout their lifetime

- In standards laboratories to calibrate secondary standards used in large scale production calibration of power quality and energy meters

The Fluke 6105A and 6100B provide the signals to allow the processes described above to be completed effectively, quickly and by lower skill operators. More importantly, it ensures that the process of validation can be completed thoroughly, accurately and with all measurements being traceable to national and international standards. The 6100A was designed to produce a comprehensive array of electrical power quality signals with exceptional accuracy over one, two, three or four phases independently and simultaneously.

Wide workload coverage

The 6105A and 6100B cover a wide workload of electrical power test instruments, including:

- AC voltmeters
- AC ammeters

- Current transformers
- Flicker Meters
- Phase angle meters
- Power factor meters
- Power analyzers
- Power recorders
- Power transducers- Relay testers
- VA meters
- VAR meters
- Voltage transformers
- Wattmeters (3- or 4-wire)
- Watthour meters
- and more

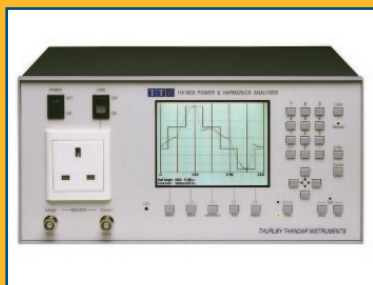

Complex measurements

Flicker

Flicker is a complex measurement which sets out to measure the “annoyance factor” of a flickering light caused by modulation on its supply voltage, most often caused by switching of large loads. There are many implementations of “flickermeter,” the testing and calibration of which is defined in IEC standard IEC-61000-4-15. This standard defines the various combinations of modulation shape, depth and frequency to be used to

qualify “flickermeter classifiers.” The 6105A and 6100B generate all the flicker signals required for calibration by this standard and displays the resulting Pst with an accuracy of 0.25 %. This is 20 times better than required by 61000-4-15. New flicker mechanisms including frequency/amplitude changes and phase jumps are in a 61000-4-15 update under review before release. The 6105A and 6100B implement these new functions to support design groups working on new flickermeters to comply with the new standards.

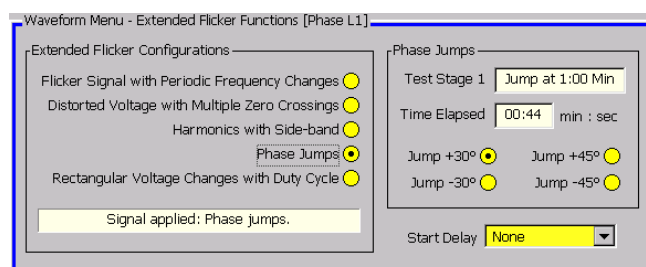
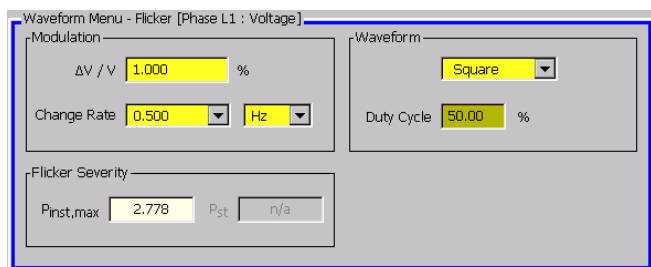

Harmonics

In addition to very accurate sinusoidal voltages and currents, the 6105A and 6100B can add accurate harmonic distortion independently on the voltage and current outputs. The accuracy of the resultant non-sinusoidal waveforms is specified and is traceable to national and international standards. All of the first 100 harmonics can be set individually by the user, with levels of up to 30 % of the

fundamental value. Accurate harmonically distorted waveforms are essential for type test and calibration of power and energy meters. Other instruments that require accurate non-sinusoidal waveforms include harmonic analyzers, power loggers, and disturbance analyzers. The 6105A and 6100B harmonic accuracy comfortably better the requirements of IEC 61000-4-7 and 61000-4-13.

The 6105A and 6100B harmonic accuracy comfortably better the requirements of IEC 61000-4-7 and 61000-4-13.

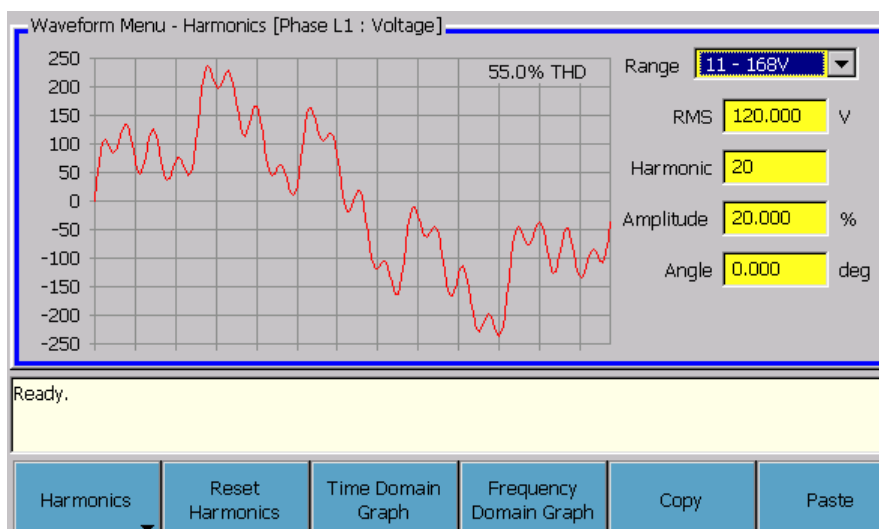

Complex measurements cont.

Dips and swells

Output voltage or current can be caused to dip to a level below nominal or swell to a level above nominal for a period of between 1 ms and one minute. Ramp in and ramp out times, period, repetition delay and dip/swell level are all independently controllable. The dip or swell can be triggered internally to start

at a particular phase angle or time delay set by the user; or triggered externally via a BNC connector on the rear panel. The 6105A and 6100B can be used to verify the performance of equipment used for testing immunity to voltage dips, short interruptions and voltage variations as specified in IEC 61000-4-11.

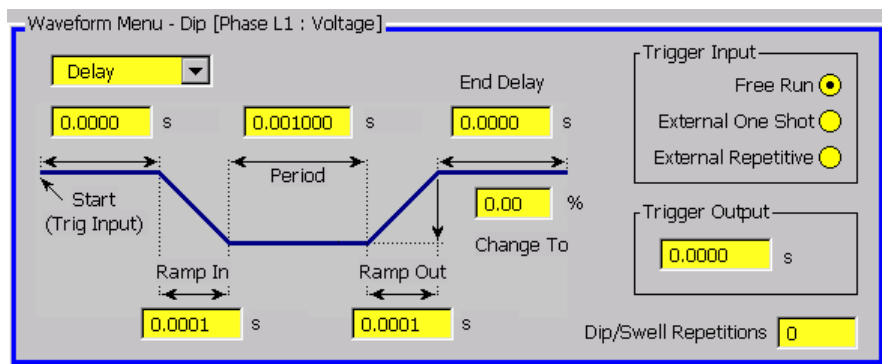

The 6105A and 6100B can be used to verify the performance of equipment used for testing immunity to voltage dips, short interruptions and voltage variations as specified in IEC 61000-4-11.

Interharmonics

Interharmonics are continuous signal elements unrelated to the fundamental frequency. For example, in a 60 Hz supply system, 180 Hz is a harmonic (the third) but 190 Hz is an interharmonic. The 6105A and 6100B can generate independent Interharmonics at a user-definable level and frequency up to 9 kHz on current or voltage outputs or both.

With this function, the 6100B can simulate Interharmonics caused by imperfect loads, or deliberately induced signals such as power line carrier signals. Interharmonics are a requirement to meet the multi-condition testing situations in IEC 61000-4-30 and IEC 61000-4-34.

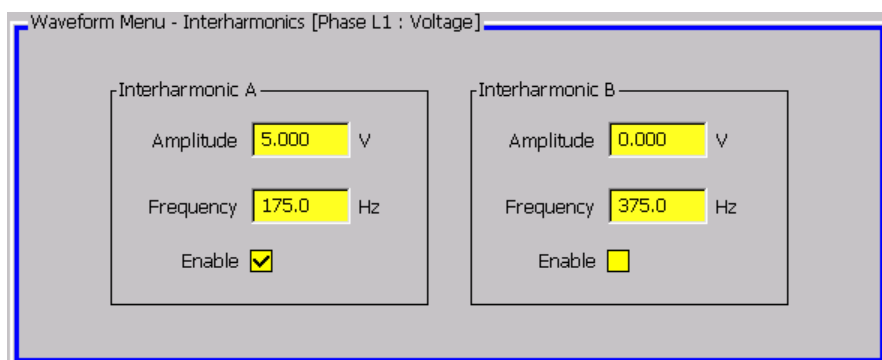

Interharmonics are a requirement to meet the multicondition testing situations in IEC 61000-4-30 and IEC 61000-4-34.

Complex measurements cont.

Fluctuating harmonics

Fluctuating harmonics are individual harmonics which are amplitude modulated. The 6100B is able to individually modulate from one to every currently defined harmonic at up to 30% of its nominal amplitude with a frequency of

0.008 Hz to 30 Hz; with a sinusoidal, square or rectangular modulation wave shape. The 6105A and 6100B can be used to verify the performance of equipment used for testing immunity to fluctuating harmonics as specified in IEC 61000-4-14.

The 6105A and 6100B can be used to verify the performance of equipment used for testing immunity to fluctuating harmonics as specified in IEC 61000-4-14.

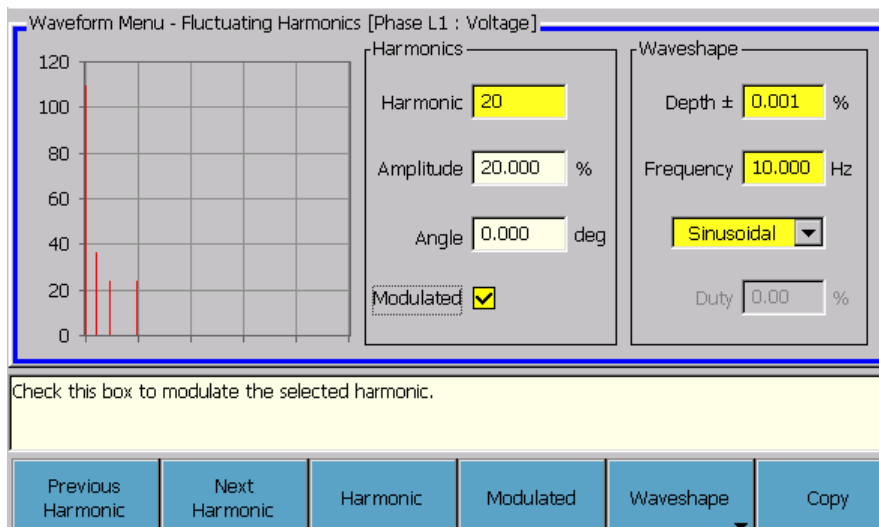

Simultaneous application

Full verification of complex measurement devices requires that complex combinations of signals are handled correctly. This fact has been recognized within the power measurement industry, and is incorporated in IEC 61000-4-30 and 61000-4-34 (testing and measurement techniques—power quality

measurement methods). These standards require, among other things, that measurement instruments are tested with compound signal types (for example flicker, imbalance and harmonics all present) to ensure that performance is maintained under real world conditions. Fluke 6105A and 6100B meet all the requirements of the standards.

Fluke 6105A and 6100B testing ensures that performance is maintained under real world conditions.

Output Menu									
L1	V	120.000 V,	0.000 Degrees	Enabled	Harmonics	Fluct	Inter	Flick	Dip
	I	0.500000 A,	0.000 Degrees	Enabled	Sine	Fluct	Inter	Flick	Dip
L2	V	120.000 V,	-120.000 Degrees	Enabled	Sine	Fluct	Inter	Flick	Dip
	I	0.500000 A,	-120.000 Degrees	Enabled	Sine	Fluct	Inter	Flick	Dip
L3	V	120.000 V,	120.000 Degrees	Enabled	Sine	Fluct	Inter	Flick	Dip
	I	0.500000 A,	120.000 Degrees	Enabled	Sine	Fluct	Inter	Flick	Dip
N	V			Disabled	Sine	Fluct	Inter	Flick	Dip
	I			Disabled	Sine	Fluct	Inter	Flick	Dip

Complex measurements cont.

Multi-phase operation

The 6105A and 6100B Master units offer self-contained single phase operation, with one voltage and one current output. For multi-phase applications, the addition of one or more 6106A or 6101B Auxiliary units provides additional phases, with identical performance but without the overhead of controls or display. Additional phases can be added individually until a maximum of four phases is reached. For added flexibility, the 6105A and 6100B Master units can be configured as Auxiliary devices within seconds. In multiphase systems, each phase remains totally independent and totally electrically isolated, yet synchronized with, and under the control of the master unit. This means applications where phase unbalance is required are simple and easy to arrange. Multiphase 6105A/6100B systems are necessarily connected together in four-wire, WYE configuration. Simulation of three-phase, three-wire Delta and three-phase, four-wire Delta is simply arranged by changing settings via the user interface.

80A and 50A options

Two higher current options are available. The 80A option provides 0A to 80A through 100 mm sockets. The outputs from the standard current ranges cannot be routed via these connectors. The 50A option provides 0A to 50A also through 100 mm sockets. With the 50A option the operator can choose to route all currents through the 100 mm sockets or use the 0A to 21A range outputs through the standard terminals.

Energy option

The energy option adds a comparator to the 6105A and 6100B. Six input channels can be individually configured for “Meter Constant.” The user has the choice of reference. The 6105A energy accuracy is as good as almost any external device; but the 6100B user may choose to use an external reference standard. Measured energy is compared with the reference value and a percentage error reported for each device being tested.

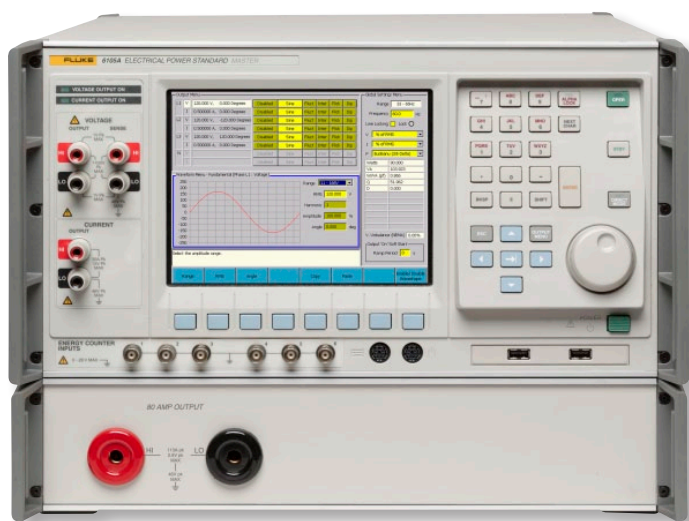

6105A/E/80A Electrical Power Standard

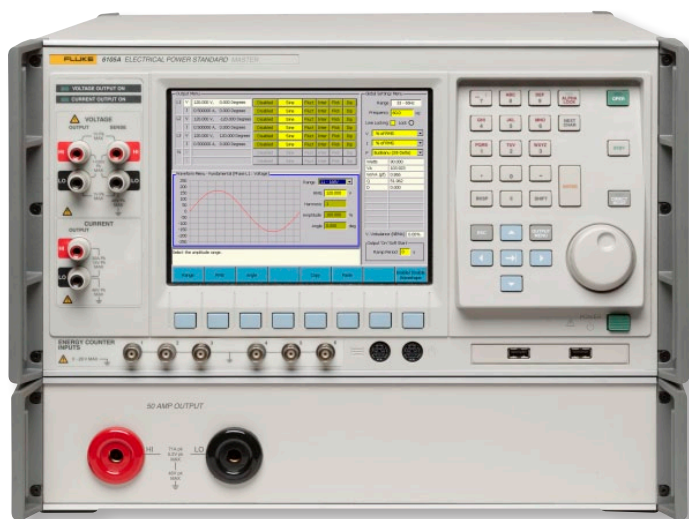

6105A/E/50A Electrical Power Standard

Complex measurements cont.

6100B current waveforms captured using Fluke A40B AC current shunts and a Tektronix oscilloscope.

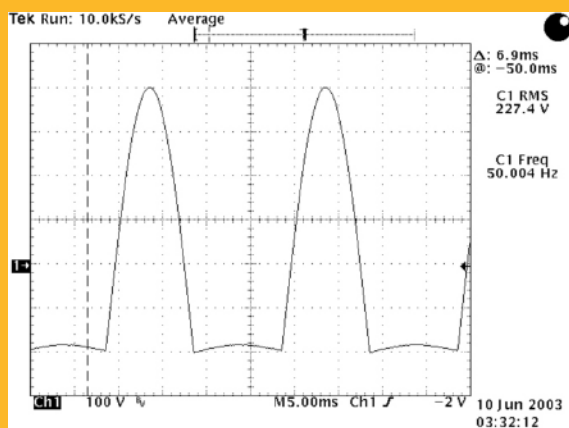

Half-wave rectified waveform

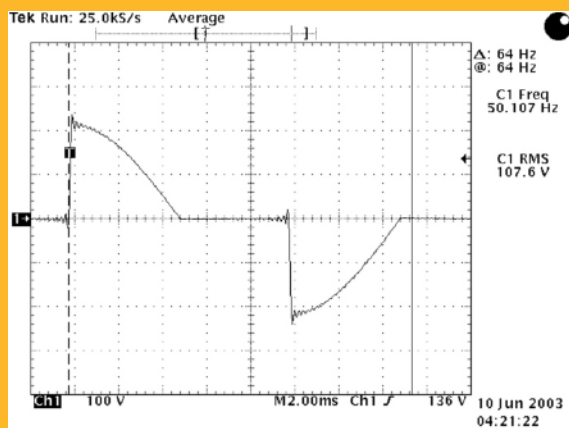

Phase-fired waveform

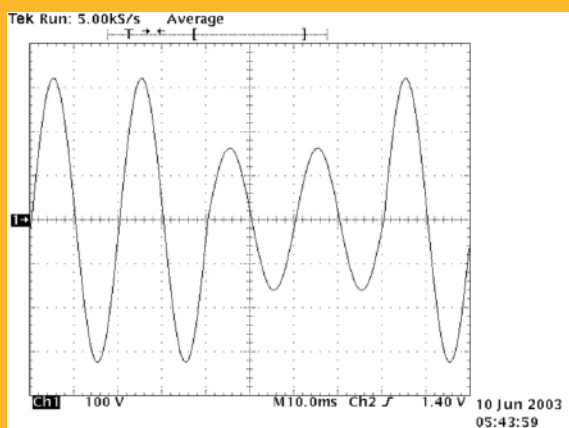

Burst fire waveform

CLK Option

The CLK option is an additional reference signal available from the rear panel. See Reference signals below.

Reference signals

It is not unusual for systems to be synchronized by a common clock signal, particularly when sampling techniques are used. The Fluke 6105A and 6100B provide the following signals:

- **The phase reference:** a CMOS logic signal with rising edge coincident with the positive going zero crossing of the fundamental voltage.
- **Sample reference:** a CMOS logic signal synchronous with the internal sampling. Can be used to synchronize sampling devices for system calibration.
- **Reference signal output (available only when the 'CLK' option is fitted):** TTL compatible 10 MHz or 20 MHz reference output signal derived from the system master clock.

Soft start

To overcome the inrush current of devices taking power from the voltage signal; the user may select 0 to 10 seconds slow ramp-up of the output.

IEC 61036 and IEC 62053 waveforms

To make it more convenient to type test and calibrate watt hour meters, the waveforms required by the relevant standards are pre-installed in the 6105A and 6100B.

User interface

A Microsoft Windows® user interface makes the 6105A and 6100B easy and simple to operate. The interface can be accessed through a combination of front panel knobs and buttons, or by connecting the user's own mouse and keyboard. Actions are then viewed on the high resolution, eight-inch TFT display. Status information of all four phases is displayed, alongside more detailed information on current parameters being set or adjusted.

Frequency domain and time domain representation of current signal types can be displayed on the screen, so the user can evaluate the effect of control settings before applying the signal to the output terminals. A context sensitive help window at the bottom of the screen guides the operator through instrument setup by providing control information and error messages.

The 6105A and 6100B can be operated under remote control. Where multiphase systems are operated, control of the Auxiliary devices is via the Master unit. The 6105A and 6100B conform to the IEEE 488.1 standard and supplemental standard IEEE 488.2. The programming language complies with the Standard Commands for Programmable Instruments (SCPI).

Complex instrument setups can be saved and recalled within the instrument or saved and recalled from a USB storage device.

The screenshot displays the instrument's software interface, divided into several functional areas:

- Output Menu:** A table for configuring output channels. Each channel (L1, L2, L3, N) has voltage (V) and current (I) settings, along with a 'Disabled' status and waveform type options (Sine, Fluct, Inter, Flick, Dip).
- Global Settings Menu:** Controls for the overall output, including Range (33 - 66Hz), Frequency (60.0 Hz), Line Locking, and various power and quality factor settings (Watts, VA, W/VA, Q, D).
- Waveform Menu - Fundamental [Phase L1 : Voltage]:** A graph showing a sine wave. Parameters include Range (11 - 168V), RMS (120.000 V), Harmonic (1), Amplitude (100.000 %), and Angle (0.000 deg).
- Bottom Panel:** A navigation bar with buttons for Range, RMS, Angle, Copy, Paste, and Enable/Disable Waveshape.

Summary specifications

6105A and 6106A sinusoidal power accuracy at 45 Hz to 65 Hz; Power Factor 1.0 (ppm)

Current	Power with current at 90 % of range			Power with current at 50 % range		
	Voltage at 62 % to 70 % range		650 V and 1008 V ranges; 70 % to 75 %	Voltage at 7 % to 100 % range		650 V and 1008 V ranges; 70 % to 75 %
	23 V to 90 V ranges	180 V and 360 V ranges		23 V to 90 V ranges	180 V and 360 V ranges	
0 A to 2 A ranges	62	64	64	72	74	74
5 A to 50 A ranges	65	66	66	74	75	75
80 A range	147	148	148	181	181	181

6105A and 6106A sinusoidal power accuracy at 45 Hz to 65 Hz; Power Factor 0.5 (ppm)

Current	Power with current at 90 % of range			Power with current at 50 % range		
	Voltage at 62 % to 70 % range		650 V and 1008 V ranges; 70 % to 75 %	Voltage at 7 % to 100 % range		650 V and 1008 V ranges; 70 % to 75 %
	23 V to 90 V ranges	180 V and 360 V ranges		23 V to 90 V ranges	180 V and 360 V ranges	
0 A to 5 A ranges	93	94	94	100	101	101
10 A to 50 A ranges	95	96	96	102	102	102
80 A range	163	163	163	194	194	194

6100B and 6101B sinusoidal power accuracy at 45 Hz to 65 Hz; Power Factor 1.0 (ppm)

Current	Power with current at 90 % of range		Power with current at 50 % range	
	23 V to 360 V ranges; 62 % to 70 % range	1008 V range; 740 V to 850 V	23 V to 360 V ranges; 62 % to 70 % range	1008 V range; 740 V to 850 V
0 A to 2 A ranges	236	239	252	239
5 A to 50 A ranges	236	239	252	239
80 A range	322	339	404	417

6100B and 6101B sinusoidal power accuracy at 45 Hz to 65 Hz; Power Factor 0.5 (ppm)

Current	Power with current at 90 % of range		Power with current at 50 % range	
	23 V to 360 V ranges; 62 % to 70 % range	1008 V range; 740 V to 850 V	23 V to 360 V ranges; 62 % to 70 % range	1008 V range; 740 V to 850 V
0 A to 5 A ranges	246	249	262	249
10 A to 50 A ranges	246	249	262	249
80 A range	329	346	409	423

Example 6105A and 6106A non-sinusoidal power accuracy with 20 % THD at Power Factor 1.0 (ppm). Accuracy depends on harmonic order and amplitudes.

Current	Power with current at 90 % of range			Power with current at 50 % range		
	Voltage at 62 % to 70 % range		650 V and 1008 V ranges; 70 % to 75 %	Voltage at 7 % to 100 % range		650 V and 1008 V ranges; 70 % to 75 %
	23 V to 90 V ranges	180 V and 360 V ranges		23 V to 90 V ranges	180 V and 360 V ranges	
0 A to 5 A ranges	97	98	98	103	105	105
10 A to 50 A ranges	98	99	99	105	105	105
80 A range	165	165	165	196	196	196

Example 6100B and 6101B non-sinusoidal power accuracy with 20 % THD at Power Factor 1.0 (ppm). Accuracy depends on harmonic order and amplitudes.

V Range	Power with current at 90 % of range		Power with current at 50 % range	
Current (80 % to 100 % range)	23 V to 360 V ranges; 62 % to 70 % range	1008 V range; 740 V to 850 V	23 V to 360 V ranges; 62 % to 70 % range	1008 V range; 740 V to 850 V
0 A to 5 A ranges	242	255	258	255
10 A to 50 A ranges	242	255	258	255
80 A range	326	350	408	426

For energy specification add 1 ppm.

Summary specifications cont.

Current to voltage phase angle accuracy			
Frequency	Voltage and current components >40 % of range		
	6105A and 6106A 1-Year Accuracy, tcal ±5 °C	6100B and 6101B 1-Year Accuracy, tcal ±5 °C	Stability per hour
45 Hz to 65 Hz	0.0023 °	0.003 °	0.0002 °
16 Hz to 69 Hz	0.003 °	0.003 °	0.0002 °
69 Hz to 180 Hz	0.007 °	0.009 °	0.0002 °
180 Hz to 450 Hz	0.018 °	0.023 °	0.0005 °
450 Hz to 850 Hz	0.033 °	0.043 °	0.0008 °
850 Hz to 3 kHz	0.115 °	0.150 °	0.001 °
3 kHz to 6 kHz	0.230 °	0.300 °	0.001 °

Voltage to voltage phase angle accuracy (poly phase systems)			
Frequency	Voltage components >40 % of range		
	6105A and 6106A 1-Year Accuracy, tcal ±5 °C	6100b and 6101B 1-Year Accuracy, tcal ±5 °C	Stability per hour
16 Hz to 69 Hz	0.005 °	0.005 °	0.0002 °
69 Hz to 180 Hz	0.007 °	0.007 °	0.0002 °
180 Hz to 450 Hz	0.025 °	0.025 °	0.0005 °
450 Hz to 850 Hz	0.043 °	0.050 °	0.0008 °
850 Hz to 3 kHz	0.150 °	0.170 °	0.0010 °
3 kHz to 6 kHz	0.300 °	0.350 °	0.0015 °

Primary electrical specifications	
Voltage/current amplitude setting resolution	6 digits
Range of fundamental frequencies	16 Hz to 850 Hz
Line frequency locking	45 Hz to 65.9 Hz at users discretion
Frequency accuracy	10 ppm
Frequency setting resolution	0.1 Hz
Warm up time to full accuracy	1 hour or twice the time since last warmed up
Output ramp up setting range (soft start)	0 to 10 seconds
Settling time following change to the output	Soft Start setting plus 1.4 second
Nominal angle between voltage phases	120 °
Nominal angle between voltage and current of a phase	0 °
Phase angle setting	±180 °, π radians
Phase angle setting resolution	0.001 °, 0.00001 radians
Maximum number of voltage harmonics	100 including the 1st (fundamental frequency)
Maximum number of current harmonics	100 including the 1st (fundamental frequency)

Sinusoidal and Rectangular Modulation Flicker	
Setting range	± 30 % of set value within range values (60 % ΔV/V)
Flicker modulation depth accuracy	0.025 %
Modulation depth setting resolution	0.001 %
Modulation shape	Sine, rectangular or square
Duty cycle (shape = rectangular)	0.01 % to 99.99 %
Modulating units either: Frequency Changes per minute	0.5 Hz to 40 Hz 1 cpm to 4800 cpm
Modulation frequency accuracy	<0.13 % (1 cpm to 4800 cpm)
Pst Inication accuracy	0.25 %

Other Flicker modes
Frequency changes
Distorted voltage with multiple crossings
Harmonics with side band
Phase jumps
Rectangular voltage changes with duty ratio

Notes as single source spec.

Summary specifications, for energy specification add 1 ppm

Dips and Swells	
Dip/Swell minimum duration	1 ms
Dip/Swell maximum duration	1 minute
Dip minimum amplitude	0 % of the nominal output
Swell maximum amplitude	The least of full range value and 140 % of the nominal output
Ramp up/down period	Settable 100 μ s to 30 seconds
Optional repeat with delay	0 to 60 seconds \pm 31 μ s
Starting level amplitude accuracy	\pm 0.025 % of level
Dip/Swell level amplitude accuracy	\pm 0.25 % of level
Trigger out	TTL falling edge co-incident with end of trigger out delay, remaining low for 10 μ s to 31 μ s

Voltage ranges, maximum burden 50 VA						
23 V	45 V	90 V	180 V	360 V	650 V	1008 V

Sinusoidal voltage					
Frequency	Voltage	6105A and 6106A 1-Year Accuracy, TCal \pm 5 °C (ppm of output + ppm range)		6100B and 6101B 1-Year Accuracy, TCal \pm 5 °C (ppm of output + ppm range)	
		ppm	ppmR	ppm	ppmR
45 Hz to 65 Hz	\pm 5 % Vcal	42	0	112	24
	0 % to 100 % range	42	9	112	24
16 Hz to 850 Hz	0 % to 100 % range	60	9	112	24

Non-sinusoidal voltage					
Output	Frequency	6105A and 6106A 1-Year Accuracy, TCal \pm 5 °C (ppm of output + ppm range)		6100B and 6101B 1-Year Accuracy, TCal \pm 5 °C (ppm of output + ppm range)	
		ppm	ppmR	ppm	ppmR
0 % to 50 % range	DC	92	90	122	140
0 % to 30 % range	16 Hz to 850 Hz	58	24	122	24
	850 Hz to 6 kHz	451	24	512	24

Current ranges										
Full Range (FR)	0.25 A	0.5 A	1 A	2 A	5 A	10 A	21 A	50 A	80 A	
Maximum compliance voltage (Vrms)	10 V	10 V	10 V	10 V	10 V	10 V	8.5 V	3 V	2 V	

Sinusoidal current					
Frequency	Current percent of range	6105A and 6106A 1-Year Accuracy, tcal \pm 5 °C \pm (ppm of output + ppm Range)		6100B and 6101B 1-Year Accuracy, tcal \pm 5 °C \pm (ppm of output + ppm Range)	
		ppm	ppmR	ppm	ppmR
45 Hz to 65 Hz	90 %	47	0	130	24
	0 % to 100 %	47	10	139	24
16 Hz to 850 Hz	10 % to 40 %	61	20	130	24
	40 % to 100 %	61	20	139	24

Non-sinusoidal current					
Frequency	Current percent of range	6105A and 6106A 1-Year Accuracy, tcal \pm 5 °C \pm (ppm of output + ppm Range)		6100B and 6101B 1-Year Accuracy, tcal \pm 5 °C \pm (ppm of output + ppm Range)	
		ppm	ppmR	ppm	ppmR
DC	0 % to 50 %	89	100	191	300
16 Hz to 850 Hz	0 % to 30 %	61	20	139	24
850 Hz to 6 kHz	0 % to 30 %	401	20	400	24

Summary specifications cont.

Voltage from the current terminals			
Full range (FR)	0.25 V	1.5 V	10 V
Max peak	0.353 V	2.121 V	14.14 V
Source impedance	1 Ω	6.67 Ω	40.02 Ω
Minimum load impedance to maintain specification	40 kΩ	260 kΩ	1.5 MΩ

Sinusoidal voltage from the current terminals						
Range	Frequency	Output Component	6105A and 6106A 1-Year Accuracy, tcal ± 5 °C ± (ppm of output + μV)		6100B and 6101B 1-Year Accuracy, tcal ^[4] ± 5 °C ± (ppm of output + μV) ^[5]	
			0.05 V to 0.25 V	45 Hz to 65 Hz	0.1 V to 0.25 V	73
	16 Hz to 850 Hz	0.05 V to 0.25 V	82	10	200	10
0.15 V to 1.5 V	45 Hz to 65 Hz	0.6 V to 1.5 V	53	50	200	50
	16 Hz to 850 Hz	0.6 V to 1.5 V	66	50	200	50
1 V to 10 V	45 Hz to 65 Hz	4 V to 10 V	52	200	200	200
	16 Hz to 850 Hz	4 V to 10 V	66	200	200	200

Input power	
Voltage	100 V to 240 V with up to ± 10 % fluctuations
Frequency	47 Hz to 63 Hz

Environment	
Operating temperature	5 °C to 35 °C
Calibration temperature (tcal) range	16 °C to 30 °C
Storage temperature	0 °C to 50 °C
Warm up time	1 hour

Dimensions		
	6100B, 6101B, 6105A and 6106A	With 50A or 80A options
Height	233 mm (9.17 in)	324 mm (12.8 in)
Height (without feet)	219 mm (8.6 in)	310 mm (12.2 in)
Width	432 mm (17 in)	432 mm (17 in)
Depth	630 mm (24.8 in)	630 mm (24.8 in)
Weight	23 kg (51 lb)	30 kg (66 lb)

Total solutions in calibration

Fluke Calibration provides the broadest range of calibrators and standards, software, service, support and training in electrical, temperature, pressure and flow calibration. Visit www.fluke.com/fpmcat for more information about Fluke Calibration solutions.

Pressure and flow calibration

- High performance pressure and gas flow standards
- Accredited pressure and gas flow calibration services
- Calibration process software
- Services and training



Electrical calibration

- DC/LF electrical calibration
- Power calibration
- Time and frequency
- RF calibration
- Calibration software
- Services and training



Temperature calibration

- Temperature and humidity calibration
- Calibration software
- Services and training



Ordering information

6105A model numbers				
	Number of phases			
Options	1	2	3	4
Auxiliary unit	6106A			
Auxiliary unit + 50A	6106A/50A			
Auxiliary unit + 80A	6106A/80A			
Standard	6105A	6125A	6135A	6145A
50A	6105A/50A	6125A/50A	6135A/50A	6145A/50A
80A	6105A/80A	6125A/80A	6135A/80A	6145A/80A
Energy	6105A/E	6125A/E	6135A/E	6145A/E
CLK	6105A/CLK	6125A/CLK	6135A/CLK	6145A/CLK
50A + CLK	6105A/50A/CLK	6125A/50A/CLK	6135A/50A/CLK	6145A/50A/CLK
80A + CLK	6105A/80A/CLK	6125A/80A/CLK	6135A/80A/CLK	6145A/80A/CLK
Energy + CLK	6105A/E/CLK	6125A/E/CLK	6135A/E/CLK	6145A/E/CLK
Energy + 50A	6105A/E/50A	6125A/E/50A	6135A/E/50A	6145A/E/50A
Energy + 50A + CLK	6105A/50A/E/CLK	6125A/50A/E/CLK	6135A/50A/E/CLK	6145A/50A/E/CLK
Energy + 80A	6105A/E/80A	6125A/E/80A	6135A/E/80A	6145A/E/80A
Energy + 80A + CLK	6105A/80A/E/CLK	6125A/80A/E/CLK	6135A/80A/E/CLK	6145A/80A/E/CLK

6100B model numbers				
	Number of phases			
Options	1	2	3	4
Auxiliary unit	6101B			
Auxiliary unit + 50A	6101B/50A			
Auxiliary unit + 80A	6101B/80A			
Standard	6100B	6120B	6130B	6140B
50A	6100B/50A	6120B/50A	6130B/50A	6140B/50A
80A	6100B/80A	6120B/80A	6130B/80A	6140B/80A
Energy	6100B/E	6120B/E	6130B/E	6140B/E
CLK	6100B/CLK	6120B/CLK	6130B/CLK	6140B/CLK
50A + CLK	6100B/50A/CLK	6120B/50A/CLK	6130B/50A/CLK	6140B/50A/CLK
80A + CLK	6100B/80A/CLK	6120B/80A/CLK	6130B/80A/CLK	6140B/80A/CLK
Energy + CLK	6100B/E/CLK	6120B/E/CLK	6130B/E/CLK	6140B/E/CLK
Energy + 50A	6100B/E/50A	6120B/E/50A	6130B/E/50A	6140B/E/50A
Energy + 50A + CLK	6100B/50A/E/CLK	6120B/50A/E/CLK	6130B/50A/E/CLK	6140B/50A/E/CLK
Energy + 80A	6100B/E/80A	6120B/E/80A	6130B/E/80A	6140B/E/80A
Energy + 80A + CLK	6100B/80A/E/CLK	6120B/80A/E/CLK	6130B/80A/E/CLK	6140B/80A/E/CLK

Accessories	
6100/CASE	6100A/6101A Transit case
6100/CASE/80	6100A/6101A Transit case with 80A Option
Y6100	6100A/6101A Rack Mount Kit
6100-RMK	Rack Mount Ears only
6100/LEAD	Spare Lead set
6100RM-1H/V	Energy Optical Sensor
6100RM-DS/SM	Energy Disc Sensor

Fluke Calibration. Precision, performance, confidence.™

Electrical	RF	Temperature	Pressure	Flow	Software
------------	----	-------------	----------	------	----------

Fluke Calibration
PO Box 9090,
Everett, WA 98206 U.S.A.

Fluke Europe B.V.
PO Box 1186, 5602 BD
Eindhoven, The Netherlands

For more information call:

In the U.S.A. (877) 355-3225 or Fax (425) 446-5116
In Europe/M-East/Africa +31 (0) 40 2675 200 or Fax +31 (0) 40 2675 222
In Canada (800)-36-FLUKE or Fax (905) 890-6866
From other countries +1 (425) 446-5500 or Fax +1 (425) 446-5116
Web access: <http://www.fluke.com>

©2003-2011 Fluke Corporation. Specifications subject to change without notice.
Printed in U.S.A. 2/2011 1779013G D-EN-N Pub-ID 11566-eng Rev 03

Modification of this document is not permitted without written permission from Fluke Corporation.



Via Acquanera, 29 22100 COMO
tel. 031.526.566 (r.a.) fax 031.507.984
info@calpower.it www.calpower.it