

# **5700ANV3**

Multi-Function Calibrator

## Operators Manual

Limited permission for the U.S. Government, its contractors and representatives to reproduce this item is provided pursuant to FAR 52.227.14 Alt. II.

December 2007

© 2007 Fluke Corporation, All rights reserved. Product specifications are subject to change without notice.  
All product names are trademarks of their respective companies.

## LIMITED WARRANTY & LIMITATION OF LIABILITY

Each Fluke product is warranted to be free from defects in material and workmanship under normal use and service. The warranty period is one year and begins on the date of shipment. Parts, product repairs and services are warranted for 90 days. This warranty extends only to the original buyer or end-user customer of a Fluke authorized reseller, and does not apply to fuses, disposable batteries or to any product which, in Fluke's opinion, has been misused, altered, neglected or damaged by accident or abnormal conditions of operation or handling. Fluke warrants that software will operate substantially in accordance with its functional specifications for 90 days and that it has been properly recorded on non-defective media. Fluke does not warrant that software will be error free or operate without interruption.

Fluke authorized resellers shall extend this warranty on new and unused products to end-user customers only but have no authority to extend a greater or different warranty on behalf of Fluke. Warranty support is available if product is purchased through a Fluke authorized sales outlet or Buyer has paid the applicable international price. Fluke reserves the right to invoice Buyer for importation costs of repair/replacement parts when product purchased in one country is submitted for repair in another country.

Fluke's warranty obligation is limited, at Fluke's option, to refund of the purchase price, free of charge repair, or replacement of a defective product which is returned to a Fluke authorized service center within the warranty period.

To obtain warranty service, contact your nearest Fluke authorized service center or send the product, with a description of the difficulty, postage and insurance prepaid (FOB Destination), to the nearest Fluke authorized service center. Fluke assumes no risk for damage in transit. Following warranty repair, the product will be returned to Buyer, transportation prepaid (FOB Destination). If Fluke determines that the failure was caused by misuse, alteration, accident or abnormal condition of operation or handling, Fluke will provide an estimate of repair costs and obtain authorization before commencing the work. Following repair, the product will be returned to the Buyer transportation prepaid and the Buyer will be billed for the repair and return transportation charges (FOB Shipping Point).

THIS WARRANTY IS BUYER'S SOLE AND EXCLUSIVE REMEDY AND IS IN LIEU OF ALL OTHER WARRANTIES, EXPRESS OR IMPLIED, INCLUDING BUT NOT LIMITED TO ANY IMPLIED WARRANTY OF MERCHANTABILITY OR FITNESS FOR A PARTICULAR PURPOSE. FLUKE SHALL NOT BE LIABLE FOR ANY SPECIAL, INDIRECT, INCIDENTAL OR CONSEQUENTIAL DAMAGES OR LOSSES, INCLUDING LOSS OF DATA, WHETHER ARISING FROM BREACH OF WARRANTY OR BASED ON CONTRACT, TORT, RELIANCE OR ANY OTHER THEORY.

Since some countries or states do not allow limitation of the term of an implied warranty, or exclusion or limitation of incidental or consequential damages, the limitations and exclusions of this warranty may not apply to every buyer. If any provision of this Warranty is held invalid or unenforceable by a court of competent jurisdiction, such holding will not affect the validity or enforceability of any other provision.

Fluke Corporation  
P.O. Box 9090  
Everett, WA 98206-9090  
U.S.A.

Fluke Europe B.V.  
P.O. Box 1186  
5602 BD Eindhoven  
The Netherlands

## **Claims**

Immediately upon arrival, purchaser shall check the packing container against the enclosed packing list and shall, within thirty (30) days of arrival, give Fluke notice of shortages or any nonconformity with the terms of the order. If purchaser fails to give notice, the delivery shall be deemed to conform with the terms of the order.

The purchaser assumes all risk of loss or damage to instruments upon delivery by Fluke to the carrier. If an instrument is damaged in transit, **PURCHASER MUST FILE ALL CLAIMS FOR DAMAGE WITH THE CARRIER** to obtain compensation. Upon request by purchaser, Fluke will submit an estimate of the cost to repair shipment damage.

Fluke will be happy to answer all questions to enhance the use of this instrument. Please address your requests or correspondence to: Fluke Corporation, P.O. Box 9090, Everett, WA 98206-9090.

## **Declaration of the Manufacturer or Importer**

We hereby certify that the Fluke Models 5700A Series II and 5720A Series II are in compliance with Postal Regulation Vfg. 1046 and is RFI suppressed. The marketing and sale of the equipment was reported to the German Postal Service. The right to retest this equipment to verify compliance with the regulation was given to the German Postal Service.

## **Bescheinigung des Herstellers/Importeurs**

Hiermit wird bescheinigt, daß Fluke Models 5700A Series II und 5720A Series II in Übereinstimmung mit den Bestimmungen der Amtsblattverfügung Vfg. 1046 funk-entstört ist, Der Deutschen Bundespost wurde das Inverkehrbringen dieses Gerätes angezeigt und die Berechtigung zur Überprüfung der Seire auf Einhaltung der Bestimmungen eingeräumt.

Fluke Corporation

## **Interference Information**

This equipment generates and uses radio frequency energy and if not installed and used in strict accordance with the manufacturer's instructions, may cause interference to radio and television reception. It has been type tested and found to comply with the limits for a Class B computing device in accordance with the specifications in Subpart J of Part 15 of FCC Rules, which are designed to provide reasonable protection against such interference in a residential installation. However, there is no guarantee that interference will not occur in a particular installation. If this equipment does cause interference to radio or television reception, which can be determined by turning the equipment off and on, the user is encouraged to try to correct the interference by one of more of the following measures:

- Reorient the receiving antenna
- Relocate the equipment with respect to the receiver
- Move the equipment away from the receiver
- Plug the equipment into a different outlet so that the computer and receiver are on different branch circuits

If necessary, the user should consult the dealer or an experienced radio/television technician for additional suggestions. The user may find the following booklet prepared by the Federal Communications Commission helpful: How to Identify and Resolve Radio-TV Interference Problems. This booklet is available from the U.S. Government Printing Office, Washington, D.C. 20402. Stock No. 004-000-00345-4.



# OPERATOR SAFETY SUMMARY

## WARNING



## HIGH VOLTAGE

is used in the operation of this equipment

## LETHAL VOLTAGE

may be present on the terminals, observe all safety precautions!

**To avoid electrical shock hazard, the operator should not electrically contact the output hi or sense hi binding posts. During operation, lethal voltages of up to 1100V ac or dc may be present on these terminals.**

**Whenever the nature of the operation permits, keep one hand away from equipment to reduce the hazard of current flowing through vital organs of the body.**




### Terms in this Manual

This instrument has been designed and tested in accordance with the safety standards listed in the General Specifications, which are located in the Specifications section in Chapter 1 of this Operator Manual. This manual contains information and warnings which have to be followed by the user to ensure safe operation and to retain the instrument in safe condition.

WARNING statements identify conditions or practices that could result in personal injury or loss of life.

CAUTION statements identify conditions or practices that could result in damage to the equipment or other property.

## Symbols Marked on Equipment

-  DANGER — High Voltage
-  Protective ground (earth) terminal
-  Attention — refer to the manual. This symbol indicates that information about the usage of a feature is contained in the manual.

## Power Source

The 5700A Series II and 5720A Series II are intended to operate from a power source that will not apply more than 264V ac rms between the supply conductors or between either supply conductor and ground. A protective ground connection by way of the grounding conductor in the power cord is essential for safe operation.

## Use the Proper Fuse

To avoid fire hazard, use only the fuse specified on the line voltage selection switch label, and which is identical in type voltage rating, and current rating.

## Grounding the 5700A Series II or 5720A Series II

The 5700A Series II and 5720A Series II are Safety Class I (grounded enclosure) instruments as defined in IEC 348. The enclosure is grounded through the grounding conductor of the power cord. To avoid electrical shock, plug the power cord into a properly wired earth grounded receptacle before connecting anything to any of the 5700A Series II or 5720A Series II terminals. A protective ground connection by way of the grounding conductor in the power cord is essential for safe operation.

## Use the Proper Power Cord

Always use the power (line) cord and connector appropriate for the voltage and outlet of the country or location in which you are working.

Always match the line cord to the instrument.

- Use the AC line cord supplied with this instrument with this instrument only.
- Do not use this line cord with any other instruments.
- Do not use any other line cords with this instrument.

Use only the power cord and connector appropriate for proper operation of a 5700A Series II or 5720A Series II in your country.

Use only a power cord that is in good condition.

For detailed information on power cords, refer to Figure 2-3 in Chapter 2.

Refer cord and connector changes to qualified service personnel.

## Do Not Operate in Explosive Atmospheres

To avoid explosion, do not operate the 5700A Series II or 5720A Series II in an atmosphere of explosive gas.

## Do Not Remove Cover

To avoid personal injury, do not remove the cover from the 5700A Series II or 5720A Series II. Do not operate the 5700A Series II or 5720A Series II without the cover properly installed. There are no user-serviceable parts inside the 5700A Series II or the 5720A Series II, so there is no need for the operator to ever remove the cover.



# FIRST AID FOR ELECTRIC SHOCK

## **Free the Victim From the Live Conductor**

Shut off high voltage at once and ground the circuit. If high voltage cannot be turned off quickly, ground the circuit.

## **Get Help!**

Call loudly for help. Call an emergency number. Request medical assistance.

## **Never Accept Ordinary and General Tests for Death**

Symptoms of electric shock may include unconsciousness, failure to breathe, absence of pulse, pallor, and stiffness, and well as severe burns.

## **Treat the Victim**

If the victim is not breathing, begin CPR or mouth-to-mouth resuscitation if you are certified.



# Table of Contents

Chapter	Title	Page
<b>1</b>	<b>Introduction and Specifications.....</b>	<b>1-1</b>
1-1.	Introduction.....	1-3
1-2.	Instruction Manuals .....	1-4
1-3.	About this Manual .....	1-4
1-4.	How to Use this Manual .....	1-5
1-5.	Wideband AC Voltage Module (Option 5700A-03) .....	1-5
1-6.	Auxiliary Amplifier .....	1-5
1-7.	5725A Amplifier .....	1-6
1-8.	Support Equipment and Services .....	1-6
1-9.	732B Direct Voltage Reference Standard .....	1-6
1-10.	732B-200 Direct Volt Maintenance Program (U.S.A. Only) .....	1-7
1-11.	742A Series Resistance Standards.....	1-7
1-12.	Wideband AC Module (Option 5700A-03) Calibration Support .....	1-7
1-13.	Service Centers.....	1-7
1-14.	The Components of the 5700A/5720A Series II Calibrator .....	1-8
1-15.	Calibrating the 5700A/5720A Series II Calibrator .....	1-8
1-16.	The Calibration Process.....	1-10
1-17.	Establishing Traceability .....	1-10
1-18.	Calibration Reports.....	1-10
1-19.	Calibration Check .....	1-11
1-20.	Developing a Performance History.....	1-11
1-21.	Range Calibration .....	1-11
1-22.	DC Zeros Calibration.....	1-11
1-23.	Specifications.....	1-12
1-24.	Specification Confidence Levels.....	1-12
1-25.	Using Absolute and Relative Uncertainty Specifications.....	1-12
1-26.	Using Secondary Performance Specifications.....	1-12
1-27.	General Specifications .....	1-13
1-28.	Electrical Specifications .....	1-15
1-29.	DC Voltage Specifications .....	1-15
1-30.	AC Voltage Specifications .....	1-18

1-31.	Resistance Specifications .....	1-29
1-32.	DC Current Specifications.....	1-33
1-33.	AC Current Specifications.....	1-36
1-34.	Wideband AC Voltage (Option 5700-03) Specifications.....	1-42
1-35.	Auxiliary Amplifier Specifications .....	1-43
<b>2</b>	<b>Installation .....</b>	<b>2-1</b>
2-1.	Introduction.....	2-3
2-2.	Unpacking and Inspection .....	2-3
2-3.	Service Information .....	2-4
2-4.	Contacting Fluke.....	2-4
2-5.	Placement and Rack Mounting .....	2-4
2-6.	Cooling Considerations.....	2-4
2-7.	Accessing the Fuse.....	2-5
2-8.	Selecting Line Voltage.....	2-6
2-9.	Connecting to Line Power .....	2-8
2-10.	Connecting a 5725A Amplifier.....	2-8
2-11.	Selecting Output Binding Posts .....	2-8
<b>3</b>	<b>Features .....</b>	<b>3-1</b>
3-1.	Introduction.....	3-3
3-2.	Front Panel Features .....	3-3
3-3.	Display Screen Saver.....	3-3
3-4.	Rear Panel Features .....	3-12
3-5.	Softkey Menu Tree .....	3-14
<b>4</b>	<b>Front Panel Operation.....</b>	<b>4-1</b>
4-1.	Introduction.....	4-3
4-2.	Powering on the Calibrator .....	4-4
4-3.	Warm Up.....	4-4
4-4.	DC Zeros.....	4-5
4-5.	Executing DC Zeros .....	4-5
4-6.	DC Zeros Reminder.....	4-5
4-7.	The Setup Menu.....	4-6
4-8.	Instrument Setup.....	4-7
4-9.	Format EEPROM Menu .....	4-7
4-10.	Spec Format Setup Menu .....	4-8
4-11.	Setting the Internal Clock/Calendar .....	4-9
4-12.	Selecting Amplifiers.....	4-10
4-13.	Checking the Instrument Configuration .....	4-11
4-14.	Special Functions Menu .....	4-12
4-15.	Resetting the Calibrator. ....	4-12
4-16.	Operate and Standby Modes .....	4-13
4-17.	Connecting the Calibrator to a UUT .....	4-13
4-18.	Recommended Cable and Connector Types.....	4-13
4-19.	When to Use External Sensing .....	4-14
4-20.	When to Use the External Voltage Guard .....	4-15
4-21.	When to Use the Current Guard .....	4-15
4-22.	Four-Wire Vs. Two-Wire Resistance Connections .....	4-16
4-23.	Cable Connection Instructions .....	4-16
4-24.	Setting the Output .....	4-22
4-25.	DC Voltage Output.....	4-24
4-26.	AC Voltage Output.....	4-25

4-27.	DC Current Output .....	4-27
4-28.	AC Current Output .....	4-28
4-29.	Resistance Output .....	4-30
4-30.	Wideband AC Voltage Output (Option 5700A-03) .....	4-32
4-31.	Variable Phase Output .....	4-34
4-32.	Phase Locking to an External Signal .....	4-35
4-33.	Using an Auxiliary Amplifier .....	4-36
4-34.	5725A Amplifier Output .....	4-37
4-35.	Checking the Calibrator's Uncertainty Specification .....	4-38
4-36.	Error Mode Operation .....	4-38
4-37.	Error Mode Overview .....	4-39
4-38.	Entering Error Mode .....	4-39
4-39.	Exiting Error Mode .....	4-39
4-40.	Using Error Mode .....	4-40
4-41.	Reading the UUT Error: AC and DC Voltage and Current Output .....	4-40
4-42.	Reading the UUT Error: Resistance Output .....	4-41
4-43.	Introduction to Offset, Scale, and Linearity Errors .....	4-42
4-44.	Offset Error .....	4-42
4-45.	Scale Error .....	4-43
4-46.	Linearity Error .....	4-44
4-47.	Combining the Error Types .....	4-44
4-48.	Programming an Offset .....	4-45
4-49.	Programming a Scale Factor .....	4-46
4-50.	Linearity Checking Using Offset and Scale .....	4-47
4-51.	Setting Output Limits .....	4-50
4-52.	Setting Voltage and Current Limits .....	4-50
4-53.	Sample Applications .....	4-51
4-54.	Calibrating Fluke 70 Series Multimeter .....	4-51
4-55.	Cables .....	4-52
4-56.	Guarding .....	4-52
4-57.	Sensing .....	4-52
4-58.	Testing the Meter .....	4-53
4-59.	Calibrating the Meter .....	4-54
4-60.	Calibrating a Fluke Model 8840A Series Digital Multimeter .....	4-56
4-61.	Cables .....	4-56
4-62.	Guarding .....	4-56
4-63.	Sensing .....	4-58
4-64.	Basic Calibration Procedure .....	4-58
4-65.	Calibration Setup Procedure .....	4-58
4-66.	A/D Calibration .....	4-59
4-67.	Offset and Gain Calibration .....	4-60
4-68.	High Frequency AC Calibration .....	4-62
4-69.	Performing A Wideband Flatness Test .....	4-63
<b>5</b>	<b>Remote Operation .....</b>	<b>5-1</b>
5-1.	Introduction .....	5-3
5-2.	Using the IEEE-488 Port for Remote Control .....	5-4
5-3.	IEEE-488 Bus Restrictions .....	5-4
5-4.	Bus Setup Procedure .....	5-4
5-5.	Using the RS-232C Port for Remote Control .....	5-5
5-6.	Serial Remote Control Setup Procedure .....	5-6
5-7.	Exceptions for Serial Remote Control .....	5-7
5-8.	Command Syntax Information .....	5-7
5-9.	Parameter Syntax Rules .....	5-8

5-10.	Extra Space Characters.....	5-9
5-11.	Terminators.....	5-9
5-12.	Incoming Character Processing.....	5-9
5-13.	Response Message Syntax.....	5-10
5-14.	Input Buffer Operation.....	5-10
5-15.	Commands.....	5-10
5-16.	Multiple Commands.....	5-11
5-17.	Coupled Commands.....	5-11
5-18.	Sequential and Overlapped Commands.....	5-12
5-19.	Commands Ignored When Not in Remote.....	5-12
5-20.	Commands that Require the Calibration Switch to be Set.....	5-12
5-21.	Long Term Commands.....	5-12
5-22.	Local-to-Remote State Transitions.....	5-43
5-23.	Checking the Calibrator's Status.....	5-45
5-24.	Serial Poll Status Byte.....	5-47
5-25.	Service Request Line (SRQ).....	5-48
5-26.	Service Request Enable Register.....	5-48
5-27.	Loading the SRE.....	5-48
5-28.	Event Status Register.....	5-49
5-29.	Bit Assignments for the ESR and ESE.....	5-49
5-30.	Reading the ESR and ESE.....	5-50
5-31.	Loading the ESE.....	5-50
5-32.	Instrument Status Register.....	5-51
5-33.	Instrument Status Change Register.....	5-51
5-34.	Instrument Status Change Enable Register.....	5-51
5-35.	Bit Assignments for the ISR, ISCR, and ISCE.....	5-51
5-36.	Reading the ISR, ISCR, or ISCE.....	5-52
5-37.	Loading the ISCE.....	5-52
5-38.	Fault Queue.....	5-53
5-39.	IEEE-488 Interface Configuration.....	5-54
5-40.	Bus Communication Overview.....	5-55
5-41.	Definition: Queries and Commands.....	5-56
5-42.	Functional Elements Of Commands.....	5-56
5-43.	Interface Messages.....	5-58
5-44.	The IEEE-488 Connector.....	5-60
5-45.	Remote Program Examples.....	5-61
5-46.	Printing Main Output Calibration Shift Results.....	5-61
5-47.	Verifying a Meter.....	5-62
5-48.	Remote Calibration.....	5-62
5-49.	DC Zeros.....	5-62
5-50.	Calibration.....	5-63
5-51.	Calibration Check.....	5-64
5-52.	Wideband AC Module (Option 5700A-03) Gain Calibration.....	5-65
5-53.	Using *OPC?, *OPC, and *WAI.....	5-66
5-54.	Writing an SRQ and Fault Handler.....	5-67
5-55.	Emulating a Fluke 5100B or 5200A Calibrator.....	5-68
5-56.	Entering Emulation Mode.....	5-68
5-57.	Exiting Emulation Mode.....	5-69
5-58.	The 5720's Display During Emulation.....	5-69
5-59.	5100B Emulation.....	5-69
5-60.	Local-to-Remote Transitions.....	5-69
5-61.	Current Output Location.....	5-70
5-62.	Differences in the 5700A/5720A Series II and 5100B Ohms Function.....	5-70
5-63.	Ohms Remote Program Modifications for 5100B Emulation.....	5-71

5-64.	5200A Emulation.....	5-72
5-65.	Local-to-Remote Transitions.....	5-72
5-66.	Voltage and Frequency Ranges.....	5-72
5-67.	Rounding Numeric Entries.....	5-73
5-68.	Settling Times.....	5-73
5-69.	Programming External Sensing.....	5-74
5-70.	Overload Conditions.....	5-74
5-71.	Phase Lock Errors.....	5-74
<b>6</b>	<b>Using the RS-232C Serial Interface.....</b>	<b>6-1</b>
6-1.	Introduction.....	6-3
6-2.	RS-232C Interface Specifications.....	6-3
6-3.	Setting Up and Connecting the Serial Interface.....	6-4
6-4.	Printing Calibration Reports.....	6-6
6-5.	Calibration Shift Results.....	6-6
6-6.	Calibration Check Shift Results.....	6-7
6-7.	Generating a Printout.....	6-8
<b>7</b>	<b>Operator Maintenance.....</b>	<b>7-1</b>
7-1.	Introduction.....	7-3
7-2.	Accessing the Fuse.....	7-4
7-3.	Cleaning the Air Filter.....	7-4
7-4.	Cleaning the Exterior.....	7-6
7-5.	Calibration.....	7-6
7-6.	Calibrating the 5700A/5720A Series II to External Standards.....	7-6
7-7.	Calibration Requirements.....	7-7
7-8.	When to Adjust the Calibrator’s Uncertainty.....	7-7
7-9.	Calibration Procedure.....	7-8
7-10.	Range Calibration.....	7-14
7-11.	Calibrating the Wideband AC Module (Option 5700A-03).....	7-18
7-12.	Performing a Calibration Check.....	7-21
<b>8</b>	<b>Options and Accessories.....</b>	<b>8-1</b>
8-1.	Introduction.....	8-3
8-2.	Wideband AC Voltage Module (Option 5700A-03).....	8-3
8-3.	Accessories.....	8-3
8-4.	Low Thermal EMF Test Leads.....	8-4
8-5.	Rack Mount Kits (Y5737 and Y5735).....	8-4
8-6.	Shielded IEEE-488 Interface Cables (Y8021 and Y8022).....	8-4
8-7.	RS-232C Null-Modem Cables.....	8-4
8-8.	DC Voltage Reference Standard (732B).....	8-4
8-9.	1 $\Omega$ and 10 k $\Omega$ Resistance Standards (742A-1 and 742A-10k).....	8-5
8-10.	5725A Amplifier.....	8-5
 <b>Appendices</b>		
	Fault Codes.....	A-1
	ASCII and IEEE Bus Codes.....	B-1
	Symbolic Names of Calibration Constants.....	C-1
	Glossary.....	D-1



# List of Tables

<b>Table</b>	<b>Title</b>	<b>Page</b>
1-1.	Auxiliary Amplifier Data .....	1-6
2-1.	Standard Equipment .....	2-3
2-2.	Line Power Cord Types Available from Fluke .....	2-6
3-1.	Front Panel Features .....	3-4
3-2.	Rear Panel Features .....	3-12
4-1.	Auxiliary Amplifier Data .....	4-14
4-2.	UT Connection Figures .....	4-16
4-3.	Keys that Exit Error Mode .....	4-39
4-4.	8840A A/D Converter Calibration Prompts .....	4-59
4-5.	8840A A/D Calibration Allowable Errors .....	4-60
4-6.	8840A Offset and Gain Calibration Prompts .....	4-61
4-7.	8840A High-Frequency AC Calibration Prompts .....	4-62
5-1.	Command Summary by Function .....	5-13
5-2.	Commands .....	5-17
5-3.	Serial Remote Control Commands .....	5-42
5-4.	Range Identifiers for Remote Commands .....	5-42
5-5.	Operating State Transitions .....	5-44
5-6.	Status Register Summary .....	5-45
5-7.	Supported IEEE-488 Interface Function Subsets .....	5-54
5-8.	Functional Elements of Commands .....	5-57
5-9.	Interface Messages Accepted by the Calibrator .....	5-58
5-10.	Interface Messages Sent by the Calibrator .....	5-59
6-1.	RS-232C Interface Parameter Choices .....	6-4
6-2.	Annotation for Shift Results Printout .....	6-16
7-1.	Standards for Calibrating 5700A/5720A Series II .....	7-7
8-1.	Accessories .....	8-3



# List of Figures

Figure	Title	Page
1-1.	Time and Costs: Calibrator Calibration.....	1-9
2-1.	Accessing the Fuse .....	2-5
2-2.	Line Power Cord Types Available from Fluke .....	2-6
2-3.	Line Power Label and Switch Location .....	2-7
3-1.	Front Panel Features.....	3-5
3-2.	Rear Panel Features.....	3-13
3-3.	Softkey Menu Tree.....	3-16
4-1.	UUT Connections: DC Voltage, AC Voltage $\leq 10$ kHz .....	4-17
4-2.	UUT Connections: AC Voltage $> 10$ kHz .....	4-18
4-3.	UUT Connections: AC Current $\leq 2$ A.....	4-19
4-4.	UUT Connections: Resistance .....	4-20
4-5.	UUT Wideband AC Voltage Output (Option 5700A-03).....	4-22
4-6.	UUT Connections: 5725A Amplified Current Output .....	4-23
4-7.	Offset Error .....	4-42
4-8.	Scale Error.....	4-43
4-9.	Linearity Error.....	4-44
4-10.	Meter Response vs. Stimulus .....	4-47
4-11.	Cable Connections for Testing a Fluke 70 Series Multimeter .....	4-53
4-12.	Cable Connections for Calibrating a Fluke 70 Series Multimeter .....	4-55
4-13.	8840A Calibration Connections .....	4-57
5-1.	Overview of Status Data Structure.....	5-46
5-2.	IEEE-488 Connector Pin Assignments .....	5-60
6-1.	RS-232C Connector Pinout.....	6-3
7-1.	Accessing the Fuse .....	7-4
7-2.	Accessing the Air Filter.....	7-5
7-3.	732B External Calibration Connections.....	7-9
7-5.	220V DC Range Calibration Connections .....	7-17
7-6.	Wideband Module Calibration Connection.....	7-19



# **Chapter 1**

## **Introduction and Specifications**

	<b>Title</b>	<b>Page</b>
1-1.	Introduction.....	1-3
1-2.	Instruction Manuals .....	1-4
1-3.	About this Manual .....	1-4
1-4.	How to Use this Manual .....	1-5
1-5.	Wideband AC Voltage Module (Option 5700A-03) .....	1-5
1-6.	Auxiliary Amplifier .....	1-5
1-7.	5725A Amplifier .....	1-6
1-8.	Support Equipment and Services .....	1-6
1-9.	732B Direct Voltage Reference Standard .....	1-6
1-10.	732B-200 Direct Volt Maintenance Program (U.S.A. Only) .....	1-7
1-11.	742A Series Resistance Standards.....	1-7
1-12.	Wideband AC Module (Option 5700A-03) Calibration Support .....	1-7
1-13.	Service Centers.....	1-7
1-14.	The Components of the 5700A/5720A Series II Calibrator .....	1-8
1-15.	Calibrating the 5700A/5720A Series II Calibrator .....	1-8
1-16.	The Calibration Process.....	1-10
1-17.	Establishing Traceability .....	1-10
1-18.	Calibration Reports.....	1-10
1-19.	Calibration Check .....	1-11
1-20.	Developing a Performance History.....	1-11
1-21.	Range Calibration .....	1-11
1-22.	DC Zeros Calibration.....	1-11
1-23.	Specifications.....	1-12
1-24.	Specification Confidence Levels.....	1-12
1-25.	Using Absolute and Relative Uncertainty Specifications.....	1-12
1-26.	Using Secondary Performance Specifications.....	1-12
1-27.	General Specifications .....	1-13
1-28.	Electrical Specifications .....	1-15
1-29.	DC Voltage Specifications .....	1-15

1-30.	AC Voltage Specifications .....	1-18
1-31.	Resistance Specifications .....	1-29
1-32.	DC Current Specifications.....	1-33
1-33.	AC Current Specifications.....	1-36
1-34.	Wideband AC Voltage (Option 5700-03) Specifications.....	1-42
1-35.	Auxiliary Amplifier Specifications .....	1-43


## 1-1. Introduction

The Fluke Model 5700ANV3 Calibrators are precise instruments that calibrate a wide variety of electrical measuring instruments. In this manual, all references to 5700A apply to 5700ANV3. When ordering replacement parts, please specify 5700ANV3. These calibrators maintain high accuracy over a wide ambient temperature range, allowing them to test instruments in any environment, eliminating the restrictions to calibrate only in a temperature-controlled standards laboratory. With a 5700A/5720A Series II, you can calibrate precision multimeters that measure ac or dc voltage, ac or dc current, and resistance. The 5720A Series II operates in a similar manner to the 5700A Series II, the difference is that the 5720A Series II has a considerably higher specified accuracy. Option 5700A-03 Wideband AC Voltage, which is available for both the 5700A Series II and the 5720A Series II, extends this workload to include rf voltmeters.

Specifications are provided at the end of this chapter. The calibrator is a fully-programmable precision source of the following:

- DC voltage to 1100 V
- AC voltage to 1100 V, with output available from 10 Hz to 1.2 MHz
- AC and DC current to 2.2 A, with output available from 10 Hz to 10 kHz
- Resistance in values of  $1 \times 10^n$  and  $1.9 \times 10^n$  from 1  $\Omega$  to 100 M $\Omega$ , plus a short
- Optional wideband ac voltage from 300  $\mu$ V to 3.5 V into 50  $\Omega$  (-57 dBm to +24 dBm), 10 Hz to 30 MHz

Features of the calibrator include the following:

- Internal environmentally-controlled references allowing the calibrator to maintain full performance over a wide ambient temperature range
- Automatic meter error calculation obtained through using a simple output adjust knob; the display shows linearity, offset, and scale errors
- Keys that multiply and divide the output value by 10 to simplify work on meters with calibration points at decade multiples of a fraction of full-scale
- Programmable entry limits used for restricting the levels that can be keyed into the calibrator, preventing access to levels that may be harmful to equipment or personnel
- A  key that provides the capability of displaying the instrument's specification at the selected operating point, calibration interval, and specification confidence level
- An auxiliary current binding post that allows you to calibrate meters with separate current inputs without moving cables
- Real-time clock and calendar for date stamping reports
- Offset and scaling modes that simplify linearity testing of multimeters
- Variable phase reference signal output and phase-lock input
- Interface for the Fluke 5725A Amplifier
- Standard IEEE-488 (GPIB) interface, complying with ANSI/IEEE Standards 488.1-1987 and 488.2-1987
- Selectable normal remote mode or emulation of the Fluke 5100B and 5200A Series calibrators in functions and response to system controller software
- EIA Standard RS-232C serial data interface for printing, displaying, or transferring internally-stored calibration constants, and for remote control of the calibrator
- Extensive internal self-testing and diagnostics of analog and digital functions

- A traceable calibration procedure for all modes and ranges that requires only 10 V, 1  $\Omega$ , and 10 k $\Omega$  external standards, with only occasional independent verification
- Fast, simple, automated calibration check providing added confidence between calibration recalls, and data that can be used to document and characterize the calibrator's performance between calibration recalls

## **1-2. *Instruction Manuals***

The 5700A/5720A Series II Calibrators ship with a complete manual set that contains information for the operator and service or maintenance technicians. The set includes:

- *5700A/5720A Series II Getting Started Manual* (PN 1668111)
- *5700A/5720A Series II Operator Reference Guide* (PN 601648)
- *5700A/5720A Series II Remote Programming Reference Guide* (PN 601655)
- *5700A/5720A Series II Operator Manual* (provided on CD-ROM, PN 1668127, or a printed copy is available for purchase through the Fluke Service Department under PN 601622)
- *5700A/5720A Series II Service Manual* (provided on CD-ROM, PN 1668127, or a printed copy is available for purchase through the Fluke Service Department under PN 105798)

Order additional copies of these instruction manuals separately using the part numbers provided. For ordering instructions, refer to the Fluke Catalog or contact a Fluke sales representative.

## **1-3. *About this Manual***

This manual provides complete information for installing the calibrator and operating it from the front panel keys and in remote. It also provides a glossary of calibration-related terms as well as general items such as specifications and error code information. The following topics are covered in this manual:

- Installation
- Operating controls and features
- Front panel operation
- Remote operation (IEEE-488 bus or serial port remote control)
- Serial port operation (printing, displaying, or transferring data, and setting up for serial port remote control)
- Operator maintenance, including how to calibrate the 5700A/5720A Series II Calibrator
- Options and accessories

## **1-4. How to Use this Manual**

Use the following list to find the location of specific information.

- Unpacking and setup: Chapter 2
- Installation and rack mounting: Chapter 2; also the rack mount kit instruction sheet
- AC line power and interface cabling: Chapter 2
- Controls, indicators, and displays: Chapter 3
- Front panel operation: Chapter 4
- Cabling to a UUT (Unit Under Test): Chapter 4
- Using auxiliary amplifiers: Chapter 4
- Self calibration: Chapters 1 and 7
- Remote operation (IEEE-488 or serial): Chapter 5
- Options and accessories: Chapters 2 and 8
- Instrument specifications: The end of this Chapter

## **1-5. Wideband AC Voltage Module (Option 5700A-03)**

The Wideband AC Voltage Module (Option 5700A-03) can be installed in both the 5700A and 5720A Series II Calibrators. The module is a high-accuracy, low-noise, extremely flat ac voltage source for calibrating rf voltmeters, with a frequency range of 10 Hz to 30 MHz. Output is in seven ranges from 300  $\mu\text{V}$  (-57 dBm) to 3.5 V (+24 dBm) through a Type-N coaxial connector into a 50  $\Omega$  load. The output level is selected in volts or dBm through either the front panel controls or under remote control.

The wideband module also functions with the calibrator's output adjust controls that let display the error of a wideband meter in either percentage of output or in decibels.

Included with the wideband module is a Type-N output cable and a 50  $\Omega$  terminator. The wideband module is calibrated to the end of its standard-equipment output cable.

## **1-6. Auxiliary Amplifier**

The Fluke Model 5725A Amplifier is available to extend the high voltage performance and current range of the calibrator:

Interface connectors on the calibrator's rear panel accept cables to directly operate a 5725A. Three amplifiers can be connected to the calibrator at the same time, but only one output can be active at a time. Once you have connected the amplifiers and configured the calibrator in a setup menu, amplifier operation is controlled by the calibrator.

Chapter 4 provides instructions for operating the 5725A. The general specifications at the end of this chapter include specifications for operating the calibrator with the 5725A. For other amplifier specifications, refer to their instruction manuals. Table 1-1 summarizes the extended capabilities offered by the 5725A. Brief descriptions of the extended capabilities follow.

Table 1-1. Auxiliary Amplifier Data

Model	Mode	Range
5725A Amplifier	AC V	20 to 1100 V rms up to 70 mA, 40 Hz to 30 kHz (50 mA < 5 kHz)  220 to 750 V rms up to 70 mA, 30 kHz to 100 kHz
	DC Amps	0 to ±11 A
	DC Amps	1 to 11 A rms, 40 Hz to 10 kHz

### 1-7. 5725A Amplifier

The Fluke 5725A Amplifier is an external unit operating under calibrator control to extend ac voltage drive capabilities and both ac and dc current output range. The amplifier adds the following capabilities to the calibrator's 1100 V AC range with no compromise in accuracy:

- Frequency limits at higher voltage increase to 100 kHz at 750 V, 30 kHz at 1100 V.
- Load limit increases to 70 mA for frequencies above 5 kHz.
- Capacitive drive increases to 1000 pF, subject to the maximum output current.

Extended-performance voltage is available at the calibrator's front or rear binding posts, eliminating the need to change cables during a procedure.

A separate set of binding posts on the front panel of the 5725A supplies extended-range ac and dc current outputs. Since most meters have a separate input terminal for the high current ranges, this eliminates the need to change cables during a procedure. The 5725A can also be configured to source all current (both standard calibrator-generated current and its own current) through the 5725A binding posts.

### 1-8. Support Equipment and Services

Fluke supports your calibration needs with precision, high-quality equipment and a wide range of services. Depending on your needs, location, and capabilities, you may decide to support your 5700A/5720A Series II Calibrator independently or use Fluke services for part, or all, of your support needs. The following paragraphs describe the support equipment and services offered by Fluke for the calibrator. For specifications and ordering instructions for this support equipment and other Fluke instruments, refer to the Fluke catalog, or contact a representative at a Fluke Sales and Service Center.

### 1-9. 732B Direct Voltage Reference Standard

The Fluke 732B is a rugged, easily transported solid state direct voltage reference standard with a highly predictable 10 V output. This predictability allows the Fluke Standards Laboratory, as well as many Fluke customers, to completely eliminate fragile, saturated standard cells. Laboratories still maintain standard cells using the 732A and 732B as a transportable voltage standard, eliminating the need to transport their standard cells. The 732B can be short-circuited, even for extended periods of time, without damage or loss of stability. It maintains full specified stability over a temperature span of 18 to 28 °C.

The calibrator uses a 10 V reference standard such as the Fluke 732B in its semi-automated calibration procedure to establish external voltage traceability. Chapter 7 describes this procedure.

### **1-10. 732B-200 Direct Volt Maintenance Program (U.S.A. Only)**

The Fluke 732B-200 Direct Volt Maintenance Program provides your laboratory with NIST-traceable 10 V calibration uncertainty as low as 0.6 parts per million.

The program maintains the 732B that you keep in your laboratory. To accomplish this, the following occurs:

1. Fluke sends you a calibrated Fluke-owned 732B standard, together with all-necessary connecting cables and instructions for comparison with your 10 V reference standard.
2. You take a series of readings over a five-day period, and return the results to the Fluke Standards Laboratory.
3. The Fluke Standards Laboratory assigns a value to your 10 V standard relative to the NIST legal volt and sends you a report of calibration.

### **1-11. 742A Series Resistance Standards**

The calibrator uses 1  $\Omega$  and 10 k $\Omega$  resistor standards such as the 742A Series in its semi-automated calibration procedure to establish external traceability of resistance and current. Chapter 7 describes this procedure.

The 742A Resistance Standards, which are constructed of arrays of Fluke wirewound precision resistors, are ideally suited as support standards for the calibrator. Stability of the resistance transfer standards and their temperature coefficients make them ideal for easy transport to and operation in the calibrator's working environment.

### **1-12. Wideband AC Module (Option 5700A-03) Calibration Support**

The Wideband AC Module (Option 5700A-03) requires two kinds of calibration: gain and flatness. Gain constants are checked and recalibrated as a part of the normal calibrator semi-automated calibration process.

Since frequency flatness is determined by such stable parameters as circuit geometry and dielectric constants, flatness of the Wideband AC module has excellent long-term stability. This stability gives the Wideband AC Module a two-year calibration cycle for flatness calibration. Flatness calibration is required only infrequently, and can be done when the calibrator is returned to a standards laboratory for periodic verification. The *5700A/5720A Series II Service Manual* contains the wideband flatness calibration procedure. Chapter 7 of this manual contains the wideband gain calibration procedure.

### **1-13. Service Centers**

A worldwide network of Fluke service centers supports Fluke instruments and assists customers in many ways. Most service centers have standards and calibration laboratories certified by local national standards organizations. The following is a partial list of the services provided by most service centers:

- Repair and certified traceable calibration of all Fluke products.
- Certified traceable calibration of many non-Fluke standards and calibrators.
- Worldwide exchange of calibrator internal modules. Delivery inside the U.S.A. is typically within 48 hours.
- Service agreements with the flexibility to suit your needs. These can be a simple warranty extension or an agreement that includes on-site support. Calibration service agreements are also available in many areas.

- Training programs and seminars, including laboratory metrology, system applications, and product maintenance.
- Application help and consulting, including system design, hardware selection, custom software, site evaluation and installation.
- Replacement parts inventory, including recommended spare parts and module kits.

Visit **www.fluke.com** for locations and phone numbers of authorized Fluke service centers.

### **1-14. The Components of the 5700A/5720A Series II Calibrator**

The calibrator is configured internally as an automated calibration system, with process controls and consistent procedures. Internal microprocessors control all functions and monitor performance, using a switching matrix to route signals between modules. Complete automatic internal diagnostics, both analog and digital, confirm operational integrity.

Reference amplifiers maintain dc accuracy and stability. Of all technologies available, reference amplifiers have the lowest noise and best stability. Reference amplifiers in the calibrator go through special selection processes including long-term aging to ensure high reliability and performance well within specifications.

The calibrator achieves its exceptional ac voltage accuracy by using a patented Fluke rms sensor to make real-time AC/DC comparison measurements. The Fluke rms sensor is similar in principle to the traditional thermal voltage converter, but has a shorter time constant, virtually no reversal error, higher signal-to-noise ratio, and better frequency response. In the calibrator, one Fluke rms sensor serves as an AC/DC transfer standard to develop gain and flatness correction constants during calibration. The second Fluke rms sensor continuously monitors and corrects output voltage during operation.

A patented 26-bit digital-to-analog converter (dac) provides the calibrator with the ability to precisely vary its output. This is a pulse-width-modulated dac with linearity typically better than 0.2 ppm of full scale. As with the other internal functions, the linearity of the dac is automatically checked during calibration and analog diagnostics.

### **1-15. Calibrating the 5700A/5720A Series II Calibrator**

The traditional practice of returning a calibrator to a standards laboratory at regular intervals for a full calibration is time consuming, expensive, and disruptive to the task to which the calibrator is being applied. Moreover, it leaves gaps in confidence. You must rely on manufacturer's specifications to determine if a calibrator will perform acceptably in an operating environment outside the lab. Also, you must assume that drift is predictable enough so that performance is within limits between recalls.

The 5700A/5720A Series II Calibrator makes use of Fluke design breakthroughs in the use of internal check standards and measurement systems. As a result, it can be completely calibrated in place to full specifications using a small number of convenient, portable, environmentally tolerant standards available from Fluke. As you will see below, this procedure is traceable to military standard requirements.

When manufactured, each calibrator is calibrated and thoroughly verified with process metrology and calibration standards traceable to the U.S. National Bureau of Standards. A certificate of calibration is included.

A calibration verification procedure described in the *5700A/5720A Series II Service Manual* is recommended every two years or as required by your established policies. This

procedure involves no adjustments. It simply ensures internal processes are in control, and establishes parallel external traceability paths for internal functions such as ac transfers that are never adjusted or corrected.

Figure 1-1 illustrates the time and money that can be saved by using the 5700A/5720A Series II calibration support plan recommended by Fluke. Depending on your policies, you may initially decide to perform calibration verification more often. The calibrator makes this unnecessary and offers you a practical way to collect data unavailable with a traditional calibrator design about performance between calibrations.

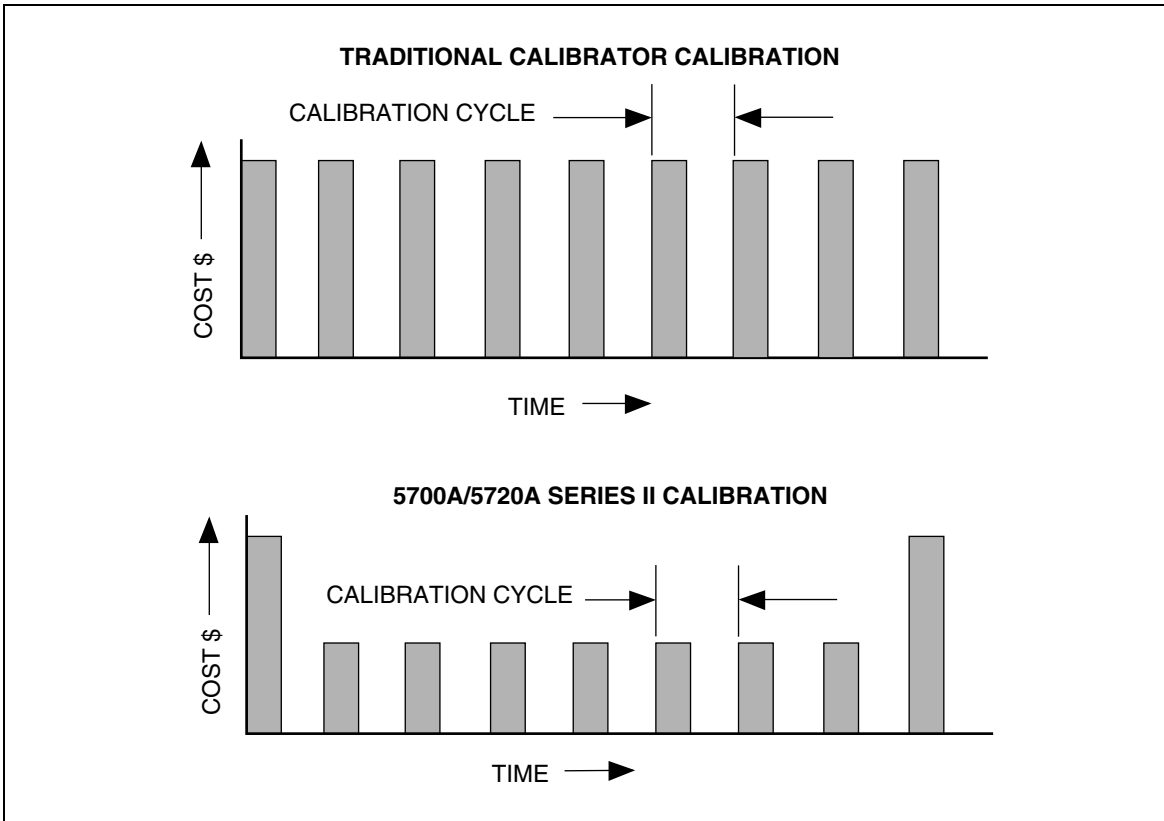


Figure 1-1. Time and Costs: Calibrator Calibration

## 1-16. The Calibration Process

Calibration requires only three external standards: 10 V, 1  $\Omega$ , and 10 k $\Omega$ . Environmentally-controlled internal check standards provide the primary reference points. A stored table of calibration constants defines additional reference points for controlling the output. Traceable calibration and adjustment to the specified level of performance is accomplished in a semi-automated process that revises this table.

When you finish calibration, but before you save the new constants, the calibrator presents you with the proposed adjustments as +/- ppm of range and percentage change in specification for each range and function. You can print a list of changes through the serial (RS-232C) port, or send them to a computer through either the serial port or the IEEE-488 port. Also on completion of calibration, the calibrator displays the largest proposed change.

Calibration can be completed as far as deriving and printing the proposed adjustments without changing the setting of the rear panel CALIBRATION switch; however, the switch must be set to ENABLE to store the changes in nonvolatile memory and make them effective. The switch is recessed to allow the metrologist to cover it with a calibration sticker to guarantee calibrator integrity.

## 1-17. Establishing Traceability

Traceability to national standards is established as follows:

- Except for the internal AC/DC transfer standard, the internal check standards are directly calibrated by traceable external standards every time the 5700A/5720A Series II is calibrated.
- The internal AC/DC transfer standard is never adjusted, so its traceability is not disturbed by calibration. Infrequent verification is done in the traditional way, by comparing selected ac voltage outputs with an external dc voltage standard through an external ac/dc transfer standard. Fluke recommends this is done every two years or as determined by the policy of your organization.
- Infrequent independent verification is also performed on stable parameters, such as frequency flatness, determined more by circuit geometry and dielectric constants than time.

## 1-18. Calibration Reports

The calibrator stores two sets of calibration constants: the set currently in use and the old set from the previous calibration. This gives the calibrator the ability at any time to produce a calibration report of the differences between the present settings and the settings that were in effect before the last calibration. The report shows changes for each range and function in +/- ppm of range and in percentage of specification limit. You can print the report or send it to a host computer through either the RS-232-C or IEEE-488 interface.

If you request a calibration report after doing calibration but before saving the new constants, the report shows proposed changes to the calibration constants relative to the previously stored settings.

## **1-19. Calibration Check**

Checking the calibration takes about an hour, and provides you with a means of documenting the calibrator's performance of a between calibrations. Calibration checking is similar to calibration, except internal check standards are used as primary references (no external standards are needed), and changes cannot be stored. The process produces a report similar to normal calibration, showing drift relative to internal check standards. Because cal check does not change stored calibration constants, there is no need to enable the rear panel CALIBRATION switch. Therefore, an external computer can do the procedure unattended.

## **1-20. Developing a Performance History**

A Fluke specification is a set of performance limits that all products must meet. To maintain consistent quality, Fluke calibrators are specified with enough margin to include temperature, line, and load extremes, plus additional margin for production. This means that a typical 5700A/5720A Series II calibrator in a typical environment operates inside 50 % of specification limits. For some exacting applications, it can be helpful to know just how accurately a particular calibrator operates. The proper way to do this is to accumulate a performance history by calibrating regularly and recording results on a control chart.

Calibrating regularly and recording the results on a control chart is tedious and requires a large array of equipment. The calibrator's calibration check feature is an alternative with some distinct advantages:

- Calibrated check standards are already programmed into the unit. You do not have to use external standards.
- The process is consistent and automatic: it does not require an operator's assistance.

Each calibration check produces a new set of data points for accumulating a historical record. When this process is externally automated, significant history can be accumulated much faster than with a manual calibration.

## **1-21. Range Calibration**

After calibration, you can make further fine adjustments to each range. Range adjustments are optional; they are not necessary to meet total uncertainty specifications. However, they do allow you to align your calibrator closer to your standards.

Before you do range calibration, you must first use the calibrator's semi-automated calibration procedure. This is to calibrate the ranges that will not be adjusted. It also performs an initial adjustment for each range, and supplies flatness corrections for ac functions.

## **1-22. DC Zeros Calibration**

To ensure the validity of the specifications, a dc zeros calibration must be performed at least every 30 days. If more than 30 days elapse without a dc zeros calibration a warning message appears. This procedure does not require any external equipment or connections and takes approximately 2.5 minutes to complete.

### **1-23. Specifications**

The 5700A/5720A Series II Calibrators are verified and calibrated at the factory prior to shipment to ensure they meet the accuracy standards required for all certified calibration laboratories. By calibrating to the specifications in this chapter, you can maintain the high performance level throughout the life of your calibrator.

Specifications are valid after a warm-up period of twice the time the calibrator has been turned off, up to a maximum of 30 minutes. For example, if the calibrator has been turned off for five minutes, the warm-up period is ten minutes.

### **1-24. Specification Confidence Levels**

Your calibrator's performance level is ensured by regular calibration to the primary performance specifications, which are provided at both the 99 % and 95 % confidence levels. The 95 % confidence level will provide an accuracy that will often surpass the accuracy requirements for meeting Tag 4 standards, or a coverage factor of 2. Calibration at the 99 % confidence level is also available for those applications that require a confidence factor for the specifications that is higher than 95 %. For information on selecting the confidence level, refer to Chapter 4.

The tables in this chapter provide specifications at both the 95 % and 99 % confidence levels for the 5700A/5720A Series II Calibrators. Included with these tables are operating specifications for using the calibrator with the Wideband AC Module (Option 5700A-03) and the 5725A Amplifier.

### **1-25. Using Absolute and Relative Uncertainty Specifications**

To evaluate the 5700A/5720A Series II coverage of your calibration workload, use the Absolute Uncertainty specifications. Absolute uncertainty includes stability, temperature coefficient, linearity, line and load regulation, and the traceability to external standards. You do not need to add anything to absolute uncertainty to determine the ratios between the calibrator's uncertainties and the uncertainties of your calibration workload.

Relative uncertainty specifications are provided for enhanced accuracy applications. These specifications apply when range constants are adjusted (see "Range Calibration"). To calculate absolute uncertainty, you must combine the uncertainties of your external standards and techniques with relative uncertainty.

### **1-26. Using Secondary Performance Specifications**

Secondary performance specifications and operating characteristics are included in uncertainty specifications. They are provided for special calibration requirements such as stability or linearity testing.

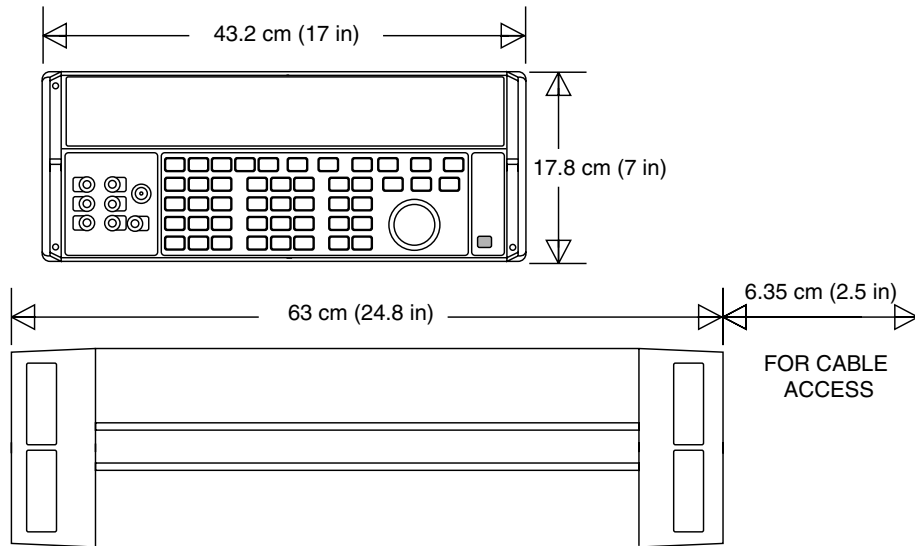
## 1-27. General Specifications

<b>Warm-Up Time</b> .....	Twice the time since last warmed up, to a maximum of 30 minutes.
<b>System Installation</b> .....	Rear output configuration and rack-mount kit available.
<b>Standard Interfaces</b> .....	IEEE-488, RS-232, 5725A, 5205A or 5215A, 5220A, phase lock in (BNC), phase reference out (BNC).
<b>Temperature Performance</b>	
Operating .....	0 °C to 50 °C
Calibration.....	15 °C to 35 °C
Storage .....	-40 °C to 75 °C
<b>Relative Humidity</b>	
Operating .....	<80 % to 30 °C, <70 % to 40 °C, <40 % to 50 °C
Storage .....	<95 %, non-condensing. A power stabilization period of four days may be required after extended storage at high temperature and humidity.
<b>Safety</b> .....	Designed to comply with UL3111; EN61010; CSA C22.2 No. 1010; ANSI/ISA S82.01-1994
<b>Guard Isolation</b> .....	20 V
<b>EMI/RFI</b> .....	Designed to comply with FCC Rules Part 15, Subpart B, Class B; EN50081-1, EN50082-1
<b>ElectroStatic Discharge</b> .....	This instrument meets criteria C for ESD requirements per EN61326
<b>Line Power</b>	
Line Frequency .....	47 to 63 Hz; ±10 % 100 V, 110 V, 115 V, 120 V, 200 V, 220 V, 230 V, 240 V
Maximum Power	
5700A/5720A .....	300 VA
5725A .....	750 VA
<b>Weight</b>	
5700A/5720A .....	27kg (62 lbs)
5725A.....	32kg (70 lbs)
<b>Size</b>	
5700A/5720A	
Height .....	17.8 cm (7 in), standard rack increment, plus 1.5 cm (0.6 in) for feet
Width.....	43.2 cm (17 in), standard rack width
Depth .....	63.0 cm (24.8 in), overall; 57.8 cm (22.7 in), rack depth
5725A	
Height .....	13.3 cm, (5.25 in)
Width and Depth.....	Same as 5700A/5720A. Both units project 5.1 cm, (2 in) from rack front.

**5700A/5720A Series II**

*Operators Manual*

---



## 1-28. Electrical Specifications

*Note*

*Fluke guarantees performance verification using specifications stated to 99% confidence level.*

## 1-29. DC Voltage Specifications

**5720A Series II DC Voltage Specifications**

Range	Resolution	Absolute Uncertainty ± 5 °C from calibration temperature <sup>[1]</sup>				Relative Uncertainty ± 1 °C	
		24 Hours	90 Days	180 Days	1 Year	24 Hours	90 Days
		± (ppm output + µV)					
<b>99 % Confidence Level</b>							
220 mV	10 nV	5 + 0.5	7 + 0.5	8 + 0.5	9 + 0.5	2 + 0.4	2.5 + 0.4
2.2 V	100 nV	3.5 + 0.8	4 + 0.8	4.5 + 0.8	6 + 0.8	2 + 0.8	2.5 + 0.8
11 V	1 µV	2.5 + 3	3 + 3	3.5 + 3	4 + 3	1 + 3	1.5 + 3
22 V	1 µV	2.5 + 5	3 + 5	3.5 + 5	4 + 5	1 + 5	1.5 + 5
220 V	10 µV	3.5 + 50	4 + 50	5 + 50	6 + 50	2 + 50	2.5 + 50
1100 V	100 µV	5 + 500	6 + 500	7 + 500	8 + 500	2.5 + 400	3 + 400
<b>95 % Confidence Level</b>							
220 mV	10 nV	4 + 0.4	6 + 0.4	6.5 + 0.4	7.5 + 0.4	1.6 + 0.4	2 + 0.4
2.2 V	100 nV	3 + 0.7	3.5 + 0.7	4 + 0.7	5 + 0.7	1.6 + 0.7	2 + 0.7
11 V	1 µV	2 + 2.5	2.5 + 2.5	3 + 2.5	3.5 + 2.5	0.8 + 2.5	1.2 + 2.5
22 V	1 µV	2 + 4	2.5 + 4	3 + 4	3.5 + 4	0.8 + 4	1.2 + 4
220 V	10 µV	3 + 40	3.5 + 40	4 + 40	5 + 40	1.6 + 40	2 + 40
1100 V	100 µV	4 + 400	4.5 + 400	6 + 400	6.5 + 400	2 + 400	2.4 + 400
Notes: DC Zeros calibration required every 30 days. 1. For fields strengths >1 V/m but ≤3 V/m, add 0.01 % of range.							

## 5700A Series II DC Voltage Specifications

Range	Resolution	Absolute Uncertainty ± 5 °C from calibration temperature <sup>[1]</sup>				Relative Uncertainty ± 1 °C	
		24 Hours	90 Days	180 Days	1 Year	24 Hours	90 Days
		± (ppm output + μV)					
<b>99 % Confidence Level</b>							
220 mV	10 nV	6.5 + .75	7 + .75	8 + .75	9 + .8	2.5 + .5	4 + .5
2.2 V	100 nV	3.5 + 1.2	6 + 1.2	7 + 1.2	8 + 1.2	2.5 + 1.2	4 + 1.2
11 V	1 μV	3.5 + 3	5 + 4	7 + 4	8 + 4	1.5 + 3	3.5 + 4
22 V	1 μV	3.5 + 6	5 + 8	7 + 8	8 + 8	1.5 + 6	3.5 + 8
220 V	10 μV	5 + 100	6 + 100	8 + 100	9 + 100	2.5 + 100	4 + 100
1100 V	100 μV	7 + 600	8 + 600	10 + 600	11 + 600	3 + 600	4.5 + 600
<b>95 % Confidence Level</b>							
220 mV	10 nV	5.5 + 0.6	6 + 0.6	7 + 0.6	8 + 0.6	2 + 0.4	3.5 + 0.4
2.2 V	100 nV	3.5 + 1	5 + 1	6 + 1	7 + 1	2 + 1	3.5 + 1
11 V	1 mV	3 + 3.5	4 + 3.5	6 + 3.5	7 + 3.5	1.2 + 3	3 + 3.5
22 V	1 mV	3 + 6.5	4 + 6.5	6 + 6.5	7 + 6.5	1.2 + 6	3 + 7
220 V	10 mV	4 + 80	5 + 80	7 + 80	8 + 80	2 + 80	3.5 + 80
1100 V	100 mV	6 + 500	7 + 500	8 + 500	9 + 500	2.4 + 500	4 + 500
Notes:							
DC Zeros calibration required every 30 days.							
1. For fields strengths >1 V/m but ≤ 3 V/m, add 0.01 % of range.							

**DC Voltage Secondary Performance Specifications and Operating Characteristics**

Range	Stability <sup>[1]</sup> ± 1 °C 24 Hours	Temperature Coefficient Adder <sup>[2]</sup>		Linearity ± 1 °C	Noise	
		10 - 40 °C	0 - 10 °C and 40 - 50 °C		Bandwidth 0.1-10 Hz pk-pk	Bandwidth 10 Hz-10 kHz RMS
	± (ppm output + μV)	± (ppm output + μV) / °C		± (ppm output + μV)	μV	
220 mV	0.3 + 0.3	0.4 + 0.1	1.5 + 0.5	1 + 0.2	0.15 + 0.1	5
2.2 V	0.3 + 1	0.3 + 0.1	1.5 + 2	1 + 0.6	0.15 + 0.4	15
11 V	0.3 + 2.5	0.15 + 0.2	1 + 1.5	0.3 + 2	0.15 + 2	50
22 V	0.4 + 5	0.2 + 0.4	1.5 + 3	0.3 + 4	0.15 + 4	50
220 V	0.5 + 40	0.3 + 5	1.5 + 40	1 + 40	0.15 + 60	150
1100 V	0.5 + 200	0.5 + 10	3 + 200	1 + 200	0.15 + 300	500

Notes:

- Stability specifications are included in the Absolute Uncertainty values in the primary specification tables.
- Temperature coefficient is an adder to uncertainty specifications that does *not* apply unless operating more than ±5 °C from calibration temperature.

- Minimum Output** ..... 0 V for all ranges, except 100 V for 1100 V range
- Maximum Load** ..... 50 mA for 2.2 V through 220 V ranges; 20 mA for 1100 V range; 50 Ω output impedance on 220 mV range; all ranges <1000 pF, >25 Ω
- Load Regulation** ..... <(0.2 ppm of output + 0.1 ppm of range), full load to no load
- Line Regulation** ..... <0.1 ppm change, ± 10 % of selected nominal line
- Settling Time** ..... 3 seconds to full accuracy; + 1 second for range or polarity change; + 1 second for 1100 V range
- Overshoot** ..... <5 %
- Common Mode Rejection** ..... 140 dB, DC to 400 Hz
- Remote Sensing** ..... Available 0 V to ±1100 V, on 2.2 V through 1100 V ranges

**1-30. AC Voltage Specifications****5720A Series II AC Voltage Specifications: 99% Confidence Level**

Range	Resolution	Frequency (Hz)	Absolute Uncertainty $\pm 5\text{ }^\circ\text{C}$ from calibration temperature				Relative Uncertainty $\pm 1\text{ }^\circ\text{C}$	
			24 Hours	90 Days	180 Days	1 Year	24 Hours	90 Days
			$\pm$ (ppm output + $\mu\text{V}$ )					
2.2 mV	1 nV	10 - 20	250 + 5	270 + 5	290 + 5	300 + 5	250 + 5	270 + 5
		20 - 40	100 + 5	105 + 5	110 + 5	115 + 5	100 + 5	105 + 5
		40 - 20 k	85 + 5	90 + 5	95 + 5	100 + 5	60 + 5	65 + 5
		20 k - 50 k	220 + 5	230 + 5	240 + 5	250 + 5	85 + 5	95 + 5
		50 k - 100 k	500 + 6	540 + 6	570 + 6	600 + 6	200 + 6	220 + 6
		100 k - 300 k	1000 + 12	1200 + 12	1250 + 12	1300 + 12	350 + 12	400 + 12
		300 k - 500 k	1400 + 25	1500 + 25	1600 + 25	1700 + 25	800 + 25	1000 + 25
		500 k - 1 M	2900 + 25	3100 + 25	3250 + 25	3400 + 25	2700 + 25	3000 + 25
22 mV	10 nV	10 - 20	250 + 5	270 + 5	290 + 5	300 + 5	250 + 5	270 + 5
		20 - 40	100 + 5	105 + 5	110 + 5	115 + 5	100 + 5	105 + 5
		40 - 20 k	85 + 5	90 + 5	95 + 5	100 + 5	60 + 5	65 + 5
		20 k - 50 k	220 + 5	230 + 5	240 + 5	250 + 5	85 + 5	95 + 5
		50 k - 100 k	500 + 6	540 + 6	570 + 6	600 + 6	200 + 6	220 + 6
		100 k - 300 k	1000 + 12	1200 + 12	1250 + 12	1300 + 12	350 + 12	400 + 12
		300 k - 500 k	1400 + 25	1500 + 25	1600 + 25	1700 + 25	800 + 25	1000 + 25
		500 k - 1 M	2900 + 25	3100 + 25	3250 + 25	3400 + 25	2700 + 25	3000 + 25
220 mV	100 nV	10 - 20	250 + 15	270 + 15	290 + 15	300 + 15	250 + 15	270 + 15
		20 - 40	100 + 8	105 + 8	110 + 8	115 + 8	100 + 8	105 + 8
		40 - 20 k	85 + 8	90 + 8	95 + 8	100 + 8	60 + 8	65 + 8
		20 k - 50 k	220 + 8	230 + 8	240 + 8	250 + 8	85 + 8	95 + 8
		50 k - 100 k	500 + 20	540 + 20	570 + 20	600 + 20	200 + 20	220 + 20
		100 k - 300 k	850 + 25	900 + 25	1000 + 25	1100 + 25	350 + 25	400 + 25
		300 k - 500 k	1400 + 30	1500 + 30	1600 + 30	1700 + 30	800 + 30	1000 + 30
		500 k - 1 M	2700 + 60	2900 + 60	3100 + 60	3300 + 60	2600 + 60	2800 + 60
2.2 V	1 $\mu\text{V}$	10 - 20	250 + 50	270 + 50	290 + 50	300 + 50	250 + 50	270 + 50
		20 - 40	95 + 20	100 + 20	105 + 20	110 + 20	95 + 20	100 + 20
		40 - 20 k	45 + 10	47 + 10	50 + 10	52 + 10	30 + 10	40 + 10
		20 k - 50 k	80 + 12	85 + 12	87 + 12	90 + 12	70 + 12	75 + 12
		50 k - 100 k	120 + 40	125 + 40	127 + 40	130 + 40	100 + 40	105 + 40
		100 k - 300 k	380 + 100	420 + 100	460 + 100	500 + 100	270 + 100	290 + 100
		300 k - 500 k	1000 + 250	1100 + 250	1150 + 250	1200 + 250	900 + 250	1000 + 250
		500 k - 1 M	1600 + 400	1800 + 600	1900 + 400	2000 + 400	1200 + 400	1300 + 400
22 V	10 $\mu\text{V}$	10 - 20	250 + 500	270 + 500	290 + 500	300 + 500	250 + 500	270 + 500
		20 - 40	95 + 200	100 + 200	105 + 200	110 + 200	95 + 200	100 + 200
		40 - 20 k	45 + 70	47 + 70	50 + 70	52 + 70	30 + 70	40 + 70
		20 k - 50 k	80 + 120	85 + 120	87 + 120	90 + 120	70 + 120	75 + 120
		50 k - 100 k	110 + 250	115 + 250	117 + 250	120 + 250	100 + 250	105 + 250
		100 k - 300 k	300 + 800	310 + 800	320 + 800	325 + 800	270 + 800	290 + 800
		300 k - 500 k	1000 + 2500	1100 + 2500	1150 + 2500	1200 + 2500	900 + 2500	1000 + 2500
		500 k - 1 M	1500 + 4000	1600 + 4000	1700 + 4000	1800 + 4000	1300 + 4000	1400 + 4000

			$\pm$ (ppm output + mV)					
220 V <sup>[2]</sup>	100 $\mu$ V	10 - 20	250 + 5	270 + 5	290 + 5	300 + 5	250 + 5	270 + 5
		20 - 40	95 + 2	100 + 2	105 + 2	110 + 2	95 + 2	100 + 2
		40 - 20 k	57 + 0.7	60 + 0.7	62 + 0.7	65 + 0.7	45 + 0.7	50 + 0.7
		20 k - 50 k	90 + 1.2	95 + 1.2	97 + 1.2	100 + 1.2	75 + 1.2	80 + 1.2
		50 k - 100 k	160 + 3	170 + 3	175 + 3	180 + 3	140 + 3	150 + 3
		100 k - 300 k	900 + 20	1000 + 20	1050 + 20	1100 + 20	600 + 20	700 + 20
		300 k - 500 k	5000 + 50	5200 + 50	5300 + 50	5400 + 50	4500 + 50	4700 + 50
		500 k - 1 M	8000 + 100	9000 + 100	9500 + 100	10,000 + 100	8000 + 100	8500 + 100
1100 V <sup>[1]</sup>	1 $\mu$ V	15 - 50	300 + 20	320 + 20	340 + 20	360 + 20	300 + 20	320 + 20
		50 - 1 k	70 + 4	75 + 4	80 + 4	85 + 4	50 + 4	55 + 4
<b>5725A Amplifier:</b>								
1100 V	1 mV	40 - 1 k	75 + 4	80 + 4	85 + 4	90 + 4	50 + 4	55 + 4
		1 k - 20 k	105 + 6	125 + 6	135 + 6	165 + 6	85 + 6	105 + 6
		20 k - 30 k	230 + 11	360 + 11	440 + 11	600 + 11	160 + 11	320 + 11
750 V		30 k - 50 k	230 + 11	360 + 11	440 + 11	600 + 11	160 + 11	320 + 11
		50 k - 100k	600 + 45	1300 + 45	1600 + 45	2300 + 45	380 + 45	1200 + 45
Notes:								
1. Maximum output 250 V from 15-50 Hz.								
2. See Volt-Hertz capability in Figure A.								

## 5720A Series II AC Voltage Specifications: 95 % Confidence Level

Range	Resolution	Frequency (Hz)	Absolute Uncertainty ± 5 °C from calibration temperature				Relative Uncertainty ± 1 °C	
			24 Hours	90 Days	180 Days	1 Year	24 Hours	90 Days
			± (ppm output + μV)					
2.2 mV	1 nV	10 - 20	200 + 4	220 + 4	230 + 4	240 + 4	200 + 4	220 + 4
		20 - 40	80 + 4	85 + 4	87 + 4	90 + 4	80 + 4	85 + 4
		40 - 20 k	70 + 4	75 + 4	77 + 4	80 + 4	50 + 4	55 + 4
		20 k - 50 k	170 + 4	180 + 4	190 + 4	200 + 4	70 + 4	80 + 4
		50 k - 100 k	400 + 5	460 + 5	480 + 5	500 + 5	160 + 5	180 + 5
		100 k - 300 k	300 + 10	900 + 10	1000 + 10	1050 + 10	280 + 10	320 + 10
		300 k - 500 k	1100 + 20	1200 + 20	1300 + 20	1400 + 20	650 + 20	800 + 20
500 k - 1 M	2400 + 20	2500 + 20	2600 + 20	2700 + 20	2100 + 20	2400 + 20		
22 mV	10 nV	10 - 20	200 + 4	220 + 4	230 + 4	240 + 4	200 + 4	220 + 4
		20 - 40	80 + 4	85 + 4	87 + 4	90 + 4	80 + 4	85 + 4
		40 - 20 k	70 + 4	75 + 4	77 + 4	80 + 4	50 + 4	55 + 4
		20 k - 50 k	170 + 4	180 + 4	190 + 4	200 + 4	70 + 4	80 + 4
		50 k - 100 k	400 + 5	460 + 5	480 + 5	500 + 5	160 + 5	180 + 5
		100 k - 300 k	300 + 10	900 + 10	1000 + 10	1050 + 10	280 + 10	320 + 10
		300 k - 500 k	1100 + 20	1200 + 20	1300 + 20	1400 + 20	650 + 20	800 + 20
500 k - 1 M	2400 + 20	2500 + 20	2600 + 20	2700 + 20	2100 + 20	2400 + 20		
220 mV	100 nV	10 - 20	200 + 12	220 + 12	230 + 12	240 + 12	200 + 12	220 + 12
		20 - 40	80 + 7	85 + 7	87 + 7	90 + 7	80 + 7	85 + 7
		40 - 20 k	70 + 7	75 + 7	77 + 7	80 + 7	50 + 7	55 + 7
		20 k - 50 k	170 + 7	180 + 7	190 + 7	200 + 7	70 + 7	80 + 7
		50 k - 100 k	400 + 17	420 + 17	440 + 17	460 + 17	160 + 17	180 + 17
		100 k - 300 k	700 + 20	750 + 20	800 + 20	900 + 20	280 + 20	320 + 20
		300 k - 500 k	1100 + 25	1200 + 25	1300 + 25	1400 + 25	650 + 25	800 + 25
500 k - 1 M	2400 + 45	2500 + 45	2600 + 45	2700 + 45	2100 + 45	2400 + 45		
2.2 V	1 mV	10 - 20	200 + 40	220 + 40	230 + 40	240 + 40	200 + 40	220 + 40
		20 - 40	75 + 15	80 + 15	85 + 15	90 + 15	75 + 15	80 + 15
		40 - 20 k	37 + 8	40 + 8	42 + 8	45 + 8	25 + 8	35 + 8
		20 k - 50 k	65 + 10	70 + 10	73 + 10	75 + 10	55 + 10	60 + 10
		50 k - 100 k	100 + 30	105 + 30	107 + 30	110 + 30	80 + 30	85 + 30
		100 k - 300 k	300 + 80	340 + 80	380 + 80	420 + 80	230 + 80	250 + 80
		300 k - 500 k	800 + 200	900 + 200	950 + 200	1000 + 200	700 + 200	800 + 200
500 k - 1 M	1300 + 300	1500 + 300	1600 + 300	1700 + 300	1000 + 300	1100 + 300		
22 V	10 mV	10 - 20	200 + 400	220 + 400	230 + 400	240 + 400	200 + 400	220 + 400
		20 - 40	75 + 150	80 + 150	85 + 150	90 + 150	75 + 150	80 + 150
		40 - 20k	37 + 50	40 + 50	42 + 50	45 + 50	25 + 50	35 + 50
		20k - 50k	65 + 100	70 + 100	73 + 100	75 + 100	55 + 100	60 + 100
		50k - 100k	90 + 200	95 + 200	97 + 200	100 + 200	80 + 200	85 + 200
		100k - 300k	250 + 600	260 + 600	270 + 600	275 + 600	250 + 600	270 + 600
		300k - 500k	800 + 2000	900 + 2000	900 + 2000	1000 + 2000	700 + 2000	800 + 2000
500k - 1M	1200 + 3200	1300 + 3200	1400 + 3200	1500 + 3200	1100 + 3200	1200 + 3200		
			± (ppm output + mV)					
220 V <sup>[2]</sup>	100 mV	10 - 20	200 + 4	220 + 4	230 + 4	240 + 4	200 + 4	220 + 4
		20 - 40	75 + 1.5	80 + 1.5	85 + 1.5	90 + 1.5	75 + 1.5	80 + 1.5
		40 - 20 k	45 + 0.6	47 + 0.6	50 + 0.6	52 + 0.6	35 + 0.6	40 + 0.6
		20 k - 50 k	70 + 1	75 + 1	77 + 1	80 + 1	60 + 1	65 + 1
		50 k - 100 k	120 + 2.5	130 + 2.5	140 + 2.5	150 + 2.5	110 + 2.5	120 + 2.5
		100 k - 300 k	700 + 16	800 + 16	850 + 16	900 + 16	500 + 16	600 + 16
		300 k - 500 k	4000 + 40	4200 + 40	4300 + 40	4400 + 40	3600 + 40	3800 + 40
500 k - 1 M	6000 + 80	7000 + 80	7500 + 80	8000 + 80	6500 + 80	7000 + 80		
1100 V <sup>[1]</sup>	1 mV	15 - 50	240 + 16	260 + 16	280 + 16	300 + 16	240 + 16	260 + 16
		50 - 1 k	55 + 3.5	60 + 3.5	65 + 3.5	70 + 3.5	40 + 3.5	45 + 3.5

<b>5725A Amplifier:</b>								
1100 V	1 mV	40 – 1 k	75 + 4	80 + 4	85 + 4	90 + 4	50 + 4	55 + 4
		1 k – 20 k	105 + 6	125 + 6	135 + 6	165 + 6	85 + 6	105 + 6
		20 k – 30 k	230 + 11	360 + 11	440 + 11	600 + 11	160 + 11	320 + 11
750 V		30 k – 50 k	230 + 11	360 + 11	440 + 11	600 + 11	160 + 11	320 + 11
		50 k – 100 k	600 + 45	1300 + 45	1600 + 45	2300 + 45	380 + 45	1200 + 45
Notes: 1. Maximum output 250 V from 15-50 Hz. 2. See Volt-Hertz capability in Figure A.								

## 5700A Series II AC Voltage Specifications: 99 % Confidence Level

Range	Resolution	Frequency (Hz)	Absolute Uncertainty $\pm 5^\circ\text{C}$ from calibration temperature				Relative Uncertainty $\pm 1^\circ\text{C}$	
			24 Hours	90 Days	180 Days	1 Year	24 Hours	90 Days
			$\pm$ (ppm output + $\mu\text{V}$ )					
2.2 mV	1 nV	10 – 20	500 + 5	550 + 5	600 + 5	600 + 5	500 + 5	550 + 5
		20 – 40	200 + 5	220 + 5	230 + 5	240 + 5	200 + 5	220 + 5
		40 – 20 k	100 + 5	110 + 5	120 + 5	120 + 5	60 + 5	65 + 5
		20 k – 50 k	340 + 5	370 + 5	390 + 5	410 + 5	100 + 5	110 + 5
		50 k – 100 k	800 + 8	900 + 8	950 + 8	950 + 8	220 + 8	240 + 8
		100 k – 300 k	1100 + 15	1200 + 15	1300 + 15	1300 + 15	400 + 15	440 + 15
		300 k – 500 k	1500 + 30	1700 + 30	1700 + 30	1800 + 30	1000 + 30	1100 + 30
		500 k – 1 M	4000 + 40	4400 + 40	4700 + 40	4800 + 40	400 + 30	4400 + 30
22 mV	10 nV	10 – 20	500 + 6	550 + 6	600 + 6	600 + 6	500 + 6	550 + 6
		20 – 40	200 + 6	220 + 6	230 + 6	240 + 6	200 + 6	220 + 6
		40 – 20 k	100 + 6	110 + 6	120 + 6	120 + 6	60 + 6	65 + 6
		20 k – 50 k	340 + 6	370 + 6	390 + 6	410 + 6	100 + 6	110 + 6
		50 k – 100 k	800 + 8	900 + 8	950 + 8	950 + 8	220 + 8	240 + 8
		100 k – 300 k	1100 + 15	1200 + 15	1300 + 15	1300 + 15	400 + 15	440 + 15
		300 k – 500 k	1500 + 30	1700 + 30	1700 + 30	1800 + 30	1000 + 30	1100 + 30
		500 k – 1 M	4000 + 40	4400 + 40	4700 + 40	4800 + 40	4000 + 30	4400 + 30
220 mV	100 nV	10 – 20	500 + 16	550 + 16	600 + 16	600 + 16	500 + 16	550 + 16
		20 – 40	200 + 10	220 + 10	230 + 10	240 + 10	200 + 10	220 + 10
		40 – 20 k	95 + 10	100 + 10	110 + 10	110 + 10	60 + 10	65 + 10
		20 k – 50 k	300 + 10	330 + 10	350 + 10	360 + 10	100 + 10	110 + 10
		50 k – 100 k	750 + 30	800 + 30	850 + 30	900 + 30	220 + 30	240 + 30
		100 k – 300 k	940 + 30	1000 + 30	1100 + 30	1100 + 30	400 + 30	440 + 30
		300 k – 500 k	1500 + 40	1700 + 40	1700 + 40	1800 + 40	1000 + 40	1100 + 40
		500 k – 1 M	3000 + 100	3300 + 100	3500 + 100	3600 + 100	3000 + 100	3300 + 100
2.2 V	1 mV	10 – 20	500 + 100	550 + 100	600 + 100	600 + 100	500 + 100	550 + 100
		20 – 40	150 + 30	170 + 30	170 + 30	180 + 30	150 + 30	170 + 30
		40 – 20 k	70 + 7	75 + 7	80 + 7	85 + 7	40 + 7	45 + 7
		20 k – 50 k	120 + 20	130 + 20	140 + 20	140 + 20	100 + 20	110 + 20
		50 k – 100 k	230 + 80	250 + 80	270 + 80	280 + 80	200 + 80	220 + 80
		100 k – 300 k	400 + 150	440 + 150	470 + 150	480 + 150	400 + 150	440 + 150
		300 k – 500 k	1000 + 400	1100 + 400	1200 + 400	1200 + 400	1000 + 400	1100 + 400
		500 k – 1 M	2000 + 1000	2200 + 1000	2300 + 1000	2400 + 1000	2000 + 1000	2200 + 1000
22 V	10 mV	10 – 20	500 + 1000	550 + 1000	600 + 1000	600 + 1000	500 + 1000	550 + 1000
		20 – 40	150 + 300	170 + 300	170 + 300	180 + 300	150 + 300	170 + 300
		40 – 20 k	70 + 70	75 + 70	80 + 70	85 + 70	40 + 70	45 + 70
		20 k – 50 k	120 + 200	130 + 200	140 + 200	140 + 200	100 + 200	110 + 200
		50 k – 100 k	230 + 400	250 + 400	270 + 400	280 + 400	200 + 400	220 + 400
		100 k – 300 k	500 + 1700	550 + 1700	550 + 1700	600 + 1700	500 + 1700	550 + 1700
		300 k – 500 k	1200 + 5000	1300 + 5000	1300 + 5000	1400 + 5000	1200 + 5000	1300 + 5000
		500 k – 1 M	2600 + 9000	2800 + 9000	2900 + 9000	3000 + 9000	2600 + 9000	2800 + 9000
$\pm$ (ppm output + mV)								
220 V <sup>[2]</sup>	100 mV	10 – 20	500 + 10	550 + 10	600 + 10	600 + 10	500 + 10	550 + 10
		20 – 40	150 + 3	170 + 3	170 + 3	180 + 3	150 + 3	170 + 3
		40 – 20 k	75 + 1	80 + 1	85 + 1	90 + 1	45 + 1	50 + 1
		20 k – 50 k	200 + 4	220 + 4	240 + 4	250 + 4	100 + 1	110 + 1
		50 k – 100 k	500 + 10	550 + 10	600 + 10	600 + 10	300 + 10	330 + 10
		100 k – 300 k	1500 + 110	1500 + 110	1600 + 110	1600 + 110	1500 + 110	1500 + 100
		300 k – 500 k	5000 + 110	5200 + 110	5300 + 110	5400 + 110	5000 + 110	5200 + 110
		500 k – 1 M	12,000 + 220	12,500 + 220	12,500 + 220	13,000 + 220	12,000 + 220	12,000 + 220
1100 V <sup>[1]</sup>	1 mV	15 – 50	400 + 20	420 + 20	440 + 20	460 + 20	400 + 20	420 + 20
		50 – 1 k	75 + 4	80 + 4	85 + 4	90 + 4	50 + 4	55 + 4

<b>5725A Amplifier:</b>								
1100 V	1 mV	40 – 1 k	75 + 4	80 + 4	85 + 4	90 + 4	50 + 4	55 + 4
		1 k – 20 k	105 + 6	125 + 6	135 + 6	165 + 6	85 + 6	105 + 6
		20 k – 30 k	230 + 11	360 + 11	440 + 11	600 + 11	160 + 11	320 + 11
750 V		30 k – 50 k	230 + 11	360 + 11	440 + 11	600 + 11	160 + 11	320 + 11
		50 k – 100 k	600 + 45	1300 + 45	1600 + 45	2300 + 45	380 + 45	1200 + 45
Notes:								
1. Maximum output 250 V from 15-50 Hz.								
2. See Volt-Hertz capability in Figure A.								

## 5700A Series II AC Voltage Specifications: 95 % Confidence Level

Range	Resolution	Frequency (Hz)	Absolute Uncertainty ± 5 °C from calibration temperature				Relative Uncertainty ± 1 °C	
			24 Hours	90 Days	180 Days	1 Year	24 Hours	90 Days
			± (ppm output + μV)					
2.2 mV	1 nV	10 – 20	400 + 4.5	500 + 4.5	530 + 4.5	550 + 4.5	400 + 4.5	500 + 4.5
		20 – 40	170 + 4.5	190 + 4.5	200 + 4.5	210 + 4.5	170 + 4.5	190 + 4.5
		40 – 20 k	85 + 4.5	95 + 4.5	100 + 4.5	105 + 4.5	55 + 4.5	60 + 4.5
		20 k – 50 k	300 + 4.5	330 + 4.5	350 + 4.5	370 + 4.5	90 + 4.5	100 + 4.5
		50 k – 100 k	700 + 7	750 + 7	800 + 7	850 + 7	210 + 7	230 + 7
		100 k – 300 k	900 + 13	1000 + 13	1050 + 13	1100 + 13	380 + 13	420 + 13
		300 k – 500 k	1300 + 25	1500 + 25	1600 + 25	1700 + 25	900 + 25	1000 + 25
		500 k – 1 M	2800 + 25	3100 + 25	3300 + 25	3400 + 25	2900 + 25	3200 + 25
22 mV	10 nV	10 – 20	400 + 5	500 + 5	530 + 5	550 + 5	400 + 5	500 + 5
		20 – 40	170 + 5	190 + 5	200 + 5	210 + 5	170 + 5	190 + 5
		40 – 20 k	85 + 5	95 + 5	100 + 5	105 + 5	55 + 5	60 + 5
		20 k – 50 k	300 + 5	330 + 5	350 + 5	370 + 5	90 + 5	100 + 5
		50 k – 100 k	700 + 7	750 + 7	800 + 7	850 + 7	210 + 7	230 + 7
		100 k – 300 k	900 + 12	1000 + 12	1050 + 12	1100 + 12	380 + 12	420 + 12
		300 k – 500 k	1300 + 25	1500 + 25	1600 + 25	1700 + 25	900 + 25	1000 + 25
		500 k – 1 M	2800 + 25	3100 + 25	3300 + 25	3400 + 25	2900 + 25	3200 + 25
220 mV	100 nV	10 – 20	400 + 13	500 + 13	530 + 13	550 + 13	400 + 13	500 + 13
		20 – 40	170 + 8	190 + 8	200 + 8	210 + 8	170 + 8	190 + 8
		40 – 20 k	85 + 8	95 + 8	100 + 8	105 + 8	55 + 8	60 + 8
		20 k – 50 k	250 + 8	280 + 8	300 + 8	320 + 8	90 + 8	100 + 8
		50 k – 100 k	700 + 25	750 + 25	800 + 25	850 + 25	210 + 25	230 + 25
		100 k – 300 k	900 + 25	1000 + 25	1050 + 25	1100 + 25	380 + 25	420 + 25
		300 k – 500 k	1300 + 35	1500 + 35	1600 + 35	1700 + 35	900 + 35	1000 + 35
		500 k – 1 M	2800 + 80	3100 + 80	3300 + 80	3400 + 80	2900 + 80	3200 + 80
2.2 V	1 mV	10 – 20	400 + 80	450 + 80	480 + 80	500 + 80	400 + 80	450 + 80
		20 – 40	130 + 25	140 + 25	150 + 25	160 + 25	130 + 25	140 + 25
		40 – 20 k	60 + 6	65 + 6	70 + 6	75 + 6	35 + 6	40 + 6
		20 k – 50 k	105 + 16	110 + 16	115 + 16	120 + 16	85 + 16	95 + 16
		50 k – 100 k	190 + 70	210 + 70	230 + 70	250 + 70	170 + 70	190 + 70
		100 k – 300 k	350 + 130	390 + 130	420 + 130	430 + 130	340 + 130	380 + 130
		300 k – 500 k	850 + 350	950 + 350	1000 + 350	1050 + 350	850 + 350	950 + 350
		500 k – 1 M	1700 + 850	1900 + 850	2100 + 850	2200 + 850	1700 + 850	1900 + 850
22 V	10 mV	10 – 20	400 + 800	450 + 800	480 + 800	500 + 800	400 + 800	450 + 800
		20 – 40	130 + 250	140 + 250	150 + 250	160 + 250	130 + 250	140 + 250
		40 – 20 k	60 + 60	65 + 60	70 + 60	75 + 60	35 + 60	40 + 60
		20 k – 50 k	105 + 160	110 + 160	115 + 160	120 + 160	85 + 160	95 + 160
		50 k – 100 k	190 + 350	210 + 350	230 + 350	250 + 350	170 + 350	190 + 350
		100 k – 300 k	400 + 1500	450 + 1500	470 + 1500	500 + 1500	400 + 1500	450 + 1500
		300 k – 500 k	1050 + 4300	1150 + 4300	1200 + 4300	1250 + 4300	1000 + 4300	1100 + 4300
		500 k – 1 M	2300 + 8500	2500 + 8500	2600 + 8500	2700 + 8500	2200 + 8500	2400 + 8500
± (ppm output + mV)								
220 V <sup>[2]</sup>	100 mV	10 – 20	400 + 8	450 + 8	480 + 8	500 + 8	400 + 8	450 + 8
		20 – 40	130 + 2.5	140 + 2.5	150 + 2.5	160 + 2.5	130 + 2.5	140 + 2.5
		40 – 20 k	65 + 0.8	70 + 0.8	75 + 0.8	80 + 0.8	40 + 0.8	45 + 0.8
		20 k – 50 k	170 + 3.5	190 + 3.5	210 + 3.5	220 + 3.5	85 + 3.5	95 + 3.5
		50 k – 100 k	400 + 8	450 + 8	480 + 8	500 + 8	270 + 8	300 + 8
		100 k – 300 k	1300 + 90	1400 + 90	1450 + 90	1500 + 90	1200 + 90	1300 + 90
		300 k – 500 k	4300 + 90	4500 + 90	4600 + 90	4700 + 90	4200 + 90	4500 + 90
500 k – 1 M	10,500 + 190	11,000 + 190	11,300 + 190	11,500 + 190	10,500 + 190	11,000 + 190		
1100 V <sup>[1]</sup>	1 mV	15 – 50	340 + 16	360 + 16	380 + 16	400 + 16	340 + 16	360 + 16
		50 – 1 k	65 + 3.5	70 + 3.5	75 + 3.5	80 + 3.5	45 + 3.5	50 + 3.5

<b>5725A Amplifier:</b>								
1100 V	1 mV	40 – 1 k	75 + 4	80 + 4	85 + 4	90 + 4	50 + 4	55 + 4
		1 k – 20 k	105 + 6	125 + 6	135 + 6	165 + 6	85 + 6	105 + 6
		20 k – 30 k	230 + 11	360 + 11	440 + 11	600 + 11	160 + 11	320 + 11
750 V		30 k – 50 k	230 + 11	360 + 11	440 + 11	600 + 11	160 + 11	320 + 11
		50 k – 100 k	600 + 45	1300 + 45	1600 + 45	2300 + 45	380 + 45	1200 + 45
Notes: 1. Maximum output 250 V from 15-50 Hz. 2. See Volt-Hertz capability in Figure A.								

## AC Voltage Secondary Performance Specifications and Operating Characteristics

Range	Frequency (Hz)	Stability $\pm 1\text{ }^\circ\text{C}$ [1] 24 Hours	Temperature Coefficient		Output Impedance ( $\Omega$ )	Maximum Distortion Bandwidth 10 Hz-10 MHz
			10 – 40 $^\circ\text{C}$	0 – 10 $^\circ\text{C}$ and 40 – 50 $^\circ\text{C}$		
		$\pm\ \mu\text{V}$	$\pm\ \mu\text{V} / \text{ }^\circ\text{C}$		$\pm$ (% output + $\mu\text{V}$ )	
2.2 mV	10 – 20	5	0.05	0.05	50	0.05 + 10
	20 – 40	5	0.05	0.05		0.035 + 10
	40 – 20 k	2	0.05	0.05		0.035 + 10
	20 k – 50 k	2	0.1	0.1		0.035 + 10
	50 k – 100 k	3	0.2	0.2		0.035 + 30
	100 k – 300 k	3	0.3	0.3		0.3 + 30
	300 k – 500 k	5	0.4	0.4		0.3 + 30
	500 k – 1 M	5	0.5	0.5		2 + 50
22 mV	10 – 20	5	0.2	0.3	50	0.05 + 11
	20 – 40	5	0.2	0.3		0.035 + 11
	40 – 20 k	2	0.2	0.3		0.035 + 11
	20 k – 50 k	2	0.4	0.5		0.035 + 11
	50 k – 100 k	3	0.5	0.5		0.035 + 30
	100 k – 300 k	5	0.6	0.6		0.3 + 30
	300 k – 500 k	10	1	1		0.3 + 30
	500 k – 1 M	15	1	1		2 + 30
		$\pm$ (ppm output + $\mu\text{V}$ )	$\pm$ (ppm output $\mu\text{V}$ ) / $^\circ\text{C}$			
220 mV	10 – 20	150 + 20	2 + 1	2 + 1	50	0.05 + 16
	20 – 40	80 + 15	2 + 1	2 + 1		0.035 + 16
	40 – 20 k	12 + 2	2 + 1	2 + 1		0.035 + 16
	20 k – 50 k	10 + 2	15 + 2	15 + 2		0.035 + 16
	50 k – 100 k	10 + 2	15 + 4	15 + 4		0.035 + 30
	100 k – 300 k	20 + 4	80 + 5	80 + 5		0.3 + 30
	300 k – 500 k	100 + 10	80 + 5	80 + 5		0.3 + 30
	500 k – 1 M	200 + 20	80 + 5	80 + 5		1 + 30
					<b>Load Regulation</b> $\pm$ (ppm output+ $\mu\text{V}$ )	
2.2 V	10 – 20	150 + 20	50 + 10	50 + 10	10 + 2	0.05 + 80
	20 – 40	80 + 15	15 + 5	15 + 5	10 + 2	0.035 + 80
	40 – 20 k	12 + 4	2 + 1	5 + 2	10 + 4	0.035 + 80
	20 k – 50 k	15 + 5	10 + 2	15 + 4	30 + 10	0.035 + 80
	50 k – 100 k	15 + 5	10 + 4	20 + 4	120 + 16	0.035 + 110
	100 k – 300 k	30 + 10	80 + 15	80 + 15	300 ppm	0.3 + 110
	300 k – 500 k	70 + 20	80 + 40	80 + 40	600 ppm	0.5 + 110
	500 k – 1 M	150 + 50	80 + 100	80 + 100	1200 ppm	1 + 110
22 V	10 – 20	150 + 20	50 + 100	50 + 100	10 + 20	0.05 + 700
	20 – 40	80 + 15	15 + 30	15 + 40	10 + 20	0.035 + 700
	40 – 20 k	12 + 8	2 + 10	4 + 15	10 + 30	0.035 + 700
	20 k – 50 k	15 + 10	10 + 20	20 + 20	30 + 50	0.035 + 700
	50 k – 100 k	15 + 10	10 + 40	20 + 40	80 + 80	0.05 + 800
	100 k – 300 k	30 + 15	80 + 150	80 + 150	100 + 700	0.3 + 800
	300 k – 500 k	70 + 100	80 + 300	80 + 300	200 + 1100	0.3 + 800
	500 k – 1 M	150 + 100	80 + 500	80 + 500	600 + 3000	2 + 800
220 V	10 – 20	150 + 200	50 + 1000	50 + 1000	10 + 200	0.05 + 10,000
	20 – 40	80 + 150	15 + 300	15 + 300	10 + 200	0.05 + 10,000
	40 – 20 k	12 + 80	2 + 80	4 + 80	10 + 300	0.05 + 10,000
	20 k – 50 k	15 + 100	10 + 100	20 + 100	30 + .600	0.05 + 10,000
	50 k – 100 k	15 + 100	10 + 500	20 + 500	80 + 3,000	0.2 + 50,000
	100 k – 300 k	30 + 400	80 + 600	80 + 600	250 + 25,000	1.5 + 50,000
	300 k – 500 k	100 + 10,000	80 + 800	80 + 800	500 + 50,000	1.5 + 50,000
	500 k – 1 M	200 + 20,000	80 + 1000	80 + 1000	1000 + 110,000	3.5 + 100,000
		$\pm$ (ppm output + mV)	$\pm$ (ppm output) / $^\circ\text{C}$		$\pm$ (ppm output + mV)	$\pm$ (% output)
1100 V	15 – 50	150 + 0.5	50	50	10 + 2	0.15
	50 – 1 k	20 + 0.5	2	5	10 + 1	0.07

5725A Amplifier:							
Range	Frequency (Hz)	Stability $\pm 1\text{ }^\circ\text{C}$ <sup>[1]</sup> 24 Hours	Temperature Coefficient Adder		Load Regulation <sup>[2]</sup>	Distortion Bandwidth 10 Hz -10 MHz $\pm(\% \text{ output})$	
			10 – 40 $^\circ\text{C}$	0 – 10 $^\circ\text{C}$ and 40 – 50 $^\circ\text{C}$		150 pF	1000 pF
		$\pm(\text{ppm output} + \text{mV})$	$\pm(\text{ppm output}) / ^\circ\text{C}$	$\pm(\text{ppm output} + \text{mV})$			
1100 V	40 – 1 k	10 + .5	5	5	10 + 1	0.10	0.10
	1 k – 20 k	15 + 2	5	5	90 + 6	0.10	0.15
	20 k – 50 k	40 + 2	10	10	275 + 11	0.30	0.30
	50 k – 100 k	130 + 2	30	30	500 + 30	0.40	0.40
Notes:							
1. Stability specifications are included in Absolute Uncertainty values for the primary specifications.							
2. The 5725A will drive up to 1000 pF of load capacitance. Uncertainty specifications include loads to 300 pF and 150 pF as shown under "Load Limits." For capacitances up to the maximum of 1000 pF, add "Load Regulation."							

Voltage Range	Maximum Current Limits		Load Limits
2.2 V <sup>[2]</sup>			
22 V	50 mA, 0 $^\circ\text{C}$ -40 $^\circ\text{C}$		>50 $\Omega$ ,
220 V	20 mA, 40 $^\circ\text{C}$ -50 $^\circ\text{C}$		1000 pF
1100 V	6 mA		600 pF
<b>5725A Amplifier:</b>			
1100 V	40 Hz-5 kHz	50 mA	1000 pF <sup>[1]</sup>
	5 kHz-30 kHz	70 mA	300 pF
	30 kHz-100 kHz	70 mA <sup>[3]</sup>	150 pF
Notes:			
1. The 5725A will drive up to 1000 pF of load capacitance. Uncertainty specifications include loads to 300 pF and 150 pF as shown under "Load Limits." For capacitances up to the maximum of 1000 pF, add "Load Regulation."			
2. 2.2 V Range, 100 kHz-1.2 MHz only: uncertainty specifications cover loads to 10 mA or 1000 pF. For higher loads, load regulation is added.			
3. Applies from 0 $^\circ\text{C}$ to 40 $^\circ\text{C}$ .			

- Output Display Formats** ..... Voltage or dBm, dBm reference 600  $\Omega$ .
- Minimum Output** ..... 10 % on each range
- External Sense** ..... Selectable for 2.2 V, 22 V, 220 V, and 1100 V ranges; 5700A/5720A <100 kHz, 5725A <30 kHz

**Settling Time to Full Accuracy**

Frequency (Hz)	Settling Time (seconds)
<20	7
120-120 k	5
>120 k	2
Notes:	
Plus 1 second for amplitude or frequency range change	
Plus 2 seconds for 5700A/5720A 1100 V range	
Plus 4 seconds for 5725A 1100 V range	

**Overshoot** ..... <10 %  
**Common Mode Rejection** ..... 140 dB, DC to 400 Hz

**Frequency**

Ranges (Hz) ..... 10.000 – 119.99  
 0.1200 k – 1.1999 k  
 1.200 k – 11.999 k  
 12.00 k – 119.99 k  
 120.0 k – 1.1999 M

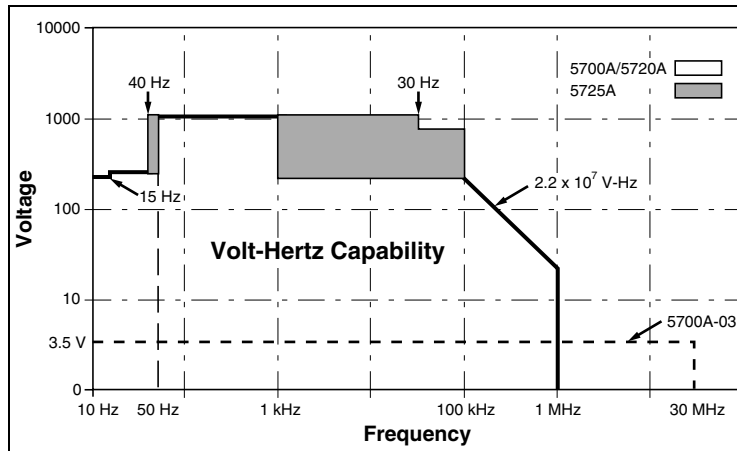
Uncertainty ..... ±0.01 %  
 Resolution ..... 11.999 counts

**Phase Lock** (Selectable Rear Panel BNC Input)

Phase Uncertainty (except 1100 V range) ..... >30 Hz: ±1 ° + 0.05 °/kHz, <30 Hz: ±3 °  
 Input Voltage ..... 1 V to 10 V rms sine wave (do not exceed 1 V for mV ranges)  
 Frequency Range ..... 10 Hz to 1.1999 MHz  
 Lock Range ..... ±2 % of frequency  
 Lock-In Time ..... Larger of 10/frequency or 10 msec

**Phase Reference** (Selectable Rear Panel BNC Output)

Range ..... ±180 °  
 Phase Uncertainty (except 1100 V range) ..... ±1 ° at quadrature points (0 °, ±90 °, ±180 °) elsewhere ±2 °  
 Stability ..... ±0.1 °  
 Resolution ..... 1 °  
 Output Level ..... 2.5 V rms ±0.2 V  
 Frequency Range ..... 50 kHz to 1 kHz, usable 10 Hz to 1.1999 MHz



**Figure A.**

**1-31. Resistance Specifications**

**5720A Series II Resistance Specifications**

Nominal Value ( $\Omega$ )	Absolute Uncertainty of Characterized Value $\pm 5^\circ\text{C}$ from calibration temperature <sup>[1]</sup>				Relative Uncertainty $\pm 1^\circ\text{C}$	
	24 Hours	90 Days	180 Days	1 Year	24 Hours	90 Days
	$\pm\text{ppm}$					
<b>99 % Confidence Level</b>						
0	50 $\mu\Omega$	50 $\mu\Omega$	50 $\mu\Omega$	50 $\mu\Omega$	50 $\mu\Omega$	50 $\mu\Omega$
1	85	95	100	110	32	40
1.9	85	95	100	110	25	33
10	23	25	26	27	5	8
19	23	25	26	27	4	7
100	10	11	11.5	12	2	4
190	10	11	11.5	12	2	4
1 k	8	9	9.5	10	2	3
1.9 k	8	9	9.5	10	2	3
10 k	8	9	9.5	10	2	3
19 k	9	9	9.5	10	2	3
100 k	9	11	12	13	2	3
190 k	9	11	12	13	2	3
1 M	16	18	20	23	2.5	5
1.9 M	1	19	21	24	3	6
10 M	33	37	40	46	10	14
19 M	43	47	50	55	20	24
100 M	100	110	115	120	50	60
<b>95 % Confidence Level</b>						
0	40 $\mu\Omega$	40 $\mu\Omega$	40 $\mu\Omega$	40 $\mu\Omega$	40 $\mu\Omega$	40 $\mu\Omega$
1	70	80	85	95	27	35
1.9	70	80	85	95	20	26
10	20	21	22	23	4	7
19	20	21	22	23	3.5	6
100	8	9	9.5	10	1.6	3.5
190	8	9	9.5	10	1.6	3.5
1 k	6.5	7.5	8	8.5	1.6	2.5
1.9 k	6.5	7.5	8	8.5	1.6	2.5
10 k	6.5	7.5	8	8.5	1.6	2.5
19 k	7.5	7.5	8	8.5	1.6	2.5
100 k	7.5	9	10	11	1.6	2.5
190 k	7.5	9	10	11	1.6	2.5
1 M	13	15	17	20	2	4
1.9 M	14	16	18	21	2.5	4
10 M	27	31	34	40	8	12
19 M	35	39	42	47	16	20
100 M	85	95	100	100	40	50
Note:						
1. Specifications apply to displayed value. 4-wire connections, except 100 M $\Omega$ .						

## 5700A Series II Resistance Specifications

Nominal Value ( $\Omega$ )	Absolute Uncertainty of Characterized Value $\pm 5^\circ\text{C}$ from calibration temperature <sup>[1]</sup>				Relative Uncertainty $\pm 1^\circ\text{C}$	
	24 Hours	90 Days	180 Days	1 Year	24 Hours	90 Days
$\pm\text{ppm}$						
<b>99 % Confidence Level</b>						
0	50 $\mu\Omega$	50 $\mu\Omega$	50 $\mu\Omega$	50 $\mu\Omega$	50 $\mu\Omega$	50 $\mu\Omega$
1	85	95	100	110	32	40
1.9	85	95	100	110	25	33
10	26	28	30	33	5	8
19	24	26	28	31	4	7
100	15	17	18	20	2	4
190	15	17	18	20	2	4
1 k	11	12	13	15	2	3.5
1.9 k	11	12	13	15	2	3.5
10 k	9	11	12	14	2	3.5
19 k	9	11	12	14	2	3.5
100 k	11	13	14	16	2	3.5
190 k	11	13	14	16	2	3.5
1 M	16	18	20	23	2.5	5
1.9 M	17	19	21	24	3.5	6
10 M	33	37	40	46	10	14
19 M	43	47	50	55	20	24
100 M	110	120	125	130	50	60
<b>95 % Confidence Level</b>						
0	50 $\mu\Omega$	50 $\mu\Omega$	50 $\mu\Omega$	50 $\mu\Omega$	50 $\mu\Omega$	50 $\mu\Omega$
1	70	80	85	95	32	40
1.9	70	80	85	95	25	33
10	21	23	27	28	5	8
19	20	22	24	27	4	7
100	13	14	15	17	2	4
190	13	14	15	17	2	4
1 k	9	10	11	13	2	3.5
1.9 k	9	10	11	13	2	3.5
10 k	7.5	9.5	10.5	12	2	3.5
19 k	7.5	9.5	10.5	12	2	3.5
100 k	9	11	12	14	2	3.5
190 k	9	11	12	14	2	3.5
1 M	13	15	17	20	2.5	5
1.9 M	14	16	18	21	3	6
10 M	27	31	34	40	10	14
19 M	35	39	42	47	20	24
100 M	90	100	105	110	50	60
Note:						
1. Specifications apply to displayed value. 4-wire connections, except 100 M $\Omega$ .						

**Resistance Secondary Performance Specifications and Operating Characteristics**

Nominal Value ( $\Omega$ )	Stability $\pm 1^\circ\text{C}$ <sup>[1]</sup> 24 Hours	Temperature Coefficient Adder <sup>[2]</sup>		Full Spec Load Range <sup>[3]</sup> $I_L - I_U$ (mA)	Maximum Peak Current $I_{MAX}$ (mA)	Maximum Difference of Characterized to Nominal Value	Two-Wire Adder Active Compensation <sup>[4]</sup>	
		10 – 40 °C	0 – 10 °C and 40 – 50 °C				Lead Resistance	
	$\pm\text{ppm}$	$\pm\text{ppm}/^\circ\text{C}$		$\pm\text{ppm}$	0.1 $\Omega$	1 $\Omega$	$\pm\text{m}\Omega$	
0	—	—	—	8 – 500	500	—	$2 + \frac{4\mu\text{V}}{I_m}$	$4 + \frac{4\mu\text{V}}{I_m}$
1	32	4	5	8 – 100	700	500	$2 + \frac{4\mu\text{V}}{I_m}$	$4 + \frac{4\mu\text{V}}{I_m}$
1.9	25	6	7	8 – 100	500	500	$2 + \frac{4\mu\text{V}}{I_m}$	$4 + \frac{4\mu\text{V}}{I_m}$
10	5	2	3	8 – 11	220	300	$2 + \frac{4\mu\text{V}}{I_m}$	$4 + \frac{4\mu\text{V}}{I_m}$
19	4	2	3	8 – 11	160	300	$2 + \frac{4\mu\text{V}}{I_m}$	$4 + \frac{4\mu\text{V}}{I_m}$
100	2	2	3	8 – 11	70	150	$2 + \frac{4\mu\text{V}}{I_m}$	$4 + \frac{4\mu\text{V}}{I_m}$
190	2	2	3	8 – 11	50	150	$2 + \frac{4\mu\text{V}}{I_m}$	$4 + \frac{4\mu\text{V}}{I_m}$
1 k	2	2	3	1 – 2	22	150	10	15
1.9 k	2	2	3	1 – 1.5	16	150	10	15
10 k	2	2	3	100 – 500 $\mu\text{A}$	7	150	50	60
19 k	2	2	3	50 – 250 $\mu\text{A}$	5	150	100	120
100 k	2	2	3	10 – 100 $\mu\text{A}$	1	150	$I_m$ = Current produced by Ohmmeter (A)	
190 k	2	2	3	5 – 50 $\mu\text{A}$	500 $\mu\text{A}$	150		
1 M	2.5	2.5	6	5 – 20 $\mu\text{A}$	100 $\mu\text{A}$	200		
1.9 M	3.5	3	10	2.5 – 10 $\mu\text{A}$	50 $\mu\text{A}$	200		
10 M	10	5	20	0.5 – 2 $\mu\text{A}$	10 $\mu\text{A}$	300		
19 M	20	8	40	0.25 – 1 $\mu\text{A}$	5 $\mu\text{A}$	300		
100 M	50	12	100	50 – 200 nA	1 $\mu\text{A}$	500		

Notes:

1. Stability specifications are included in the Absolute Uncertainty values in the primary specification tables.
2. Temperature coefficient is an adder to uncertainty specifications that does not apply unless operated more than 5 °C from calibration temperature, or calibrated outside the range 19 °C to 24 °C. Two examples:  
 - Calibrate at 20 °C: Temperature coefficient adder is not required unless operated below 15 °C or above 25 °C.  
 - Calibrate at 26 °C: Add 2 °C temperature coefficient adder. Additional temperature coefficient adder is not required unless operated below 21 °C or above 31 °C.
3. Refer to current derating factors table for loads outside of this range.
4. Active two-wire compensation may be selected for values less than 100 k $\Omega$ , with either the front panel or the meter input terminals as reference plane. Active compensation is limited to 11 mA load, and to 2 V burden. Two-wire compensation can be used only with  $\Omega$ -meters that source continuous (not pulsed) dc current.

## Current Derating Factors

Nominal Value ( $\Omega$ )	Value of Derating Factor K for Over or Under Current		
	Two-Wire Comp $I < I_L$ [1]	Four-Wire $I < I_L$ [1]	Four-Wire $I_U < I < I_{MAX}$ [2]
SHORT	4.4	0.3	—
1	4.4	300	$4 \times 10^{-5}$
1.9	4.4	160	$1.5 \times 10^{-4}$
10	4.4	30	$1.6 \times 10^{-3}$
19	4.4	16	$3 \times 10^{-3}$
100	4.4	3.5	$1 \times 10^{-2}$
190	4.4	2.5	$1.9 \times 10^{-2}$
1 k	4.4	0.4	0.1
1.9 k	4.4	0.4	0.19
10 k	5000	50	2.0
19 k	5000	50	3.8
100 k	—	7.5	$2 \times 10^{-5}$
190 k	—	4.0	$3.8 \times 10^{-5}$
1 M	—	1.0	$1.5 \times 10^{-4}$
1.9 M	—	0.53	$2.9 \times 10^{-4}$
10 M	—	0.2	$1 \times 10^{-3}$
19 M	—	0.53	$1.9 \times 10^{-3}$
100 M	—	0.1	—

Notes:

0 For  $I < I_L$ , errors occur due to thermally generated voltages within the 5720A. Use the following equation to determine the error, and add this error to the corresponding uncertainty or stability specification.

$$\text{Error} = K(I_L - I) / (I_L \times I)$$

Where: Error is in  $m\Omega$  for all two-wire comp values and four-wire short, and in ppm for the remaining four-wire values.  
K is the constant from the above table;  
I and  $I_L$  are expressed in mA for short to 1.9 k $\Omega$ ;  
I and  $I_L$  are expressed in  $\mu A$  for 10 k $\Omega$  to 100 M $\Omega$

2. For  $I_U < I < I_{MAX}$  errors occur due to self-heating of the resistors in the calibrator. Use the following equation to determine the error in ppm and add this error to the corresponding uncertainty or stability specification.

$$\text{Error in ppm} = K(I^2 - I_U^2)$$

Where: K is the constant from the above table;  
I and  $I_U$  are expressed in mA for short to 19 k $\Omega$ ;  
I and  $I_U$  are expressed in  $\mu A$  for 100 k $\Omega$  to 100 M $\Omega$

## 1-32. DC Current Specifications

### 5720A Series II DC Current Specifications

Range	Resolution	Absolute Uncertainty ±5 °C from calibration temperature <sup>[2]</sup>				Relative Uncertainty ±1 °C	
		24 Hours	90 Days	180 Days	1 Year	24 Hours	90 Days
	nA	± (ppm output + nA)					
<b>99 % Confidence Level</b>							
220 µA	0	40 + 7	42 + 7	45 + 7	50 + 7	24 + 2	26 + 2
2.2 mA	1	30 + 8	35 + 8	37 + 8	40 + 8	24 + 5	26 + 5
22 mA	10	30 + 50	35 + 50	37 + 50	40 + 50	24 + 50	26 + 50
	µA	± (ppm output + µA)					
220 mA <sup>[1]</sup>	0.1	40 + 0.8	45 + 0.8	47 + 0.8	50 + 0.8	26 + 0.3	30 + 0.3
2.2 A <sup>[1]</sup>	1	60 + 15	70 + 15	80 + 15	90 + 15	40 + 7	45 + 7
<b>5725A Amplifier:</b>							
11 A	10	330 + 470	340 + 480	350 + 480	360 + 480	100 + 130	110 + 130
<b>95 % Confidence Level</b>							
	nA	± (ppm output + nA)					
220 µA	0.1	32 + 6	35 + 6	37 + 6	40 + 6	20 + 1.6	22 + 1.6
2.2 mA	1	25 + 7	30 + 7	33 + 7	35 + 7	20 + 4	22 + 4
22 mA	10	25 + 40	30 + 40	33 + 40	35 + 40	20 + 40	22 + 40
	µA	± (ppm output + µA)					
220 mA <sup>[1]</sup>	0.1	35 + 0.7	40 + 0.7	42 + 0.7	45 + 0.7	22 + 0.25	25 + 0.25
2.2 A <sup>[1]</sup>	1	50 + 12	60 + 12	70 + 12	80 + 12	32 + 6	40 + 6
<b>5725A Amplifier:</b>							
11 A	10	330 + 470	340 + 480	350 + 480	360 + 480	100 + 130	110 + 130
<p>Note:</p> <p>Maximum output from the calibrator's terminals is 2.2 A. Uncertainty specifications for 220 mA and 2.2 mA ranges are increased by a factor of 1.3 when supplied through 5725A terminals.</p> <p>Specifications are otherwise identical for all output locations.</p> <ol style="list-style-type: none"> <li>1. Add to uncertainty specifications: <ul style="list-style-type: none"> <li>±200 × I<sup>2</sup> ppm for &gt;100 mA on 220 mA range</li> <li>±10 × I<sup>2</sup> ppm for &gt;1 A on 2.2 A range</li> </ul> </li> <li>2. For fields strengths &gt;0.4 V/m but ≤3 V/m, add 1 % of range.</li> </ol>							

## 5700A Series II DC Current Specifications

Range	Resolution	Absolute Uncertainty $\pm 5^\circ\text{C}$ from calibration temperature <sup>[2]</sup>				Relative Uncertainty $\pm 1^\circ\text{C}$	
		24 Hours	90 Days	180 Days	1 Year	24 Hours	90 Days
	nA	$\pm$ (ppm output + nA)					
<b>99 % Confidence Level</b>							
220 $\mu\text{A}$	0.1	45 + 10	50 + 10	55 + 10	60 + 10	24 + 2	26 + 2
2.2 mA	1	45 + 10	50 + 10	55 + 10	60 + 10	24 + 5	26 + 5
22 mA	10	45 + 100	50 + 100	55 + 100	60 + 100	24 + 50	26 + 50
	$\mu\text{A}$	$\pm$ (ppm output + $\mu\text{A}$ )					
220 mA <sup>[1]</sup>	0.1	55 + 1	60 +	65 + 1	70 + 1	26 + 0.3	30 + 0.3
2.2 A <sup>[1]</sup>	1	75 + 30	80 + 30	90 + 30	95 + 30	40 + 7	45 + 7
<b>5725A Amplifier:</b>							
11 A	10	330 + 470	340 + 480	350 + 480	360 + 480	100 + 130	110 + 130
<b>95 % Confidence Level</b>							
	nA	$\pm$ (ppm output + nA)					
220 $\mu\text{A}$	0.1	35 + 8	40 + 8	45 + 8	50 + 8	20 + 1.6	22 + 1.6
2.2 mA	1	35 + 8	40 + 8	45 + 8	50 + 8	20 + 4	22 + 4
22 mA	10	35 + 80	40 + 80	45 + 80	50 + 80	20 + 40	22 + 40
	$\mu\text{A}$	$\pm$ (ppm output + $\mu\text{A}$ )					
220 mA <sup>[1]</sup>	0.1	45 + 0.8	50 + 0.8	55 + 0.8	60 + 0.8	22 + 0.25	25 + 0.25
2.2 A <sup>[1]</sup>	1	60 + 25	65 + 25	75 + 25	80 + 25	35 + 6	40 + 6
<b>5725A Amplifier:</b>							
11 A	10	330 + 470	340 + 480	350 + 480	360 + 480	100 + 130	110 + 130
<p>Note:</p> <p>Maximum output from the calibrator's terminals is 2.2 A. Uncertainty specifications for 220 mA and 2.2 mA ranges are increased by a factor of 1.3 when supplied through 5725A terminals.</p> <p>Specifications are otherwise identical for all output locations.</p> <ol style="list-style-type: none"> <li>Add to uncertainty specifications: <ul style="list-style-type: none"> <li><math>\pm 200 \times I^2</math> ppm for &gt;100 mA on 220 mA range</li> <li><math>\pm 10 \times I^2</math> ppm for &gt;1 A on 2.2 A range</li> </ul> </li> <li>For fields strengths &gt;0.4 V/m but <math>\leq 3</math> V/m, add 1 % of range.</li> </ol>							

**DC Current Secondary Performance Specifications and Operating Characteristics**

Range	Stability $\pm 1\text{ }^\circ\text{C}$ <sup>[1]</sup> 24 Hours	Temperature Coefficient <sup>[2]</sup>		Compliance Limits	Burden Voltage Adder <sup>[3]</sup> ( $\pm\text{nA/V}$ )	Maximum Load for Full Accuracy <sup>[4]</sup> ( $\Omega$ )	Noise	
		10 – 40 $^\circ\text{C}$	0 – 10 $^\circ\text{C}$ and 40 – 50 $^\circ\text{C}$				Bandwidth 0.1-10 Hz	Bandwidth 10 Hz-10 kHz
	$\pm$ (ppm output + nA)	$\pm$ (ppm output + nA) / $^\circ\text{C}$					pk-pk	RMS
220 $\mu\text{A}$	5 + 1	1 + 0.40	3 + 1	10	0.2	20k	6 + .9	10
2.2 mA	5 + 5	1 + 2	3 + 10	10	0.2	2k	6 + 5	10
22 mA	5 + 50	1 + 20	3 + 100	10	10	200	6 + 50	50
220 mA	8 + 300	1 + 200	3 + 1 $\mu\text{A}$	10	100	20	9 + 300	500
2.2 A	9 + 7 $\mu\text{A}$	1 + 2.5 $\mu\text{A}$	3 + 10 $\mu\text{A}$	3 <sup>[5]</sup>	2 $\mu\text{A}$	2	12 + 1.5 $\mu\text{A}$	20 $\mu\text{A}$
<b>5725A</b>	$\pm$ (ppm output + $\mu\text{A}$ )	$\pm$ (ppm output + $\mu\text{A}$ ) / $^\circ\text{C}$					ppm output + $\mu\text{A}$	$\mu\text{A}$
11 A	25 + 100	20 + 75	30 + 120	4	0	4	15 + 70	175

Notes:

Maximum output from the calibrator's terminals is 2.2 A. Uncertainty specifications for 220 mA and 2.2 mA ranges are increased by a factor of 1.3 when supplied through 5725A terminals.

1. Stability specifications are included in the Absolute Uncertainty values for the primary specifications.
2. Temperature coefficient is an adder to uncertainty specifications. It does not apply unless operating more than  $\pm 5\text{ }^\circ\text{C}$  from calibration temperature.
3. Burden voltage adder is an adder to uncertainty specifications that does not apply unless burden voltage is greater than 0.5 V.
4. For higher loads, multiply uncertainty specification by:  $1 + \frac{0.1 \times \text{actual load}}{\text{maximum load for full accuracy}}$
5. The calibrator's compliance limit is 2 V for outputs from 1 A to 2.2 A. 5725A Amplifier may be used in range-lock mode down to 0 A.

**Minimum Output:** ..... 0 for all ranges, including 5725A.

**Settling Time:** ..... 1 second for mA and mA ranges; 3 seconds for 2.2 A range; 6 seconds for 11 range; + 1 second for range or polarity change

**Overshoot:** ..... <5 %

### 1-33. AC Current Specifications

#### 5720A Series II AC Current Specifications: 99 % Confidence Level

Range	Resolution	Frequency (Hz)	Absolute Uncertainty $\pm 5^\circ\text{C}$ from calibration temperature <sup>[1]</sup>				Relative Uncertainty $\pm 1^\circ\text{C}$	
			24 Hours	90 Days	180 Days	1 Year	24 Hours	90 Days
			$\pm$ (ppm output + nA)					
220 $\mu\text{A}$	1 nA	10 – 20	260 + 20	280 + 20	290 + 20	300 + 20	260 + 20	280 + 20
		20 – 40	170 + 12	180 + 12	190 + 12	200 + 12	130 + 12	150 + 12
		40 – 1 k	120 + 10	130 + 10	135 + 10	140 + 10	100 + 10	110 + 10
		1k – 5 k	300 + 15	320 + 15	340 + 15	350 + 15	250 + 15	280 + 15
		5k – 10 k	1000 + 80	1100 + 80	1200 + 80	1300 + 80	900 + 80	1000 + 80
2.2 mA	10 nA	10 – 20	260 + 50	280 + 50	290 + 50	300 + 50	260 + 50	280 + 50
		20 – 40	170 + 40	180 + 40	190 + 40	200 + 40	130 + 40	150 + 40
		40 – 1 k	120 + 40	130 + 40	135 + 40	140 + 40	100 + 40	110 + 40
		1k – 5 k	210 + 130	220 + 130	230 + 130	240 + 130	250 + 130	280 + 130
		5k – 10 k	1000 + 800	1100 + 800	1200 + 800	1300 + 800	900 + 800	1000 + 800
22 mA	100 nA	10 – 20	260 + 500	280 + 500	290 + 500	300 + 500	260 + 500	280 + 500
		20 – 40	170 + 400	180 + 400	190 + 400	200 + 400	130 + 400	150 + 400
		40 – 1 k	120 + 400	130 + 400	135 + 400	140 + 400	100 + 400	110 + 400
		1k – 5 k	210 + 700	220 + 700	230 + 700	240 + 700	250 + 700	280 + 700
		5k – 10 k	1000 + 6000	1100 + 6000	1200 + 6000	1300 + 6000	900 + 6000	1000 + 6000
			$\pm$ (ppm output + $\mu\text{A}$ )					
220 mA	1 $\mu\text{A}$	10 – 20	260 + 5	280 + 5	290 + 5	300 + 5	260 + 5	280 + 5
		20 – 40	170 + 4	180 + 4	190 + 4	200 + 4	130 + 4	150 + 4
		40 – 1 k	120 + 3	130 + 3	135 + 3	140 + 3	100 + 3	110 + 3
		1k – 5 k	210 + 4	220 + 4	230 + 4	240 + 4	250 + 4	280 + 4
		5k – 10 k	1000 + 12	1100 + 12	1200 + 12	1300 + 12	900 + 12	1000 + 12
2.2 A	10 $\mu\text{A}$	20 – 1 k	290 + 40	300 + 40	310 + 40	320 + 40	300 + 40	350 + 40
		1 k – 5 k	440 + 100	460 + 100	480 + 100	500 + 100	500 + 100	520 + 100
		5 k – 10 k	6000 + 200	7000 + 200	7500 + 200	8000 + 200	6000 + 200	7000 + 200
<b>5725A Amplifier:</b>								
11 A	100 $\mu\text{A}$	40 – 1 k	370 + 170	400 + 170	440 + 170	460 + 170	300 + 170	330 + 170
		1 k – 5 k	800 + 380	850 + 380	900 + 380	950 + 380	700 + 380	800 + 380
		5 k – 10 k	3000 + 750	3300 + 750	3500 + 750	3600 + 750	2800 + 750	3200 + 750
<p>Note:</p> <p>Maximum output from the calibrator's terminals is 2.2 A. Uncertainty specifications for 220 <math>\mu\text{A}</math> and 2.2 mA ranges are increased by a factor of 1.3 plus 2 <math>\mu\text{A}</math> when supplied through 5725A terminals. For the 5720A 220 <math>\mu\text{A}</math> range, 1 kHz through 5 kHz and 5 kHz through 10 kHz, when the output is coming from the AUX current terminal, use the 5700A Absolute Uncertainty Specifications. Specifications are otherwise identical for all output locations.</p> <p>1. For fields strengths <math>&gt;0.4</math> V/m but <math>\leq 3</math> V/m, add 1 % of range.</p>								

**5720A Series II AC Current Specifications: 95% Confidence Level**

Range	Resolution	Frequency (Hz)	Absolute Uncertainty ±5 °C from calibration temperature <sup>[1]</sup>				Relative Uncertainty ±1 °C	
			24 Hours	90 Days	180 Days	1 Year	24 Hours	90 Days
			± (ppm output + nA)					
220 µA	1 nA	10 – 20	210 + 16	230 + 16	240 + 16	250 + 16	210 + 16	230 + 16
		20 – 40	130 + 10	140 + 10	150 + 10	160 + 10	110 + 10	130 + 10
		40 – 1 k	100 + 8	110 + 8	115 + 8	120 + 8	80 + 8	90 + 8
		1k – 5 k	240 + 12	250 + 12	270 + 12	280 + 12	200 + 12	230 + 12
		5k – 10 k	800 + 65	900 + 65	1000 + 65	1100 + 65	700 + 65	800 + 65
2.2 mA	10 nA	10 – 20	210 + 40	230 + 40	240 + 40	250 + 40	210 + 40	230 + 40
		20 – 40	140 + 35	140 + 35	150 + 35	160 + 35	110 + 35	130 + 35
		40 – 1 k	100 + 35	110 + 35	115 + 35	120 + 35	80 + 35	90 + 35
		1k – 5 k	170 + 110	180 + 110	190 + 110	200 + 110	200 + 110	230 + 110
		5k – 10 k	800 + 650	900 + 650	1000 + 650	1100 + 650	700 + 650	800 + 650
22 mA	100 nA	10 – 20	210 + 400	230 + 400	240 + 400	250 + 400	210 + 400	230 + 400
		20 – 40	130 + 350	140 + 350	150 + 350	160 + 350	110 + 350	130 + 350
		40 – 1 k	100 + 350	110 + 350	115 + 350	120 + 350	80 + 350	90 + 350
		1k – 5 k	170 + 550	180 + 550	190 + 550	200 + 550	200 + 550	230 + 550
		5k – 10 k	800 + 5000	900 + 5000	1000 + 5000	1100 + 5000	700 + 5000	800 + 5000
			± (ppm output + µA)					
220 mA	1 µA	10 – 20	210 + 4	230 + 4	240 + 4	250 + 4	210 + 4	230 + 4
		20 – 40	130 + 3.5	140 + 3.5	150 + 3.5	160 + 3.5	110 + 3.5	130 + 3.5
		40 – 1 k	100 + 2.5	110 + 2.5	115 + 2.5	120 + 2.5	80 + 2.5	90 + 2.5
		1k – 5 k	170 + 3.5	180 + 3.5	190 + 3.5	200 + 3.5	200 + 3.5	230 + 3.5
		5k – 10 k	800 + 10	900 + 10	1000 + 10	1100 + 10	700 + 10	800 + 10
2.2 A	10 µA	20 – 1 k	230 + 35	240 + 35	250 + 35	260 + 35	250 + 35	300 + 35
		1 k – 5 k	350 + 80	390 + 80	420 + 80	450 + 80	400 + 80	440 + 80
		5 k – 10 k	5000 + 160	6000 + 160	6500 + 160	7000 + 160	5000 + 160	6000 + 160
<b>5725A Amplifier:</b>								
11 A	100 µA	40 – 1 k	370 + 170	400 + 170	440 + 170	460 + 170	300 + 170	330 + 170
		1 k – 5 k	800 + 380	850 + 380	900 + 380	950 + 380	700 + 380	800 + 380
		5 k – 10 k	3000 + 750	3300 + 750	3500 + 750	3600 + 750	2800 + 750	3200 + 750
<p>Note:</p> <p>Maximum output from the calibrator's terminals is 2.2 A. Uncertainty specifications for 220 µA and 2.2 mA ranges are increased by 1.3 plus 2 µA when supplied through 5725A terminals. For the 5720A 220 µA range, 1 kHz through 5 kHz and 5 kHz through 10 kHz, when the output is coming from the AUX current terminal, use the 5700A Absolute Uncertainty Specifications. Specifications are otherwise identical for all output locations.</p> <p>1. For fields strengths &gt;0.4 V/m but ≤3 V/m, add 1 % of range.</p>								

## 5700A Series II AC Current Specifications: 99 % Confidence Level

Range	Resolution	Frequency(Hz)	Absolute Uncertainty ±5 °C from calibration temperature <sup>[1]</sup>				Relative Uncertainty ±1 °C	
			24 Hours	90 Days	180 Days	1 Year	24 Hours	90 Days
			± (ppm output + nA)					
220 µA	1 nA	10 – 20	650 + 30	700 + 30	750 + 30	800 + 30	450 + 30	500 + 30
		20 – 40	350 + 25	380 + 25	410 + 25	420 + 25	270 + 25	300 + 25
		40 – 1 k	120 + 20	140 + 20	150 + 20	160 + 20	110 + 20	120 + 20
		1k – 5 k	500 + 50	600 + 50	650 + 50	700 + 50	450 + 50	500 + 50
		5k – 10 k	1500 + 100	1600 + 100	1700 + 100	1800 + 100	1400 + 100	1500 + 100
2.2 mA	10 nA	10 – 20	650 + 50	700 + 50	750 + 50	800 + 50	450 + 50	500 + 50
		20 – 40	350 + 40	380 + 40	410 + 40	420 + 40	270 + 40	300 + 40
		40 – 1 k	120 + 40	140 + 40	150 + 40	160 + 40	110 + 40	120 + 40
		1k – 5 k	500 + 500	600 + 500	650 + 500	700 + 500	450 + 500	500 + 500
		5k – 10 k	1500 + 1000	1600 + 1000	1700 + 1000	1800 + 1000	1400 + 1000	1500 + 1000
22 mA	100 nA	10 – 20	650 + 500	700 + 500	750 + 500	800 + 500	450 + 500	500 + 500
		20 – 40	350 + 400	380 + 400	410 + 400	420 + 400	270 + 400	300 + 400
		40 – 1 k	120 + 400	140 + 400	150 + 400	160 + 400	110 + 400	120 + 400
		1k – 5 k	500 + 5000	600 + 5000	650 + 5000	700 + 5000	450 + 5000	500 + 5000
		5k – 10 k	1500 + 10,000	1600 + 10,000	1700 + 10,000	1800 + 10,000	1400 + 10,000	1500 + 10,000
			± (ppm output + µA)					
220 mA	1 µA	10 – 20	650 + 5	700 + 5	750 + 5	800 + 5	450 + 5	500 + 5
		20 – 40	350 + 4	380 + 4	410 + 4	420 + 4	280 + 4	300 + 4
		40 – 1 k	120 + 4	150 + 4	170 + 4	180 + 4	110 + 4	130 + 4
		1k – 5 k	500 + 50	600 + 50	650 + 50	700 + 50	450 + 50	500 + 50
		5k – 10 k	1500 + 100	1600 + 100	1700 + 100	1800 + 100	1400 + 100	1500 + 100
2.2 A	10 µA	20 – 1 k	600 + 40	650 + 40	700 + 40	750 + 40	600 + 40	650 + 40
		1 k – 5 k	700 + 100	750 + 100	800 + 100	850 + 100	650 + 100	750 + 100
		5 k – 10 k	8000 + 200	9000 + 200	9500 + 200	10,000 + 200	7500 + 200	8500 + 200
<b>5725A Amplifier:</b>								
11 A	100 µA	40 – 1 k	370 + 170	400 + 170	440 + 170	460 + 170	300 + 170	330 + 170
		1 k – 5 k	800 + 380	850 + 380	900 + 380	950 + 380	700 + 380	800 + 380
		5 k – 10 k	3000 + 750	3300 + 750	3500 + 750	3600 + 750	2800 + 750	3200 + 750
Note:								
Maximum output from the calibrator's terminals is 2.2 A. Uncertainty specifications for 220 µA and 2.2 mA ranges are increased by a factor of 1.3 plus 2 µA when supplied through 5725A terminals. Specifications are otherwise identical for all output locations.								
1. For field strengths >0.4 V/m but ≤3 V/m, add 1 % of range.								

**5700A Series II AC Current Specifications: 95 % Confidence Level**

Range	Resolution	Frequency (Hz)	Absolute Uncertainty ±5 °C from calibration temperature <sup>[1]</sup>				Relative Uncertainty ±1 °C	
			24 Hours	90 Days	180 Days	1 Year	24 Hours	90 Days
			± (ppm output + nA)					
220 µA	1 nA	10 – 20	550 + 25	600 + 25	650 + 25	700 + 25	375 + 25	400 + 25
		20 – 40	280 + 20	310 + 20	330 + 20	350 + 20	220 + 20	250 + 20
		40 – 1 k	100 + 16	120 + 16	130 + 16	140 + 16	90 + 16	100 + 16
		1k – 5 k	400 + 40	500 + 40	550 + 40	600 + 40	375 + 40	400 + 40
		5k – 10 k	1300 + 80	1400 + 80	1500 + 80	1600 + 80	1200 + 80	1200 + 80
2.2 mA	10 nA	10 – 20	550 + 40	600 + 40	650 + 40	700 + 40	375 + 40	400 + 40
		20 – 40	280 + 35	310 + 35	330 + 35	350 + 35	220 + 35	250 + 35
		40 – 1 k	100 + 35	120 + 35	130 + 35	140 + 35	090 + 35	100 + 35
		1k – 5 k	400 + 400	500 + 400	550 + 400	600 + 400	375 + 400	400 + 400
		5k – 10 k	1300 + 800	1400 + 800	1500 + 800	1600 + 800	1200 + 800	1200 + 800
22 mA	100 nA	10 – 20	550 + 400	600 + 400	650 + 400	700 + 400	375 + 400	400 + 400
		20 – 40	280 + 350	310 + 350	330 + 350	350 + 350	220 + 350	250 + 350
		40 – 1 k	100 + 350	120 + 350	130 + 350	140 + 350	090 + 350	100 + 350
		1k – 5 k	400 + 4000	500 + 4000	550 + 4000	600 + 4000	375 + 4000	400 + 4000
		5k – 10 k	1300 + 8000	1400 + 8000	1500 + 8000	1600 + 8000	1200 + 8000	1200 + 8000
			± (ppm output + µA)					
220 mA	1 µA	10 – 20	550 + 4	600 + 4	650 + 4	700 + 4	375 + 4	400 + 4
		20 – 40	280 + 3.5	310 + 3.5	330 + 3.5	350 + 3.5	220 + 3.5	250 + 3.5
		40 – 1 k	100 + 3.5	120 + 3.5	130 + 3.5	140 + 3.5	90 + 3.5	100 + 3.5
		1k – 5 k	400 + 40	500 + 40	550 + 40	600 + 40	375 + 40	400 + 40
		5k – 10 k	1300 + 80	1400 + 80	1500 + 80	1600 + 80	1200 + 80	1200 + 80
2.2 A	10 µA	20 – 1 k	500 + 35	550 + 35	600 + 35	650 + 35	500 + 35	550 + 35
		1 k – 5 k	600 + 80	650 + 80	700 + 80	750 + 80	550 + 80	650 + 80
		5 k – 10 k	6500 + 160	7500 + 160	8000 + 1600	8500 + 160	6000 + 160	7000 + 160
<b>5725A Amplifier:</b>								
11 A	100 µA	40 – 1 k	370 + 170	400 + 170	440 + 170	460 + 170	300 + 170	330 + 170
		1 k – 5 k	800 + 380	850 + 380	900 + 380	950 + 380	700 + 380	800 + 380
		5 k – 10 k	3000 + 750	3300 + 750	3500 + 750	3600 + 750	2800 + 750	3200 + 750
<p>Note:</p> <p>Maximum output from the calibrator's terminals is 2.2 A. Uncertainty specifications for 220 A and 2.2 mA ranges are increased by a factor of 1.3 plus 2 µA when supplied through 5725A terminals. Specifications are otherwise identical for all output locations.</p> <p>1. For fields strengths &gt;0.4 V/m but ≤3 V/m, add 1 % of range.</p>								

## AC Current Secondary Performance Specifications and Operating Characteristics

Range	Frequency (Hz)	Stability $\pm 1^\circ\text{C}$ <sup>[1]</sup> 24 Hours	Temperature Coefficient <sup>[2]</sup>		Compliance Limits (V rms)	Maximum Resistive Load For Full Accuracy <sup>[3]</sup> ( $\Omega$ )	Noise and Distortion (Bandwidth 10 Hz – 50 kHz <0.5V Burden)
			10 – 40 $^\circ\text{C}$	0 – 10 $^\circ\text{C}$ and 40 – 50 $^\circ\text{C}$			
		$\pm$ (ppm output + nA)	$\pm$ (ppm output + nA)/ $^\circ\text{C}$				$\pm$ (% output + $\mu\text{A}$ )
220 $\mu\text{A}$	10 – 20	150 + 5	50 + 5	50 + 5	7	2 k <sup>[6]</sup>	0.05 + 0.1
	20 – 40	80 + 5	20 + 5	20 + 5			0.05 + 0.1
	40 – 1 k	30 + 3	4 + 0.5	10 + 0.5			0.05 + 0.1
	1 k – 5 k	50 + 20	10 + 1	20 + 1			0.25 + 0.5
	5 k – 10 k	400 + 100	20 + 100	20 + 100			00.5 + 1
2.2 mA	10 – 20	150 + 5	50 + 5	50 + 5	7	500	0.05 + 0.1
	20 – 40	80 + 5	20 + 4	20 + 4			0.05 + 0.1
	40 – 1 k	30 + 3	4 + 1	10 + 2			0.05 + 0.1
	1 k – 5 k	50 + 20	10 + 100	20 + 100			0.25 + 0.5
	5 k – 10 k	400 + 100	50 + 400	50 + 400			00.5 + 1
22 mA	10 – 20	150 + 50	50 + 10	50 + 10	7	150	0.05 + 0.1
	20 – 40	80 + 50	20 + 10	20 + 10			0.05 + 0.1
	40 – 1 k	30 + 30	4 + 10	10 + 20			0.05 + 0.1
	1 k – 5 k	50 + 500	10 + 500	20 + 400			0.25 + 0.5
	5 k – 10 k	400 + 1000	50 + 1000	50 + 1000			00.5 + 1
	<b>Hz</b>	<b><math>\pm</math> (ppm output + <math>\mu\text{A}</math>)</b>	<b><math>\pm</math> (ppm output + <math>\mu\text{A}</math>) / <math>^\circ\text{C}</math></b>				
220 mA	10 – 20	150 + 0.5	50 + 0.05	50 + 0.05	7	15	0.05 + 10
	20 – 40	80 + 0.5	20 + 0.05	20 + 0.05			0.05 + 10
	40 – 1 k	30 + 0.3	4 + 0.1	10 + 0.1			0.05 + 10
	1 k – 5 k	50 + 3	10 + 2	20 + 2			0.25 + 50
	5 k – 10 k	400 + 5	50 + 5	50 + 5			00.5 + 100
2.2 A	20 – 1 k	50 + 5	4 + 1	10 + 1	1.4 <sup>[4]</sup>	0.5	0.5 + 100
	1 k – 5 k	80 + 20	10 + 5	20 + 5			0.3 + 500
	5 k – 10 k	800 + 50	50 + 10	50 + 10			0.1 + 1 mA

5725A Amplifier:							± (% output)
11 A	40 - 1 k	75 + 100	20 + 75	30 + 75	3	3	0.05 <sup>[5]</sup>
	1 k - 5 k	100 + 150	40 + 75	50 + 75			0.12 <sup>[5]</sup>
	5 k - 10 k	200 + 300	100 + 75	100 + 75			0.5 <sup>[5]</sup>

Notes:

Maximum output from 5720A terminals is 2.2 A. Uncertainty specifications for 220 µA and 2.2 mA ranges are increased by a factor of 1.3, plus 2 µA when supplied through 5725A terminals. Specifications are otherwise identical for all output locations.

- Stability specifications are included in the Absolute Uncertainty values for the primary specifications.
- Temperature coefficient is an adder to uncertainty specifications that does not apply unless operating more than ±5 °C from calibration temperature.
- For larger resistive loads multiply uncertainty specifications by:  $\left( \frac{\text{actual load}}{\text{maximum load for full accuracy}} \right)^2$
- 1.5 V compliance limit above 1 A. 5725A Amplifier may be used in range-lock mode down to 1 A.
- For resistive loads within rated compliance voltage limits.
- For outputs from the Aux Current terminals, the maximum resistive load for full accuracy is 1 kΩ. For larger resistive loads, multiply the uncertainty as described in Note 3.

**Minimum Output** .....9 µA for 220 µA range, 10 % on all other ranges. 1 A minimum for 5725A.

**Inductive Load Limits** .....400 µH (5700A/5720A, or 5725A). 20 µH for 5700A/5720A output >1 A.

**Power Factors** .....5700A/5720A, 0.9 to 1; 5725A, 0.1 to 1. Subject to compliance voltage limits.

**Frequency:**

**Range (Hz)** .....10.000 - 11.999, 12.00 - 119.99, 120.0 - 1199.9, 1.200 k - 10.000 k

    Uncertainty .....±0.01 %

    Resolution .....11,999 counts

**Settling Time** .....5 seconds for 5700A/5720A ranges; 6 seconds for 5725A 11 A range; +1 second for amplitude or frequency range change.

**Overshoot** .....<10 %

### 1-34. Wideband AC Voltage (Option 5700-03) Specifications

Specifications apply to the end of the cable and 50 Ω termination used for calibration.

Range		Resolution	Absolute Uncertainty ±5 °C from calibration temperature 30 Hz - 500 kHz			
Volts	dBm		24 Hours	90 Days	180 Days	1 Year
± (% output + μV)						
1.1 mV	-46	10 nV	0.4 + 0.4	0.5 + 0.4	0.6 + 0.4	0.8 + 2
3 mV	-37	10 nV	0.4 + 1	0.45 + 1	0.5 + 1	0.7 + 3
11 mV	-26	100 nV	0.2 + 4	0.35 + 4	0.5 + 4	0.7 + 8
33 mV	-17	100 nV	0.2 + 10	0.3 + 10	0.45 + 10	0.6 + 16
110 mV	-6.2	1 μV	0.2 + 40	0.3 + 40	0.45 + 40	0.6 + 40
330 mV	+3.4	1 μV	0.2 + 100	0.25 + 100	0.35 + 100	0.5 + 100
1.1 V	+14	10 μV	0.2 + 400	0.25 + 400	0.35 + 400	0.5 + 400
3.5 V	+24	10 μV	0.15 + 500	0.2 + 500	0.3 + 500	0.4 + 500

Frequency (Hz)	Frequency Resolution (Hz)	Amplitude Flatness, 1 kHz Reference Voltage Range			Temperature Coefficient ±ppm/°C	Settling Time To Full Accuracy (Seconds)	Harmonic Distortion (dB)
		1.1 mV	3 mV	>3 mV			
± (% output + floor indicated)							
10 - 30	0.01	0.3	0.3	0.3	100	7	-40
30 - 120	0.01	0.1	0.1	0.1	100	7	-40
120 - 1.2 k	0.1	0.1	0.1	0.1	100	5	-40
1.2 k - 12 k	1	0.1	0.1	0.1	100	5	-40
12 k - 120 k	10	0.1	0.1	0.1	100	5	-40
120 k - 1.2 M	100	0.2 + 3 μV	0.1 + 3 μV	0.1 + 3 μV	100	5	-40
1.2 M - 2 M	100 k	0.2 + 3 μV	0.1 + 3 μV	0.1 + 3 μV	100	0.5	-40
2 M - 10 M	100 k	0.4 + 3 μV	0.3 + 3 μV	0.2 + 3 μV	100	0.5	-40
10 M - 20 M	1 M	0.6 + 3 μV	0.5 + 3 μV	0.4 + 3 μV	150	0.5	-34
20 M - 30 M	1 M	1.5 + 15 μV	1.5 + 3 μV	1 + 3 μV	300	0.5	-34

**Additional Operating Information:**

dBm reference = 50 Ω

Range boundaries are at voltage points, dBm levels are approximate.

$$\text{dBm} = 10 \log \left( \frac{\text{Power}}{1\text{mW}} \right); 0.22361 \text{ V across } 50 \Omega = 1 \text{ mW or } 0 \text{ dBm}$$

**Minimum Output** ..... 300 μV (-57 dBm)

**Frequency Uncertainty** ..... ±0.01 %

**Frequency Resolution** ..... 11,999 counts to 1.1999 MHz, 119 counts to 30 MHz

**Overload Protection**..... A short circuit on the wideband output will not result in damage. After settling time, normal operation is restored upon removal.

**1-35. Auxiliary Amplifier Specifications**

For complete specifications, see the 5205A and 5220A Operators Manuals.

**5205A (220V - 1100 V ac, 0 V - 1100 V dc)**

Overshoot: < 10 %

Distortion (bandwidth 10 Hz - 1 MHz):

- 10 Hz - 20 kHz ..... 0.07 %
- 20 kHz - 50 kHz ..... 0.2 %
- 50 kHz - 100 kHz ..... 0.25 %

Frequency (Hz)	90 Day Accuracy at 23 ±5 °C ± (% output + % range)	Temperature Coefficient for 0 - 18 °C and 28 - 50 °C ± (ppm output + ppm range) / °C
0 dc	0.05 + 0.005	15 + 3
10 - 40	0.15 + 0.005	45 + 3
40 - 20 k	0.04 + 0.004	15 + 3
20 k - 50 k	0.08 + 0.006	50 + 10
50 k - 100 k	0.1 + 0.01	70 + 20

**5220A (AC Current, 180-day specifications):**

**Accuracy:**

- 20 Hz - 1 kHz ..... 0.07 % + 1 mA
- 1 kHz - 5 kHz ..... (0.07 % + 1mA) x frequency in kHz

**Temperature Coefficient (0 - 18 °C and 28 - 50 °C):**

(0.003 % + 100A) / °C

**Distortion (bandwidth 300 kHz):**

- 20 Hz - 1 kHz ..... 0.1% + 1 mA
- 1 kHz - 5 kHz ..... (0.1% + 1 mA) x frequency in kHz

Note: 5700A/5720A combined with 5220A is not specified for inductive loads.



## **Chapter 2**

# **Installation**

	<b>Title</b>	<b>Page</b>
2-1.	Introduction.....	2-3
2-2.	Unpacking and Inspection .....	2-3
2-3.	Service Information .....	2-4
2-4.	Contacting Fluke.....	2-4
2-5.	Placement and Rack Mounting .....	2-4
2-6.	Cooling Considerations.....	2-4
2-7.	Accessing the Fuse.....	2-5
2-8.	Selecting Line Voltage.....	2-6
2-9.	Connecting to Line Power .....	2-8
2-10.	Connecting a 5725A Amplifier.....	2-8
2-11.	Selecting Output Binding Posts .....	2-8



**⚠ Warning**

**The calibrator can supply lethal voltages to the front and rear binding posts. Read this chapter before operating the calibrator.**

**2-1. Introduction**

This chapter provides instructions for unpacking and installing the calibrator. The procedures for line voltage selection, fuse replacement, and connection to line power are provided here. Read this chapter before operating the calibrator.

Instructions for cable connections other than line power connection can be found in the following chapters of the manual:

- UUT (Unit Under Test) connections: Chapter 4
- IEEE-488 interface bus connection: Chapter 5
- RS-232-C serial interface connection: Chapter 6
- Option 5700-03 Wideband AC Module connection: Chapter 4
- Auxiliary amplifier connections: Chapter 4

**2-2. Unpacking and Inspection**

The calibrator is shipped in a container designed to prevent damage during shipping. Inspect the calibrator carefully for damage, and immediately report any damage to the shipper. Instructions for inspection and claims are included in the shipping container.

When you unpack the calibrator, check for all the standard equipment listed in Table 2-1 and check the shipping order for any additional items ordered. Refer to Chapter 8 for information about options and accessories. Report any shortage to the place of purchase or to the nearest Fluke Service Center. If performance tests are required for your acceptance procedures, refer to the *5700A/5720A Series II Service Manual* for instructions.

If you need to reship the calibrator, use the original container. If it is not available, you can order a new container from Fluke by indicating the calibrator’s model and serial number.

**Table 2-1. Standard Equipment**

<b>Item</b>	<b>Model or Part Number</b>
Calibrator	5700A/5720A Series II
Line Power Cord	See Table 2-2 and Figure 2-2
5700A/5720A Series II Manual Set	1668111
5700A/5720A Series II Operators Ref Guide	601648
5700A/5720A Series II Remote Prog Ref Guide	601655
5700A/5720A Series II Getting Started	1668111
5700A/5720A Series II Manual CD	1668127
Certificate of Calibration	No part number

### 2-3. Service Information

Each calibrator is warranted to the original purchaser for a period of one year beginning on the date received. The warranty is located at the front of this manual.

Service and technical advice for the calibrator is available at Fluke Service Centers. For a complete list of Fluke Service Centers, visit [www.fluke.com](http://www.fluke.com).

After-warranty service is available, but you may choose to repair the calibrator using the information in the Troubleshooting Chapter of the *5700A/5720A Series II Service Manual* and the Module Exchange Program. Refer to the Fluke catalog or contact a Service Center representative for the module exchange procedure.

### 2-4. Contacting Fluke

To order accessories, receive operating assistance, or get the location of the nearest Fluke distributor or Service Center, call:

USA: 1-888-44-FLUKE (1-888-443-5853)  
Canada: 1-800-36-FLUKE (1-800-363-5853)  
Europe: +31 402-675-200  
Japan: +81-3-3434-0181  
Singapore: +65-738-5655  
Anywhere in the world: +1-425-446-5500  
Or, visit Fluke's Web site at [www.fluke.com](http://www.fluke.com).

### 2-5. Placement and Rack Mounting

Place the calibrator on top of a bench or mounted in a standard-width, 24-inch (61-cm) deep equipment rack. For bench-top use, the calibrator is equipped with non-slipping, non-marring feet. To mount the calibrator in an equipment rack, use the Rack Mount Kit, Model Y-5737; instructions are included with the kit. For convenience, the rack mount instruction sheet can be stored in the binder of this manual.

### 2-6. Cooling Considerations

#### Caution

**Damage caused by overheating may occur if the area around the air intake is restricted, the intake air is too warm, or the air filter becomes clogged.**

A hidden but important feature of the calibrator is its internal cooling system. Baffles direct cooling air from the fans throughout the chassis to internally dissipate heat during operation. The accuracy and dependability of all internal parts of the calibrator are enhanced by maintaining the coolest possible internal temperature. By observing the following rules, you can lengthen the life of the calibrator and enhance its performance:

- The area around the air filter must be at least 3 inches from nearby walls or rack enclosures.
- The exhaust perforations on the sides of the calibrator must be clear of obstructions.
- The air entering the instrument must be room temperature. Make sure that exhaust from another instrument is not directed into the fan inlet.
- Clean the air filter every 30 days or more frequently if the calibrator is operated in a dusty environment. (Instructions for cleaning the air filter are in Chapter 7.)

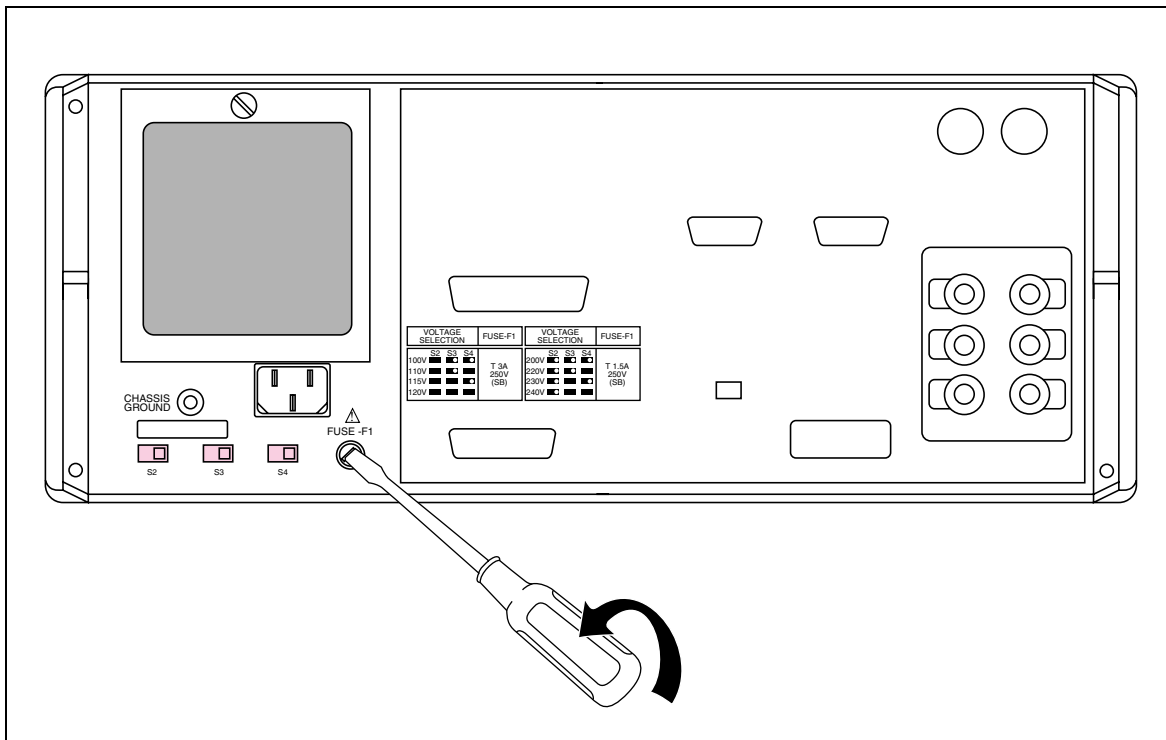
## 2-7. Accessing the Fuse

### Caution

**To prevent instrument damage, verify that the correct fuse is installed for the line voltage setting.**

The line power fuse is accessible on the rear panel. The fuse rating label to the right of the fuse holder (labeled F1) shows the correct replacement fuse rating for each line voltage setting. To check or replace the fuse, refer to Figure 2-1 and proceed as follows:

1. Disconnect line power.
2. Using a standard screwdriver, loosen the fuse holder by turning the slot labeled F1 until the cap and fuse pop free.
3. Replace the fuse and holder.



**Figure 2-1. Accessing the Fuse**

## 2-8. Selecting Line Voltage

The calibrator arrives from the factory configured for the line voltage normally appropriate for the country of purchase, or as specified at the time of your purchase order. The calibrator also comes with the appropriate line power plug for the country of purchase. If you need a different type, refer to Table 2-2 and Figure 2-2. They list and illustrate the line power plug types available from Fluke.

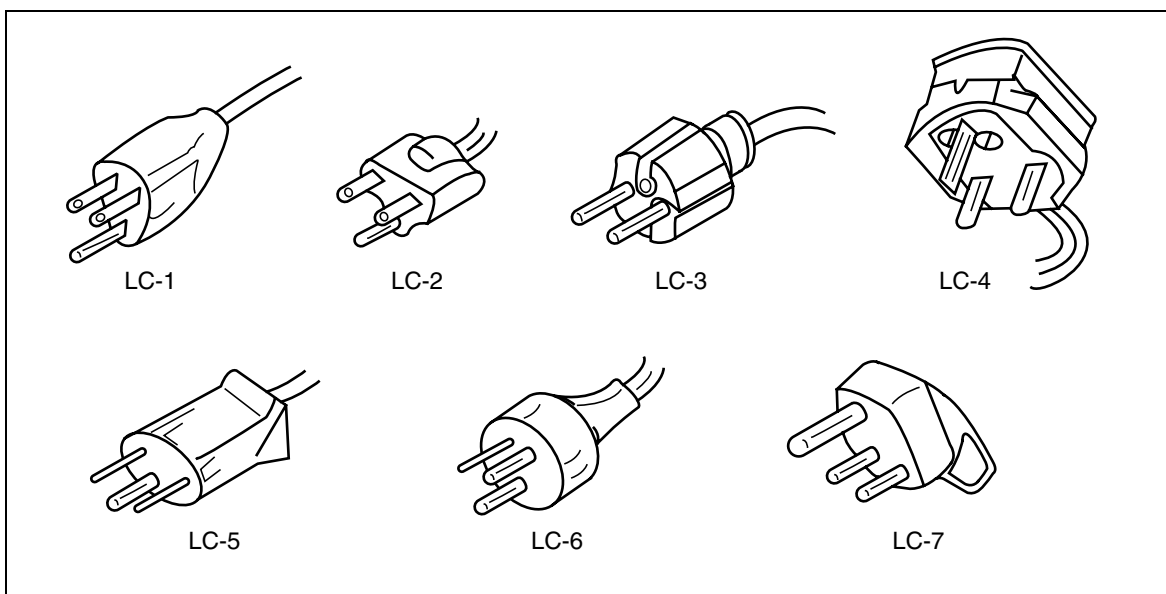
Check the line power label on the rear panel of the calibrator to verify that the line voltage matches local line power. Figure 2-3 shows the location of the line power label.

You can set the calibrator to operate from eight different nominal line voltages; each voltage setting has a voltage tolerance of  $\pm 10\%$ , and frequency range of 47 to 63 Hz. The line voltage switches are located on the bottom left side of the rear panel.

To change the line voltage setting, set the line voltage selection switches to the correct setting shown in Figure 2-3.

**Table 2-2. Line Power Cord Types Available from Fluke**

Type	Voltage/Current	Fluke Option Number
North America	120V/15A	LC-1
North America	240V/15A	LC-2
Universal Euro	220V/16A	LC-3
United Kingdom	240V/13A	LC-4
Switzerland	220V/10A	LC-5
Australia	240V/10A	LC-6
South Africa	240V/5A	LC-7



**Figure 2-2. Line Power Cord Types Available from Fluke**

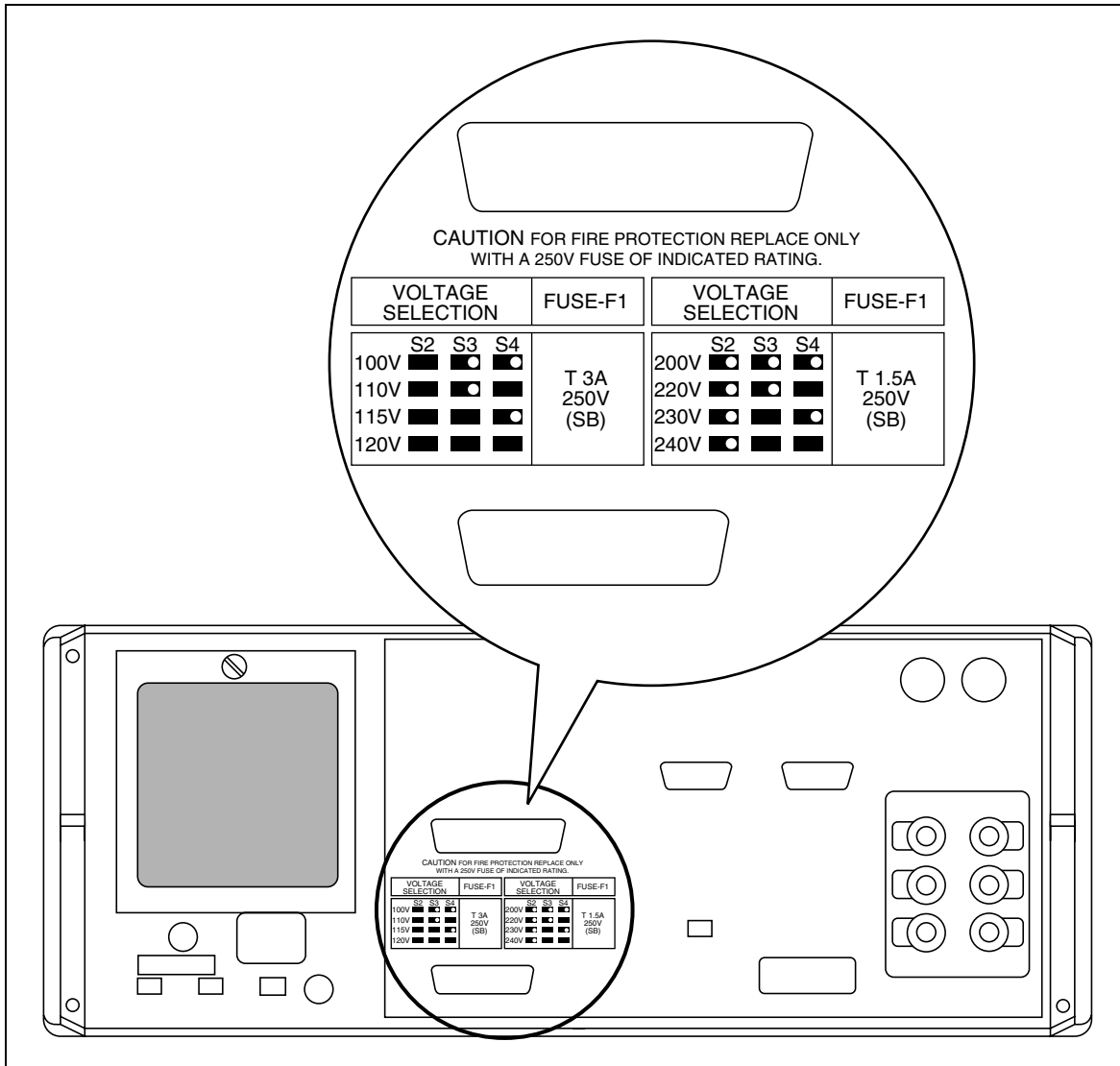


Figure 2-3. Line Power Label and Switch Location

## 2-9. Connecting to Line Power

### Warning

To avoid shock hazard, connect the factory supplied three-conductor line power cord to a properly grounded power outlet. Do not use a two-conductor adapter or extension cord; this will break the protective ground connection. If a two-conductor power cord must be used, a protective grounding wire must be connected between the ground terminal and earth ground before connecting the power cord or operating the instrument.

After you verify that the line voltage selection switches are set to the correct positions, verify that the correct fuse for that line voltage is installed. Connect the calibrator to a properly grounded three-prong outlet.

## 2-10. Connecting a 5725A Amplifier

The calibrator provides an interface connector for the Fluke 5725A amplifier. You designate the active amplifier for voltage and current boost in a setup menu. That procedure is located in the beginning of Chapter 4. Refer to the *5725A Instruction Manual* for the installation procedure.

## 2-11. Selecting Output Binding Posts

The calibrator is equipped with binding posts for OUTPUT, SENSE, and V GUARD (Voltage Guard) on the front and rear panels. Only one set of binding posts can be enabled at the same time. (GND binding posts on both front and rear are always connected to chassis ground.) The calibrator is shipped with the front panel binding posts enabled. The procedure to enable the rear panel binding posts involves opening the case of the calibrator, and repositioning a cable. This procedure is described in Chapter 4 of the *5700A/5720A Series II Service Manual*.

### Note

*A Type "N" connector for output from the Option 5700-03 Wideband AC Voltage Module is available only on the calibrator's front panel. A terminal for I GUARD is available only on the rear panel. (Connection to the I GUARD terminal is normally required only at low current levels in calibration systems with long cable runs.) Chapters 3 and 4 contain detailed information about the function and use of all binding posts.*

## **Chapter 3**

# **Features**

	<b>Title</b>	<b>Page</b>
3-1.	Introduction.....	3-3
3-2.	Front Panel Features .....	3-3
3-3.	Display Screen Saver.....	3-3
3-4.	Rear Panel Features .....	3-12
3-5.	Softkey Menu Tree .....	3-14



### **3-1. Introduction**

This chapter is a reference for the functions and locations of the calibrator's front and rear panel features, and provides brief but thorough descriptions of each features, for quick access. Please read this information before operating the calibrator. Front panel operating instructions for the calibrator are provided in Chapter 4, and remote operating instructions are provided in Chapter 5.

### **3-2. Front Panel Features**

Front panel features (including all controls, displays, indicators, and terminals) are shown in Figure 3-1. Each front panel feature is briefly described in Table 3-1.

### **3-3. Display Screen Saver**








The Control Display (described in Table 3-1) is equipped with a screen saver that lengthens the display's life when the front panel is not being used. The display becomes blank after 30 minutes of inactivity, unless it is one of the operating states that override the screen saver.

If the screen saver is in effect, you can restore the display by pressing CE. Pressing another key, or turning the knob, will also restore the display in addition to performing the command selected by the key or knob.

The screen saver will *not* go into effect after 30 minutes of inactivity if:

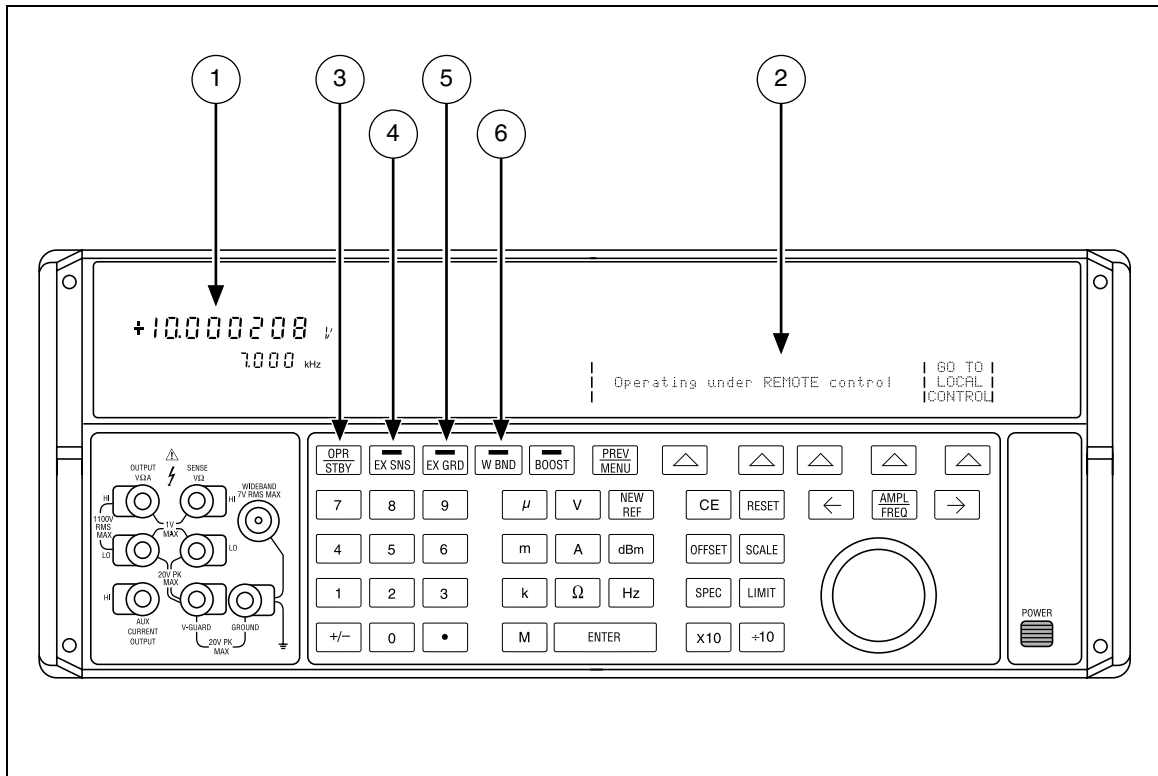
- the Setup Menu or any of its submenus are displayed
- the calibrator is being operated under remote control
- the calibrator is undergoing calibration or diagnostics
- an error message is displayed

Table 3-1. Front Panel Features

<p>① Output Display</p>	<p>A two-line vacuum-fluorescent display that shows output amplitude and frequency. The top line shows the active output value (or potential output value if in standby) using up to eight digits plus a polarity sign. The bottom line shows output frequency (or potential output frequency if the calibrator is in standby) using five digits. Following the digits on both lines of the Output Display are four unit annunciators. (Examples of units are: mV, <math>\mu</math>A, and kHz.) Annunciators below the amplitude line on the Output Display indicate the following active conditions:</p> <p>OPERATE Lit when an output is active at the binding posts or auxiliary amplifier</p> <p>STANDBY Lit when the calibrator is in standby</p> <p>ADDR Lit when the calibrator is addressed over the IEEE-488 interface</p> <p>∅-LCK Lit when the calibrator's output is phase locked to a signal at the rear panel PHASE LOCK IN connector</p> <p>∅-SHF Lit when the calibrator's output has a programmed phase difference with a signal at the rear panel VARIABLE PHASE OUT connector</p> <p>U (Unsettled.) When you change the output, this annunciator lights briefly until the output settles to within specification.</p>
<p>② Control Display</p>	<p>An alphanumeric vacuum-fluorescent display that shows data entries, UUT error adjustments, menus, and other prompts and messages. Each menu contains a set of softkey labels that identify the functions of the softkeys directly below them. The changing menus provide access to many different functions through the five softkeys plus the  key. (See Figure 3-3, Softkey Menu Tree.)</p>
<p>③  (Operate/Standby)</p>	<p>Toggles the calibrator between operate and standby modes. In standby mode, the OUTPUT binding posts are internally disconnected from the calibrator. The calibrator normally starts up in standby. Status is indicated by the lighted OPERATE or STANDBY annunciator above the OUTPUT binding posts. Pressing the  key does not change any other aspect of the calibrator's status. The calibrator automatically switches to standby when any of the following events occur:</p> <ul style="list-style-type: none"> <li>• The  key is pressed.</li> <li>• A voltage <math>\geq 22V</math> is selected when the previous output voltage was less than 22V.</li> <li>• The output location changes (e.g., an amplifier is selected). The exception to this is when the 5725A is selected for ac voltage or current, provided the calibrator's current output location is set to "5725A". In this case, the mode does not toggle.</li> <li>• The output function changes to voltage <math>&lt;22V</math>, ac voltage <math>&gt;22V</math>, dc voltage <math>&gt;22V</math>, dc current, ac current, or resistance. The exception is when switching between dc and ac current in 5100B emulation mode.</li> </ul>
<p>④  (External Sense)</p>	<p>Opens and closes an internal connection between the SENSE and OUTPUT binding posts. The calibrator powers up with SENSE and OUTPUT connected internally (the SENSE binding posts are open circuited), with  off. Pressing  disconnects the sense lines from the OUTPUT binding posts, and connects them to the SENSE binding posts internally.</p>













**Table 3-1. Front Panel Features (continued)**

	<p>External Sensing should be used in the dc voltage function when the UUT draws enough current to produce a significant voltage drop in the cables, and in the resistance function when the UUT has a four-wire ohms input and the calibrator is set to 100 kΩ or less. External sensing can also be used in conjunction with the two-wire compensation circuit to compensate for lead resistance at the UUT terminals. Refer to "When to use External Sensing," "Four-Wire vs. Two-Wire Resistance Connections," and "Cable Connections" in Chapter 4 for external sensing instructions.</p>
<p>5 EX GRD (External Guard)</p>	<p>Opens and closes an internal connection between V GUARD (voltage guard) and OUTPUT LO. The calibrator powers up with the voltage guard internally connected to OUTPUT LO and the EX GRD indicator off. Toggling EX GRD on disconnects OUTPUT LO from the voltage guard.</p> <p>The V GUARD binding post provides an external connection point for the voltage internal guard. For a UUT with floating inputs, the V GUARD should be connected to LO internally. (EX GRD is off.) For a UUT with a grounded input, the GUARD may be externally connected to the grounded UUT input. (EX GRD is on.) See Chapter 4 for instructions.</p>
<p>6 W BND (Wideband)</p>	<p>Toggles the Wideband AC Voltage Module (Option 5700A-03) and sets the calibrator to standby. When enabled, the ac voltage output from 10 Hz to 30 MHz is available at the front-panel coaxial connector. Wideband is disabled whenever W BND is toggled off or when another function (such as current) is selected. Chapter 4 contains more information.</p>



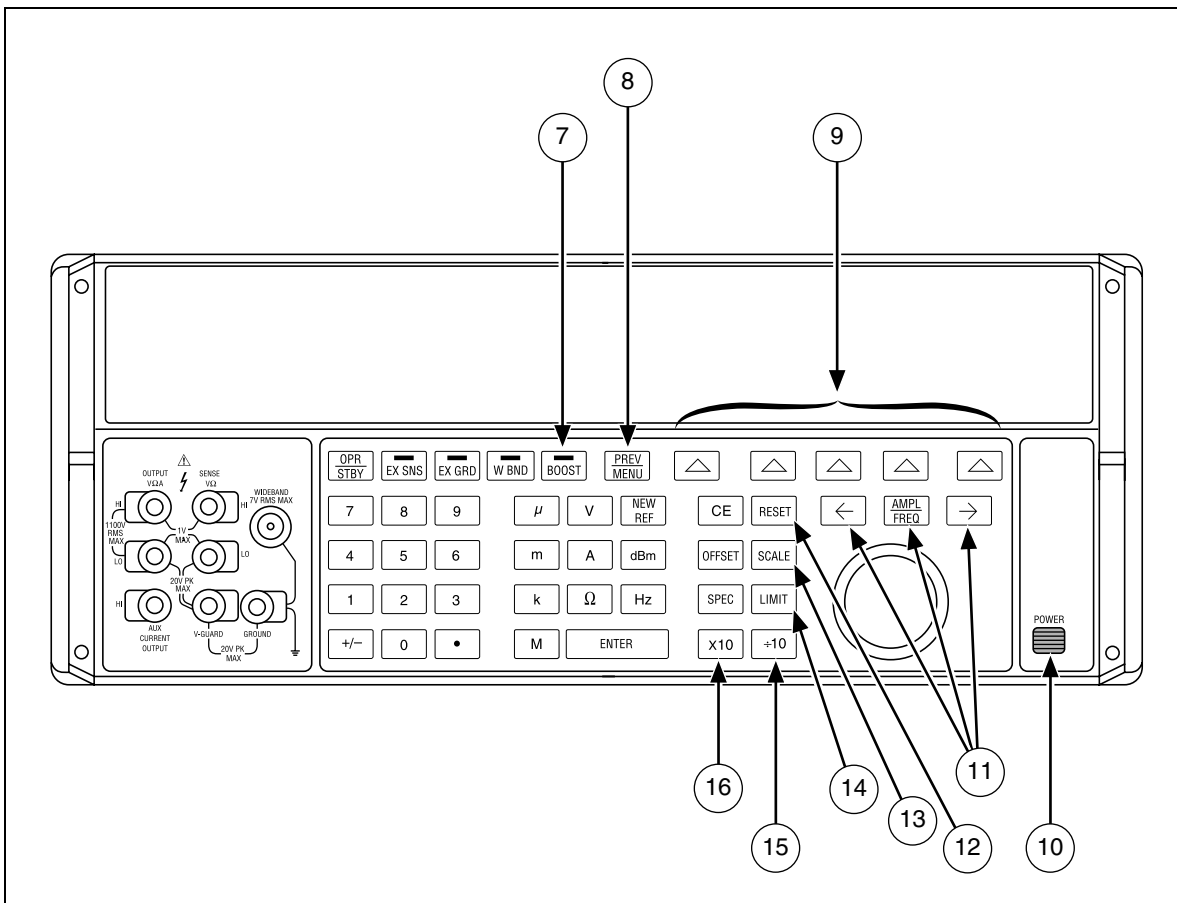
**Figure 3-1. Front Panel Features**

Table 3-1. Front Panel Features (continued)

<p>7</p> 	<p>Enables or disables output from an amplifier, when it would not otherwise be automatically selected. Sets the calibrator to standby if this selection moves the output location.</p> <p>When available, an amplifier is automatically selected for output settings that exceed the calibrator's capabilities but fall within the limits of the selected amplifier. The  key is only needed to activate an amplifier for an output setting that is available from either the calibrator or the amplifier. This allows you to take advantage of amplifier capabilities besides extended range, such as higher compliance voltage.</p> <p>For both voltage and current, the amplifier is assumed to be a 5725A unless another model is designated in the setup menus.</p>
<p>8</p>  (Previous Menu)	<p>The  softkey aborts the current operational state of the calibrator and recalls the previous set of menu choices. Some menus display a more specific label for this key, such as "DONE Setting Up".</p>
<p>9</p> <p>Softkeys</p>	<p>The functions of the five unlabeled softkeys are identified by labels on the Control Display directly above each key. The functions change during operation so that many different functions are accessible through these keys. A group of softkey labels is called a menu. A group of interconnected menus is called a menu tree. Figure 3-3 shows the menu tree for the calibrator.</p>
<p>10</p> <p>Power Switch</p>	<p>Turns the power on and off. The switch remains locked inwards when the power is on. Pushing the switch again unlocks it and turns the power off.</p>
<p>11</p>   	<p>The output adjustment controls. If any of these keys are pressed or the knob is rotated, a digit on the Output Display becomes highlighted and the output increments or decrements as the knob is rotated. If a digit rolls past 0 or 9, the digit to its left or right is carried. An error display appears on the Control Display, showing the difference between the original (reference) output and the new (adjusted) output.</p> <p>The  and  keys adjust the magnitude of changes by moving the highlighted digit. In the ac functions, the  key toggles between voltage or current to frequency. For voltage and current outputs, the knob and arrow keys are used to adjust output until the UUT reads correctly. The error display then displays UUT deviation from the reference.</p> <p>Since resistances are not adjustable, the knob and arrow keys adjust a value on the Control Display to equal the UUT reading. Refer to "Error Mode Operation" in Chapter 4 for details of entering, operating, and exiting Error Mode.</p> <p>The rotary knob is also used to adjust the phase of the ac output signal with respect to a signal at the VARIABLE PHASE OUT connector after the "Phase Ctrls Menu" softkey is pressed.</p>
<p>12</p> 	<p>Aborts the current operating state of the calibrator and returns it to its power-up default state.  has no effect when operating under remote control.</p>

**Table 3-1. Front Panel Features (continued)**

<p>⑬ SCALE</p>	<p>Identifies a UUT full-scale endpoint for checking linearity and does not change the output. If the output was adjusted with the rotary knob, subsequent keyed-in output values are multiplied by a scale factor. Scaling is deactivated by pressing <b>SCALE</b> again, or by selecting another function. Scaling is not available for resistance outputs. See "Linearity Checking Using Offset and Scale" in Chapter 4 for details.</p>
<p>⑭ LIMIT</p>	<p>Calls up a menu that allows you to specify limits beyond which the calibrator will not operate, to protect your test equipment and personnel.</p>
<p>⑮ +10</p>	<p>Immediately changes the output to one tenth the reference value (not necessarily the present output value) if the value is within performance limits.</p>
<p>⑯ X10</p>	<p>Immediately changes the output to ten times the reference value (not necessarily the present output value) if the value is within performance limits. This key sets the calibrator to standby if this change is from below 22V to 22V or more.</p>



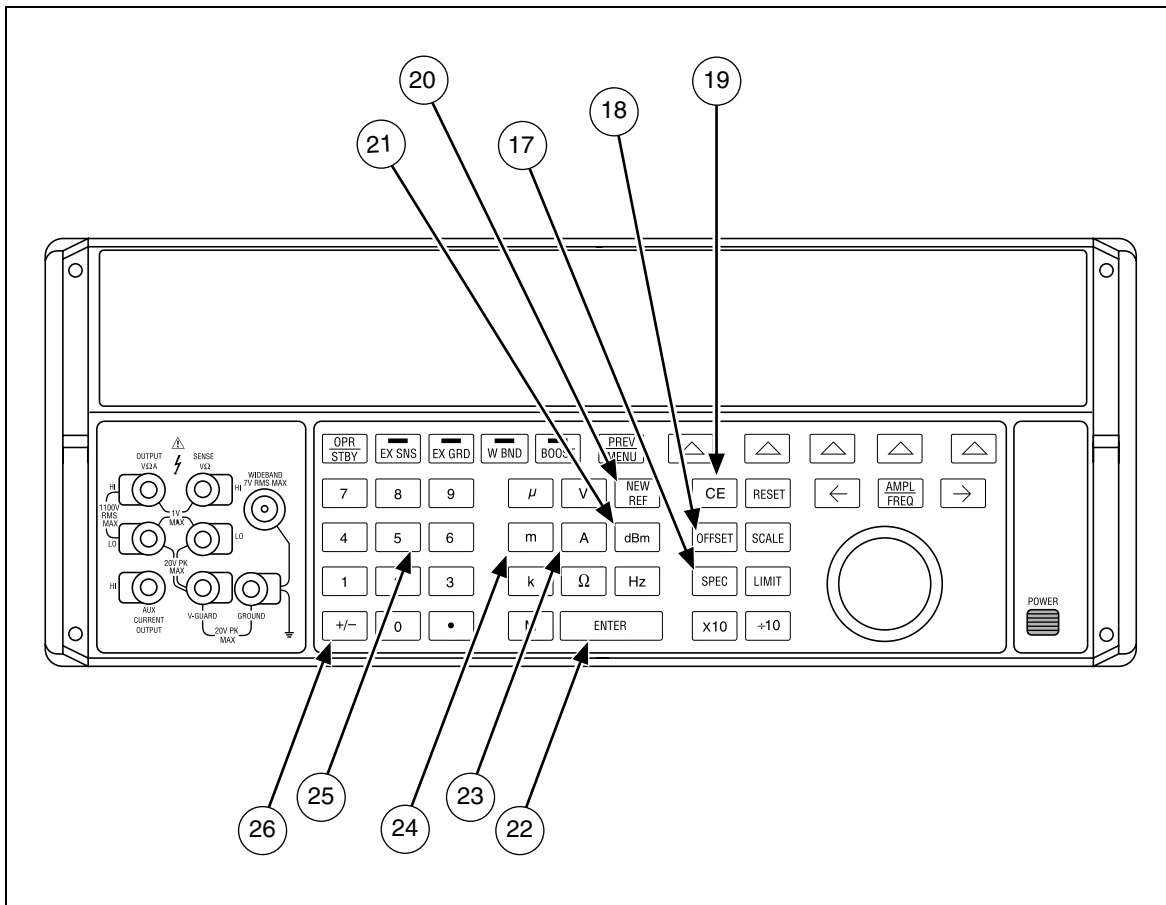
**Figure 3-1. Front Panel Features (continued)**

Table 3-1. Front Panel Features (continued)

<p>17</p> <p>SPEC (Specification)</p>	<p>Causes the calibrator to compute and display its absolute uncertainty for the present output setting for the calibration interval selected in the setup menus.</p>
<p>18</p> <p>OFFSET</p>	<p>Identifies a UUT zero-scale endpoint and does not change the output. Subsequent keyed-in output values have the offset value (the calibrator's output value when OFFSET was pressed) added to them. Offset mode is deactivated by pressing OFFSET again or by selecting another function. Offsets are available for dc outputs only. See "Programming an OFFSET" in Chapter 4 for details.</p>
<p>19</p> <p>CE (Clear Entry)</p>	<p>Clears a partially completed keypad entry from the Control Display or clears an error message that requires acknowledgement. If there is a partially completed entry when CE is pressed, the output is unaffected.</p>
<p>20</p> <p>NEW REF</p>	<p>Only active during error mode operation, the NEW REF key establishes the present output value as a new reference for meter error computation.</p>
<p>21</p> <p>dBm</p>	<p>When in the ac volts or wideband function, and if no entry is in progress, the dBm key shows the equivalent dBm output on the Control Display. For the ac voltage function, dBm is calculated for a 600Ω load. For the wideband function, dBm is calculated for a 50Ω resistive termination at the end of a 3-foot 50Ω coaxial cable.</p> <p>The formula for computing dBm is: <math>10 * \log(\text{power in mW})</math></p> <p>Examples:</p> <p>For 3.0V into a 600Ω load, <math>\text{dBm} = 10 \log(15.000) = 11.7609 \text{ dBm}</math></p> <p>For 3.0V into a 50Ω load, <math>\text{dBm} = 10 \log(180.000) = 22.5527 \text{ dBm}</math></p>
<p>22</p> <p>ENTER</p>	<p>The ENTER key loads an output value that was entered into the Control Display into the calibrator. If you press ENTER without identifying the units for the entry, the calibrator keeps the most recently used units. The multipliers are not saved. For example, if the most recently entered value was 1 mV, then simply entering 10 produces an output of 10V. (The "V" units were saved from the last entry, but not the multiplier, "m".)</p> <p>Another function of the ENTER key is to recall the currently-programmed reference value during error mode operation. Refer to "Error Mode Operation" in Chapter 4 for details.</p>
<p>23</p> <p>Output Function Keys</p>	<p>Select the output function. The output functions are:</p> <ul style="list-style-type: none"> <li>dBm Decibels relative to 1 mW</li> <li>V Voltage</li> <li>A Current</li> <li>Ω Resistance</li> <li>Hz Frequency</li> </ul> <p>When Hz is entered, the calibrator automatically switches to ac. When a new signed (+ or -) output value is entered without specifying Hz, the calibrator automatically switches back to dc.</p>




**Table 3-1. Front Panel Features (continued)**

<p>(24) Multiplier Keys</p>	<p>Select output value multipliers. For example, if you enter <b>3</b> <b>3</b> <b>m</b> <b>V</b>, then <b>ENTER</b>, the calibrator output value is 33 mV. The multiplier keys are:</p> <p><b>μ</b> micro (<math>10^{-6}</math>)</p> <p><b>m</b> milli (<math>10^{-3}</math>)</p> <p><b>k</b> kilo (<math>10^3</math>)</p> <p><b>M</b> mega (<math>10^6</math>)</p>
<p>(25) Numeric Keypad</p>	<p>Contains number keys for keying in the output amplitude and frequency, as well as other data such as the time and date. To enter a value, press the digits of the output value, a multiplier key if necessary, and an output function key; then press <b>ENTER</b>. For example, for an output of 20 mV, press <b>2</b> <b>0</b> <b>m</b> <b>V</b>, then <b>ENTER</b>.</p>
<p>(26) <b>+/-</b></p>	<p>If the output function is dc voltage, current, ac voltage entered in dBm, or a wideband output entered in dBm, pressing <b>+/-</b> <b>ENTER</b> toggles the polarity of the output. If the output function is ac voltage or current, pressing <b>+/-</b>; then <b>ENTER</b> changes the output to dc.</p>



**Figure 3-1. Front Panel Features (continued)**

Table 3-1. Front Panel Features (continued)

<p>②7 WIDEBAND Connector</p>	<p>A Type "N" connector that provides a connection point for output from the Option 5700A-03 Wideband AC Module. Wideband output specifications are stated for output levels present at the end of its 3-foot 50Ω coaxial cable terminated into a 50Ω purely resistive load. The connector shell is connected to chassis ground. Refer to Chapter 4 for connecting and operating instructions for the wideband module.</p>
<p>②8 GND Binding Post</p>	<p>If the calibrator is the location of the ground reference point in a system, the GND binding post can be used for connecting other instruments to earth ground. (The chassis is normally connected to earth ground through the three-conductor line cord instead of through the earth ground binding post.) Refer to "Cable Connections" in Chapter 4 for details. Included with the calibrator is a brass strap that connects GND to V GUARD.</p>
<p>②9 V GUARD Binding Post</p>	<p>Provides an external connection point for the internal voltage guard. For a UUT with floating (ungrounded) inputs, the V GUARD should be connected to LO internally ( off). For a UUT with a grounded input, the V GUARD must be externally connected to the grounded UUT input ( on). The maximum allowable potential between the V GUARD connector and chassis ground is 20V peak. Refer to "When to use External Voltage Guard" and "Cable Connections" in Chapter 4 for details.</p>
<p>③0 SENSE Binding Posts</p>	<p>Used in the resistance and voltage functions for sensing at the UUT after you have selected external sense by pressing  or by remote command.</p> <p>External Sensing should be used in the dc voltage function when the UUT draws enough current to produce a significant voltage drop in the cables, and in the resistance function when the UUT has a four-wire ohms input and the calibrator is set to 100 kΩ or less. External sensing can also be used in the two-wire ohms function to allow the two-wire compensation circuitry to the UUT terminals. Refer to "When to use External Sensing," "Four-Wire vs. Two-Wire Resistance Connections," and "Cable Connections" in Chapter 4 for external sensing instructions and illustrations of SENSE connections.</p>
<p>③1 OUTPUT Binding Posts</p>	<p>Provide connection points for ac and dc current and voltage output, as well as resistance. The function of each OUTPUT binding post is defined below:</p> <p><b>LO</b></p> <p>The common binding post for all output functions including 5725A amplified voltage output, but not Option 5700A-03 Wideband AC or other auxiliary amplifier output.</p> <p><b>HI</b></p> <p>The active binding post for all output functions including 5725A amplified voltage output, but not Option 5700A-03 Wideband AC or other auxiliary amplifier output.</p> <p><b>AUX CURRENT OUTPUT</b></p> <p>An optional active binding post for current. It is convenient to use the AUX CURRENT OUTPUT binding post when calibrating a UUT with a separate current input terminal. Refer to "Connecting the calibrator to the UUT" in Chapter 4 for instructions for using this binding post.</p>

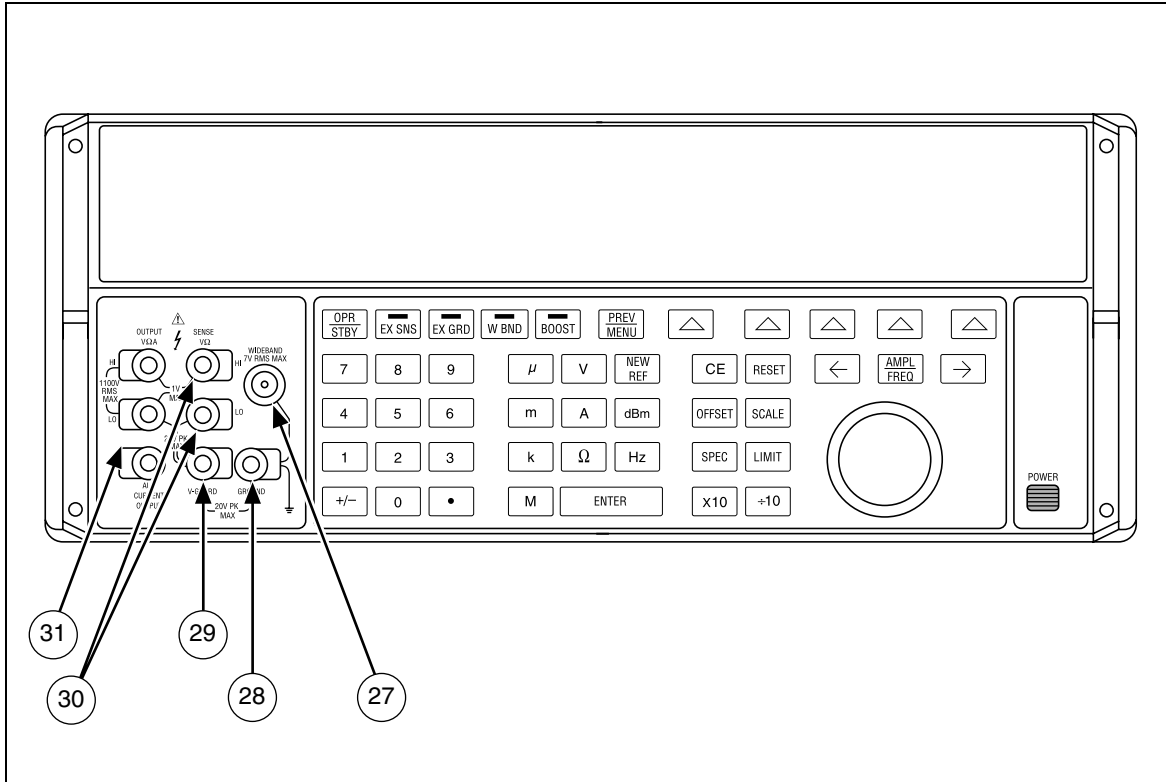


Figure 3-1. Front Panel Features (continued)

### 3-4. Rear Panel Features

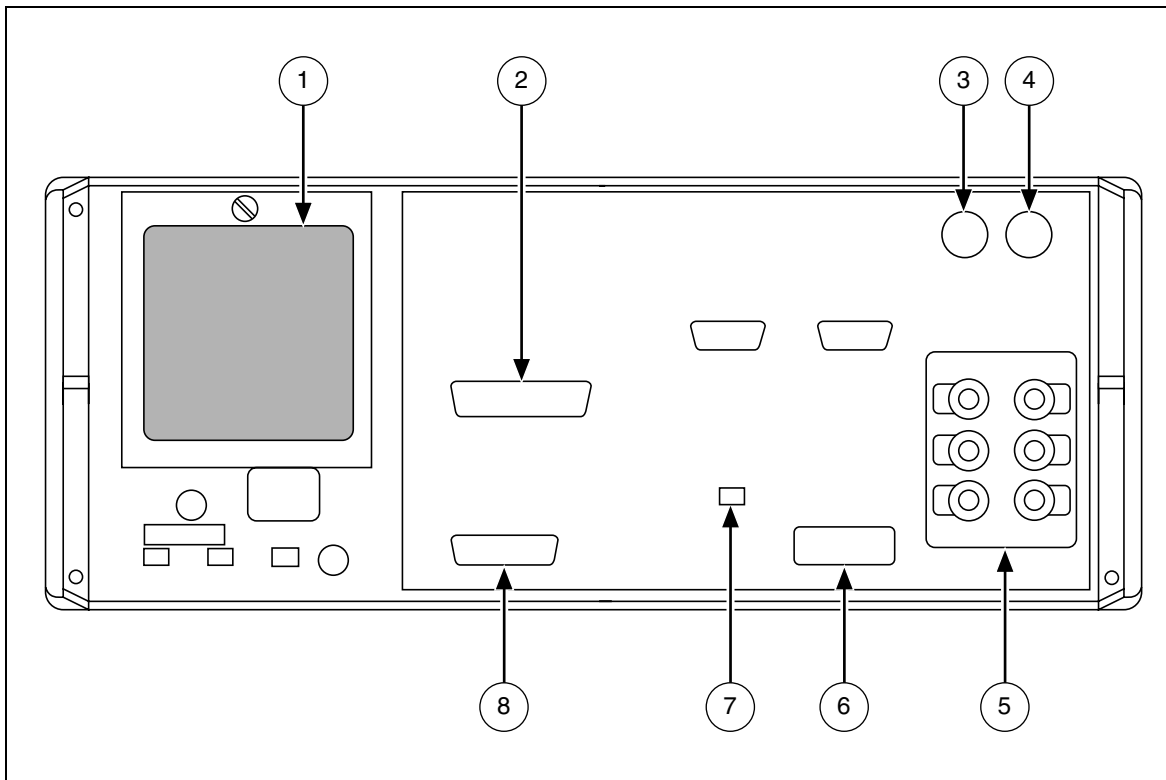
Rear panel features (including all terminals, sockets, and connectors) are shown in Figure 3-2. Each rear panel feature is briefly described in Table 3-2.

**Table 3-2. Rear Panel Features**

<p>① Fan Filter</p>	<p>The filter covers the air intake to keep dust and debris out of chassis air baffles. Fans inside the calibrator provide a constant cooling air flow throughout the chassis. Circuitry inside the calibrator monitors correct operation of the internal fans.</p>
<p>② 5725A AMPLIFIER Connector</p>	<p>Provides the analog and digital interface for the Fluke 5725A Amplifier. After connecting the 5725A to the 5725A AMPLIFIER connector, you control the 5725A from the calibrator's front panel or by remote commands. Refer to "Using an Auxiliary Amplifier" in Chapter 4 for details.</p>
<p>③ VARIABLE PHASE OUT BNC Connector</p>	<p>Provides access to a variable-phase nominal 2.5V rms sine-wave signal, intended for a 3 k<math>\Omega</math> load. The phase of this signal can be adjusted using the arrow keys and rotary knob (or by remote commands) to lead or lag the main calibrator output signal by up to 180 degrees. The connector shell is not connected directly to chassis ground. It is connected internally to the OUTPUT LO binding post. The maximum allowable potential between the connector shell and chassis ground is 20V peak. Refer to "Variable Phase Output" in Chapter 4 for details.</p>
<p>④ PHASE LOCK IN BNC Connector</p>	<p>Provides the input for an external signal onto which the calibrator can be phase locked. (1 to 10V rms, 10 k<math>\Omega</math> input impedance.) The connector shell is not connected directly to chassis ground. It is connected internally to the OUTPUT LO binding post. The maximum allowable potential between the connector shell and chassis ground is 20V peak. Refer to "Phase Locking to an External Signal," in Chapter 4 for details.</p>
<p>⑤ Rear Panel Binding Posts</p>	<p>The rear-panel OUTPUT, SENSE, and V GUARD and I GUARD binding posts are alternative connections to the UUT. An internal cable enables either the front or rear binding posts. The procedure to disable the front panel binding posts and enable the rear panel binding posts involves opening the cover of the calibrator and is described in Chapter 4 of the <i>5700A/5720A Series II Service Manual</i>.</p> <p>The I GUARD binding post provides an external connection point for the internal current guard. The current guard is used when the calibrator is supplying low-level ac current through a long cable to remove errors introduced by leakage through the cable capacitance. The I GUARD binding post is available on the rear panel where it is convenient for system applications. Refer to "When to use the Current Guard" in Chapter 4 for details.</p> <p>AUX CURRENT OUTPUT is not available on the rear panel binding posts.</p>

**Table 3-2. Rear Panel Features (continued)**

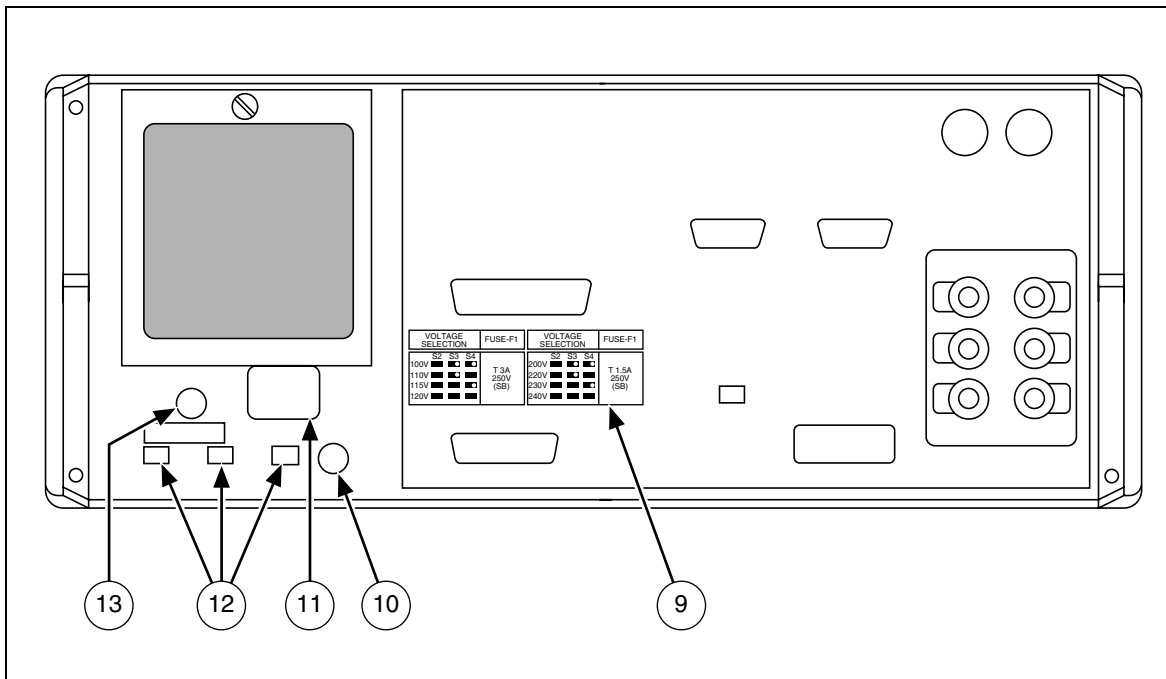
<p>⑥ IEEE-488 Connector</p>	<p>A standard interface connector for operating the calibrator in remote control as a Talker or Listener on the IEEE-488 Bus. Refer to Chapter 5 for bus connection and remote programming instructions.</p>
<p>⑦ CALIBRATION Switch</p>	<p>A slide switch that write enables and disables the nonvolatile memory that stores calibration constants, dates, and setup parameter settings. Switching to ENABLE write enables the memory, and switching to NORMAL protects data in memory from being overwritten. The switch must be in the ENABLE position to set the clock. The switch is recessed to allow the metrologist to cover it with a calibration sticker to guarantee calibrator integrity.</p>
<p>⑧ RS 232C Connector</p>	<p>A male (DTE) serial port connector for transmitting internal calibration constant data to a printer, monitor, or host computer, and for remote control of the calibrator. Chapter 6 describes proper cabling, how to set up the serial interface, and how to transmit data from the calibrator. Chapter 5 describes how to use the serial interface for remote control.</p>



**Figure 3-2. Rear Panel Features**

**Table 3-2. Rear Panel Features (continued)**

<p>⑨ Line Voltage Switch and Fuse Rating Label</p>	<p>Shows the various settings of the line voltage switches, and the correct replacement fuse ratings for fuse F1 for operating voltages of 110 (90-132) and 220 (180-264) V ac. Refer to "Accessing the Fuse" in Chapter 2 for the fuse replacement procedure.</p>
<p>⑩ F1 Fuseholder</p>	<p>The line power fuse. Refer to "Accessing the Fuse" in Chapter 2 for fuse rating information and the fuse replacement procedure.</p>
<p>⑪ AC PWR INPUT Connector</p>	<p>A grounded male three-prong connector that accepts the line power cord.</p>
<p>⑫ Line Voltage Selection Switches</p>	<p>Select the operating line voltage. Refer to "Selecting Line Voltage" in Chapter 2 for how to select operating line voltage.</p>
<p>⑬ CHASSIS GROUND Binding Post</p>	<p>A binding post that is internally grounded to the chassis. If the calibrator is the location of the ground reference point in a system, this binding post can be used for connecting other instruments to earth ground. (The chassis is normally connected to earth ground through the three-conductor line cord instead of through the earth ground binding post.) Refer to "Connecting to the UUT" in Chapter 4 for details.</p>



**Figure 3-2. Front Panel Features (continued)**

### 3-5. Softkey Menu Tree

The functions of the six softkeys described under “Front Panel Features”, are represented by menus containing labels displayed directly above each key. These functions change whenever you access a new menu. Figure 3-3 shows the hierarchy of all the menus available for the calibrator.

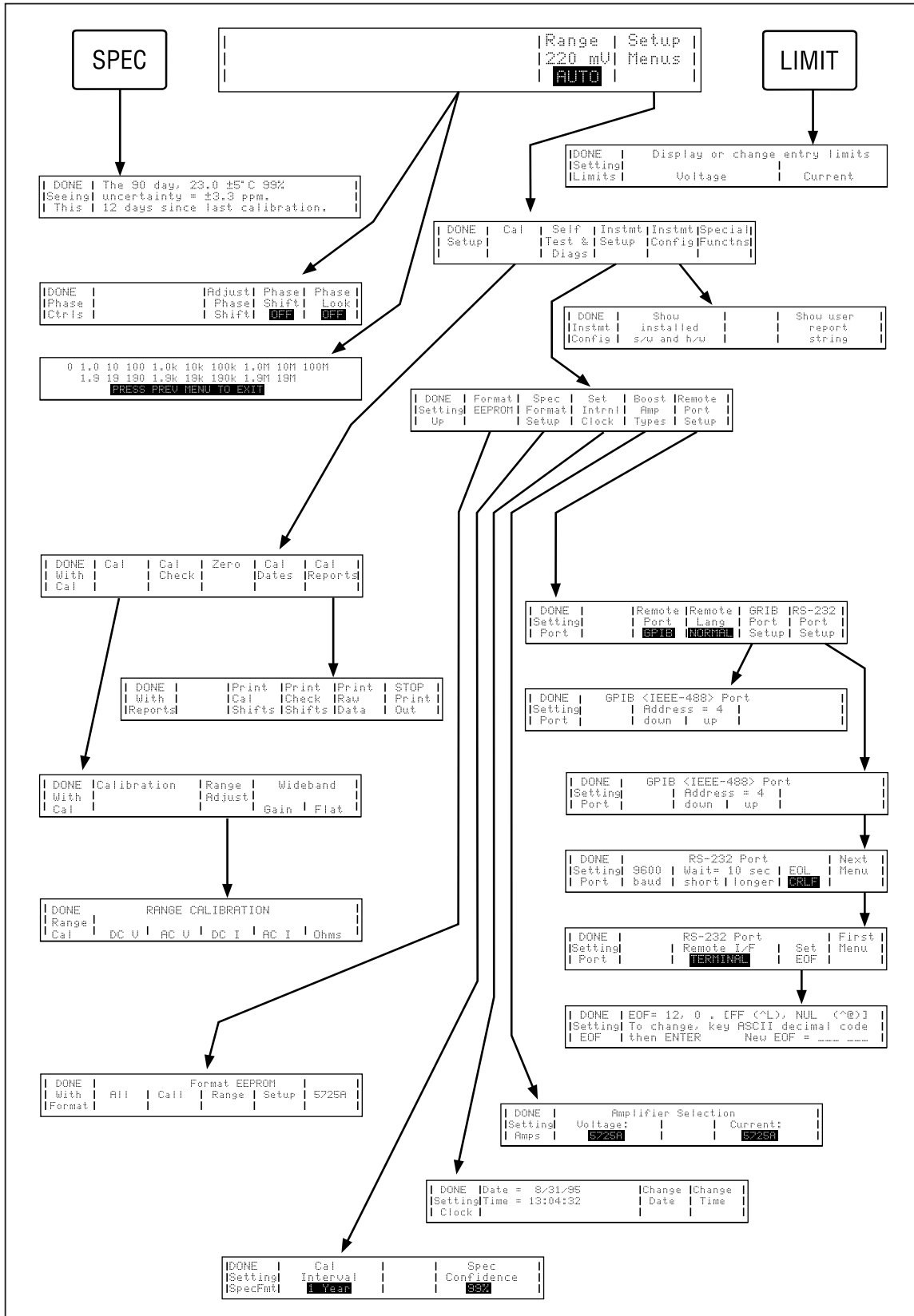


Figure 3-3. Softkey Menu Tree



# **Chapter 4**

## **Front Panel Operation**

	<b>Title</b>	<b>Page</b>
4-1.	Introduction.....	4-3
4-2.	Powering on the Calibrator.....	4-4
4-3.	Warm Up.....	4-4
4-4.	DC Zeros.....	4-5
4-5.	Executing DC Zeros .....	4-5
4-6.	DC Zeros Reminder.....	4-5
4-7.	The Setup Menu.....	4-6
4-8.	Instrument Setup.....	4-7
4-9.	Format EEPROM Menu .....	4-7
4-10.	Spec Format Setup Menu .....	4-8
4-11.	Setting the Internal Clock/Calendar .....	4-9
4-12.	Selecting Amplifiers.....	4-10
4-13.	Checking the Instrument Configuration .....	4-11
4-14.	Special Functions Menu .....	4-12
4-15.	Resetting the Calibrator.....	4-12
4-16.	Operate and Standby Modes.....	4-13
4-17.	Connecting the Calibrator to a UUT.....	4-13
4-18.	Recommended Cable and Connector Types.....	4-13
4-19.	When to Use External Sensing .....	4-14
4-20.	When to Use the External Voltage Guard .....	4-15
4-21.	When to Use the Current Guard.....	4-15
4-22.	Four-Wire Vs. Two-Wire Resistance Connections .....	4-16
4-23.	Cable Connection Instructions .....	4-16
4-24.	Setting the Output.....	4-22
4-25.	DC Voltage Output.....	4-24
4-26.	AC Voltage Output.....	4-25
4-27.	DC Current Output .....	4-27
4-28.	AC Current Output .....	4-28
4-29.	Resistance Output.....	4-30



4-30.	Wideband AC Voltage Output (Option 5700A-03) .....	4-32
4-31.	Variable Phase Output .....	4-34
4-32.	Phase Locking to an External Signal .....	4-35
4-33.	Using an Auxiliary Amplifier .....	4-36
4-34.	5725A Amplifier Output .....	4-37
4-35.	Checking the Calibrator's Uncertainty Specification .....	4-38
4-36.	Error Mode Operation .....	4-38
4-37.	Error Mode Overview .....	4-39
4-38.	Entering Error Mode .....	4-39
4-39.	Exiting Error Mode .....	4-39
4-40.	Using Error Mode .....	4-40
4-41.	Reading the UUT Error: AC and DC Voltage and Current Output ..	4-40
4-42.	Reading the UUT Error: Resistance Output .....	4-41
4-43.	Introduction to Offset, Scale, and Linearity Errors .....	4-42
4-44.	Offset Error .....	4-42
4-45.	Scale Error .....	4-43
4-46.	Linearity Error .....	4-44
4-47.	Combining the Error Types .....	4-44
4-48.	Programming an Offset .....	4-45
4-49.	Programming a Scale Factor .....	4-46
4-50.	Linearity Checking Using Offset and Scale .....	4-47
4-51.	Setting Output Limits .....	4-50
4-52.	Setting Voltage and Current Limits .....	4-50
4-53.	Sample Applications .....	4-51
4-54.	Calibrating Fluke 70 Series Multimeter .....	4-51
4-55.	Cables .....	4-52
4-56.	Guarding .....	4-52
4-57.	Sensing .....	4-52
4-58.	Testing the Meter .....	4-53
4-59.	Calibrating the Meter .....	4-54
4-60.	Calibrating a Fluke Model 8840A Series Digital Multimeter .....	4-56
4-61.	Cables .....	4-56
4-62.	Guarding .....	4-56
4-63.	Sensing .....	4-58
4-64.	Basic Calibration Procedure .....	4-58
4-65.	Calibration Setup Procedure .....	4-58
4-66.	A/D Calibration .....	4-59
4-67.	Offset and Gain Calibration .....	4-60
4-68.	High Frequency AC Calibration .....	4-62
4-69.	Performing A Wideband Flatness Test .....	4-63

## 4-1. Introduction

This chapter provides instructions for operating the calibrator from the front panel, which includes all aspects of setting up and configuring the calibrator. Sample applications are included that describe how to calibrate a Fluke 70 Series Multimeter and an 8840A Series Digital Multimeter. Descriptions and instructions for programming offsets, scale factors, and linearity checks are also provided.

Before you begin following the procedures in this chapter, you should be familiar with the front panel controls, displays, and terminals, which are identified and described in detail in Chapter 3. Once you are familiar with the front panel, be sure to warm up the calibrator and ensure its dc zeros calibration, in accordance with the instructions at the beginning of this chapter. For information on using remote commands to operate the calibrator, refer to Chapter 5.

### **⚠ Warning**

**The calibrator is capable of supplying lethal voltages. Do not make connections to the output terminals when any voltage is present. Placing the instrument in standby may not be enough to avoid shock hazard, since the  key could be pressed accidentally. Press  and verify that standby is lit before making connections to the output terminals.**

## 4-2. Powering on the Calibrator

### ⚠ Warning

To avoid electric shock, make sure the calibrator is safely grounded as described in Chapter 2.

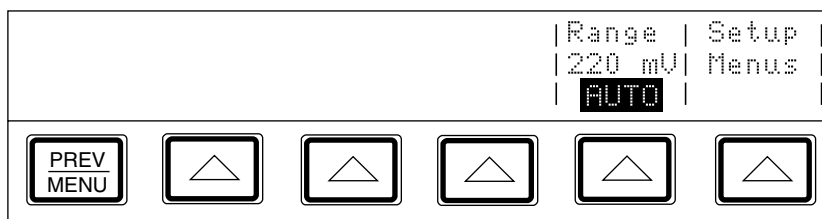
### Caution

Before turning the calibrator on, make sure that the line voltage selection switches are set properly for your line voltage. Refer to Figure 2-3 or to the line voltage switch label and check the line voltage now if you have not already done so.

When you power on the calibrator, the Control Display appears as shown below and then displays a series of tests, as the calibrator performs self-tests. If a self test fails, a prompt on the Control Display identifies the failed test and lets you choose whether to continue self testing or stop and run self diagnostics. For information about self-diagnostics, refer to Chapter 3 of the *5700A/5720A Series II Service Manual*.



After the calibrator passes its self-tests, it powers up to 0V dc in standby, configured for internal sensing and internal guard, ready to accept an entry from the keypad. The Control Display now appears as shown below:



## 4-3. Warm Up

The calibrator must always be warmed up, to allow the environmentally controlled components inside to stabilize, and to ensure that it meets or exceeds the specifications listed in Chapter 1. Sufficient warmup times are as follows:


- If the calibrator has been powered off for one hour or more, allow at least 30 minutes of warmup time.
- If the calibrator has been powered off for a length of time less than one hour, allow it to warm up for at least twice the length of time it was turned off. For example, if it has been turned off for 10 minutes, allow at least 20 minutes of warmup time.

#### 4-4. DC Zeros

DC zeros is a quick, automatic process that removes any offset error on the 11V and 2.2V ranges, and removes offset and gain errors on the 220 mV range. If a 5725A Amplifier is attached, it also zeros the 11A dc range. This process takes about 2.5 minutes (plus an additional 30 seconds for the 5725A).

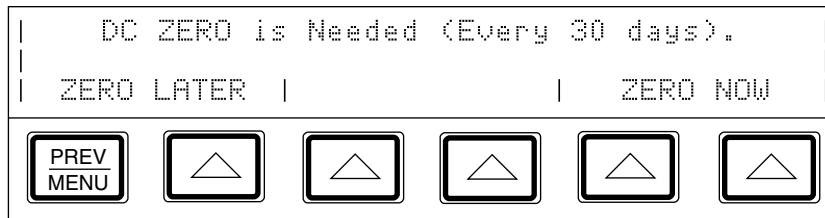
#### 4-5. Executing DC Zeros


To execute dc zeros, proceed as follows from the power-up state:

1. Press the following sequence of softkeys:  
“Setup Menus” → “Cal” → “Zero”
2. When the process is finished, a message appears that tells you to press any key to continue. Press any key to exit the dc zeros display.
3. To return to normal operation, press  twice.

#### 4-6. DC Zeros Reminder

Specifications require that dc zeros be executed at least every 30 days. If the 30-day time period elapses and dc zeros is not performed, the following message appears on the display when the calibrator is powered on, or reset.



To override the message and perform dc zeros at a more convenient time, press the softkey under ZERO LATER (the softkey next to ). To perform dc zero at this time, press one of the softkeys under ZERO NOW.

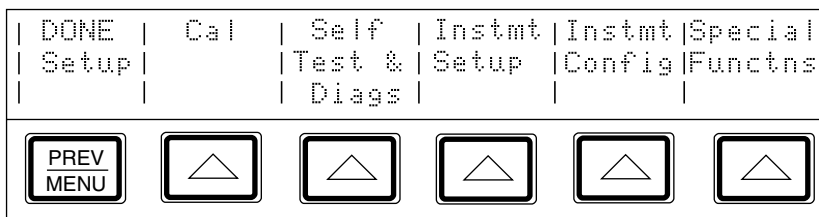
*Note*

*If you receive this message after powering on the calibrator, allow the calibrator to warm up before executing dc zeros. Otherwise an error message appears indicating that the calibrator is not warmed up. To ensure the best performance, the warmup period should be completed.*

## 4-7. The Setup Menu

Through the setup menu you have access to various operations and changeable parameters. Once you set a parameter, it is saved in memory until it is changed, including during power-off periods.

When you press the “Setup” softkey on the Control Display from the power-up state, the display changes to:

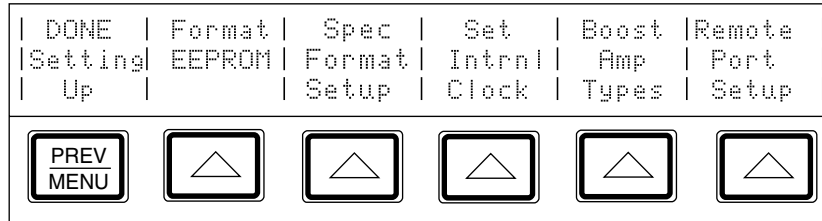


The list below describes sub-menus available through each softkey and tells you where you can find further information in the manuals.

- **Cal:** Opens the calibration menu. Softkeys in this menu activate calibration to external standards, calibration check, and dc zeros calibration. Another softkey displays calibration date information and another opens a calibration report menu. This chapter describes dc zeros calibration. Chapter 7 shows this menu and describes all other calibration procedures.
- **Self Test & Diags:** Opens the self testing and diagnostics menu. This menu contains a softkey to run self tests similar to the power-up self tests and softkeys that access separate menus to diagnose and troubleshoot the calibrator and an attached 5725A Amplifier. Chapter 5 of the *5700A/5720A Series II Service Manual* provides instructions for using these softkeys.
- **Instmt Setup:** Opens the instrument setup menu. This menu contains softkeys to open sub menus that let you change the calibration interval, set up the remote port, set the clock/calendar, and identify the amplifier model for current and voltage amplification. Another menu lets you format the EEPROM (Electrically Erasable Programmable Read Only Memory), which is nonvolatile memory. This is only necessary when you want to replace some or all of the information in memory with default values. The next part of this chapter describes the instrument setup menu and its sub-menus.
- **Instmt Config:** Opens a menu that contains two softkeys: one that displays a list of installed hardware modules and software revision letters, and another that displays the contents of the user report string. This chapter describes how to use these softkeys.
- **Special Functns:** Opens the special functions menu. This menu contains two softkeys: one that allows turning off ac internal transfers, and one to select the date format. This menu is described later in this chapter.

### 4-8. Instrument Setup

The softkeys in the instrument setup menu (accessed by pressing “Instmt Setup” softkey in the setup menu) are shown below.



The list below describes sub-menus accessed by each softkey and tells you where you can find further information in the manuals.

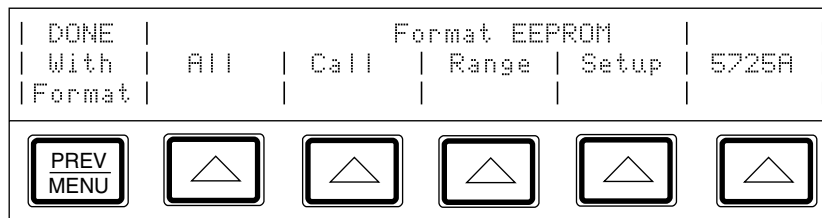
- **Format EEPROM:** Opens a menu that lets you restore all or part of the data in the EEPROM to factory defaults. The use of this menu is described next.
- **Spec Format Setup:** Opens a menu that lets you select the confidence level of the calibration specifications and calibration interval.
- **Set Intrnl Clock:** Accesses softkeys that allow you to check and set the date and time for the clock/calendar. This chapter describes how to set the time and date.
- **Boost Amp Types:** Selects the auxiliary amplifier model number for current and voltage boost. This chapter describes how to select the boost amp type.
- **Remote Port Setup:** Opens setup menus for the IEEE-488 instrument control port and the RS-232C serial interface port. Chapter 5 describes how to set up the IEEE-488 interface. Chapter 6 describes how to set up the serial interface.

### 4-9. Format EEPROM Menu

#### Caution

**Use with extreme care. The format EEPROM menu presents softkeys that permanently erase calibration constants. Pressing “ALL” or “CAL” invalidates the state of calibration of the 5700A/5720A Series II Calibrator.**

Pressing “Format EEPROM” in the instrument setup menu opens the following menu:



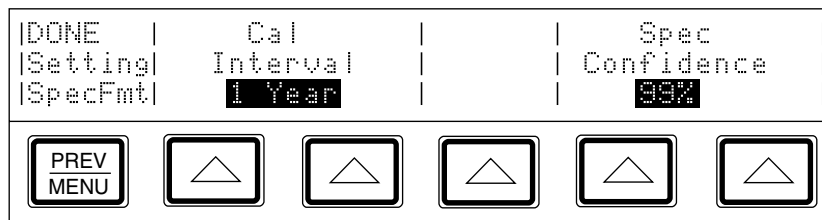
The EEPROM stores calibration constants and dates, setup parameters, and the user report string in non-volatile memory. Softkeys in this menu let you replace all or part of the contents with factory defaults. In the case of calibration constants, factory defaults are the same for all 5700A/5720A Series II calibrators. They are not the calibration constants obtained when the calibrator was originally calibrated by the factory before shipment. All the softkeys in this menu require the rear panel CALIBRATION switch to be in the ENABLE position.

The function of each softkey is described below:

- ALL: Replaces the entire contents of the EEPROM with factory defaults. This would be used by service personnel after replacing the EEPROM, for example. It is not required in normal use.
- CAL: Replaces all calibration constants with factory defaults but leaves all the setup parameters unchanged. This is also not required in normal use.
- RANGE: Removes only the range adjustments made during optional range calibration. See Chapter 7 for more information about range calibration.
- SETUP: Replaces the setup parameters with factory defaults, but leaves the state of calibration unchanged.
- 5725: Replaces all calibration constants stored in the attached 5725A with factory defaults, but leaves the calibrator's EEPROM contents unchanged.

#### 4-10. Spec Format Setup Menu

Pressing the softkey under “Spec Format Setup” opens the menu shown below, which provides options for configuring your specification confidence level, and for setting the calibration interval. Once you have completed making these selections, press “DONE Setting SpecFmt” to return to the Instrument Setup menu.



The function of each softkey is described below:

- Cal Interval: Sets the calibration cycle to 24 hours, 90 days, 180 days, or 1 year.
- Spec Confidence: Sets the calibration specification confidence level to 95% or 99%. All specifications are provided in Chapter 1 of this manual.

### 4-11. Setting the Internal Clock/Calendar

An internal clock/calendar provides the date (corrected for leap years) and time to the calibrator's CPU (Central Processing Unit). The clock setting should be checked and set if necessary.

*Note*


*A long-life lithium battery keeps the clock/calendar running during power-off periods. If the battery in your calibrator should ever need replacement, refer to the Service Manual. The battery is a button-type, soldered to the CPU Assembly (A20). Any procedure that involves removing the cover is for service personnel only.*

To set or change the time and date of the internal clock/calendar, proceed as follows:

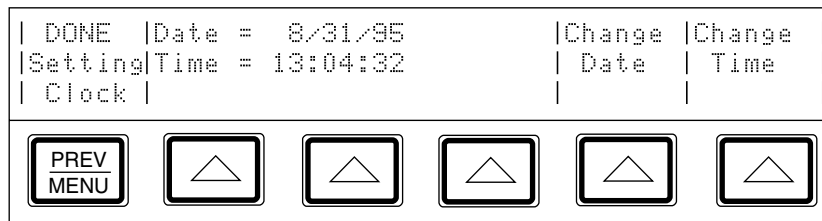
1. If you want to set the date or both date and time, set the rear panel CALIBRATION switch to ENABLE (see Figure 3-2). The setting of the CALIBRATION switch does not matter for setting time only.

2. Press the following sequence of softkeys:

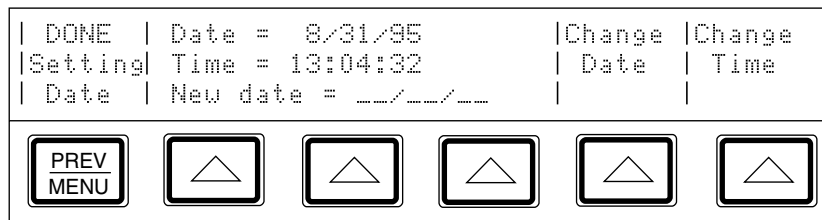
Setup Menus → Instmt Setup → Set Intrnl Clock

(If the Setup Menu is not displayed, press  first).

The display changes to:

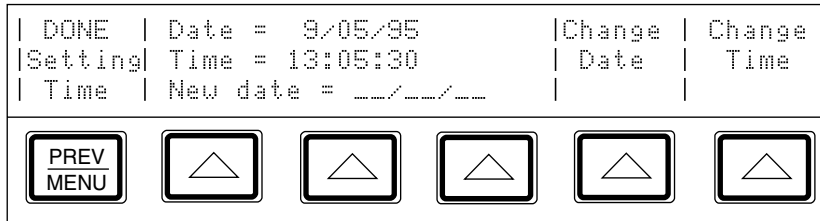


3. To change the date, press the “Change Date” softkey. (To leave the date setting as is and change the time instead, skip to step 5.) The display changes to:



4. Enter the date as six digits using the numeric keypad. The date format selected in the Special Functns menu determines the order in which you enter the digits (mmddy, ddmyy, or yymmdd). For example, in the format mmddy, September 5, 1996 is entered as 090596.

- Press the “Change Time” softkey. The display changes to:



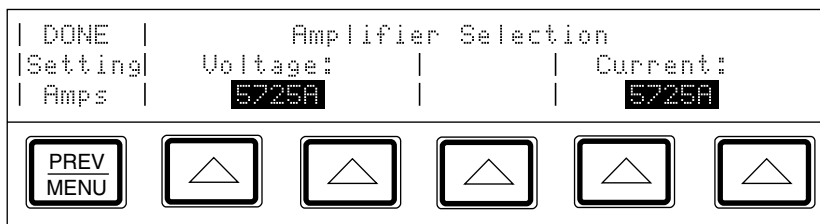
- Enter the 24-hour time as six digits in the format hhhmss using the numeric keypad (for example, 080500 for 8:05 am, or 130400 for 1:04 pm). Press  to start the clock at its new setting.
- Make sure the rear panel CALIBRATION switch to NORMAL.
- Press  three times to return to normal operation.

#### 4-12. Selecting Amplifiers

If you plan to use an auxiliary amplifier other than the 5725A, you may identify one amplifier for current boost and one amplifier for voltage boost. Model 5725A is the factory default for both voltage and current boost. To select other amplifiers, proceed as follows:

- Press the following sequence of softkeys:  
 Setup Menus → Instmt Setup → Boost Amp Types  
 (If the Setup Menu is not displayed, press  first).

The display changes to:



- Press a softkey under “Voltage:” to scroll the highlighted label until it displays 5725A.
- Press a softkey under “Current:” to scroll the highlighted label until it displays 5725A.
- To go to normal operation, press  three times.

### 4-13. Checking the Instrument Configuration

The softkey labeled “Instmt Config” in the setup menu gives you access to the following information:

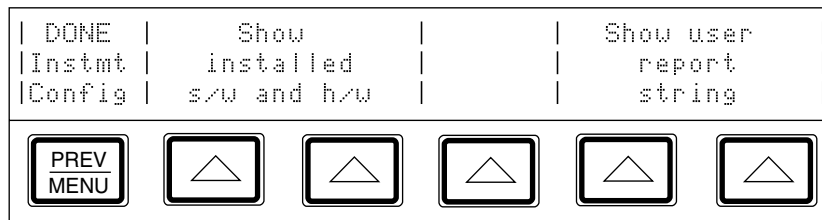
- Installed internal operating software revision letters.
- Whether the Wideband AC Module (Option 5700A-03) is installed.
- Which auxiliary amplifiers are attached, if any.
- The contents of the user report string (a general-purpose data storage location that is changeable only in remote control using the RPT\_STR command). You can use this register to store a property identification name or number, verification test record number, or other message. The message appears on calibration report printouts as described in Chapter 6. The rear panel CALIBRATION switch must be in the ENABLE position to change the user report string. Refer to Chapter 5 for how to use the RPT\_STR remote command.

To view this information, proceed as follows:

1. Press the “Setup Menus” softkey, then press the “Instmt Config” softkey. The display changes to:

(If the Setup Menu is not displayed, press **RESET** first.)

The following display appears:



2. Press either softkey under “Show installed s/w and h/w.” The display now shows the installed internal operating software revisions. To view the installed and attached hardware assemblies, press the “Go to h/w config” softkey.
3. After you have read the display, press the “MORE” softkey. If there are any more assemblies to display, they are displayed. After there are no more assemblies to display, the “h/w config” softkey returns control to the menu shown in step 1.
4. To return to normal operation, press **PREV MENU** twice.

To display the contents of the user report string, proceed as follows:


1. Press the “Setup Menus” softkey, then press the “Instmt Config” softkey.  
(If “Setup Menus” is not on the display, press **RESET** first.)
2. Press a softkey under the “Show user report string” label. This prints the user report string on the Control Display. To clear the display, press **PREV MENU**.
3. To go to normal operation, press **PREV MENU** twice.

#### 4-14. Special Functions Menu.



The softkey labeled “Special Functns” in the setup menu provides access to the AC Xfer Choice and the Date Format feature, which lets you select one of three date formats (m/d/y, d.m.y, and ymd). In remote, use DATEFMT to set the date format and DATEFMT? to query the date format. The AC Xfer Choice feature activates another softkey that lets you turn off the monitoring system that makes adjustments for load changes. The AC Xfer OFF feature is available only in the ranges below 220V, at frequencies below 120 kHz.

The AC Xfer OFF function remains active until the calibrator is reset or the power is turned off. For remote control applications, the same feature is accessible through the remote command XFER OFF. Send the command XFER ON to restore internal ac transfers to normal operation.

Turn off internal ac transfers as follows:


1. Press the “Setup Menu” softkey.
2. Press the “Special Functns” softkey.
3. Press the “AC Xfer Choice” softkey so that ON appears. This turns on an “Intrnl Xfers” softkey in the ac voltage function.
4. Press  twice.
5. After setting the output for an ac voltage, press the “Intrnl Xfers” softkey so that OFF appears. This will inhibit internal transfers from being made after the output has settled. It is particularly useful for making ppm level measurements at low frequencies. Changing the calibrator's output will reinitiate transfers until the output has settled.

#### 4-15. Resetting the Calibrator.


At any time during front panel operation, you can return the calibrator to the power-up state by pressing . Pressing  does the following:

- Returns the calibrator to the power-up state: 0 mV dc, standby, internal guard, and internal sense.
- Clears the stored values for limits, offset, scale, and error mode reference.

## 4-16. Operate and Standby Modes


When the OPERATE annunciator is lit, the output value and function shown on the Output Display are active at the selected terminals. When the STANDBY annunciator on the Output Display is lit, all calibrator binding posts except GROUND are open-circuited. To toggle between operate and standby modes, press .

If any of the following events occur during operation, the calibrator automatically switches to standby mode:

- The  key is pressed.
- A voltage  $\geq 22\text{V}$  is selected when the previous output voltage was less than 22V.
- The output location is changed, for example by selecting an amplifier. The exception is when the 5725A is selected for ac voltage or current, provided the calibrator's current output location is set to "5725A."
- The output function is changed from any of the following: a voltage much less than 22V, an ac voltage much greater than 22V, a dc voltage much greater than 22V, a dc current, an ac current, or a resistance. The exception is when the calibrator is in 5100B mode when switching between dc and ac current. In this case the calibrator will not switch to standby mode.

## 4-17. Connecting the Calibrator to a UUT

### Warning

**The calibrator is capable of supplying lethal voltages. Do not make connections to the output terminals when any voltage is present. Placing the instrument in standby may not be enough to avoid shock hazard, since the  key could be pressed accidentally. Press reset and verify that standby is lit before making connections to the output terminals.**

The binding posts labeled OUTPUT (HI, LO, and AUX I) deliver voltage, fixed resistance, and current to the UUT (Unit Under Test). The Type "N" connector on the front panel labeled WIDEBAND delivers the output signal from the Option 5700A-03 Wideband AC Module.

Depending on the output function, output amplitude, and input configuration of the UUT (Unit Under Test) or meter, connection to the SENSE binding posts, the GUARD binding post, and the GROUND binding post may also be required or recommended. The text in this chapter explains how and when to use these binding posts.

## 4-18. Recommended Cable and Connector Types

Cables can be connected to the binding posts using banana jacks, terminal lugs, or stripped insulated wire. To avoid errors induced by thermal voltages (thermal emfs), use connectors and conductors made of copper or materials that generate small thermal emfs when joined to copper. Avoid using nickel-plated connectors. Optimum results can be obtained by using Fluke Model 5440A-7002 or 5440A-7003 Low Thermal EMF Test Leads.

Cable requirements depend on the output function, amplitude, and frequency. Table 4-1 gives specific cable recommendations for all applications.


**Caution**  
**Use only cables with correct voltage ratings.**

**Table 4-1. Auxiliary Amplifier Data**

Output Function	Cable Recommendations
DC voltage AC voltage $\leq 10$ kHz AC current $\leq 2$ A, $\leq 10$ kHz DC current $\leq 2$ A Resistance	Low Thermal EMF Test Leads [Note 1] 5440A-7002 (banana plugs) or 5440A-7003 (spade lugs) 2 ft. (61 cm.) cable  (If external sensing is required, use a twisted shielded pair.)
AC voltage $> 10$ kHz	SENSE/GUARD: Triaxial cable or Twinax (e.g., Alpha 2829/2), OUTPUT: Coaxial  Or: SENSE: Coaxial, OUTPUT: Coaxial GUARD Lead: Separate wire
AC current with guard	Triaxial cable
Wideband AC	6-foot (2 m) 50 $\Omega$ coaxial cable with type "N" male connector supplied with the option. A 50 $\Omega$ feedthrough terminator is also supplied for connecting to meters with an impedance $> 50\Omega$ .
Voltage-boosted output, 5725A	Low Thermal EMF Test Leads [Note 1] 5440A-7002 (banana plugs) or 5440A-7003 (spade lugs)  (Output is at the calibrator's front panel.)
Current-boosted output, 5725A	16-gauge or heavier twisted pair insulated wire, as short as possible to minimize resistance and inductance. (Output is at the amplifier terminals.)
1. Spade lugs provide a slightly better thermal EMF performance. However, some UUTs have recessed banana connectors that cannot accommodate spade lugs.	


**4-19. When to Use External Sensing**

External sensing is normally required only when you are calibrating a device that draws enough current to produce a significant voltage drop in the cables. An example of such a case is using the calibrator as an external dc voltage reference for an AC/DC transfer standard. In this example, the calibrator is sourcing 1V dc into a Fluke 540B AC/DC Transfer Standard. The 180 $\Omega$  input impedance results in a current flow of approximately 5 mA. The calibrator's 90-day uncertainty at 1V is specified to be  $\pm(6 \text{ ppm} + 1.2 \text{ uV})$  or  $\pm 7.2 \text{ }\mu\text{V}$ . Cumulative lead and contact resistances of as little as 2 m $\Omega$  would cause a voltage drop greater than the total uncertainty of the calibrator. External sensing eliminates this error.

The normal power-up state of the calibrator is external sensing off, with an internal connection between the SENSE and OUTPUT automatically made. This is the state achieved by pressing  so that the indicator is off.

#### 4-20. When to Use the External Voltage Guard

The voltage guard protects the analog circuitry by placing an electrical shield between the primary and secondary of the ac line power transformer. An optical cable transmits control information from the calibrator's microprocessor to analog circuits. The voltage guard provides a low-impedance path for common-mode noise and ground loop currents.

The voltage guard is usually internally connected to the OUTPUT LO terminal. This is the normal power-up state of the calibrator, and the connection is automatically made when the external guard is not selected ( pressed so that the indicator is off).

If you are calibrating a UUT with a grounded low or common input terminal, you need an external connection to the V GUARD. The calibrator's voltage guard must be grounded at the UUT. (To avoid ground loops you must have only one ground connection in the system, so all ground connections should be made at the UUT. To maintain one ground point, make sure there is no grounding strap connected to the calibrator.)

#### 4-21. When to Use the Current Guard

The rear panel CURRENT GUARD is required when the calibrator is supplying low-level ac current through a long cable, such as in a system. For that reason, a current guard terminal is supplied on the rear panel where it is convenient for system applications.

The current guard is active only when the calibrator is in the ac current function. The guard is voltage driven and is in phase with the calibrator's output current to the level of compliance voltage at the OUTPUT HI terminal. Compliance voltage is the sum of the UUT burden voltage and the additional burdens of contact resistances and cable losses. When connected to the inner shield of a triaxial cable, the current guard blocks a potentially significant leakage path by surrounding the output current with an in-phase voltage at the same potential. Current leakage still occurs, but only between the guard voltage on the inner cable shield and the grounded outer cable shield.

An example where current guarding is desirable is when you are sourcing 100  $\mu\text{A}$  at 1 kHz through a 3-meter coaxial cable into a UUT with a burden voltage of 1V. At 100 pF per meter of length, the cable places an additional 300 pF load across the calibrator's output. The amount of current leakage through the cable capacitance is:

$$I = V(2\pi fC)$$

Where,

$$V = 1\text{V}$$

$$f = 1 \text{ kHz} = 1 \times 10^3 \text{ Hz}$$

$$C = 300 \text{ pF} = 300 \times 10^{-12} \text{ F}$$

So the total leakage is:

$$I = (1)(2)(\pi)(10^3)(300)(10^{-12}) = 1.9 \mu\text{A}$$

This will add in quadrature to the current through a resistive load causing an error of:

$$\sqrt{100^2 + 1.9^2} - 100 = 0.018 \mu\text{A}$$

At 100  $\mu\text{A}$ , the calibrator's 90-day uncertainty is specified to be  $\pm 140 \text{ ppm} + 20 \text{ nA}$ , or  $\pm 0.034 \mu\text{A}$ . The current leakage here is over half the calibrator's uncertainty. The error caused by this leakage can be minimized by using the current guard.

## 4-22. Four-Wire Vs. Two-Wire Resistance Connections

Figure 4-4 shows four different ways to connect to a UUT for resistance calibration. Figure 4-4A shows a UUT with four-wire sensing. For such meters, you should always take advantage of the four-wire sensing capability and use external sensing to achieve the highest accuracy. (Four-wire sensing is available for all resistance values except 100 M $\Omega$ .)

For calibrating a meter with only a two-wire resistance mode such as a typical handheld DMM, refer to Figures 4-4B through 4-4D. For resistances of 19 k $\Omega$  or lower in two-wire mode, compensation circuitry inside the calibrator is available to remove errors introduced by resistance in the path between the front panel terminals and the precision resistor. Depending on how you connect the meter, you can use two-wire compensation referenced at the UUT terminals (Figure 4-4C) or at the ends of the UUT's test leads (Figure 4-4D). See "Resistance Output" for information on turning on and off two-wire compensation circuitry.

Figure 4-4B shows a meter connected in a two-wire connection with the two-wire compensation circuitry turned off. For low resistances where uncompensated lead resistances are significant, use the two-wire compensation circuit and the connection in Figure 4-4C or 4-4D. Use the connection in Figure 4-4C if you want to calibrate the meter referenced at its terminals. Use the connection in Figure 4-4D if you want to calibrate the meter referenced at the end of its test leads.

## 4-23. Cable Connection Instructions

To connect the calibrator to a UUT, proceed as follows:

1. If the calibrator is turned on, press , or   . Either action sets the calibrator to 0 mV in standby.
2. Determine the appropriate figure from Table 4-2, and refer to the preceding text and Table 4-1 to make appropriate connections to the UUT.

Table 4-2. UUT Connection Figures

5700A/5720A Series II Output	Figure
DC Voltage (including 5725A boost)	4-1
AC voltage $\leq 10$ kHz	4-1
AC voltage $> 10$ kHz	4-2
AC current $\leq 2$ A, $\leq 10$ kHz	4-3
Resistance	4-4
Wideband AC voltage (option 5700A-03)	4-5
5725A amplified output (current only)	4-6

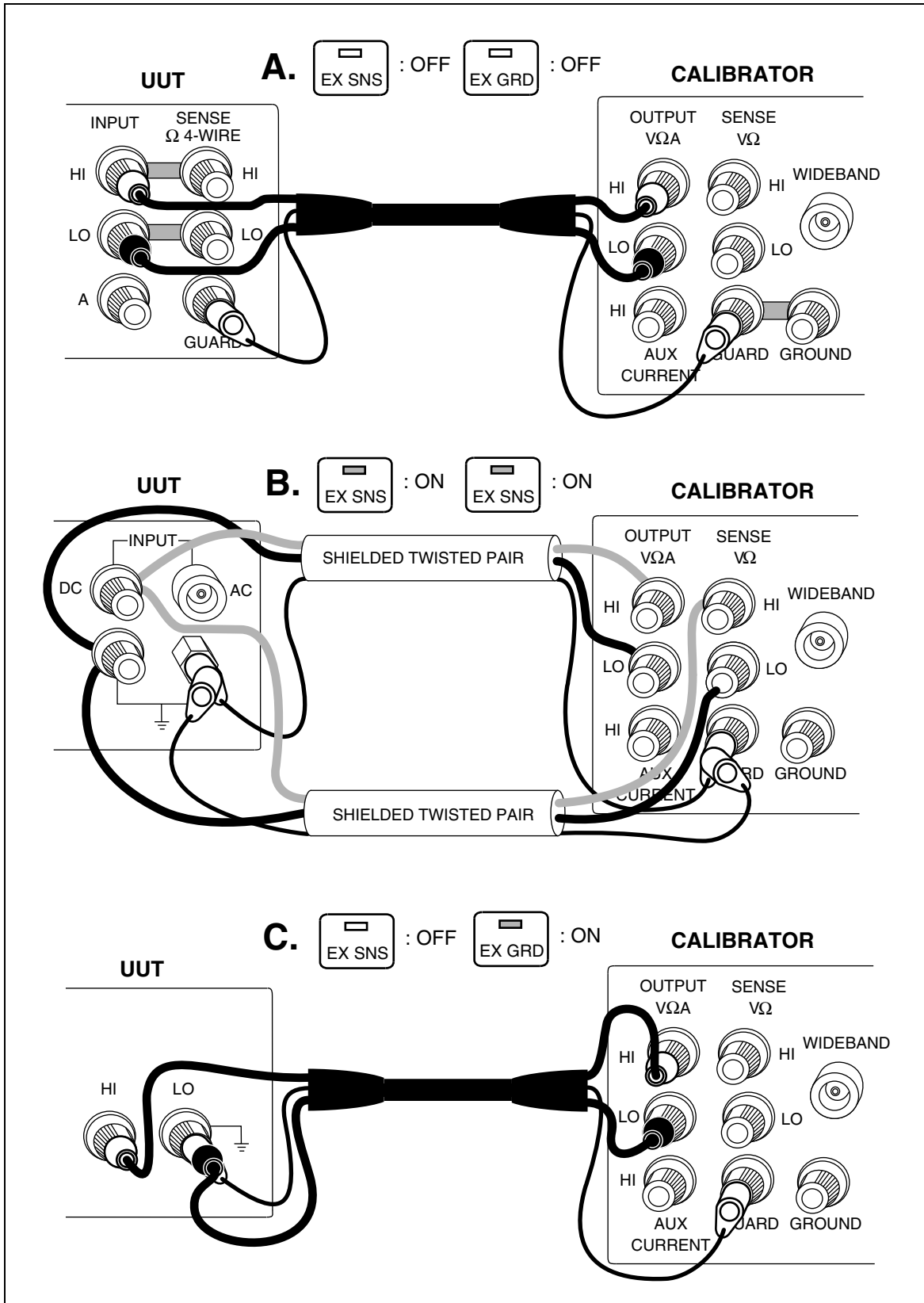


Figure 4-1. UUT Connections: DC Voltage, AC Voltage  $\leq 10$  kHz

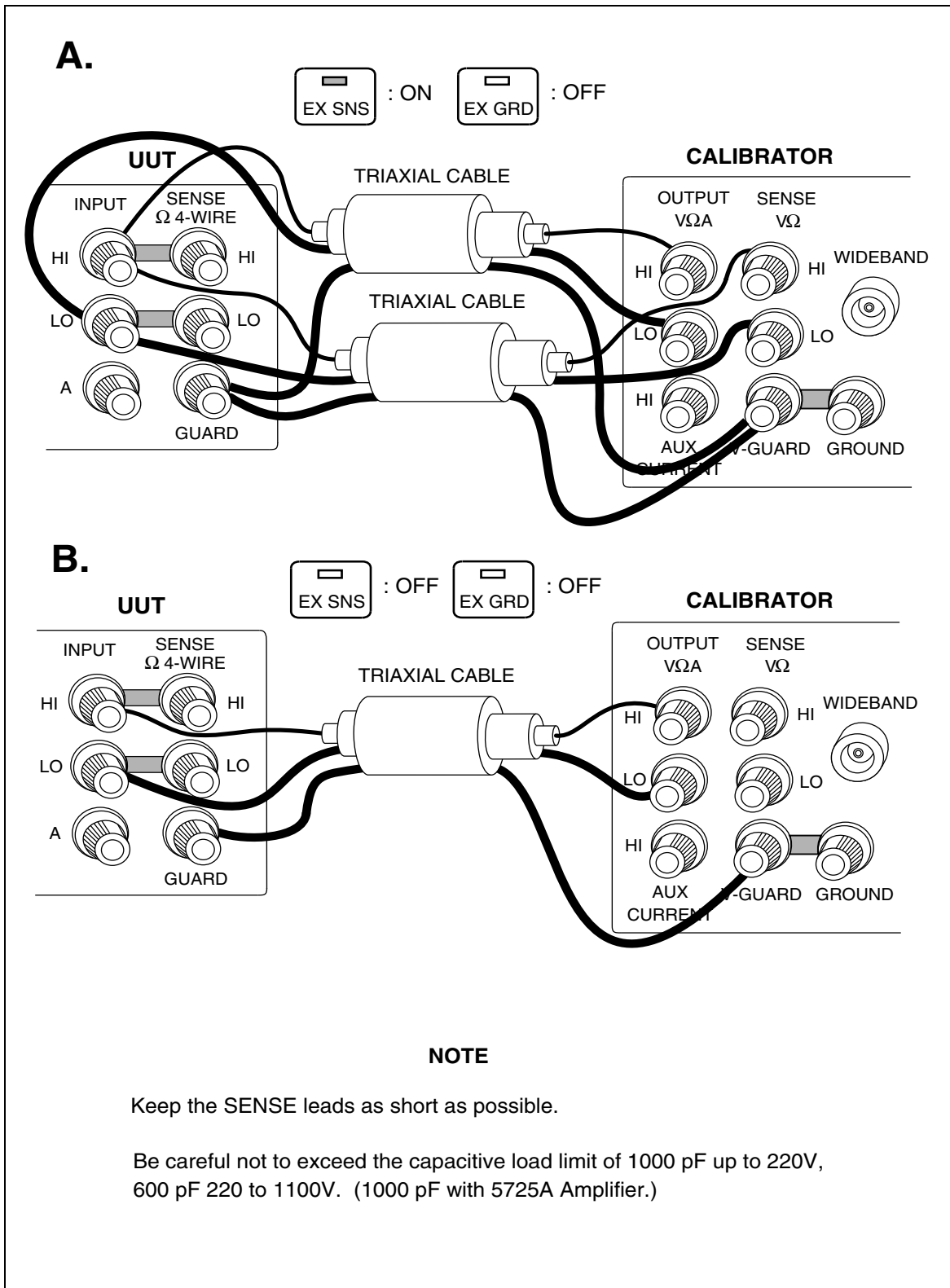


Figure 4-2. UUT Connections: AC Voltage >10 kHz

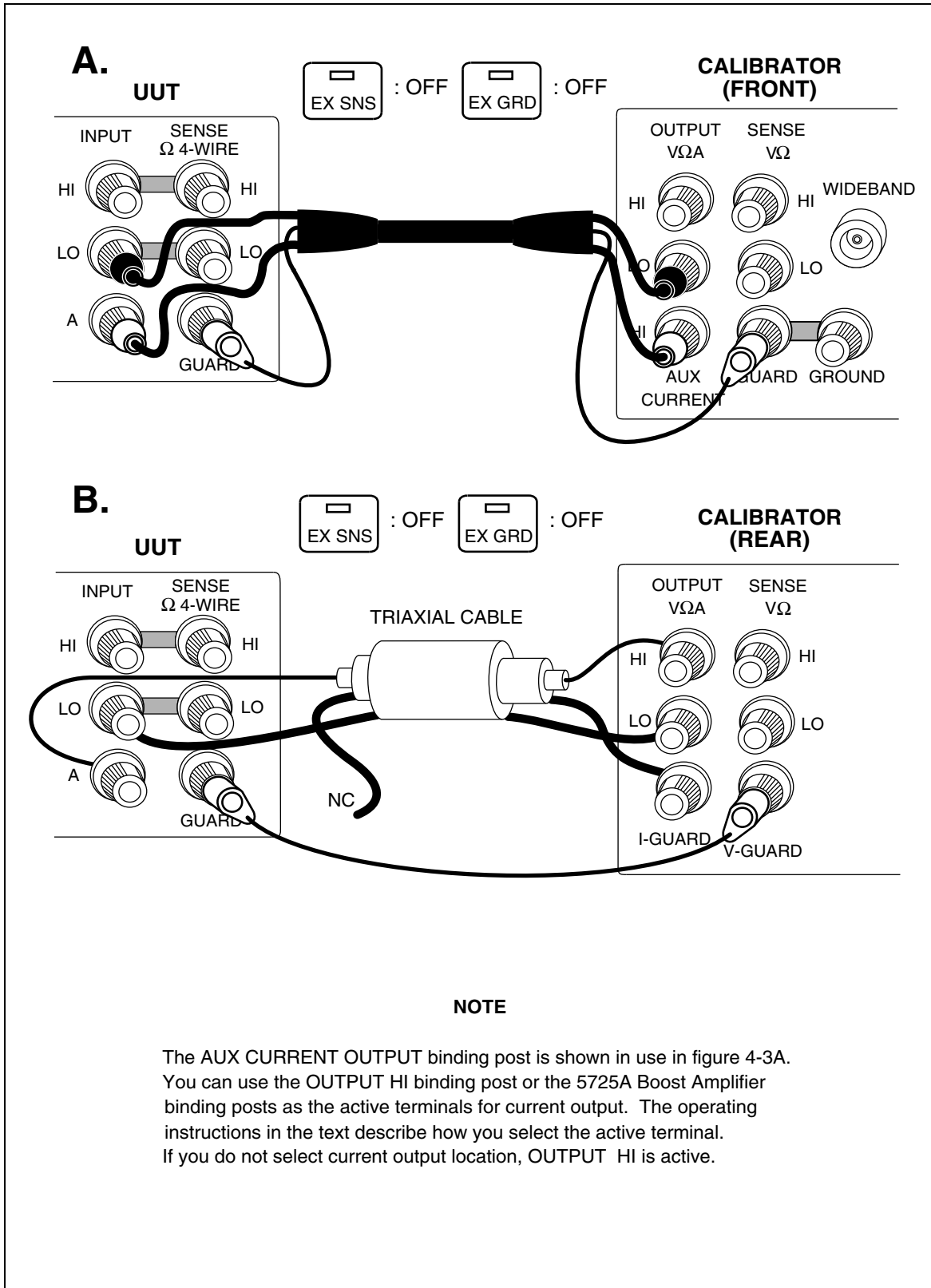
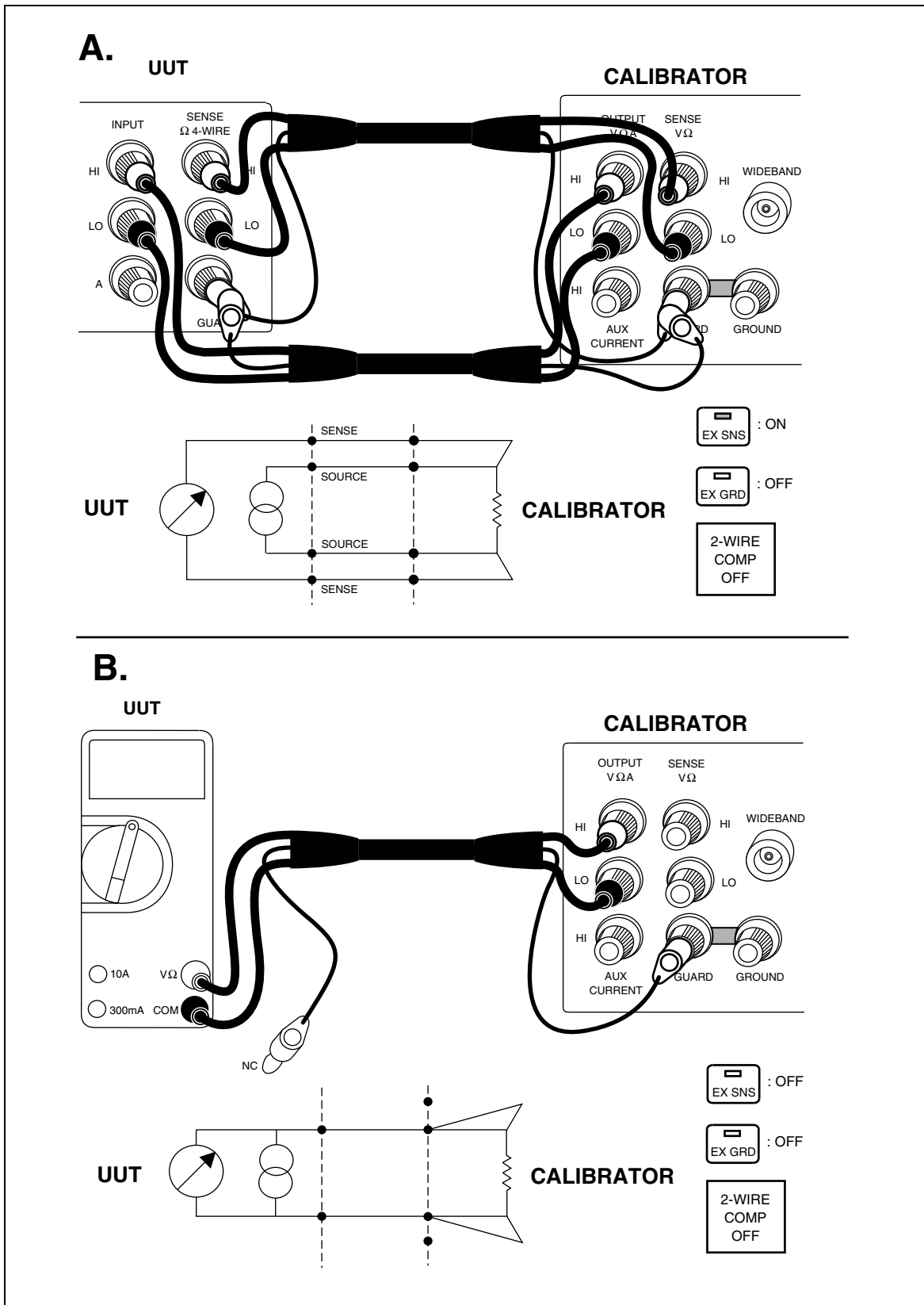


Figure 4-3. UUT Connections: AC Current  $\leq 2A$



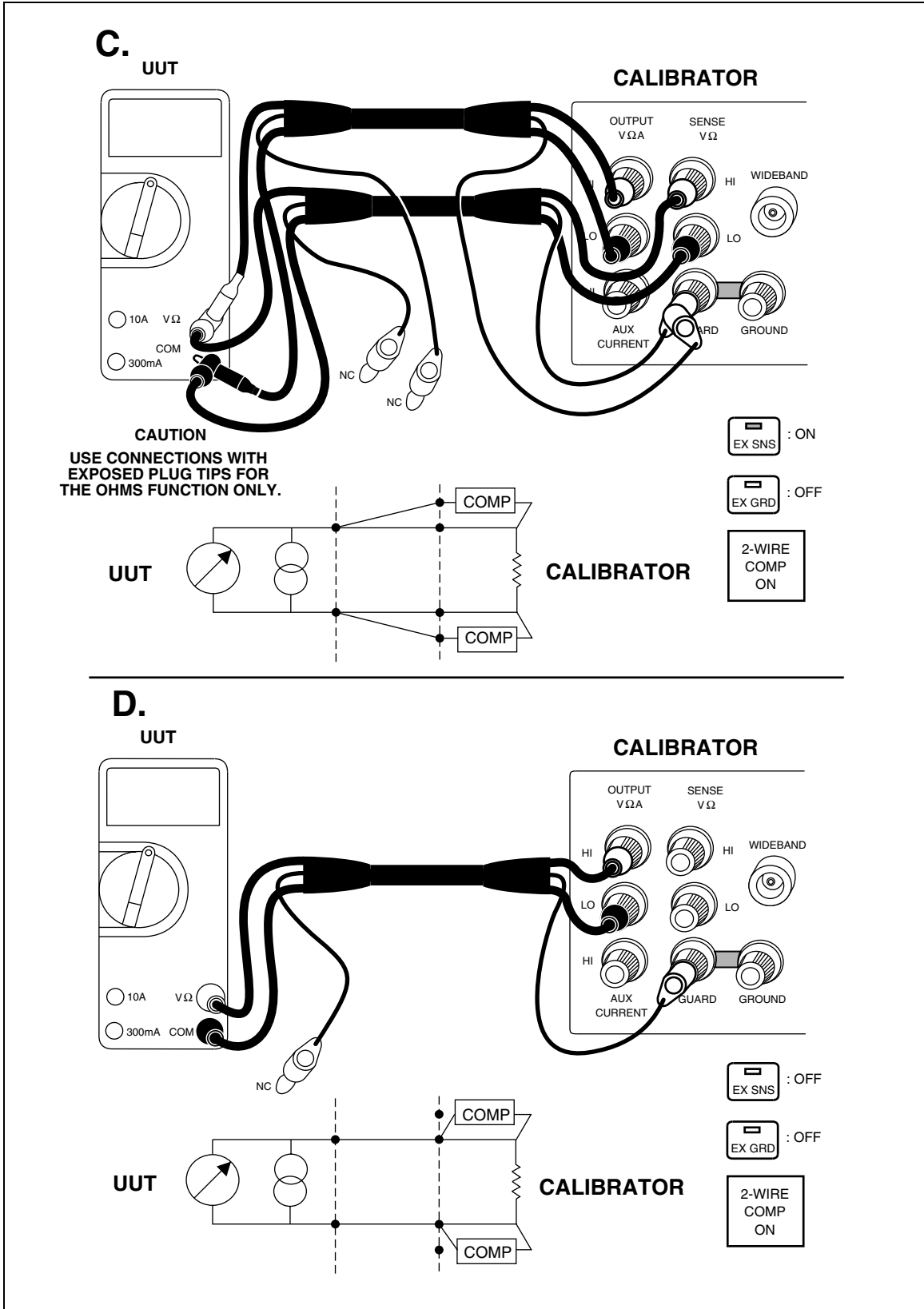


Figure 4-4. UUT Connections: Resistance (Continued)

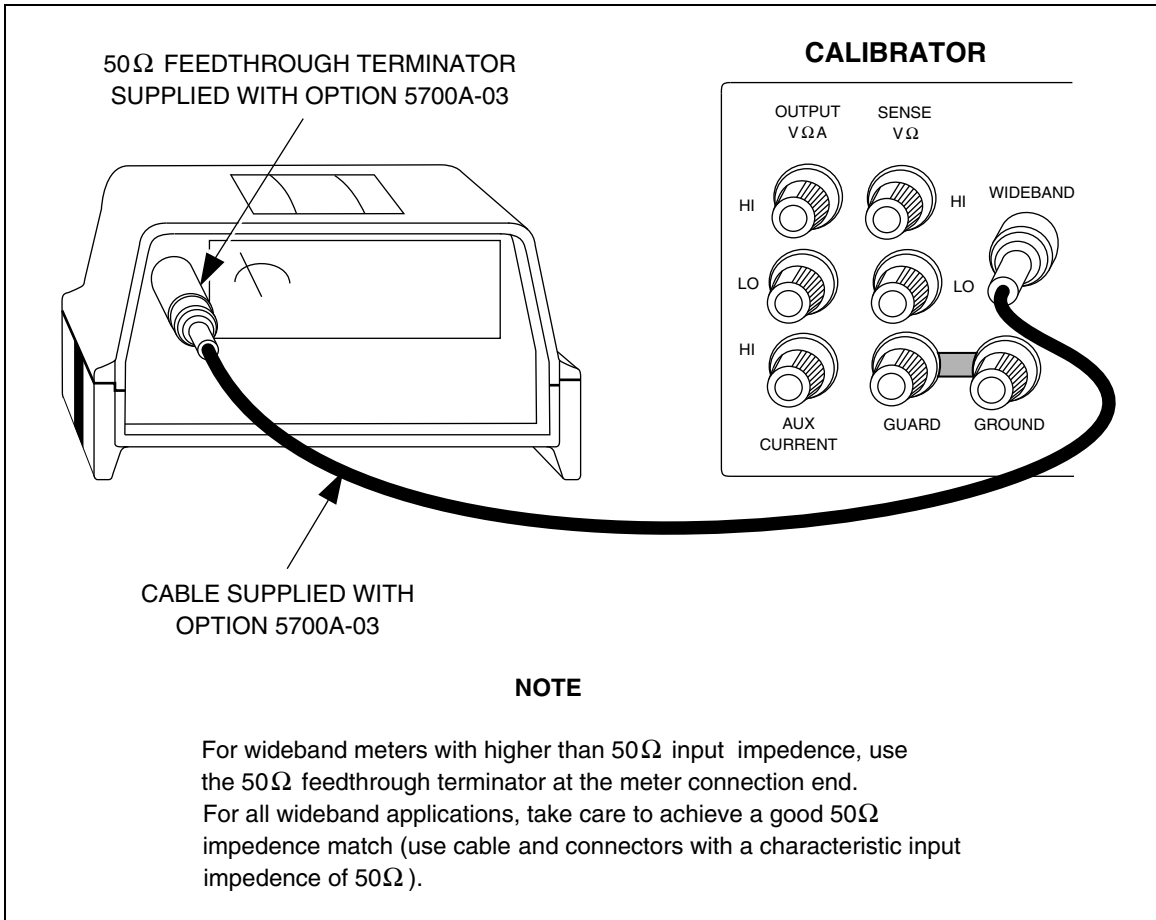


Figure 4-5. UUT Wideband AC Voltage Output (Option 5700A-03)

### 4-24. Setting the Output

To set the output, simply press the following sequence of keys to select an output function and amplitude:

[numeric keys] → [multiplier] → [function] →  →

For example, to set the output to 10 mV dc, press:

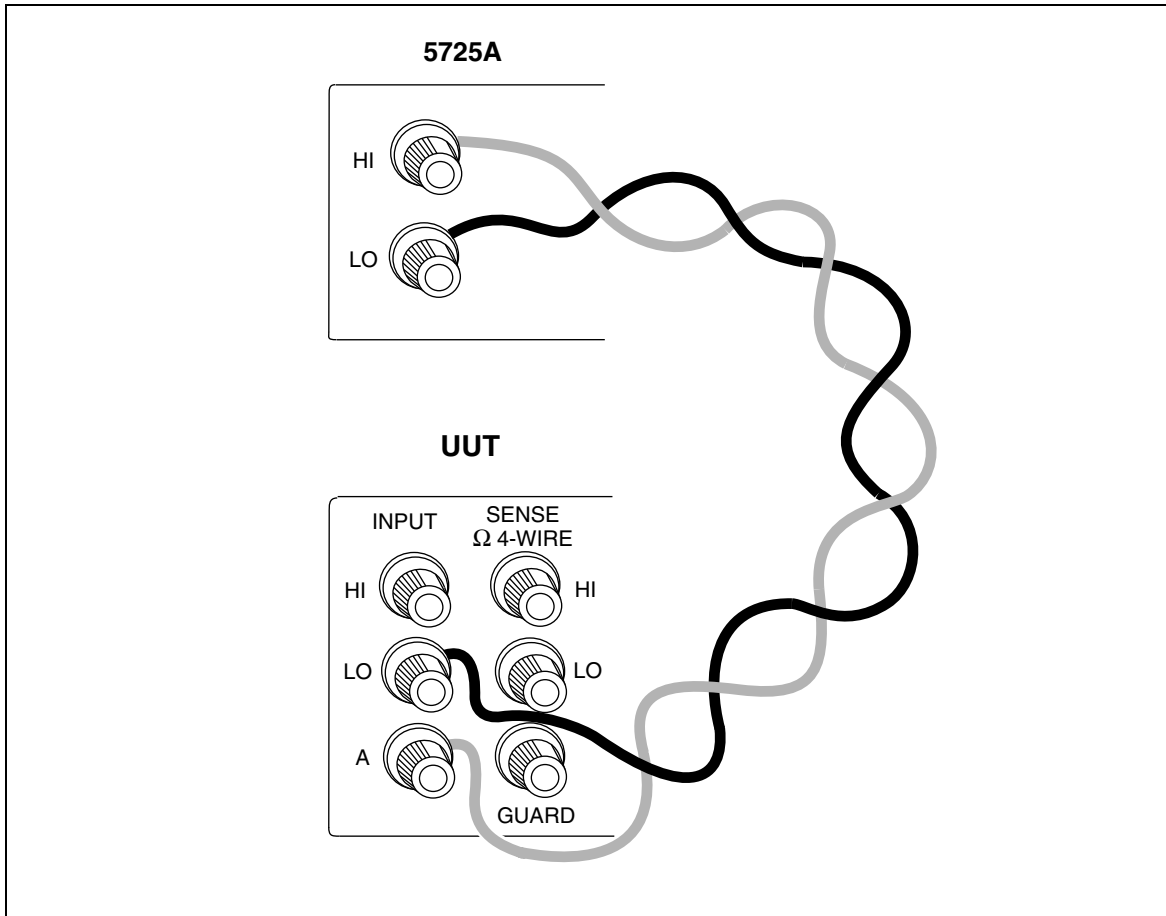
To set an ac output, press the following additional keys:

[numeric keys] → [multiplier] →  →

For example, to change the present 10 mV dc to 10 mV ac at 1.8 kHz, press:

To change the output back to dc, simply press:

, or










**Figure 4-6. UUT Connections: 5725A Amplified Current Output**

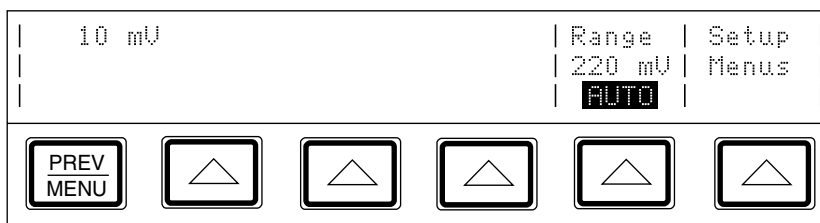
The following step-by-step procedures explain how to set a desired output and how to use the features available for each output function:




- DC voltage
- AC voltage
- DC current
- AC current
- Resistance
- Wideband ac voltage (Option 5700A-03)
- Variable phase
- Boost operation (using an auxiliary amplifier)

## 4-25. DC Voltage Output

To set a dc voltage output, proceed as follows:

1. Make sure the calibrator is in standby (STANDBY annunciator lit). Press  if necessary.
2. If the UUT is not connected, connect it now as described earlier in this chapter under “Connecting the Calibrator to a UUT.”
3. Set the UUT to measure dc voltage on the appropriate range.
4. Press up to eight numeric keys to select a voltage.
5. To change the polarity of your entry, press .
6. Press , , or  if necessary.
7. Press .
8. The Control Display now shows the amplitude of your entry. If you made an entry error, press  to clear the display, then reenter the value. The following illustration of the Control Display assumes an entry of 10 mV:




9. Press . The calibrator clears your entry from the Control Display and copies it into the Output Display. No voltage is available at the output terminals, however, until you press .
10. Press  to activate the calibrator’s output. The UUT will now respond to the applied voltage.

Two softkey labels appear on the Control Display in the dc voltage function: “Range” and “Setup Menus.”

- The “Range” softkey selects autorange or lock for the present range. When the range is set to AUTO (the default setting), the calibrator automatically selects the lowest possible range. The minimum output on all ranges except the 1100V range is 0V. The minimum output on the 1100V range is 100V.
- The “Setup Menus” softkey opens the setup menu.

### 4-26. AC Voltage Output

To set an ac voltage output, proceed as follows:








1. Make sure the calibrator is in standby (STANDBY annunciator lit). Press  if necessary.
2. If the UUT is not connected, connect it now as described earlier in this chapter under “Connecting the Calibrator to a UUT.”
3. Set the UUT to measure ac voltage on the appropriate range.
4. Press up to seven numeric keys to select a voltage output in volts or dBm.

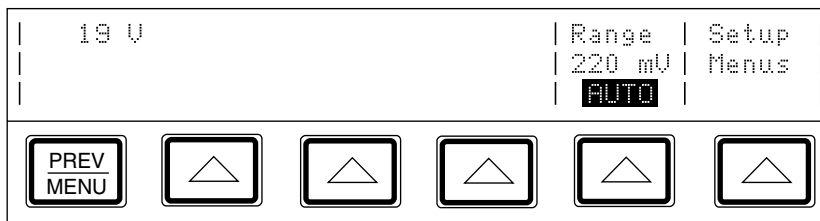
In the ac voltage function, dBm means decibels relative to 1 mW, calculated for a 600Ω load. The formula to calculate dBm is  $10 \log(\text{power in mW})$ . For example, if 3.0V is supplied to a 600Ω load, the dBm level is:

$$10 \log (15.0 \text{ mW}) = 11.7609 \text{ dBm.}$$

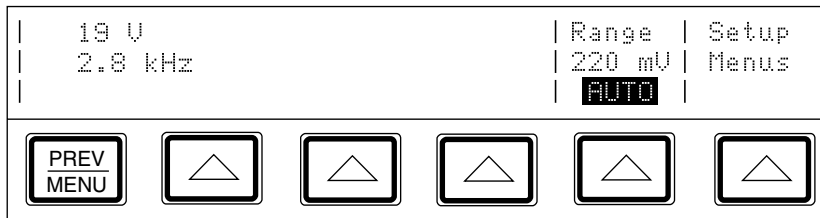
If you switch to Wideband AC output, but keep dBm as the displayed units, the dBm value will change. The value changes because dBm is calculated for a 50Ω load in the Wideband AC output function. Using the same voltage level as in the previous example, if you switch to Wideband AC output, the dBm level changes to:

$$10 \log (180.0 \text{ mW}) = 22.5527 \text{ dBm.}$$

5. To enter a negative dBm value, press .
6. Press , , or  if necessary.
7. Press  for volts, or press  for a dBm level.
8. The Control Display now shows the amplitude of your entry. If you made an entry error, press  to clear the display, then reenter the value. The following illustration of the Control Display assumes an entry of 19V:

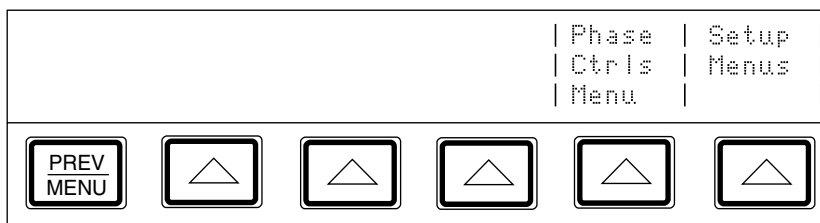


9. Press up to five numeric keys to select a frequency, followed by **[k]** or **[m]** if necessary. The Control Display now shows the amplitude and frequency of your entry. If you made an entry error, press **[CE]** to clear the display, then reenter the value. The following illustration of the Control Display assumes an entry of 2.8 kHz:



10. Press **[ENTER]**. The calibrator clears your entry from the Control Display and copies it into the Output Display. No voltage is available at the output terminals, however, until you press **[OPR STBY]**.
11. Press **[OPR STBY]** to activate the calibrator's output. The UUT will now respond to the applied voltage.

Two softkey labels appear on the Control Display in the ac voltage function: "Phase Ctrls Menu" and "Setup Menus":









- The "Phase Ctrls Menu" softkey activates the front panel controls for phase output. (Instructions for setting a phase output are under "Phase Output," later in this chapter.)
- The "Setup Menus" softkey opens the setup menu.

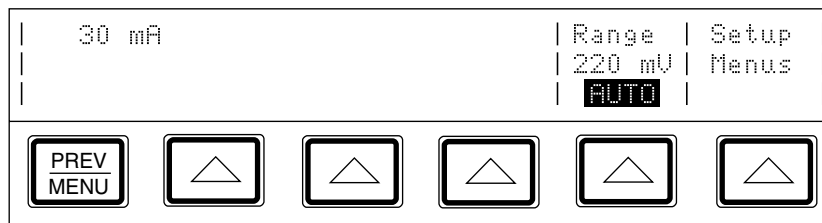
*Note*




*The calibrator stays in the ac function after you enter a non-zero frequency. If you want to change back to dc, simply enter a frequency of 0 Hz or a signed voltage.*

### 4-27. DC Current Output

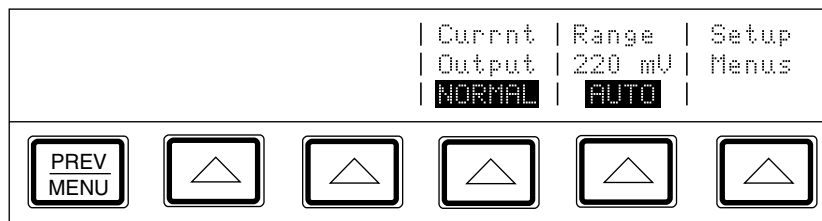
To set a dc current output, proceed as follows:

1. Make sure the calibrator is in standby (STANDBY annunciator lit). Press  if necessary.
2. If the UUT is not connected, connect it now as described earlier in this chapter under “Connecting the Calibrator to a UUT.”
3. Set the UUT to measure dc current on the appropriate range.
4. Press up to seven numeric keys to select an amperage level.
5. To change the polarity of your entry, press .
6. Press  or  if necessary.
7. Press .
8. The Control Display now shows the amplitude of your entry. If you made an entry error, press  to clear the display, then reenter the value. The following illustration of the Control Display assumes an entry of 30 mA:



9. Press . The calibrator clears your entry from the Control Display and copies it into the Output Display. No current is available at the output terminals, however, until you press .
10. Press  to activate the calibrator’s output. The UUT will now respond to the applied current.

Three softkey labels appear on the Control Display in the dc current function: “Currnt Output”, “Range”, and “Setup Menus”:



- The “Currnt Output” softkey selects one of three locations for current output: the OUTPUT binding post (NORMAL, which is the OUTPUT HI binding post, also the default setting); AUX, which is the AUX CURRENT OUTPUT binding post, or 5725A, which is the 5725A Amplifier binding posts. (The 5725A must be turned on, but not necessarily activated.)






*Note*

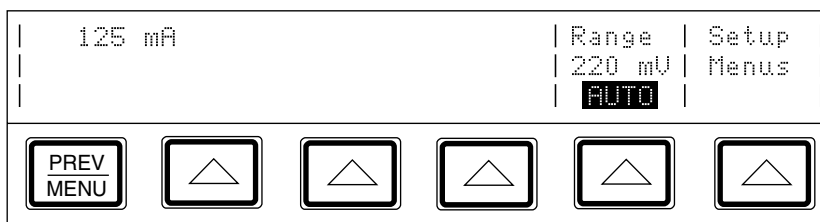
*If AUX is selected for a calibrator configured for rear output, error message: “Compliance voltage exceeded” will be displayed. For rear output, use the NORMAL setting.*

- The “Range” softkey selects autorange or lock for the present range. When the range is set to AUTO (the default setting), the calibrator automatically selects the lowest possible range.
- The “Setup Menus” softkey opens the setup menu.

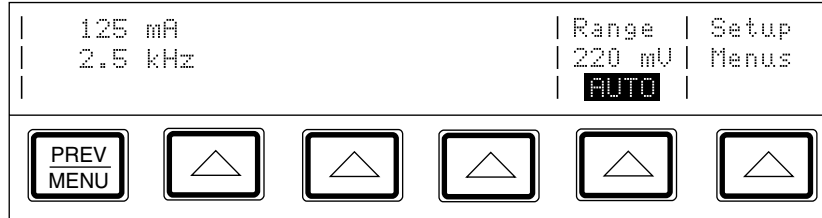
#### 4-28. AC Current Output

To set an ac current output, proceed as follows:

1. Make sure the calibrator is in standby (STANDBY annunciator lit). Press  if necessary.
2. If the UUT is not connected, connect it now as described earlier in this chapter under “Connecting the Calibrator to a UUT.”
3. Set the UUT to measure ac current on the appropriate range.
4. Press up to seven numeric keys to select an amperage level.
5. Press  or  if necessary.
6. Press .
7. The Control Display now shows the amplitude of your entry. If you made an entry error, press  to clear the display, then reenter the value. The following illustration of the Control Display assumes an entry of 125 mA:

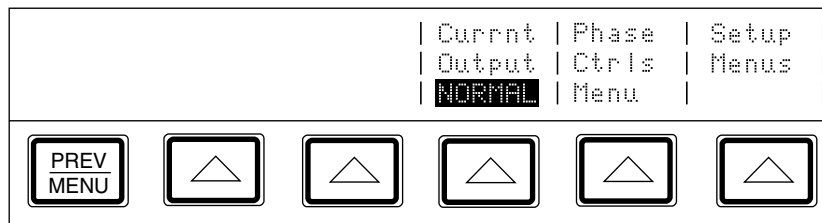


- Press up to five numeric keys to select a frequency (followed by **[k]** if necessary). The Control Display now shows the amplitude and frequency of your entry. If you made an entry error, press **[CE]** to clear the display, then reenter the value. The following illustration of the Control Display assumes an entry of 2.5 kHz:



- Press **[ENTER]**. The calibrator clears your entry from the Control Display and copies it into the Output Display. No current is available at the output terminals, however, until you press **[OPR STBY]**.
- Press **[OPR STBY]** to activate the calibrator's output. The UUT will now respond to the applied current.

Three softkey labels appear on the Control Display in the ac current function: "Currnt Output", "Phase Ctrls Menu", and "Setup Menus" as shown below:



- The "Currnt Output" softkey selects one of three locations for current output: the OUTPUT binding post (NORMAL, which is the OUTPUT HI binding post, also the default setting); AUX, which is the AUX CURRENT OUTPUT binding post, or 5725A, which is the 5725A Amplifier binding posts. (The 5725A must be turned on, but not necessarily activated.)

*Note*

*If AUX is selected for a calibrator configured for rear output, error message: "Compliance voltage exceeded" will be displayed. For rear output, use the NORMAL setting.*





- The “Phase Ctrls Menu” softkey activates the front panel controls for phase output. (Instructions for setting a phase output are under “Phase Output,” further on in this chapter.)
- The “Setup Menus” softkey opens the setup menu.

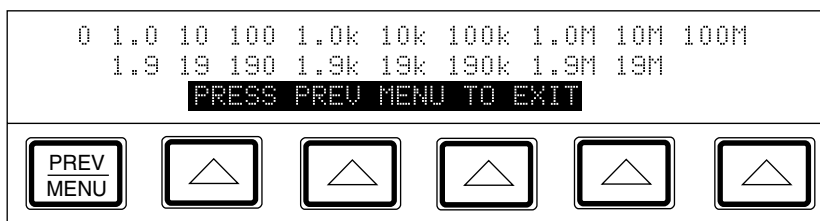
*Note*

*The calibrator stays in the ac function after you enter a non-zero frequency. If you want to change back to dc, simply enter a frequency of 0 Hz or a signed current magnitude.*





#### 4-29. Resistance Output


In the resistance function, the calibrator supplies your choice of 17 standard resistance values or a short at the output terminals. You can display a table of the available resistance values on the Control Display. To display the table, proceed as follows:

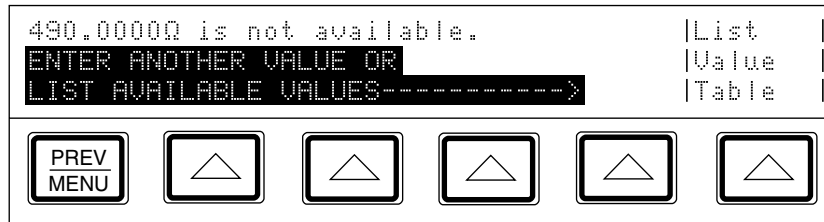
1. Make sure the calibrator is in standby (STANDBY annunciator lit). Press  if necessary.
2. Press , , then .
3. Press the “List Table Values” softkey. The calibrator shows a table of available resistance values on the Control Display:





To select a resistance output, proceed as follows:

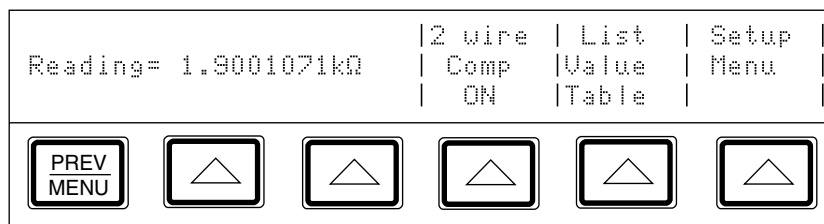
1. Make sure the calibrator is in standby (STANDBY annunciator lit). Press  if necessary.
2. If the UUT is not connected, connect it now as described previously in this chapter under “Connecting the Calibrator to a UUT.”
3. Set the UUT to read resistance on the appropriate range.
4. Press the numeric keys of the nominal resistance.
5. Press  or  if necessary.
6. Press .

- Press . If you entered a resistance value that is unavailable (as in the following example of 490Ω), the Control Display prompts you to try again. If you want to review the available resistance values, press the “List Value Table” softkey.




- After you specify a valid resistance and press , the calibrator clears your entry from the Control Display and shows the characterized (true) resistance value on the Output Display and on the Control Display.
- Press . This resistance is now available at the output terminals.

Depending on the value set, two or three softkey labels appear on the control display in the resistance function: “2 wire Comp”, “List Value Table”, and “Setup Menus”:




- The “2 wire Comp” softkey only appears for resistance values of 19 kΩ or lower. It turns on and off internal two-wire lead compensation circuitry. (See the full explanation on its use below.)
- The “List Value Table” softkey lists the nominal resistance values that the calibrator can produce.
- The “Setup Menus” softkey opens the setup menu.

In the resistance function, two features are available to enhance accuracy: four-wire sensing and two-wire compensation. Two-wire compensation works with either a two-wire connection or a four-wire connection to a two-wire ohmmeter. A full explanation follows:

Four-wire connection is available for all resistance values except 100 M $\Omega$ . To activate four-wire resistance, press  so that the indicator lights. (Figure 4-4A shows the four-wire connection.)


For calibrating a meter with a two-wire resistance mode such as a typical handheld DMM, refer to Figures 4-4B through 4-4D. For resistances of 19 k $\Omega$  or lower in two-wire mode, compensation circuitry inside the calibrator is available to remove errors introduced by resistance in the path between the front panel terminals and the precision resistor. The softkey label “2 wire Comp” appears on the Control Display when you select resistances of 19 k $\Omega$  or lower. This softkey allows you to disable and enable the compensation circuitry.



Depending on how you connect the meter, you can use two-wire compensation referenced at the UUT terminals (Figure 4-4C) or at the calibrator’s terminals (Figure 4-4D). See “Resistance Output” for information on turning on and off two-wire compensation circuitry.

Figure 4-4B shows a meter connected in a two-wire connection with the two-wire compensation circuitry turned off. Use this configuration only if lead resistances are insignificant. For a two-wire connection, press  so that the indicator is off.

For resistances where uncompensated lead resistances are significant, use the two-wire compensation circuit and the connection in Figure 4-4C or 4-4D. Use the connection in Figure 4-4C if you want to calibrate the meter referenced at its terminals. Use the connection in Figure 4-4D if you want to calibrate the meter referenced at the ends of its test leads.

### **4-30. Wideband AC Voltage Output (Option 5700A-03)**

To set an output from the Wideband AC Module (Option 5700A-03), proceed from  or the power-up state as follows:

1. Make sure the calibrator is in standby (STANDBY annunciator lit). Press  if necessary.
2. If the UUT is not connected, connect it now as described previously in this chapter under “Connecting the Calibrator to a UUT.”
3. Set the UUT to read ac voltage on the appropriate range.
4. Press .
5. Press the numeric keys for the desired output, expressed as voltage or a dBm level.

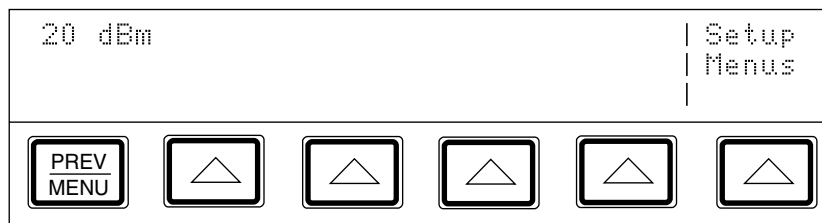
In the Wideband AC function, dBm means decibels above or below 1 mW, calculated for a 50Ω load. The formula to calculate dBm is  $10 \log(\text{power in mW})$ . For example, if 3.0V is supplied to a 50Ω load, the dBm level is:

$$10 \log (180.0 \text{ mW}) = 22.5527 \text{ dBm}$$

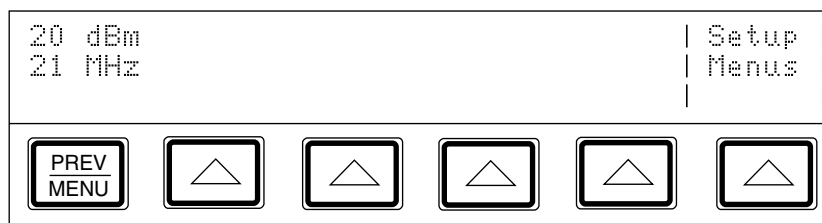
If you switch to standard ac output, but keep dBm as the displayed units, the dBm value will change. The value changes because dBm is calculated for a 600Ω load in the standard ac output function. Using the same voltage level as in the previous example, if you switch to standard ac output, the dBm level changes to:




$$10 \log (15.0 \text{ mW}) = 11.7609 \text{ dBm.}$$

6. If you want to enter a negative dBm value, press  $\boxed{+/-}$ .
7. Press  $\boxed{\mu}$  or  $\boxed{m}$  if necessary.
8. Press  $\boxed{v}$  for volts or  $\boxed{\text{dBm}}$  for volts expressed as dBm.
9. The Control Display now shows the amplitude of your entry. If you made an entry error, press  $\boxed{\text{CE}}$  to clear the display, then reenter the value. The following illustration of the Control Display assumes an entry of 20 dBm:




10. Press up to five numeric keys to select a frequency, followed by  $\boxed{k}$  or  $\boxed{M}$  if necessary. The Control Display now shows the amplitude and frequency of your entry. If you made an entry error, press  $\boxed{\text{CE}}$  to clear the display, then reenter the value. The following illustration of the Control Display assumes an entry of 21 MHz:



11. Press . The calibrator clears your entry from the Control Display and copies it into the Output Display. No voltage is available at the WIDEBAND Type “N” coaxial connector however, until you press .
12. Press  to activate the calibrator’s output. The UUT will now respond to the applied voltage.

*Note*

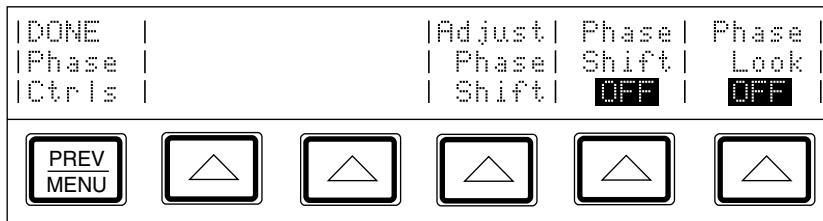
*To deactivate the Wideband AC Module and switch to another output function, press . If you are sourcing an ac voltage or dBm level within the range of the standard ac voltage output mode, that value is selected. Otherwise, the Output Display reads 0 mV (dc). When you are using units of dBm and switching between wideband and standard ac voltage output, the amplitude changes. This change occurs because for the wideband function, decibel levels are computed for a 50Ω load, and for the standard ac function, decibel levels are computed for a 600Ω load.*

**4-31. Variable Phase Output**

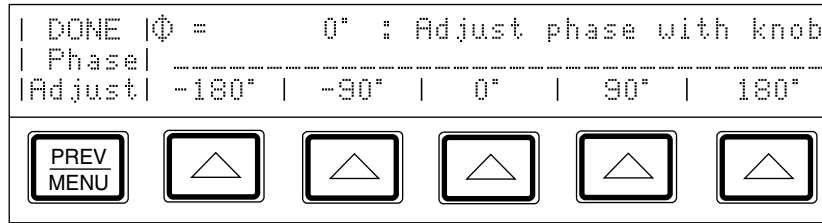
A variable-phase signal of nominally 2.5V rms is available at the rear panel BNC connector labeled VARIABLE PHASE OUT when sourcing ac V, wideband voltage, or ac current outputs. The phase of this signal with respect to the main output signal is continuously adjustable from -180° to +180° in 1° increments. The rotary knob and softkeys adjust the phase of this signal, after calling up the phase controls menu using a softkey. The Control Display shows the phase of the phase output signal as a number and a cursor on a linear scale graduated in 90° steps from -180° to +180°.

To set and adjust a phase output, proceed as follows:

1. Set an ac voltage or current output as described under “AC Voltage or Current Output.”
2. Press the “Phase Ctrls Menu” softkey. The Control Display appears as shown below:



3. Press the “Adjust Phase Shift” softkey. A cursor on the display shows the phase shift of the variable phase output signal:



4. To quickly select a multiple of 90°, press the appropriate softkey.
5. To select a phase output between -180° and 180° (including all intermediate positions), turn the rotary knob to move the cursor to the desired position on the scale. The Control Display shows the phase angle in ± degrees.
6. Press the “DONE Phase Adjust” softkey.
7. Press the “Phase Shift” softkey so “ON” appears. The “(∅-SHF” annunciator lights indicating that variable phase output is on. The variable-phase reference signal stays on after you leave the phase controls menu, and even when you switch between current and voltage. It is turned off when you switch to a dc or ohms function.
8. To reactivate the numeric keypad for controlling the output, press the “DONE Phase Ctrl’s” softkey.

### **4-32. Phase Locking to an External Signal**

The phase-lock feature locks the calibrator's main output signal in phase with an external signal (1 to 10V rms at 10 Hz to 1.2 MHz) applied to the rear panel PHASE LOCK IN BNC connector. You can use this feature with ac V, wideband voltage, or current outputs, and combine it with variable phase output. You access the softkey that turns on phase locking through the phase controls menu. To lock onto an external signal, proceed as follows:

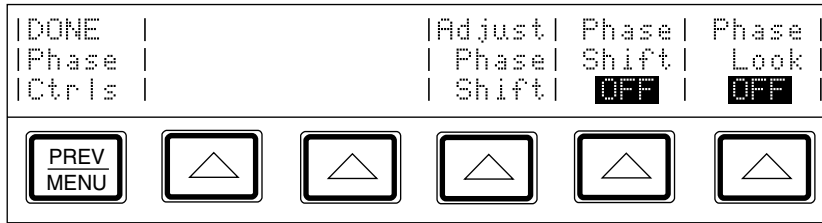
1. With the external signal source turned off, connect a coaxial cable between the external signal source and the rear panel PHASE LOCK IN BNC connector.

*Note*

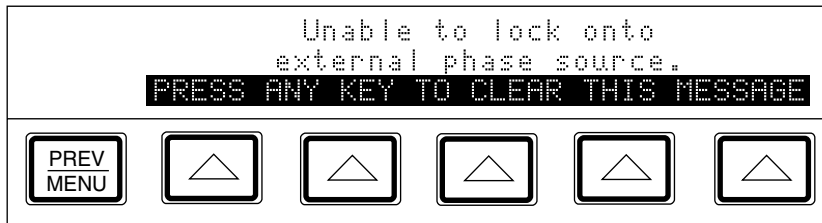
*When using PHASE LOCK IN, make sure the phase lock source is floating relative to the calibrator's output. Ground loops that can occur if the two devices are not isolated can cause amplitude errors in the calibrator's output. These errors may be particularly significant in the millivolt ranges.*

2. Set an ac voltage or current output as described under “AC Voltage or Current Output.”

- Press the “Phase Ctrl’s Menu” softkey. The Control Display appears as shown below:



- Turn on the external signal source.
- Set the calibrator’s frequency to within 2% of the external source frequency.
- Press the “Phase Lock” softkey. This locks the calibrator's main output signal in phase with the external signal applied to the rear panel PHASE LOCK IN BNC connector. When phase locking is successful, the (Ø)-LOCK annunciator on the Output Display lights.
- Observe the Control Display. If the calibrator cannot lock onto the external signal for any reason, it displays the following message:



- To reactivate the numeric keypad for controlling the output, press **PREV MENU**. Phase locking remains active until you change the frequency or turn off phase lock using the “Phase Lock” softkey.

### 4-33. Using an Auxiliary Amplifier

You can increase the output capability of the calibrator by using an auxiliary amplifier. The calibrator has rear panel connectors that interface with four different amplifiers. Three amplifiers can be connected to the calibrator simultaneously, but only one amplifier can be designated as the voltage boost and one amplifier as the current boost in the setup menu. (And only one output can be active at a time.) Table 1-1 shows the ranges and functions supported by the 5725A. The choice of active amplifier and be changed dynamically in a remote system, since such systems can control any front panel function.

During boost operation, you operate the amplifier from the calibrator’s front panel. The calibrator computes and supplies the correct excitation voltages to drive the amplifier. The Output Display on the calibrator always shows the actual output of the amplifier, not the excitation output of the calibrator. In general, the amplifier is activated automatically by selecting an output amplitude only available in its range. In some cases, **BOOST** is used to activate and deactivate the selected amplifier. Refer to the following text for specific operation instructions for each type of amplifier.

### 4-34. 5725A Amplifier Output



#### ⚠ Warning

**Boosted voltage operation produces high voltage at higher current levels than normally available from the calibrator. During boosted voltage operation, the potential risk of injury or fatal accident is greater than during normal operation.**

#### *Note*



*Refer to the 5725A Instruction Manual for setup and installation instructions.*


The 5725A Amplifier boosts ac voltage and both ac and dc current. Proceed as follows to set a boosted output from the 5725A Amplifier:

1. Install the 5725A if you have not already done so as described in the 5725A Instruction Manual.
2. If the “Boost Amp Types” setting in the setup menus has been changed from the default, select the 5725A for boost operation as described at the beginning of this chapter.
3. Make sure the calibrator and 5725A are in standby (STANDBY annunciator lit). Press  if necessary.
4. If the UUT is not connected, connect it now as described earlier in this chapter under “Connecting the Calibrator to a UUT.” Note that for boosted current, you connect to the 5725A binding posts, and for boosted voltage, you connect to the calibrator’s binding posts.
5. Set the UUT to read the appropriate quantity.
6. Enter the desired output value as described under “Setting the Output.” Current entries beyond the standard range of the calibrator automatically select the amplifier. Voltage entries in the 220-1100V range automatically select the amplifier. Note that the 5725A takes over the 1100V range of the calibrator.
7. Boosted voltage output is available at the front or rear panel of the calibrator (depending on which set of terminals is active). Boosted current output is available at the front panel of the 5725A Amplifier. When the 5725A binding posts are selected, the Control Display announces the output location. If your entry has caused a change of output location, you must press  to activate the amplifier.



- When the “Range” softkey is set to “AUTO”, the amplifier automatically turns off whenever a current level within the range of the calibrator is set. Setting the “Range” softkey to “LOCKED” disables this auto shut-off, so you can use the amplifier at lower current levels.

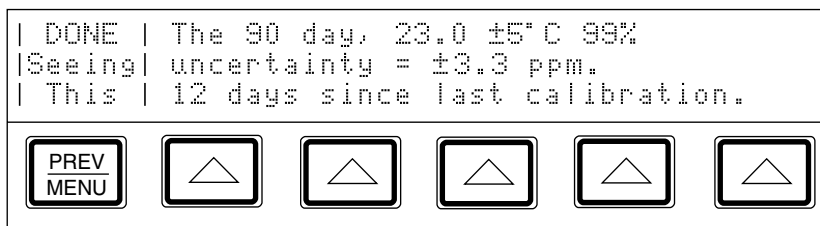
*Note*

*You can have the 5725A source a current below 2.2A to take advantage of the amplifier's higher compliance voltage. To do so, press the “Range” softkey to lock onto the 11A range when the calibrator is set for over 2.2A, or set the lower current and press   to turn on the amplifier.*

- To deactivate the amplifier, press  again.

### 4-35. Checking the Calibrator’s Uncertainty Specification

At any time during front panel operation, you can display the uncertainty specification of the present output of the calibrator by pressing , which opens a display similar to the one shown below. To return to normal operation, press .





### 4-36. Error Mode Operation

The output adjustment controls (arrow keys and the rotary knob) are used to adjust the output of the calibrator incrementally (except in the resistance function). While this happens, the Control Display computes and displays the difference between the adjusted output and the reference level in ±% or ±ppm (parts per million). The reference level is the original output setting before you adjusted it. When this capability is used to adjust the output until the UUT reads correctly, the displayed difference is the UUT error for that output setting. The error is displayed in ±% unless it is ±20 ppm or less.

For example, suppose you set the calibrator to output 10.00000V, and the UUT reading is high. To determine the error, use the output adjustment controls to adjust the calibrator until the UUT reads 10.0000V. If, for example, the calibrator’s output display now reads 9.993900, the calibrator calculates and displays a UUT error of +0.0610% on the control display.

The calibrator uses this formula to calculate the UUT error:


$$\text{Error} = \frac{(\text{Reference}) - (\text{Final Output})}{(\text{Reference})} \times 100\%$$

The rotary knob is also a convenient way to change the frequency during ac voltage testing. To adjust frequency in error mode, for example when testing a meter's flatness, press . The 10 Hz digit of the frequency line is highlighted. Press  twice. Now when you turn the knob, the output frequency increases or decreases 1 kHz per knob click.

### 4-37. Error Mode Overview

The Error Mode Overview explains how to use error mode in general. Following the overview, a step-by-step procedure explains how to use this mode to read UUT error for each of the calibrator’s output functions.










### 4-38. Entering Error Mode

Activate error mode by rotating the rotary knob, pressing an arrow key, or pressing . When you enter error mode, the starting value is the reference from which errors are computed. A new reference is established when you exit and reenter error mode (see Table 4-4 for a summary).


### 4-39. Exiting Error Mode




Table 4-3 lists the actions that cause the calibrator to exit error mode.

**Table 4-3. Keys that Exit Error Mode**



Keys	Action
	Returns to the previous reference value.
	Establishes a new reference.
A new keypad entry + 	Establishes a new reference.
	Establishes the present output as a new reference.
	Establishes a new reference that is equal to ten times the previous reference value.
	Establishes a new reference that is equal to one tenth of the previous reference value.
	Identifies the present output as a zero-scale endpoint for scaling and establishes 0.0 as the new reference.
	Identifies the present output as a full-scale endpoint for scaling and causes the display to show scale error.
	Returns to the power-up state.
The “Setup Menus” Softkey	Opens the Setup menu.

#### 4-40. Using Error Mode

When you enter error mode from any output function except resistance, the least significant digit on the Output Display is highlighted. Entering error mode by pressing  selects the frequency line for adjustment first (but only if the frequency is not zero).

When you turn the rotary knob, the highlighted digit increments or decrements. Turning the knob clockwise makes the number more positive; turning the knob counterclockwise makes the number more negative. As you increment a digit past 9 or decrement a digit past 0, the adjacent digit carries.  and  select digits to the right and left, and  selects the upper line (amplitude) and lower line (frequency).



If you attempt to adjust the output beyond the capability of the calibrator, the calibrator beeps and does not allow the change.

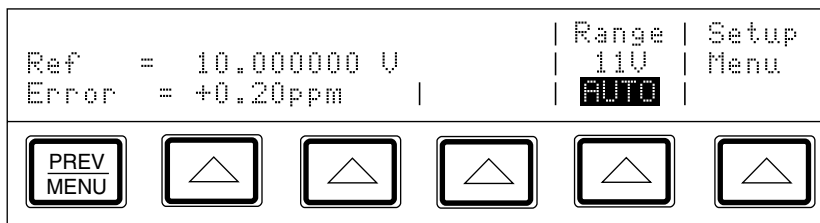
You can quickly verify accuracy of different ranges of a UUT by pressing  and . When you are in error mode and you press these keys, the calibrator's output and the new reference are set to 10 times or one tenth the previous reference value.

In the resistance output function, the edit controls produce a display of the UUT error in a similar way, except the output of the calibrator does not change as you turn the knob. Instead, a reading on the Control Display changes, allowing you to match it to the reading on the UUT. As you change the reading, the calibrator computes and displays UUT error.

#### 4-41. Reading the UUT Error: AC and DC Voltage and Current Output



Proceed as follows to read the error of the UUT in the ac and dc voltage and current output functions:

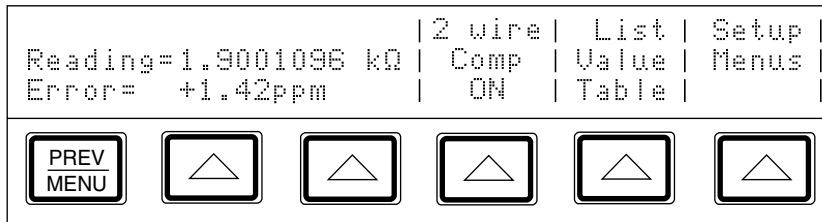
1. Set the desired calibration voltage or current, as previously described under "Setting the Output."
2. Use the output adjustment controls as required to achieve a reading on the UUT equal to the original entry on the calibrator. To increment or decrement a higher-order digit, press . As you approach the reference value, work progressively back towards the LSD (least-significant digit) on the calibrator's output display as necessary by pressing . You only need to go one digit past the LSD of the UUT; digits below that are beyond the resolution of the UUT. The UUT error appears on the Control Display as shown: (This example assumes that the calibrator is in the dc voltage function.)



**4-42. Reading the UUT Error: Resistance Output**

Proceed as follows to read the error of the UUT in the resistance function:

1. Set the desired resistance output as described under “Setting the Output.”
2. Use the output adjustment controls as required to achieve a reading on the Control Display (illustrated below) equal to the reading on the UUT. To adjust a higher-order digit, press . As you approach the reference value, work progressively back towards the LSD (least-significant digit) on the calibrator’s Control Display as necessary by pressing . You only need to go one digit past the LSD of the UUT; digits below that are beyond the resolution of the UUT.



### 4-43. Introduction to Offset, Scale, and Linearity Errors

The performance of a DMM or meter can be plotted as a graph of input stimulus and meter reading. For a perfect meter, the graph of the input stimulus would exactly match the graph of the reading.

The calibrator measures and displays the following three types of UUT errors:

- Offset Error
- Scale Error
- Linearity Error

### 4-44. Offset Error

Offset error can be measured directly by finding the calibrator's output that causes a meter reading of 0V. This error is called an offset because it reflects a fixed error that is present in all meter output readings. For example, if a meter reads 0V when -1.3 mV is applied, the meter has an offset error of +1.3 mV. Figure 4-7 illustrates this example.

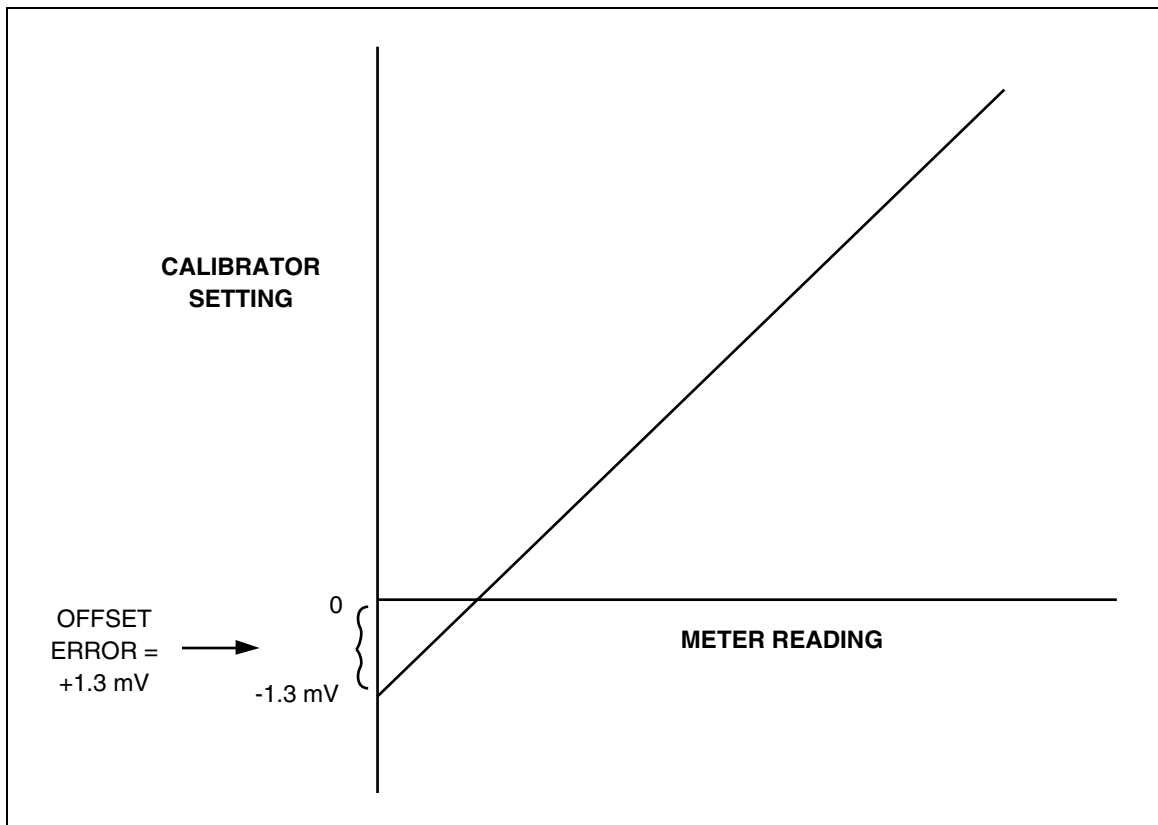


Figure 4-7. Offset Error

**4-45. Scale Error**

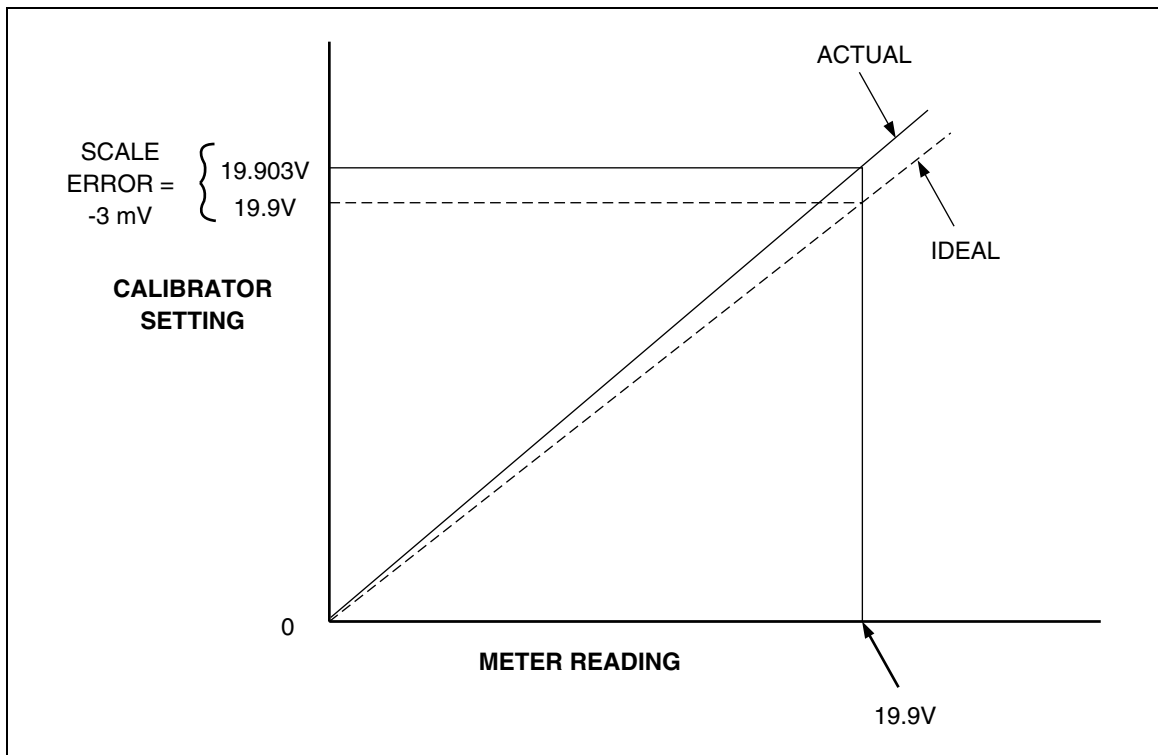
Scale error, sometimes referred to as gain error, occurs when the slope of the meter's response curve deviates from one. A meter with only scale error (no offset or linearity error), will read 0V when 0V is applied, but will read something other than 10V when 10V is applied. For example, if a meter reads 19.900V when 19.903V is applied, the meter has a scale error of -3 mV. To isolate scale error, offset error must first be subtracted. Scale error is then simply the error measured near the full-scale endpoint, or:

$$\text{Scale Error} = \frac{(\text{Reference full scale}) - (\text{Adjusted Calibrator Setting})}{(\text{Reference full scale})}$$

Where “Adjusted calibrator setting” is the adjusted output (using the knob) that results in the UUT correctly reading “nominal full-scale.” Select a point just down from the UUT full-scale endpoint for nominal full-scale. This keeps the UUT from ranging while you make adjustments. For example, you might use 19.9V as the nominal full-scale for a UUT that ranges at 20V.

The example in Figure 4-8 assumes no offset error. The formula for scale error yields:

$$\text{Scale Error} = \frac{19.9 - 19.903}{19.9} = -0.000151 = -0.0151\%$$



**Figure 4-8. Scale Error**

### 4-46. Linearity Error

Linearity error occurs when the response curve of a meter deviates from a straight line. This type of error is measured by fixing zero and near-full-scale endpoints on the response curve, drawing a line through the points, then measuring how far the meter response deviates from the straight line at various points. The error value is computed relative to the selected full-scale point. The formula for linearity error is:

$$\text{Linearity Error} = \frac{(\text{Nominal setting}) - (\text{Adjusted 5720A setting})}{(\text{Nominal full scale})}$$

Where the “nominal setting” is calculated by subtracting the offset error and a proportional part of the scale error.

Figure 4-9 illustrates linearity error with both offset and scale errors assumed to be zero. The formula for linearity error yields:

$$\text{Linearity Error} = \frac{10.0 - 9.993}{19.9} = 0.000352 = +0.0352\%$$

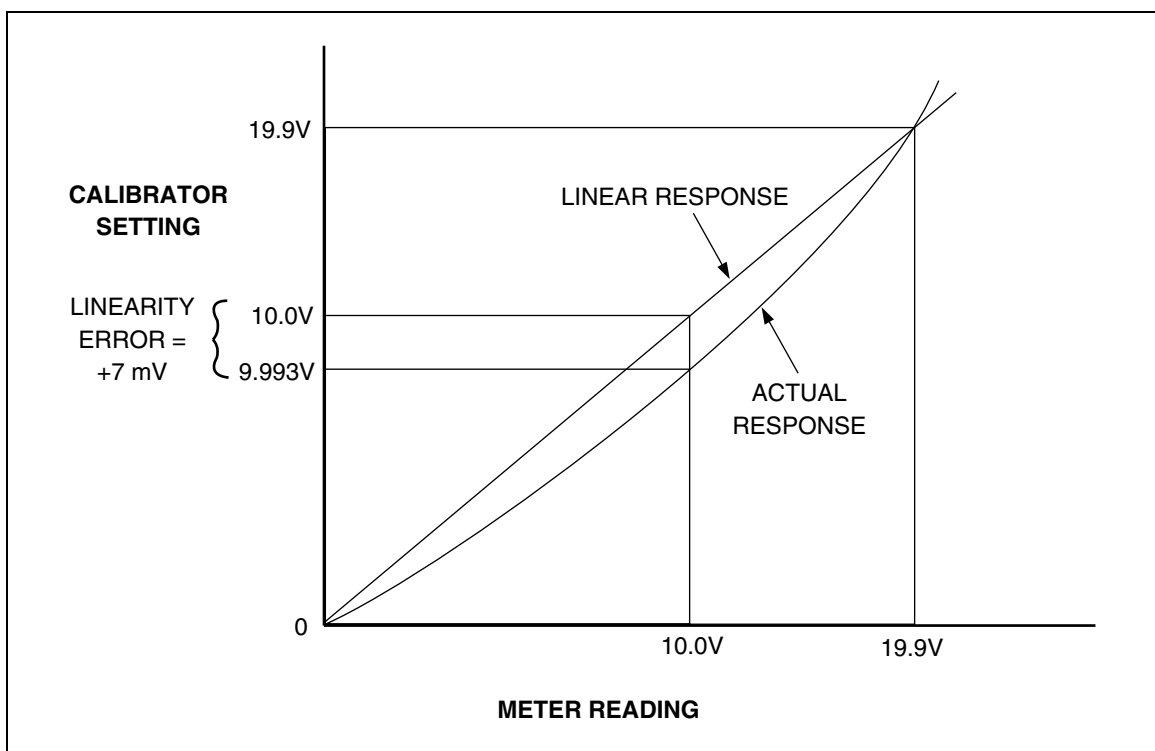


Figure 4-9. Linearity Error

### 4-47. Combining the Error Types

The actual error of a meter is the combination of all three types of errors. The calibrator uses `OFFSET` and `SCALE` to allow you to separately display all three types of errors directly, without having to do any calculation.

### 4-48. Programming an Offset

You can use **OFFSET** when in the dc voltage or current function any time you want to offset the calibrator's output by a fixed amount. After you establish an offset, it is subtracted from all later keyboard entries to compensate for a UUT's offset error. You turn off this offset by pressing **OFFSET** again. Both the offset value and the keypad-entered reference value are shown on the Control Display. The Output Display shows the true output value.

The **OFFSET** key may be used to establish a zero-scale endpoint, which you can then use with **SCALE** to check the linearity of a UUT. (See the example under "Linearity Checking Using Offset and Scale.")

To program an offset, proceed as follows:

1. Set the calibrator to output 0 mV dc in operate mode. The easiest way to do this is to press **RESET**, then press **OPR STBY**.
2. Adjust the calibrator's output with the rotary knob (and arrow keys if necessary) until the UUT reads 0V.
3. Press **OFFSET**. This stores the output value as the offset value.

The calibrator's output value is now 0V minus the offset value, in this example, the 1.3 mV output value is shown on the Output Display. The calibrator's reference value is set to 0V. The reference value is shown on the top line of the Control Display. The offset value is shown on the second line of the Control Display. After step 2, the Control Display and Output Display look like this:

#### Output Display

```
- 1.30000 mV
```

#### Control Display

Offset =	1.30000 mV	Range	Setup
Ref =	0.00000 mV	200mV	Menus
		<b>AUTO</b>	

If you enter a new value, the offset value is subtracted from the new value to create the new output. The newly entered value becomes the new reference value shown on the middle line of the Control Display. For example, if you enter 1V, the Output Display shows +0.9987000V while the Control Display shows "Ref = 1.0000000V". The offset value remains in effect until you press **OFFSET** again, turn off the power, select a different output function (for example, changing from voltage to current output), or press "Setup Menus".

## 4-49. Programming a Scale Factor

You can use the **SCALE** key in ac and dc voltage and current functions to apply a scale factor to subsequent outputs. After you establish a scale factor, the correct proportion of it is applied to all subsequent entries to compensate for a UUT's scale error. You turn off this scale factor by pressing **SCALE** again. Both the scale error and the keypad-entered value are shown on the Control Display. The Output Display shows the true output value.

The **SCALE** key may be used to establish a reference full-scale endpoint, which you can use with **OFFSET** to check the linearity of a UUT. (See the example under “Linearity Checking Using Offset and Scale”.)

To program a scale factor, proceed as follows:

1. Set the calibrator to output a level just below the UUT full-scale endpoint. For example, you might use 19.9V for a UUT that ranges at 20V.
2. Adjust the calibrator's output with the rotary knob (and arrow keys if necessary) until the UUT reads the selected output level correctly (19.9V in this example).
3. Press **SCALE**. This stores a scale factor that would apply this adjustment if this output level were selected again.

Subsequent calibrator output values will be scaled by this factor. Using the example of Figure 4-8, the meter reading was 3 mV low at 19.9V. To compensate, the calibrator was adjusted to 19.003V to get a reading of 19.9V on the meter. Note that the calibrator is adjusted in the opposite direction of the meter's scale error. So, a factor computed in the following equation is applied to subsequent calibrator's output settings until **SCALE** is cleared:

$$1 - \frac{19.9\text{V} - 19.903\text{V}}{19.9\text{V}} = 1.000151$$

Extending this example, if you now set the calibrator to 10V, the actual output (showing on the Output Display) is 10.00151V.

### 4-50. Linearity Checking Using Offset and Scale

Using the calibrator's offset and scaling features, you can remove a UUT's offset and scale errors to isolate and display linearity error. The following procedure is an example that uses **OFFSET** and **SCALE** to determine both scale and linearity error of a 4 1/2-digit DMM. In this example, the DMM is set to the 20V dc range, and the calibrator is connected to the DMM. Figure 4-10 illustrates all three types of errors that are detected by the calibrator. The numbers in the graph correspond to the conditions encountered in the example.

1. Set the calibrator to 0 mV in standby. The displays change to:



2. Use the output adjustment controls (the rotary knob and arrow keys) to adjust the calibrator's output for a reading of 0V on the DMM. The displays change to:

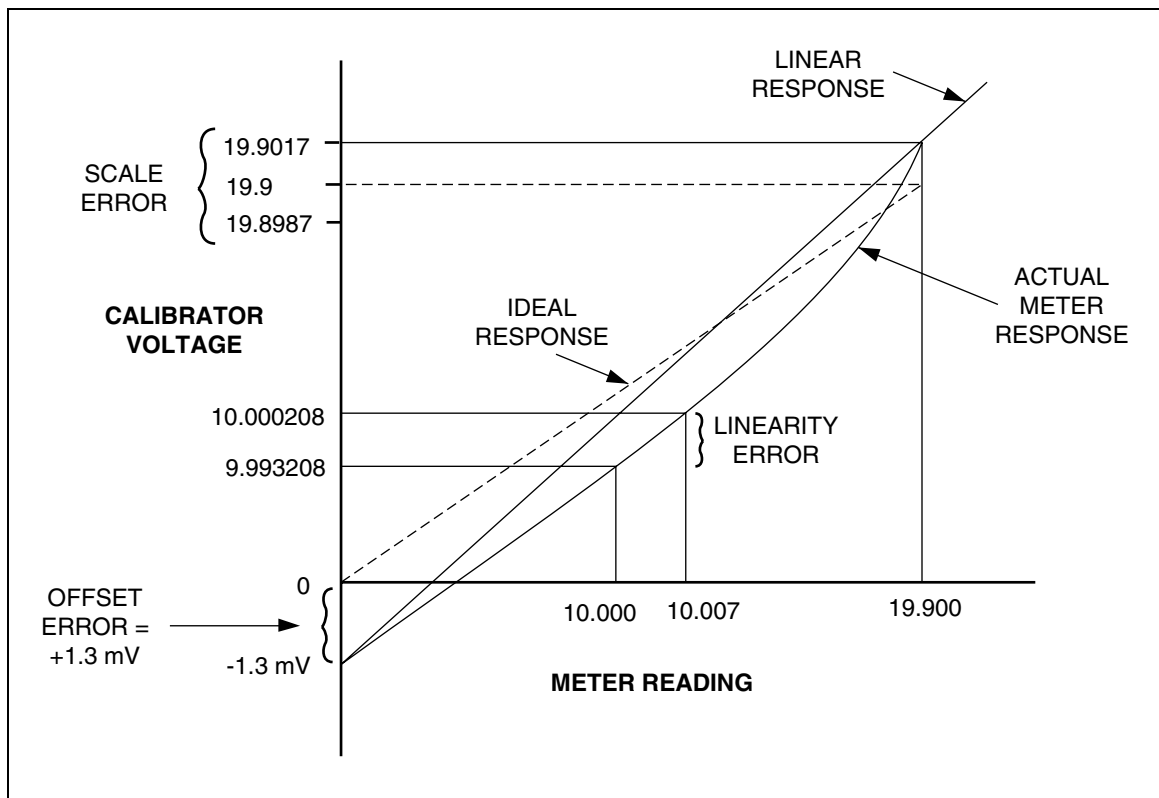
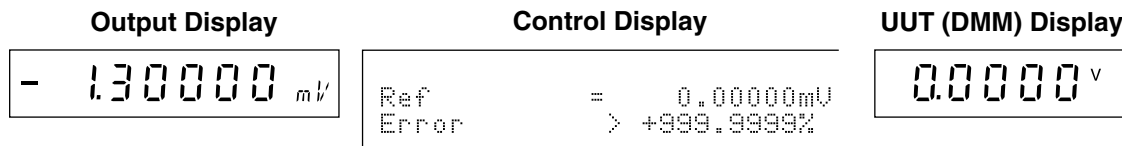
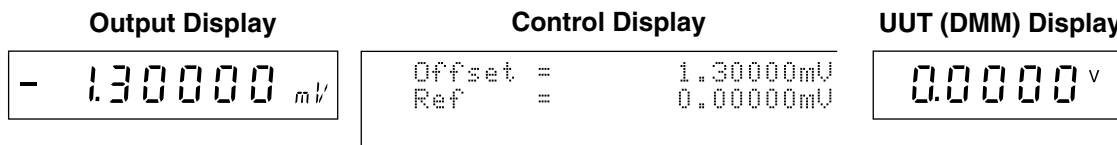


Figure 4-10. Meter Response vs. Stimulus

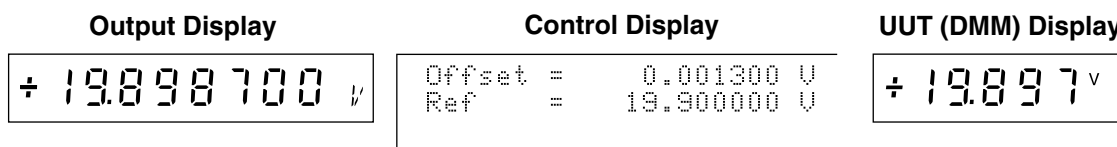
Note

The message "Error >> +999.9999%" occurs because in this case the reference voltage is 0.

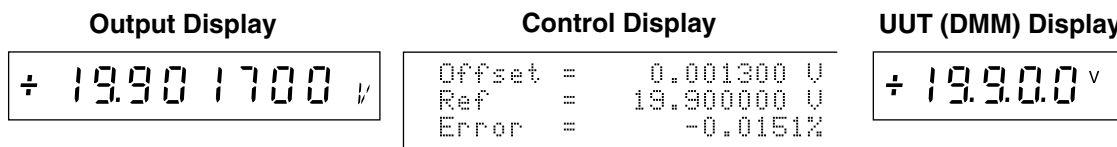
- Press **OFFSET** to identify this as the DMM zero-scale end point. The displays change to:



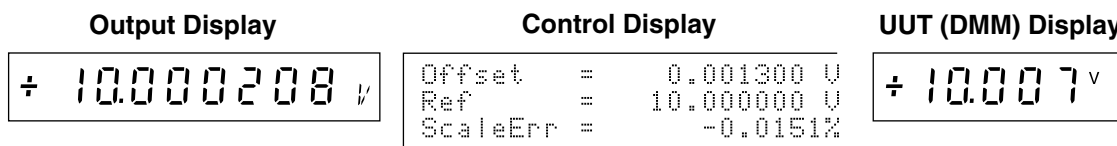
- Use the numeric keypad to set the calibrator to a point near the end of the DMM range. (This example uses 19.9V.) The displays change to:



- Use the output adjustment controls to adjust the calibrator's output for a reading of 19.9V (the reference value) on the DMM. The displays change to:



- Press **SCALE** to identify this as the full-scale endpoint for the DMM range.
- To check the linearity error of the DMM, select an output at a linearity checkpoint somewhere in the middle of the range, such as 10V. Entering 10V changes the displays to:



The 10.000208V output setting is calculated by the calibrator using the following equation:

$$1 - \frac{19.9\text{V} - 19.903\text{V}}{19.9\text{V}} = 1.0001508$$

This is applied to 10V to yield the following:

$$10\text{V} \times 1.0001508 = 10.001508\text{V}$$

The 1.3 mV zero offset is then subtracted:


$$10.001508\text{V} - 0.0013\text{V} = 10.000208\text{V}$$

8. Use the output adjustment controls to adjust the calibrator's output for a reading of 10.0V (the reference value) on the DMM. The displays change to:


Output Display	Control Display	UUT (DMM) Display
<div style="border: 1px solid black; padding: 5px; display: inline-block;"> <math>\div</math> 9.993208 <math>\mu</math> </div>	<div style="border: 1px solid black; padding: 5px; display: inline-block;">           Offset = 0.001300V            Ref = 10.000000V            LinError = +0.0352%         </div>	<div style="border: 1px solid black; padding: 5px; display: inline-block;"> <math>\div</math> 10.00.0 <math>\mu</math> </div>


The Control Display now shows that the DMM scale error at 19.9V is -0.0151%, and the DMM linearity error at 10V is +0.0352%.

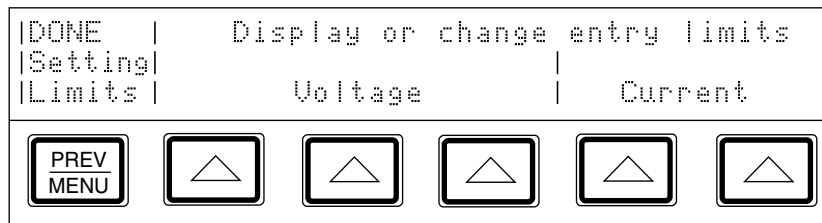
## 4-51. Setting Output Limits

An output limit feature is available to help prevent accidental damage to a UUT from overcurrent or overvoltage conditions. This feature allows you to preset the maximum positive and negative allowable voltage or current output. Entry limits you set prevent any input greater than the limit from being activated by entry through the front panel keys or the output adjustment controls. Positive limits for voltage and current set the limits for ac voltage and current. Default entry limits after power-up or  are the specified maximum and minimum for each output function.

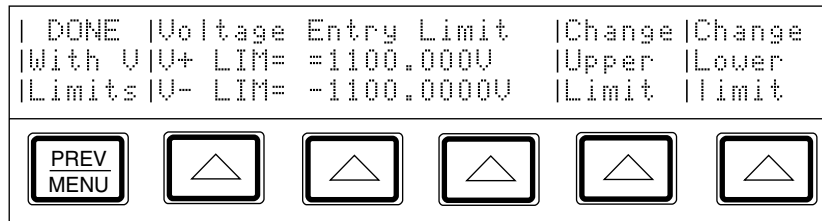
## 4-52. Setting Voltage and Current Limits





To set voltage and current entry limits, proceed as follows from , the power-up state, or any direct operation menu:

1. Press . The display changes to:



2. Press one of the softkeys under “Voltage.” The display changes to:



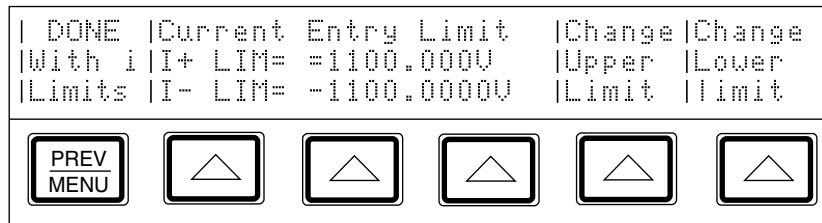
3. Press the “Change Upper Limit” or the “Change Lower Limit” softkey, then press the numeric keys for the desired voltage limit and , , or  if necessary, followed by .

### Note

The upper voltage limit sets the limits for both dc and ac voltage.

4. Press .

- To display or change the current entry limits, press one of the softkeys under “Current.” The display changes to:



- Press the “Change Upper Limit” or the “Change Lower Limit” softkey, then press the numeric keys for the desired current limit and  $\mu$ , m, or k if necessary, followed by .

*Note*

*The upper current limit sets the limit for both dc and ac current.*

- Press  twice.

### 4-53. Sample Applications

Sample methods for approaching a few selected applications are provided here. Included are the following:

- Calibrating a Fluke 70 Series 3½ digit handheld multimeter
- Calibrating a Fluke 8840A Series 5½ digit multimeter
- Testing the flatness of a wideband voltmeter

### 4-54. Calibrating Fluke 70 Series Multimeter

For many users, calibrating a handheld DMM is a major part of the calibrator’s workload. This example goes through the steps necessary to calibrate a Fluke 70 Series Multimeter.

*Note:*

*These procedures are included here as an example. The 70 Series Service Manual contains the authoritative testing and calibration procedures for 70 Series meters.*

Two procedures are described here. The first tests each function and range for compliance to specifications. The second is the calibration procedure for the 70 Series meters. The *70 Series Service Manual* gives instructions for disassembly and access to the pca (printed circuit assembly). You will need to access the pca for the calibration procedure.

Before connecting the calibrator to the 70 Series Multimeter (hereafter referred to as "the meter"), you need to determine what type of cables to use and whether to use internal or external guarding and sensing. This decision-making process is covered next.

#### **4-55. Cables**

According to the text under “Connecting the Calibrator to a UUT,” the 5440A-7002 (banana plugs) or 5440A-7003 (spade lugs) Low-Thermal Cables are recommended for:

- All DC voltage
- All resistance
- AC voltage <10 kHz
- AC current  $\leq 2 \text{ A} \leq 0 \text{ kHz}$
- DC current  $\leq 2 \text{ A}$

Since all of the 70 Series tests include these functions, you should use the 5440A-7002 or 5440A-7003 Low-Thermal Cables, if possible. However, the thermal emf errors that the Low-Thermal cables are designed to reduce are not significant when calibrating a 3½ digit meter. Therefore, if you have the recommended Low-Thermal Cables, use them. Otherwise, ordinary insulated test leads will suffice.

#### **4-56. Guarding**

Because the 70 Series Multimeters are battery operated, their inputs have no connection to earth ground. Therefore, setting the calibrator to internal guard is appropriate.

#### **4-57. Sensing**

External sensing is required only when the voltage drop in the cables is significant. The following data determines the significance of the voltage drop in the cables:

- The input impedance of the 70 Series Multimeters is 10 MΩ.
- The total resistance of the Model 5440A-7002 Low-Thermal Cables is 30 mΩ.
- The basic dc voltage accuracy of the most accurate of the 70 Series, the Model 77, is 0.3%.

The percentage of error caused by voltage drop in the cables is:

$0.3 \times 100/10,000 = 0.003\%$ , or 1/100th of the accuracy of the Model 77.

This voltage drop is not significant, so a two-wire connection (Internal Sense) is appropriate.

### 4-58. Testing the Meter

You can use the error mode feature of the calibrator to test the meter. To verify that all ranges of all functions are within specifications, proceed as follows:

1. Turn on the calibrator and allow it to warm up.
2. Execute dc zeros calibration. Do this by pressing the following sequence of softkeys: “Setup Menus” → “Cal” → “Zero”
3. Press **PREV MENU** twice to get out of the calibration menu.
4. Verify that the EX GRD and EX SNS indicators are off; if either is lit, press **EX SNS** and **EX GRD** as necessary.
5. Test the dc voltage function as follows:
  - a. Verify that the calibrator is in standby and connect the meter as shown in Figure 4-11.
  - b. Turn on the meter and set its function switch to dcV.
  - c. Set the warmed up calibrator to 2.7V dc. Press **OPR STBY**.
  - d. Use the output adjustment controls to adjust the calibrator’s output for a reading of +2.70 on the meter.
  - e. Verify that the error shown on the control display is less than the specification for the meter (see the service manual for the specifications).

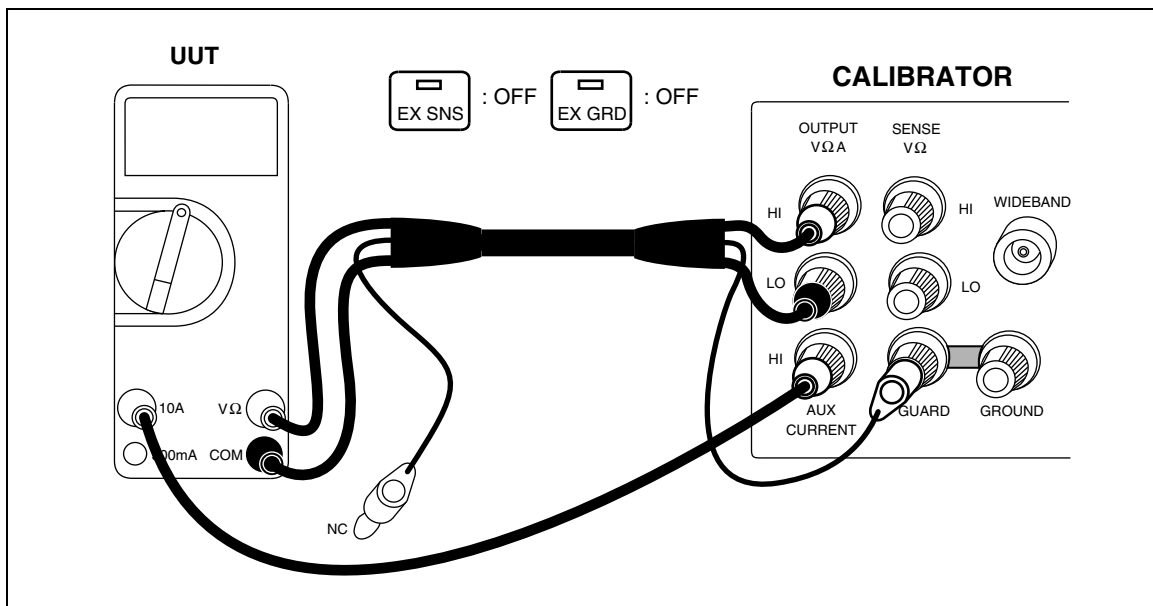


Figure 4-11. Cable Connections for Testing a Fluke 70 Series Multimeter

- f. Check the meter error at 27V and 270V. Hint: use **X10**. See if the errors are within specification. When **X10** causes the output to go over 22V, the calibrator goes into standby. When this happens, press **OPR STBY** to operate.

- g. Check the meter error at 1000V. See if it is within specification.
    - h. Press  on the calibrator, verify that the STANDBY annunciator is lit, and set the meter function switch to 300 mV.
    - i. Check the meter error at 300 mV. See if it is within specification.
  6. Test the ac voltage function:
    - a. Press  on the calibrator and set the meter function switch to acV.
    - b. Check the error against specifications at the following voltages and frequencies:

Voltage	Frequency
2.7V	100 Hz
2.7V	500 Hz
750V	100 Hz
750V	1000 Hz
  7. Test the dc current function:
    - a. Press  on the calibrator and set the meter function switch to dcI.
    - b. Set the calibrator to 1.99A but do not press  yet.
    - c. Press the “Currnt Output” softkey until the AUX label appears.
    - d. Press  on the calibrator.
    - e. Use the output adjustment controls to adjust the calibrator’s output for a reading of +1.99 on the meter.
    - f. Verify that the error shown on the control display is within specification.
    - g. Set the meter function switch to 300 mA, move the current lead to the 300 mA terminal, and check the error at 27 mA and 200 mA.
  8. Test the resistance function:
    - a. Press  on the calibrator and set the meter function switch to ohms.
    - b. Set the calibrator to 100Ω and press .
    - c. Press the “2 wire Comp” softkey to turn on two-wire lead-drop compensation.
    - d. Use the output adjustment controls to adjust the calibrator’s output until the reading on the Control Display is the same as the reading on the meter.
    - e. Verify that the error is within specification.
    - f. Repeat steps d and e for the following values, leaving two-wire compensation turned on for 1 kΩ and 10 kΩ only:  
1 kΩ, 10 kΩ, 100 kΩ, 1 MΩ, 10 MΩ
  9. Press  on the calibrator. Meter testing is complete.

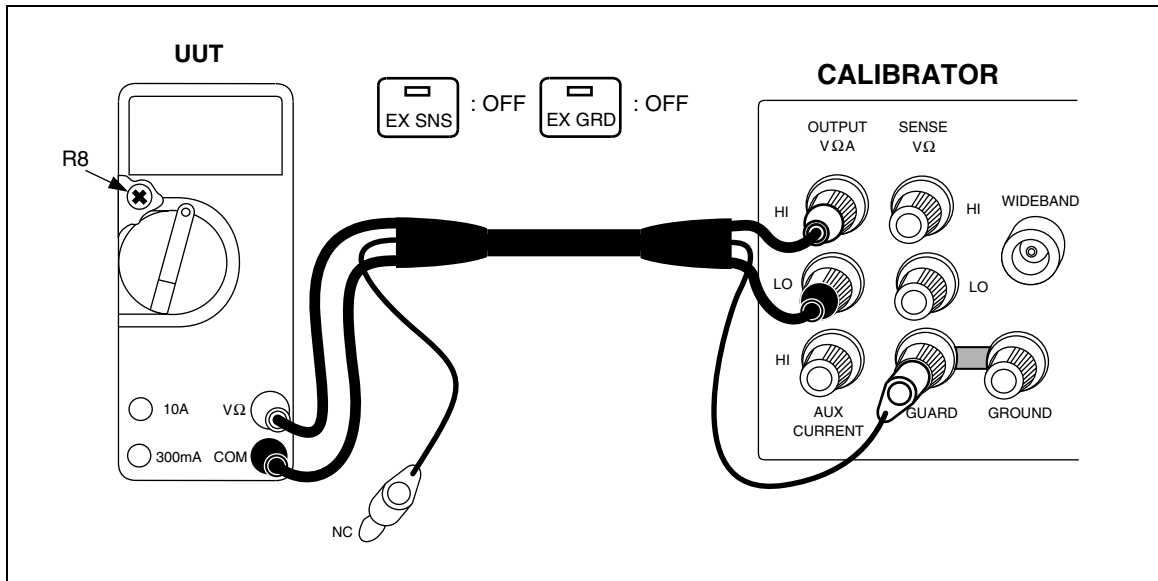
#### 4-59. *Calibrating the Meter*

Continue with calibration if any range was out of tolerance in the previous procedure.

*Note*

*The adjustment for calibrating the meter requires disassembling the meter. Refer to the diagrams and access procedures in the 70 Series Service Manual.*

1. Verify that the calibrator is set to 0V dc in standby. Press  if it is not.
2. Turn on the meter, and set its function switch to dcV.
3. Connect a set of test leads to the meter as shown in Figure 4-12.
4. Set the calibrator to 3V dc and press .
5. Adjust R8 (located just to the left of the rotary switch on the pca) in the meter for a display reading of +3.00V dc  $\pm$ .001V.
6. Press  on the calibrator. Disconnect and turn off the meter. Calibration is complete.



**Figure 4-12. Cable Connections for Calibrating a Fluke 70 Series Multimeter**

#### **4-60. Calibrating a Fluke Model 8840A Series Digital Multimeter**

This example calibrates a 5-1/2 digit Fluke 8840A DMM. Procedures used in this example are for illustrative purposes. For the authoritative and complete calibration procedures for the 8840A, refer to the *8840A Instruction Manual*.


#### **4-61. Cables**

According to the text under “Connecting the Calibrator to a UUT,” the 5440A-7002 or 5440A-7003 Low-Thermal Cables are recommended for:

- All dc voltage
- All resistance
- AC voltage < 10 kHz
- AC current  $\leq 2A \leq 10$  kHz
- DC current  $\leq 2A$

Since all of the 8840A tests include these functions, you should use the Low-Thermal Cables. The 8840A’s outputs all have recessed banana connectors, so use the 5440A-7002 Low Thermal Cables, which have banana plugs.

#### **4-62. Guarding**

The 8840A inputs are not grounded, so you should establish the ground point at the calibrator. To do so, set the calibrator to internal guard ( indicator off), and connect the 8840A to the calibrator as Figure 4-13 shows.

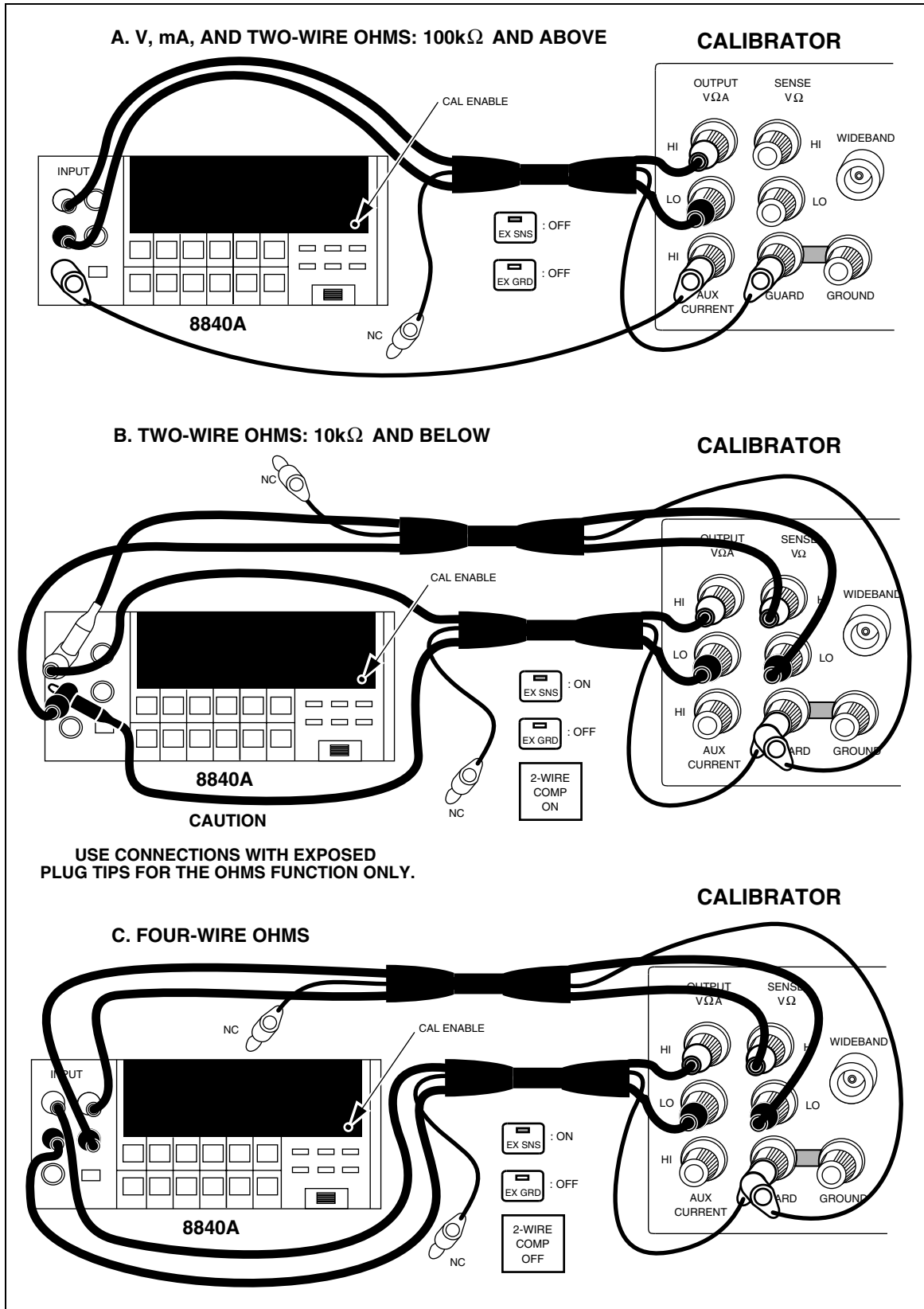


Figure 4-13. 8840A Calibration Connections

### 4-63. Sensing

External sensing is required only when the voltage drop in the cables is significant. The following data determines the significance of the voltage drop in the cables:

- The input impedance of the 8840A is  $\geq 10,000 \text{ M}\Omega$  for ranges up to 20V, and  $10 \text{ M}\Omega$  for the 200V and 1000V ranges.
- The total resistance of the Model 5440A-7002 Low-Thermal Cables is  $30 \text{ m}\Omega$ .

Cable voltage drop is insignificant because this is a high-impedance meter, so in this case internal sensing is appropriate.


External sensing should be used for resistance calibration in the two-wire function, however, so the calibrator's two-wire compensation circuitry can sense at the meter terminals.

### 4-64. Basic Calibration Procedure

The basic calibration procedure consists of the following four parts. These parts must be performed in the order given.

1. Calibration setup procedure
2. A/D calibration
3. Offset and gain calibration for each function and range
4. High-frequency ac calibration (True RMS AC option only)

### 4-65. Calibration Setup Procedure

1. Allow the 8840A to stabilize in an environment with ambient temperature of 18 to 28°C and relative humidity less than 75%.
2. Turn the 8840A on, and allow it to warm up for at least one hour.
3. Turn the calibrator on, and allow it to warm up for at least 30 minutes.
4. Execute dc zeros calibration. Do this by pressing the following sequence of softkeys: "Setup Menus" → "Cal" → "Zero"
5. Press  twice to get out of the calibration menu.
6. Enable 8840A calibration mode by pressing the 8840A CAL ENABLE switch with a small screwdriver or other suitable instrument. (The CAL ENABLE switch is located on the lower right side of the display and is normally covered by a calibration seal.)
7. Verify that the calibrator's STANDBY annunciator is lit and connect the calibrator to the 8840A using Low Thermal Cables as Figure 4-13A shows.

**4-66. A/D Calibration**

The a/d calibration procedure calibrates the analog-to-digital converter for offset, gain, and linearity. The 8840A automatically selects the a/d calibration procedure when the CAL ENABLE switch is first pressed. The procedure must be performed in its entirety, and may not be performed in part. If the a/d calibration is discontinued prior to completion, the last complete set of a/d calibration constants will be retained unchanged.

To perform a/d calibration, proceed as follows:

1. The 8840A displays a prompt for the first reference source, 0V dc (i.e., a short).
2. Each time the 8840A prompts you for a reference source, set the calibrator to the requested value, and press the 8840A STORE button. When you press STORE, the numeric display field blanks while the 8840A performs the necessary calculations. (Do not change the calibrator's output while the display is blank.) The 8840A then displays the next prompt. For reference, all prompts are shown in Table 4-4.

*Note*

*The 8840A automatically checks that the reference input is near the value prompted and displays ERROR 41 if the reference input exceeds a specific tolerance. (See Advanced Features and Special Considerations in the 8840A Instruction Manual for more information.)*

3. After the last input is stored, the 8840A begins taking readings in the 2V range of the VDC function. (The 8840A CAL annunciator remains on.) Verify a/d calibration using settings in Table 4-5. If you wish to repeat the a/d calibration procedure, press the 8840A A/D button.

**Table 4-4. 8840A A/D Converter Calibration Prompts**

Step	8840A Prompt
A	0.OV DC (short)
B	-0.03V DC
C	-1.01V DC
D	+0.99V DC
E	+0.51V DC
F	-0.51V DC
G	-0.26V DC
H	+0.26V DC
I	+0.135V DC
J	-0.135V DC
K	-0.0725V DC
L	+0.0725V DC

Table 4-5. 8840A A/D Calibration Allowable Errors

Step	Calibrator Output	Allowable Error
A	0.0V DC (short)	± 2 counts
B	-0.03V	± 2 counts
C	+0.03V	± 2 counts
D	-0.660V	± 3 counts
E	+0.660V	± 3 counts
F	-1.970V	± 4 counts
G	+1.970V	± 4 counts

The a/d calibration procedure is an iterative process. Each pass through the procedure uses the constants stored previously and improves them. Normally, one pass is adequate. However, if the calibration memory has been erased or replaced, or the a/d converter has undergone repair, the a/d calibration procedure must be performed twice.

Because the a/d calibration procedure is iterative, the instrument's performance can be slightly enhanced by going through the procedure more than twice. However, this is not necessary to meet the 8840A's published specifications.

#### 4-67. Offset and Gain Calibration

The offset and gain calibration procedure calibrates the 8840A's offsets and gains by applying a high and low input for every range of each function. To save time, the 8840A uses each input for as many ranges as possible.

A function is calibrated by pressing the corresponding function button. Once a function is selected, the 8840A automatically steps through each range of that function, prompting you for the necessary calibrator outputs. (The prompts are shown in Table 4-6.) The 8840A does not automatically select another function after one function has been completely calibrated; therefore, the functions may be calibrated in any order.

To perform offset and gain calibration, proceed as follows:

1. Ensure that a/d calibration has been completed.
2. Verify the the calibrator is in standby and connected to the 8840A as shown in Figure 4-13A.
3. Select the 8840A VDC function by pressing the VDC function button. The 8840A displays the first prompt for that function.
4. Each time the 8840A prompts you for a calibrator output, apply this output and press the 8840A STORE button. When you press STORE, the numeric display field blanks while the 8840A performs the necessary calculations. (Do not change the reference source while the display is blank.) The 8840A then displays the next prompt. For reference, all prompts are shown in Table 4-6.

**Table 4-6. 8840A Offset and Gain Calibration Prompts**

Step	Displayed Prompt				
	VDC	VAC (1)	2-Wire kΩ 4-Wire kΩ	mA DC	mA AC (1)
A	+0.00 mV DC (short)	10.0 mV AC	0.00Ω (short)	0.0 mA DC (open)	100 mA AC
B	+190.0 mV DC	100.0 mV AC	100.0Ω	1000 mA DC	1000 mA AC
C	+1.900V DC	1.000V AC	1.000 kΩ	Steps C through G not applicable for these functions.	
D	+19.00V DC	10.00V AC	10.00 kΩ		
E	+190.0V DC	100.0V AC	100.0 kΩ		
F	+1000V DC	500V AC	1000 kΩ		
G	Step G not applicable for these functions		10.00 MΩ		
1. Inputs should be at 1 kHz ±10%. Performance may be enhanced for specific frequencies (see 8840A Operators Manual for more information).					

5. After the last range is calibrated, the 8840A begins taking readings in the highest range so that you may verify its calibration. (The CAL annunciator remains on.) To verify the calibration for the other ranges, press the corresponding range button. (Pressing a function button begins the offset and gain calibration procedure for that function.)

6. Repeat steps 2, 3, and 4 for the remaining functions.

Both two-wire and four-wire ohms functions must be calibrated. (The V ac and mA ac functions require calibration only if the True RMS AC option is installed.)

- To calibrate two-wire ohms 100 kΩ and above, use the connection shown in Figure 4-13A.
- To calibrate two-wire ohms 10 kΩ and below, use the connection shown in Figure 4-13B and turn on the calibrator's two-wire compensation.
- To calibrate four-wire ohms, use the connection shown in Figure 4-13C, turn off the calibrator's two-wire compensation, and press EX SNS so that its indicator is lit.

For the mA ranges, use the connection in Figure 4-13A and set the calibrator's current output binding post to AUX before pressing OPR STBY.

7. When all functions have been calibrated, exit the calibration mode by pressing the 8840A CAL ENABLE switch, and attach a calibration certification sticker over the CAL ENABLE switch. (If the True RMS AC option is installed, instead of attaching the calibration sticker proceed to the High-Frequency AC Calibration procedure which follows.)

### 4-68. High Frequency AC Calibration

The High Frequency AC Calibration procedure calibrates the response of the 8840A ac voltage function from 20 kHz to 100 kHz. If the True RMS AC option is not installed, selecting this procedure results in an error message.

The calibrator's output used in this procedure should normally be between 90 and 100 kHz. An output of 100 kHz (nominal) is recommended. For special applications, performance may be optimized at other frequencies. See "Optimizing AC Calibration at Other Frequencies" in the 8840A Instruction Manual for more information.

To perform high-frequency ac calibration, proceed as follows:

1. Ensure that offset and gain calibration has been completed for the VAC function.
2. Select the High-Frequency AC Calibration procedure by pressing the 8840A HF AC button. The 8840A displays the first prompt (100 mV AC). The "U" on the 8840A display indicates the High-Frequency AC Calibration procedure has been selected.
3. Each time the 8840A prompts you for a reference amplitude, apply this amplitude to the HI and LO INPUT terminals, and press the STORE button. When you press STORE, the numeric display field blanks while the 8840A performs the necessary calculations. (Do not change the reference source while the display is blank.) The 8840A then displays the next prompt. For reference, all prompts are shown in Table 4-7.
4. After the last range is calibrated, the 8840A begins taking readings in the highest range so that you may verify its calibration. To verify the calibration for the other ranges, push the corresponding range button. The CAL annunciator remains on.
5. The calibration procedure is now completed. Exit the calibration mode by pressing the 8840A CAL ENABLE switch, and attach a calibration certification sticker over the CAL ENABLE switch.

**Table 4-7. 8840A High-Frequency AC Calibration Prompts**

Step	8840A Prompt
A	100.0 mV AC
B	1.000V AC
C	10.00V AC
D	100.0V AC
E	200.0V AC

#### 4-69. Performing A Wideband Flatness Test

Wideband rms voltmeters such as the Fluke 8920 Series measure ac voltage into the RF spectrum. One type of error in wideband rms voltmeters is flatness error, or error due to uneven frequency response.

Two example procedures related to wideband flatness are given here. The first example is a procedure to test the flatness or frequency response error of a wideband voltmeter to within the uncertainty of the Wideband AC Module (Option 5700A-03) flatness specification. The second example is a technique that transfers the accuracy of the calibrator's main ac voltage output to the output of the Wideband AC Module at a low frequency, then reads the absolute error of a meter with respect to the flatness specification of the Wideband AC Module at a high frequency.

##### Example 1:

1. Connect the 3-foot cable supplied with the Wideband AC Module to the WIDEBAND connector to the wideband voltmeter input through the supplied 50 $\Omega$  terminator.
2. Set the calibrator's wideband output to 1V at 1 kHz.
3. Adjust the wideband output with the output adjustment controls for a reading of 1.00V on the wideband voltmeter.
4. Press  to establish this as a new reference.
5. Press      to set the frequency to 10 MHz.
6. Adjust the wideband output again with the output adjustment controls for a reading of 1.00V on the wideband meter.
7. The control display now shows the frequency response error to within the uncertainty of the Wideband AC Module flatness specification.

**Example 2:**

1. Connect the main output terminals of the calibrator to the wideband voltmeter input.
2. Set the calibrator's main output to 1V at 1 kHz.
3. Read the meter and record the reading. (Let us assume, for example, that the meter reads 0.999V.)
4. Disconnect the leads from the main output terminals, and connect the the calibrator's WIDEBAND connector to the wideband voltmeter input through the supplied 50 $\Omega$  terminator.
5. Press .
6. Adjust the calibrator's wideband output with the output adjustment controls for the same reading as in step 3 (0.999V in our example). The Wideband AC Module is now sourcing an accurate 1V, referenced to the main output of the calibrator. (This transfers the accuracy specification of the main ac output to the Wideband AC Module at 1V @ 1 kHz.)
7. Press  to establish this as a new reference.
8. Press      to set the calibrator's frequency to 10 MHz.
9. Adjust the calibrator's wideband output with the output adjustment controls for a reading of 1.00V on the wideband meter.
10. The Control Display now shows the absolute (total) error of the wideband meter to within the uncertainty of the Wideband AC Module flatness specification.

# Chapter 5

## Remote Operation

	<b>Title</b>	<b>Page</b>
5-1.	Introduction.....	5-3
5-2.	Using the IEEE-488 Port for Remote Control .....	5-4
5-3.	IEEE-488 Bus Restrictions.....	5-4
5-4.	Bus Setup Procedure.....	5-4
5-5.	Using the RS-232C Port for Remote Control .....	5-5
5-6.	Serial Remote Control Setup Procedure.....	5-6
5-7.	Exceptions for Serial Remote Control.....	5-7
5-8.	Command Syntax Information.....	5-7
5-9.	Parameter Syntax Rules.....	5-8
5-10.	Extra Space Characters .....	5-9
5-11.	Terminators.....	5-9
5-12.	Incoming Character Processing .....	5-9
5-13.	Response Message Syntax.....	5-10
5-14.	Input Buffer Operation.....	5-10
5-15.	Commands .....	5-10
5-16.	Multiple Commands .....	5-11
5-17.	Coupled Commands .....	5-11
5-18.	Sequential and Overlapped Commands.....	5-12
5-19.	Commands Ignored When Not in Remote .....	5-12
5-20.	Commands that Require the Calibration Switch to be Set .....	5-12
5-21.	Long Term Commands.....	5-12
5-22.	Local-to-Remote State Transitions .....	5-43
5-23.	Checking the Calibrator's Status .....	5-45
5-24.	Serial Poll Status Byte .....	5-47
5-25.	Service Request Line (SRQ).....	5-48
5-26.	Service Request Enable Register.....	5-48
5-27.	Loading the SRE .....	5-48
5-28.	Event Status Register.....	5-49
5-29.	Bit Assignments for the ESR and ESE.....	5-49

5-30.	Reading the ESR and ESE .....	5-50
5-31.	Loading the ESE .....	5-50
5-32.	Instrument Status Register.....	5-51
5-33.	Instrument Status Change Register.....	5-51
5-34.	Instrument Status Change Enable Register .....	5-51
5-35.	Bit Assignments for the ISR, ISCR, and ISCE .....	5-51
5-36.	Reading the ISR, ISCR, or ISCE .....	5-52
5-37.	Loading the ISCE.....	5-52
5-38.	Fault Queue .....	5-53
5-39.	IEEE-488 Interface Configuration.....	5-54
5-40.	Bus Communication Overview.....	5-55
5-41.	Definition: Queries and Commands .....	5-56
5-42.	Functional Elements Of Commands.....	5-56
5-43.	Interface Messages .....	5-58
5-44.	The IEEE-488 Connector.....	5-60
5-45.	Remote Program Examples.....	5-61
5-46.	Printing Main Output Calibration Shift Results .....	5-61
5-47.	Verifying a Meter .....	5-62
5-48.	Remote Calibration.....	5-62
5-49.	DC Zeros .....	5-62
5-50.	Calibration.....	5-63
5-51.	Calibration Check .....	5-64
5-52.	Wideband AC Module (Option 5700A-03) Gain Calibration.....	5-65
5-53.	Using *OPC?, *OPC, and *WAI .....	5-66
5-54.	Writing an SRQ and Fault Handler .....	5-67
5-55.	Emulating a Fluke 5100B or 5200A Calibrator.....	5-68
5-56.	Entering Emulation Mode .....	5-68
5-57.	Exiting Emulation Mode .....	5-69
5-58.	The 5720's Display During Emulation.....	5-69
5-59.	5100B Emulation .....	5-69
5-60.	Local-to-Remote Transitions.....	5-69
5-61.	Current Output Location.....	5-70
5-62.	Differences in the 5700A/5720A Series II and 5100B Ohms Function.....	5-70
5-63.	Ohms Remote Program Modifications for 5100B Emulation .....	5-71
5-64.	5200A Emulation.....	5-72
5-65.	Local-to-Remote Transitions.....	5-72
5-66.	Voltage and Frequency Ranges .....	5-72
5-67.	Rounding Numeric Entries .....	5-73
5-68.	Settling Times.....	5-73
5-69.	Programming External Sensing.....	5-74
5-70.	Overload Conditions.....	5-74
5-71.	Phase Lock Errors.....	5-74

## 5-1. Introduction

The calibrator is capable of operating under remote control of an instrument controller, computer, or terminal, as well as under direct local control from the front panel. Remote control can be interactive, with the user controlling each step from a terminal, or can be set up to run automatically, taking commands from a computer within an automated system. This chapter tells you how to connect, configure, and operate the 5700A/5720A Series II in remote mode.

The remote programmer uses a language of commands called “device-dependent commands” to duplicate the functions of the front panel controls.

An alternative language capability is included for users of the Fluke Model 5100B. It lets the 5700A/5720A Series II emulate a 5100B in response to commands and allows substituting either one of these calibrators into a 5100B system with no, or in some cases minor, software modifications.

### Note

*If you own a previous version of the 5700A calibrator, you can use its remote programs to operate the 5700A/5720A Series II.*

### **⚠ Warning**

**The calibrator can produce voltages up to 1100V rms and must be programmed with caution to prevent hazardous voltages from being produced without sufficient warning to the operator.**

**Programs should be written carefully and tested extensively to ensure safe operation of the calibrator. We suggest that you include error-catching routines in your programs to ensure that your instrument performs as you intended. By setting the Service Request Enable register (SRE), described in paragraph 5-26, the calibrator can be programmed to cause an SRQ when an error is detected.**

**The following example shows a skeleton program that includes error-catching.**

```

10 PRINT @4, "CLS" !Clear status
20 PRINT @4, "*sre 8" !Set SRE Error Available bit
30 ON SRE GOTO 1000 !Enable controller SRQ function
100 !Put body of program here

900 STOP !Put body of program here

1000 REM start of SRQ Handler
1010 Print @4, "FAULT?" !Request fault code
1020 Input @4, A%
1030 Print @4, "EXPLAIN? ";A% !Get explanation of fault code
1040 Input @4, A$
1050 Print "Fault ";A$" detected" !Print message to programmer
1060 Print @4, "STBY" !Set 5700A to standby
1070 Stop

```

## 5-2. Using the IEEE-488 Port for Remote Control

The calibrator is fully programmable for use on the IEEE Standard 488.1 interface bus (IEEE-488 bus). The interface is also designed in compliance with supplemental standard IEEE-488.2. Devices connected to the bus in a system are designated as talkers, listeners, talker/listeners, or controllers. Under the remote control of an instrument controller, the calibrator operates exclusively as a talker/listener on the IEEE-488 bus.

This manual assumes you know the basics of the IEEE-488 interface bus. For an introduction to the bus, request Fluke Application Bulletin AB-36, "IEEE Standard 488-1978 Digital Interface for Programmable Instrumentation."

## 5-3. IEEE-488 Bus Restrictions

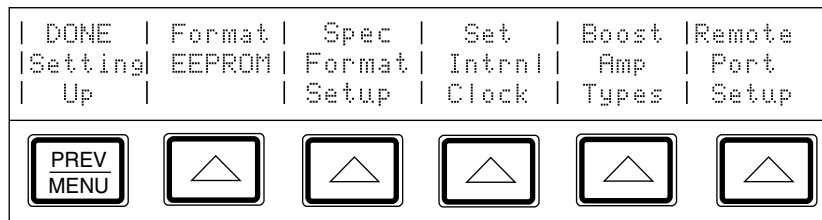
The following restrictions apply to all IEEE-488 systems:

1. A maximum of 15 devices can be connected in a single IEEE-488 bus system.
2. The maximum length of IEEE-488 cable used in one IEEE-488 system is either: 2 meters times the number of devices in the system, or 20 meters, whichever is less.

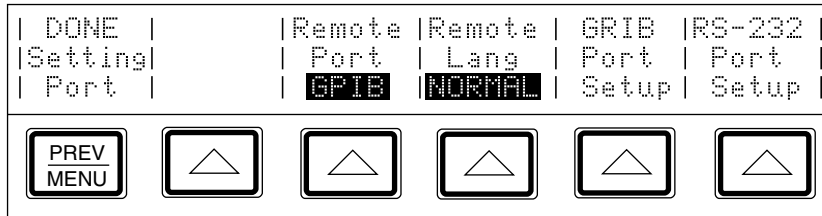
## 5-4. Bus Setup Procedure

Setting up the calibrator on the IEEE-488 bus requires only a choice of address and the connection to a controller. Once you have these items, proceed as follows to set up the calibrator for remote operation.

1. Turn the calibrator's power off
2. Attach the IEEE-488 cable to the rear panel IEEE-488 connector. Fluke shielded cables Y8021 (1m), Y8022 (2m), or Y8023 (4m), are recommended.
3. Turn the calibrator's power on.
4. Press the "Setup Menus" softkey.
5. Press the "Instmt Setup" softkey to open the Instrument Setup Menu, as shown:



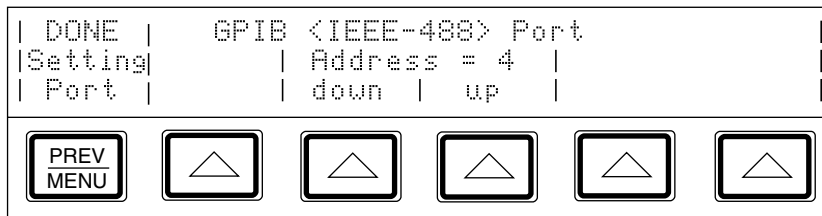
6. Press the “Remote Port Setup” softkey. The remote port setup menu appears:



7. Press the “Remote Port” softkey so that GPIB (General Purpose Interface Bus) appears. The GPIB port is the same as the IEEE-488 port.
8. Press the “Remote Lang” softkey until the correct mode appears. Select the mode according to the following options.
- Select NORMAL for all remote applications unless you are replacing a Fluke Model 5100B or 5200A with the 5700A/5720A Series II in an existing remote system.
  - If you are replacing a 5100B with the 5700A/5720A Series II, press the “Remote Lang” softkey until “5100” appears below the key label. This selects 5100B emulation mode which permits you to run 5100B commands on the 5700A/5720A Series II.
  - If you are replacing a 5200A with the 5700A/5720A Series II, press the “Remote Lang” softkey until “5200” appears. This selects 5200A emulation mode, which permits you to run 5200A commands on the 5700A/5720A Series II.

When in either 5100B or 5200A emulation mode, the 5700A/5720A Series II responds the commands specified for the instrument it is emulating; it does not respond to the commands described in this chapter. For more information about emulation mode, refer to “5100B Emulation Mode” or “5200A Emulation Mode” in this chapter.

9. If you wish to change the bus address from its factory default of 4, press the “GPIB Port Setup” softkey. The GPIB port setup menu appears:



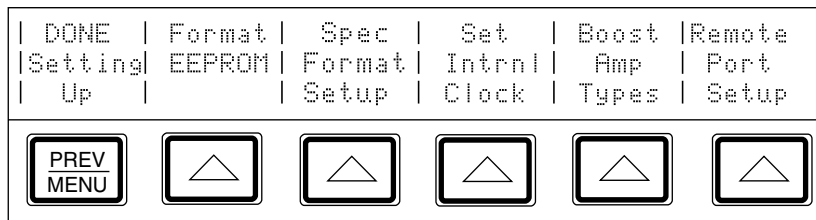
10. Change the address by pressing the “down” or “up” softkeys. Addresses are allowed in the range of 0 to 30. The address you select is saved in nonvolatile memory, and the IEEE-488 interface is changed to conform to the selection.

### 5-5. Using the RS-232C Port for Remote Control

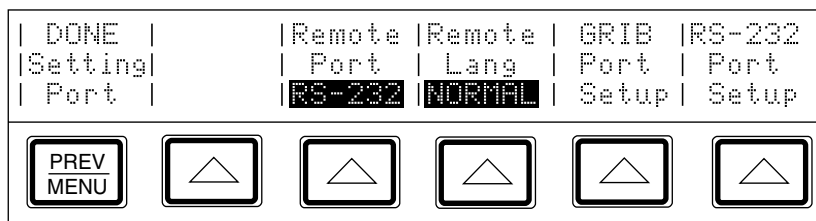
Skip these instructions if you are using an IEEE-488 controller such as the Fluke 1722A. This procedure is intended for those who are using the calibrator's serial interface for remote control from a terminal or computer with a serial interface.

**5-6. Serial Remote Control Setup Procedure.**

1. Turn the calibrator's power on.
2. Press the "Setup Menus" softkey.
3. Press the "Instmnt Setup" softkey. The Instrument Setup Menu appears:



4. Press the "Remote Port Setup" softkey. The remote port setup menu appears:



5. Press the "Remote Port" softkey. "RS-232" appears on the display.
6. Press the "Remote Lang" softkey. NORMAL appears on the display.
7. Press the "RS-232 Port Setup" softkey, set the RS-232C port to conform to the settings of the host device, and connect an interface cable as described in Chapter 6 under "Setting Up and Connecting the Serial Interface."

### **5-7. Exceptions for Serial Remote Control**

When using the RS-232C port to remotely control the calibrator, either interactively with a terminal or under computer control, operation is the same as using an IEEE-488 controller connected to the IEEE-488 port for control, with the following exceptions:

1. Control/C performs the same function as DCL (Device Clear) or SDC (Selected Device Clear).
2. The EOL (End of Line) input terminator is Carriage Return (Control/M) or Line Feed (Control/L). All output lines are terminated by the terminator programmed in a setup menu, or set using the remote command SP\_SET. This setting applies to all lines, including those with the \*PUD command (see number 4).
3. Control/R echoes to the port a Carriage Return, a Line Feed, and any uncompleted remote command entered. This allows you to see a copy of whatever has been typed in since the last command.
4. For the \*PUD (Protected User Data) Command, which stores characters for later recall, the serial remote interface does not store the following characters: Control/C, Line Feed (Control/J), Carriage Return (Control/M), Control/R, Control/S (XOFF), Control/Q (XON). These characters are processed as described above, so they cannot be a part of the \*PUD command. The \*PUD command terminates with Line Feed or Carriage Return, the same as all other serial remote commands.
5. There is no SRQ capability when using serial remote control. The status registers still behave as described in this section, but the calibrator's serial interface does not have a way to perform the SRQ function.
6. There are three special commands available only for serial remote control. These are described in Table 5-3.

### **5-8. Command Syntax Information**

The following syntax rules apply to all the remote commands. (A command consists of a word by itself or a word followed by one or more parameters.) The rules for parameter syntax are provided first (including proper usage of units and multipliers), followed by the rules for extra spaces, then followed by the rules for terminator usage. A description of how the calibrator processes incoming characters provides the basis for answering other possible questions about syntax. Information about syntax of response messages is also given.

### 5-9. Parameter Syntax Rules

Many of the remote commands require parameters, which must be used properly to avoid command errors. When a command error occurs, bit CME (5) in the Event Status Enable Register (ESE) goes to 1. General rules for parameter usage are:

1. When a command has more than one parameter, the parameters must be separated by commas. For example: "OUT 1 V, 100 HZ."
2. Numeric parameters may have up to 255 significant figures and their exponents may range from -32000 to +32000. The useful range for calibrator programming is  $\pm 2.2 \text{ E-308}$  to  $\pm 1.8 \text{ E308}$ .
3. Including too many parameters causes a command error.
4. Null parameters cause a command error (e.g., the adjacent commas in "CLOCK 133700, , 071787").
5. Expressions, for example "(4+2\*13)", are not allowed as parameters.

Units accepted in command parameters and used in responses are:

- HZ (frequency, hertz)
- MHZ (frequency, megahertz)
- V (voltage, volts)
- A (current, amperes)
- OHM (resistance, ohms)
- MOHM (resistance, megohms)
- DB (decibels)
- DBM (decibels referenced to 1 milliwatt for ac voltage amplitude)
- PCT (percent)
- PPM (parts per million)

Multipliers accepted in command parameters are:

- MA (mega, or unit x 1,000,000)
- K (kilo, or unit x 1,000)
- M (milli, or unit /1,000; except MOHM and MHZ)
- U (micro, or unit /1,000,000)

Some examples of allowed unit and multiplier combinations are:

- "MOHM" and "MAOHM" are both interpreted as megohms
- "MHZ" and "MAHZ" are both interpreted as megahertz
- "MV" is interpreted as millivolts
- "MAV" is interpreted as megavolts
- "MA" is interpreted as milliamperes

### 5-10. Extra Space Characters

Tables 5-2 and 5-3 and the remote program examples at the end of this chapter show commands and their parameters separated by spaces. One space after a command is required. All other spaces are optional. They are shown for clarity in the manual and may be left in or omitted as desired. Extra spaces can be inserted between parameters as desired. Extra spaces within a parameter are generally not allowed, except for between a number and its associated multiplier or unit.

<b>Example:</b>	<b>Explanation:</b>
“OUT 188.3 MA, 442 HZ”	Equivalent to “OUT 188.3MA,442HZ”
“OUT - 110.041 V”	Invalid; no space allowed in a number
“OUT -110.041 V”	Correct form for above

Table 5-2 contains examples for commands whose parameters are not self-explanatory. Remote program examples for the Fluke 1722A Instrument Controller are provided at the end of this section.

### 5-11. Terminators

To signify the end of a response sent to the controller, the calibrator sends a “terminator.” For response message terminators, the calibrator sends the ASCII character Line Feed with the EOI control line held high. The following characters are recognized by the calibrator as terminators when encountered in incoming data:

- ASCII LF character
- Any ASCII character sent with the EOI control line true

The terminator used by the Fluke 1722A Instrument Controller for data it sends to instruments on the IEEE-488 bus is programmable, but its default is LF with EOI.

### 5-12. Incoming Character Processing

The calibrator processes all incoming data as follows (except the 8-bit data byte portion of the \*PUD parameter):

1. An eighth bit (DIO8) is ignored.
2. All data is taken as 7-bit ASCII.
3. Lower-case or upper-case characters are accepted.
4. ASCII characters whose decimal equivalent is less than 32 (Space) are discarded, except for characters 10 (LF) and 13 (CR) and in the \*PUD command argument. \*PUD allows all characters in its argument and terminates in a special way.

### 5-13. Response Message Syntax

In Table 5-2, responses from the calibrator are described wherever appropriate. In order to know whether to read in an integer, a floating-point number, or character string, the first entry is (Integer), (Floating), or (String).

#### Note

*The responses described in the command tables are correct for IEEE-488 remote control, and for serial remote control in COMPUTER mode. TERMINAL mode (in serial remote control), responses contain more descriptive text intended for an operator using a terminal interactively.*

Integers for most controllers or computers are decimal numbers in the range -32768 to 32767. Response elements of this type are labeled as “integer” in the command tables. Floating-point numbers may be in exponential form, i.e. “1.15E-12”. String responses may be any ASCII printing characters. A special case of string response is in the CAL\_CLST?, CAL\_SHIFT?, CAL\_SLST?, CAL\_RPT?, ECHO?, EXPLAIN?, RPT\_STR?, \*OPT?, and \*STATE? commands. Those strings include leading and trailing quotation marks. (See Table 5-2 for details.)

### 5-14. Input Buffer Operation

As the calibrator receives each data byte from the controller, it places the bytes in a portion of memory called the input buffer. The input buffer holds up to 128 data bytes and operates in a first in, first out fashion.

The calibrator treats the EOI IEEE-488 control line as a separate data byte and inserts it into the input buffer if it is encountered as part of a message terminator.

Input buffer operation is transparent to the program running on the controller. If the controller sends commands faster than the calibrator can process them, the input buffer fills to capacity. When the input buffer is full, the calibrator holds off the IEEE-488 bus with the NFRD (Not Ready For Data) handshake line. When the calibrator has processed a data byte from the full input buffer, it then completes the handshake, allowing the controller to send another data byte.

The calibrator clears the input buffer on power-up and on receiving the DCL (Device Clear) or SDC (Selected Device Clear) messages from the controller.

Under RS-232C serial port remote control using Control/S (XOFF) protocol, the calibrator issues a Control/S (XOFF) when the input buffer becomes 80% full. The calibrator issues a Control/Q (XON) when it has read enough of the input buffer so that it is less than 40% full. When using RTS (Request to Send) protocol, the serial interface retracts and asserts RTS in response to same conditions as for XON/XOFF protocol.

### 5-15. Commands

Table 5-1 summarizes the commands by function. Table 5-2 provides protocol details of the remote commands. Table 5-3 provides protocol details of the three special commands available for serial remote control only. The commands duplicate almost all activities that can be initiated from the front panel in local operation. Separate headings for each command in the tables provide the parameters and responses (if any), and an example for cases in which the parameters are not self-explanatory.

### 5-16. Multiple Commands

Controllers using BASIC may send commands all at once, or one at a time, in BASIC PRINT statements. For example, if the calibrator's bus address is 3 and you want to set the calibrator to output 100 mV dc, some typical BASIC program statements would be:

```
10 REMOTE @3           ! PUT THE CALIBRATOR INTO THE REMOTE STATE
20 PRINT @3,"OUT 100 MV" ! SELECT 0.1V DC
30 PRINT @3,"OPER"     ! ACTIVATE THE OUTPUT LIKE THE OPR/STBY KEY
```

You can achieve the same results by combining the two commands in one statement as follows:

```
10 REMOTE @3
20 PRINT @3,"OUT 100 MV ; OPER"
```

In both versions of the program, the PRINT statements transmit all necessary interface messages (ATN and MLA) automatically.

### 5-17. Coupled Commands

When a compound command follows another command, there is a possibility that a fault can occur because of the action of the first command. Such commands are called coupled commands. An example of coupled commands that cause a fault is:

“OUT 1V, 1 MHZ”

followed by the compound command:

“OUT 100V” ; OUT 100 HZ.”

The second command causes a fault because when the calibrator encounters “OUT 100V”, it is interpreted as 100V, 1 MHz, which is out of range of the instrument. If only the second compound command was sent, there would have been no fault and the calibrator would be set to 100V at 100 Hz.

Another example is:

“OUT 1V ; RANGELCK ON”

followed by:

“OUT 10V ; RANGELCK OFF.”

In this case, when the calibrator interprets the first half of the second command, it causes an error since the previous command locked the range on 2.2V.

Any command that affects the state of the output is a coupled command, i.e. order-dependent. These commands include all the following: \*RST, BOOST, BTYPE, CAL\_CHK, CAL\_REF, CAL\_STORE, CAL\_ZERO, CUR\_POST, DIAG, EXTGUARD, EXTSENSE, FORMAT, INCR, LIMIT, MULT, NEWREF, OFFSET, OPER, OUT, PHASE, PHASELCK, PHASESFT, RANGELCK, RCOMP, REMOTE, LOCAL, LOCKOUT, SCALE, STBY, WBAND, CAL\_RNG. Be careful to use appropriate sequences when using these commands.

### **5-18. Sequential and Overlapped Commands**

Commands executed immediately as they are encountered in the data stream are called sequential commands. Commands that begin execution, but are completed some time later are called overlapped commands, because they can be overlapped by later commands. Headings under each command description in Tables 5-2 and 5-3 define whether the command is sequential or overlapped. Because the calibrator queues and executes overlapped commands in a multitasking way, \*OPC, \*OPC?, and \*WAI are useful to detect completion of overlapped commands. (See the full descriptions of \*OPC, \*OPC?, and \*WAI in Table 5-2 for more information.)

### **5-19. Commands Ignored When Not in Remote**

The calibrator can receive and execute most commands in either local or remote state. Commands that change the state of the instrument are prevented from executing unless the calibrator is in the remote state. At the end of each command description in Tables 5-2 and 5-3 it is noted if the command is ignored if the calibrator is not in the remote state. When the command description says, “ignored when not in remote,” it means that if sent to the calibrator in the local state, the command will not work, and logs a fault into the fault queue. (Or it returns the fault message if in serial remote terminal mode.)

To put the calibrator in remote, execute the 1722A BASIC command REMOTE or its equivalent for other controllers. If you are using the serial port for remote control, send the REMOTE command (described in Table 5-3) to the calibrator. Refer to “Remote/Local State Transitions” for more information.

### **5-20. Commands that Require the Calibration Switch to be Set**

The following commands do not work unless the rear panel CALIBRATION switch is in the ENABLE position: CLOCK, CAL\_STORE, CAL\_RNG STORE, CAL\_WBFLAT STORE, CAL\_WBGAIN STORE, \*PUD, and RPT\_STR. Attempting to use any of these commands with the CALIBRATION switch in the NORMAL position logs a fault into the fault queue. (Or it returns the fault message if in serial remote terminal mode.)

### **5-21. Long Term Commands**

Remote commands that take a relatively long time to execute are identified as such in Table 5-2, “Commands,” which follows the command summary in Table 5-1. If a command that produces a change in instrument state (i.e. any “I” command) is received during the execution of a long-term command, for example, CAL\_CHK, the command is ignored and a device-dependent fault occurs. (Bit 3 in the Event Status Register is set to 1 if enabled, and the fault code for the fault is available to be read from the fault queue. See the FAULT? and EXPLAIN? commands for more information.)

**Table 5-1. Command Summary by Function**

<b>Error Mode Commands</b>	
ADJOUT?	Returns the adjusted output magnitude and frequency
INCR	Increments or decrements the output
MULT	Multiplies the reference by a value and establishes a new reference
NEWREF	Establishes a new reference
OFFSET	Sets and enables or disables an offset
OFFSET?	Returns the value of the present offset
OLDREF	Sets the output to the present reference
OUT_ERR?	Returns the UUT error computed by the calibrator
REFOUT?	Returns the value of the present reference
SCALE	Activates and deactivates scaling
SCALE?	Returns scaling information
SCAL_ERR?	Returns the value of the scale error if scaling is active
<b>Instrument Configuration Commands</b>	
BTYPE	Selects the amplifier type for voltage or current boost
BTYPE?	Returns the amplifier types set for voltage and current boost
CLOCK	Sets the clock/calendar
CLOCK?	Returns the setting of the clock/calendar
CUR_POST	Selects the active binding post for current output
CUR_POST?	Returns the active binding post for current output
EXTGUARD	Opens and closes an internal connection between GUARD and LO
EXTSENSE	Opens and closes an internal connection between SENSE and OUTPUT
FORMAT	Restores calibration constants and setups to factory defaults
LIMIT	Sets positive and negative output limits
LIMIT?	Returns the programmed positive and negative output limits
*LRN?	Returns a list of commands that would duplicate the present state
RANGE?	Returns the present output range
RANGELCK	Locks in the present range, or selects autoranging

Table 5-1. Command Summary by Function (continued)

<b>Output Commands</b>	
BOOST	Activates or deactivates an auxiliary amplifier
DBMOUT?	Returns the output amplitude and frequency, but in dBm if ac V
OPER	Activates the calibrator's output if it is in standby
OUT	Sets the output and establishes a new reference for error mode
OUT?	Returns the output amplitude and frequency
PHASE	Sets the phase shift of the phase output signal
PHASE?	Returns the phase shift of the phase output signal
PHASELCK	Activates or deactivates phase locking to an external signal
PHASESFT	Activates or deactivates variable phase output
RCOMP	Activates or deactivates two-wire compensation circuitry
STBY	Puts the calibrator in standby
VOUT?	Returns the output amplitude in volts if the active units are dBm
WBAND	Activates or deactivates the Wideband AC Module (Option 5700A-03)
<b>Overall Functions</b>	
*CLS	Clear; clears status registers, any service request, and flags
ECHO?	Echoes a string to the remote port
GAL	Go to Alternate Language; enters Fluke 5100B emulation mode
*OPC	Sets bit 0 in the ESR to 1 when pending remote operations are complete
*OPC?	Returns a "1" when all pending remote operations are complete
*PUD	Stores a string of user-selected characters in nonvolatile memory
*PUD?	Returns the contents of the PUD memory
RPT_STR	Loads the user report string
RPT_STR?	Returns the user report string
*RST	Reset; sets the calibrator to its default power-up state
*WAI	Halts remote program execution until all pending remote operations are complete

**Table 5-1. Command Summary by Function (continued)**

<b>RS-232-C Interface Parameter Setting Commands</b>	
SP_EOF	Sets the End-Of-File (EOF) string
SP_EOF?	Returns the End-Of-File (EOF) string
SP_SET	Sets baud, terminal or computer mode, stall method, data bits, stop bits, parity, and End-Of-Line (EOL) string
SP_SET?	Returns baud rate, terminal or computer mode, stall method, data bits, stop bits, parity, and End-Of-Line (EOL) string
SP_TIME	Sets the timeout period
SP_TIME?	Returns the timeout period
<b>Calibration, Testing, and Diagnostics Commands for the Calibrator</b>	
CAL_ADJ	Does the internal portion of calibration
CAL_CHK	Starts calibration check
CAL_CLST?	Returns a group of calibration constant names and their values
CAL_CONF	Sets the calibration specifications to a confidence level of either 95% or 99%.
CAL_CONF?	Returns the current calibration confidence level.
CAL_CONST?	Returns the value of a particular constant
CAL_DATE?	Returns the date of the most recent calibration
CAL_DAYS?	Returns the days elapsed since last calibration recall
CAL_INTV	Sets the calibration interval
CAL_INTV?	Returns the calibration interval
CAL_PR	Prints a calibration report out the serial interface
CAL_REF	Does a calibration procedure using a 1 $\Omega$ , 10 k $\Omega$ , or 10V standard
CAL_RNG	Starts a self calibration procedure of a range
CAL_RPT?	Returns a formatted calibration report
CAL_SHIFT?	Returns the shift of a range due to a calibration action
CAL_SLST?	Returns the shifts of a group of ranges
CAL_STORE	Stores new calibration constants in nonvolatile memory
CAL_TEMP	Sets the temperature for calibration
CAL_TEMP?	Returns the calibration temperature last specified
CAL_WBFLAT	Does Wideband AC Module (Option 5700A-03) flatness calibration
CAL_WBGAIN	Does Wideband AC Module (Option 5700A-03) gain calibration
CAL_ZERO	Does internal zeros calibration
DIAG	Runs self diagnostics

**Table 5-1. Command Summary by Function (continued)**

<b>Calibration, Testing, and Diagnostics Commands for the Calibrator (continued)</b>	
DIAGFLT	Sets the calibrator's response to faults in remote diagnostics
DIAGFLT?	Returns the calibrator's response to faults in remote diagnostics
OHMSREF?	Returned calculated resistance reference (Main software revision H and after)
STOP_PR	Stops printing a report
*TST?	Performs a series of self tests and returns the results
<b>Serial Only Remote Commands</b>	
LOCAL	Puts the calibrator into the local state
LOCKOUT	Puts the calibrator into the local lockout state
REMOTE	Puts the calibrator into remote state
<b>Status Commands</b>	
*ESE	Loads the Event Status Enable register
*ESE?	Reads the Event Status Enable register
*ESR?	Reads and clears the Event Status Register
ETIME?	Elapsed time query. Returns the cumulative number of minutes powered on.
EXPLAIN	Decodes a fault code by returning a brief description
FAULT?	Returns the most recent fault code from the fault queue
*IDN?	Returns calibrator identification information
ISCE	Loads the Instrument Status Change Enable register
ISCE?	Reads the Instrument Status Change Enable register
ISCR?	Reads and clears the Instrument Status Change Register
ISR?	Reads and clears the Instrument Status Register
ONTIME?	Returns the number of minutes since power-up this session
*OPT?	Returns a list of installed modules and attached amplifiers
*SRE	Loads the Service Request Enable register
*SRE?	Reads the Service Request Enable register
STATE?	Returns the long-term state of the calibrator
*STB?	Returns the status byte
UNCERT?	Returns the calculated absolute uncertainty of the output

**Table 5-2. Commands**

<b>ADJOUT?</b>	
Description	Sequential Command.  Returns the adjusted output magnitude and frequency. The adjusted output magnitude is the output after modification by the front panel knob or the INCR remote command. In all output functions but resistance, ADJOUT? behaves exactly like OUT?. In the resistance function, OUT? returns the actual calibrator's output, which cannot be adjusted, and ADJOUT? returns what would be the reading on the Control Display in direct operation. The frequency is always the present output frequency.
Parameter	None
Response	1. (Float) Output amplitude 2. (String) Units (V, DBM, A, or OHM) 3. (Float) Frequency (0 if dc or ohms)
Examples	1.256983E+01,V,0 (12.56983V) 1.883E-01,A,4.42E+02 (188.3 mA, 442 Hz) 1.9E+06,OHM,0 (1.9 MΩ)
<b>BOOST</b>	
Description	Overlapped Command, ignored if not in remote. Activates and deactivates an accessory amplifier.
Parameter	ON Activates the appropriate amplifier for the type of output) OFF Deactivates the active amplifier
Example	BOOST ON  Activates the appropriate amplifier if the last OUT command selected an output supported by the attached amplifier.
<b>BTYPE</b>	
Description	Sequential command, ignored if not in remote.  Selects the accessory amplifiers for current and voltage boost. If the BOOST command is active when BTYPE is received, BTYPE does not take effect until the next time the BOOST command is received. The setting of BTYPE remains even after the power is turned off.
Parameter	One of the following: VB5725 (Selects the 5725A for voltage boost) IB5725 (Selects the 5725A for current boost)
Example:	BTYPE IB5725  Selects Model 5725A as the current amplifier.

Table 5-2. Commands (continued)

<b>BTYPE?</b>	
Description	Sequential command. Returns the model numbers of auxiliary amplifiers selected for voltage and current boost.
Parameter	None
Response	(String, string) VB<model number>,IB<model number>
Example:	BTYPE?  Returns: "VB5725,IB5725" if Model 5725A is selected for voltage boost and Model 5725A is selected for current boost.
<b>CAL_ADJ</b>	
Description	Overlapped long-term command, ignored if not in remote. Performs the internal calibration. This command should be sent after the last CAL_REF command in the sequence of calibration. (See CAL_REF for an example.)
Parameter	None
<b>CAL_CHK</b>	
Description	Overlapped long-term command, ignored if not in remote. Starts calibration check. Results are available via the CAL_SLST? or CAL_SHIFT? commands.
Parameter	None
<b>CAL_CLST?</b>	
Description	Sequential command. Returns a list of names values of a particular group of calibration constants.
Parameter	CAL (Returns active calibration constants) CHECK (Returns calibration check constants) PREV (Returns previous calibration constants)
Response	(String) "<EOL> <total number of constants> <EOL> <name> <value> <EOL> <name> <value> <EOL> (cont) "
Example:	CAL_CLST? Could return: " 424 D3P, 3.9817876E+02 (Continues for about 400 pairs of names and values.) "

**Table 5-2. Commands (continued)**

<b>CAL_CONF</b>	
Description	Sequential command. Sets the calibration specifications to a confidence level of either 99% or 95%.
Parameters:	CONF95 or CONF99: Sets 95% or 99% specifications.
<b>CAL_CONF?</b>	
Description	Sequential command. Returns the current calibration confidence level.
Parameters:	None
Response	CONF95 (indicates 95% specifications)a or CONF99 (indicates 99% specifications)
<b>CAL_CONST?</b>	
Description	Sequential command. Returns the value of a particular calibration constant from a particular group of constants.
Parameters:	1. CAL (From active calibration constants) CHECK (From calibration check constants) PREV (From previous calibration constants) 2. Symbolic name of the calibration constant desired (see Appendix D).
Response	(Float) The value of the constant
Example:	CAL_CONST? CHECK, KV6 Could return: 6.5000010E+00
<b>CAL_DATE?</b>	
Description	Sequential command. Returns the date of the most recent calibration of the specified type.
Parameter	B5725 (Last 5725A Amplifier calibration) CAL (Last calibration of the calibrator) WBFLAT (Last wideband flatness calibration) WBGAIN (Last wideband gain calibration) ZERO (Last dc V zero calibration)
Response	(Integer) Date as MMDDYY, DDMMYY, or YYMMDD depending on the setting of DATEFMT.
<b>CAL_DAYS?</b>	
Description	Sequential command. Returns the number of days elapsed since the last calibration activity of the specified type.
Parameter	B5725 (Last 5725A Amplifier calibration) CAL (Last calibration of the calibrator) WBFLAT (Last wideband flatness calibration) WBGAIN (Last wideband gain calibration) ZERO (Last dc V zero calibration)
Response	(Integer) Number of elapsed days

Table 5-2. Commands (continued)

<b>CAL_INTV</b>	
Description	Sequential command, ignored if not in remote.  Sets the calibration interval for main output calibration. This value is saved in nonvolatile memory and used for calculating the calibrator's output uncertainty.
Parameter	1, 90, 180, or 365; the number of days in the calibration cycle.
<b>CAL_INTV?</b>	
Description	Sequential command.  Returns the calibration interval for main output calibration.
Parameter	None
Response	(Integer) 1, 90, 180, or 365; the number of days in the calibration cycle.
<b>CAL_PR</b>	
Description	Overlapped command.  Sends a calibration report printout for a particular calibration activity through the RS-232-C serial interface. This is for IEEE-488 remote control only. (See Chapter 6 for printout format details.)
Parameter	CAL (Output change report for calibration) CHECK (Output change report for cal check) RAW (A list of all calibration constants)
<b>CAL_REF</b>	
Description	Overlapped long-term command, ignored if not in remote.  Calibrates the internal references for the main output functions based on comparison to an externally-applied standard. To calibrate the 5700A/5720A Series II calibrator, the controller must send a CAL_TEMP command, a sequence of CAL_REF commands (one for each external standard), followed by a CAL_ADJ command, then a CAL_STORE command. These commands must be in the same sequence as in the example. Note that the CALIBRATION switch must be set to ENABLE for the CAL_STORE command. To only collect performance data, use this command without a CAL_STORE.
Parameter	The true value of the external standard attached to the calibrator's binding posts. The value and units of the parameter tell the calibrator which calibration procedure to perform.
Example:	CAL_TEMP 23.5 CAL_REF 10.00013 V ; *WAI CAL_REF -10.00013 V ; *WAI CAL_REF 9.99987 KOHM ; *WAI CAL_REF 1.00026 OHM ; WAI CAL_ADJ CAL_STORE ; *WAI

**Table 5-2. Commands (continued)**

<b>CAL_RNG</b>	
Description	Overlapped command, ignored if not in remote.  Starts a calibration of a range. This command causes the calibrator to source the calibration magnitude specified by the second parameter for the range specified by the first parameter. To calibrate a range, the controller must send commands in the same sequence as in the example.
Parameters:	<ol style="list-style-type: none"> <li>1. The range identifier of the range to calibrate from Table 5-4, or the keyword NULL or STORE.</li> <li>2. (Only if parameter 1 is the range mnemonic) The calibration magnitude for the calibrator to source. Must be 45% to 95% of the range specified.</li> <li>3. (Optional; only if parameter 1 is the range mnemonic) The frequency of the calibrator output with optional multiplier and units.</li> </ol>
Example:	<pre> CAL_TEMP 23.5 CAL_RNG DC2_2V, 2V ; OPER ; *WAI INCR (enough to null the calibrator) CAL_RNG NULL CAL_RNG STORE           </pre>
<b>CAL_RPT?</b>	
Description	Sequential command. Returns a report for a specified calibration activity (see Chapter 6 for format details).
Parameter	CAL (Output change report for calibration) CHECK (Output change report for cal check) RAW (A list of all calibration constants)
Response	(String) "<EOL> <formatted report> "
Example:	<pre> 10 REM THIS 1722A PROGRAM SAVES FORMATTED REPORT IN A FILE 20 CLOSE 1 \ OPEN "MF0:CALRPT" AS NEW FILE #1 30 PRINT @4,'CAL_RPT? CAL' 40 INPUTLINE @4,A\$ ! THROW AWAY BEGINNING QUOTE 50 ! DO { 60 INPUTLINE @4,A\$ 70 PRINT #1,A\$ 80 IF LEFT(A\$,1%) != "" GOTO 60 90 !} WHILE(NOT END OF FILE           </pre>

Table 5-2. Commands (continued)

CAL_SHIFT?	
Description	Sequential command. Returns a particular set of output shifts from a particular range.
Parameters:	1. CAL (Output changes due to calibration check) CHECK (All output changes due to calibration check) 2. Range identifier from Table 5-4
Response	(String) "<EOL> range name>,<# points><EOL> <mag 1>,<freq 1>,<offset 1>,<ashift 1>,<rshift 1><sshift 1>,<spec 1><EOL> ... <mag n>,<freq n>,<offset n>,<ashift n>,<rshift 1>,<sshift n>,<spec n><EOL> " Where: <range name> = Range identifier from Table 5-4 <# points> = (Integer) Number of points for the range <mag n> = (Float) Magnitude for point n in range units <freq n> = (Float) Frequency for point n in Hz <offset n> = (Float) Zero shift for point n in range units <ashift n> = (Float) Absolute shift for point n in range units <rshift n> = (Float) Relative shift for point n (ppm) <sshift n> = (Float) % of spec shift for point n <spec n> = calibrator specification for point n in ppm Range units are the appropriate units for the range, e.g., for all DC V ranges, range units are V.
Example:	CAL_SHIFT? CAL, DC220MV could return: " DC220MV,2 2.20E-1,0.00E+00,1.76E-07,1.97E-07,8.98E-01,7.10E+00,1.26E+01 -2.20E-1,0.00E+00,1.58E-07,1.38E-07,6.26E-01,4.95E+00,1.26E+01 "

**Table 5-2. Commands (continued)**

<b>CAL_SLST?</b>	
Description	Sequential command. Returns a group of calibration constant shifts due to a calibration activity.
Parameter	CAL (All output changes due to calibration) CHECK (All output changes due to calibration check)
Response	(String) "<EOL>  <range name>,<# points><EOL> <mag 1>,<freq 1>,<offset 1>,<ashift 1>,<rshift 1>,<sshift 1>,<spec 1><EOL> ... <mag n>,<freq n>,<offset n>,<ashift n>,<rshift 1>,<sshift n>,<spec n><EOL> "  Where:  <div style="margin-left: 40px;">                     &lt;range name&gt; = Range identifier from Table 5-4                      &lt;# points&gt; = (Integer) Number of points for the range                      &lt;mag n&gt; = (Float) Magnitude for point n in range units                      &lt;freq n&gt; = (Float) Frequency for point n in Hz                      &lt;offset n&gt; = (Float) Zero shift for point n in range units                      &lt;ashift n&gt; = (Float) Absolute shift for point n in range units                      &lt;rshift n&gt; = (Float) Relative shift for point n (ppm)                      &lt;sshift n&gt; = (Float) % of spec shift for point n                      &lt;spec n&gt; = calibrator specification for point n in ppm                 </div> Range units are the appropriate units for the range, e.g., for all DC V ranges, range units are V.
Example:	CAL_SLST? CAL could return: " 49 DC220MV,2 2.20E-1,0.00E+00,1.76E-07,1.97E-07,8.98E-01,7.10E+00,1.26E+01 -2.20E-1,0.00E+00,1.58E-07,1.38E-07,6.26E-01,4.95E+00,1.26E+01 DC2_2V,2 (cont) "
<b>CAL_STORE</b>	
Description	Sequential command, ignored if not in remote. Stores all new calibration constants in nonvolatile memory. Use this command to save the results of a CAL_ADJ command after you are completely finished with calibration via remote control. The rear panel CALIBRATION switch must be in the ENABLE position or an execution fault results.
Parameter	None

Table 5-2. Commands (continued)

<b>CAL_TEMP</b>	
Description	Sequential command, ignored if not in remote.  Sets the temperature for calibration. This should be done before sending CAL_REF, CAL_WBFLAT, CAL_WBGAIN, or CAL_CHK commands. Once set, the temperature is used for all calibration activities until it is changed. If the temperature is not set before a calibration activity, the calibrator uses a default of 23.0°C.
Parameter	Temperature in degrees C.
<b>CAL_TEMP?</b>	
Description	Sequential command.  Returns the previous ambient temperature setting used for a particular calibration procedure.
Parameter	B5725, CAL, WBFLAT, WBGAIN, or CHECK
Response	(Float) Temperature in degrees C.
<b>CAL_WBFLAT</b>	
Description	Overlapped command, ignored if not in remote.  Does Wideband AC Module (Option 5700-03) flatness calibration. There are two different calibration procedures for the wideband module; gain and flatness. Wideband gain is to be done at every calibration cycle. Wideband flatness is needed only during full verification, recommended every two years. For reference, the manual procedure for wideband flatness cal is in Chapter 3 of the <i>5700A/5720A Series II Service Manual</i> .  After sending a CAL_WBFLAT START command, the controller must adjust the calibrator's output using the INCR command until it matches the calibration voltage, then inform the calibrator of the fact by sending a CAL_WBFLAT NULL command. A series of points to test is selected automatically by the software. After each CAL_WBFLAT NULL command, you can determine the calibration setting by sending an OUT? command.
Parameter	START (Starts flatness calibration, sources the first point) NULL (Calculates flatness constant, sources the next point) STORE (Stores wideband flatness constants into EEPROM)
Example:	CAL_TEMP 24.6 CAL_WBFLAT START (Connect to external standard as in the Service Manual) OPER INCR (Enough to get the calibrator's output correct) CAL_WBFLAT NULL (Repeat the preceding two commands for each calibration point. CAL_NULL automatically sources the next calibration point. When OUT? returns 0,V,0, all points have been calibrated.) CAL_WBFLAT STORE

**Table 5-2. Commands (continued)**

<b>CAL_WBGAIN</b>	
Description	Overlapped long-term command, ignored if not in remote.  Does Wideband AC Module (Option 5700-03) gain calibration. There are two different calibration procedures for the wideband module: gain and flatness. Wideband gain is to be done at every calibration cycle. Wideband flatness is needed only during full verification (recommended every two years). For reference, the manual procedure for wideband gain cal is in Chapter 7.  To calibrate wideband gain in remote, the wideband output cable must be connected to the calibrator's SENSE binding posts as described in Chapter 7, then the controller must send commands in the same sequence as in the example. For positive gain, the center conductor is connected to SENSE HI. For negative gain, the center conductor is connected to SENSE LO.
Parameter	PGAIN (Calibrates wideband positive gain) NGAIN (Calibrates wideband negative gain) STORE (Stores wideband constants into EEPROM)
Example:	CAL_TEMP 23.5 CAL_WBGAIN PGAIN (Calibrates positive gain) (Reverse the SENSE connection now) CAL_WBGAIN NGAIN (Calibrates negative gain) CAL_WBGAIN STORE
<b>CAL_ZERO</b>	
Description	Overlapped long-term command, ignored if not in remote.  Performs internal zeros calibration. This removes offsets on the 2.2V dc range. It takes about 2-1/2 minutes, plus 30 seconds if teamed with 5725A, and does not require setting the CALIBRATION switch.
Parameter	None
<b>CLOCK</b>	
Description	Sequential command, ignored if not in remote.  Sets the clock/calendar. The rear panel CALIBRATION switch must be in the ENABLE position or an execution fault results.
Parameters:	1. Time in 24-hour format as HHMMSS 2. Date as MMDDYY, DDMMYY, or YYMMDD depending on the setting the DATEFMT.
Examples	CLOCK 133700, 071788 (Sets the clock/calendar to 1:37 p.m., July 17, 1988.) CLOCK 080000, 101088 (Sets the clock/calendar to 8:00 a.m., November 10, 1988.)
<b>CLOCK?</b>	
Description	Sequential command.  Returns the setting of the clock/calendar.
Parameter	None
Response	1. (Integer) Time in 24-hour format as HHMMSS. 2. (Integer) Date as MMDDYY, DDMMYY, or YYMMDD depending on the setting of DATEFMT.
Example:	CLOCK? Returns: "150000,090188" if the clock/calendar is set to 3 p.m., September 1, 1988.

Table 5-2. Commands (continued)

<b>*CLS</b>	
Description	Sequential command. (Clear status.) Clears the ESR, ISCR, the fault queue, and the RQS bit in the status byte. This command terminates pending operation complete commands (*OPC or *OPC?).
Parameter	None
<b>CUR_POST</b>	
Description	Sequential command, ignored if not in remote. Selects the binding posts for current output. Once set, the calibrator retains the current post setting during power-off periods.
Parameter	NORMAL (Selects the OUTPUT HI binding post) AUX (Selects the AUX CURRENT OUTPUT binding post) IB5725 (Selects binding posts on the 5725A)
<b>CUR_POST?</b>	
Description	Sequential command. Returns the binding posts for current output.
Parameter	None
Response	(String) NORMAL (The OUTPUT HI binding post is selected) AUX (The AUX CURRENT OUTPUT binding post is selected) IB5725 (The 5725A binding posts are selected)
<b>DATEFMT</b>	
Description	Determine the format for clock/calendar front panel date display and entry, for entering and reading the date remotely using the CLOCK and CLOCK? commands, and for displaying calibration dates on the front panel and in calibration reports.
Parameter	MDY (Display: MM/DD/YY, remote and front panel entry: MMDDYY) DMY (Display: DD.MM.YY, remote and front panel entry: DDMMYY) YMD (Display: YYMMDD, remote and front panel entry: YYMMDD)
<b>DATEFMT?</b>	
Description	Returns the date format setting (see DATEFMT for its applications).
Parameter	None
Response	(String) MDY (Display: MM/DD/YY, date entry: MMDDYY), DMY (Display: DD.MM.YY, date entry: DDMMYY), or YMD (Display: YYMMDD, date entry: YYMMDD)
<b>DBMOUT?</b>	
Description	Sequential command. Same as OUT? except that if output is ac V, the returned magnitude is converted to dBm for the appropriate load (50Ω for wideband, 600Ω standard ac V).
Parameter	None
Response	1. (Float) Output value 2. (String) Units (DBM, V, A, or OHM) 3. (Float) Frequency (0 if dc or ohms)
Examples	1.256983E+01,V,0 (12.56983V) 28.345,DBM,442 1.9E+06,OHM,0 (1.9 MΩ)

**Table 5-2. Commands (continued)**

<b>DIAG</b>	
Description	Overlapped long-term command, ignored if not in remote.  Runs a self-diagnostics routine. If any faults are detected, they are logged into the fault queue where they can be read by the FAULT? query. The response to faults that occur during remote-controlled diagnostics depends by the setting of the DIAGFLT command.
Parameter	ALL (Runs all diagnostics routines) D5700 (Runs all calibrator diagnostics) DV5725 (Runs 5725A voltage diagnostics) DI5725 (Runs 5725A current diagnostics) CONT (Continues execution of diagnostics) ABORT (Terminates execution of diagnostics)
<b>DIAGFLT</b>	
Description	Sequential command, ignored if not in remote.  Determines the response to faults that occur during remote-controlled diagnostics. In all cases the fault encountered is logged into the fault queue before the calibrator takes any action as set by this command. The settings of this command are saved in nonvolatile memory. The default is ABORT.
Parameter	HALT (Halts and waits for DIAG CONT or DIAG ABORT) ABORT (Terminates diagnostics) CONT (Diagnostics continues to completion, logging any more faults as encountered)
<b>DIAGFLT?</b>	
Description	Sequential command.  Returns the setting of DIAGFLT.
Parameter	None
Response	(String) HALT, ABORT, or CONT
<b>ECHO?</b>	
Description	Sequential command.  Echoes a string back to the remote interface port. Upper or lower case remains intact in this command.
Parameter	Any string
Response	(String including delimiting quotation marks)
Example:	ECHO "123abc456" Returns: "123abc456"
<b>*ESE</b>	
Description	Sequential command.  Loads a byte into the Event Status Enable Register, described under "Checking the Calibrator's Status."
Parameter	The decimal equivalent of the binary number to load into the register (0-255 only).
Example:	*ESE 140  Enables bits 2 (QYE), 3 (DDE), and 7 (PON), and disables all the other bits. (See "Checking the Calibrator's Status" for details.)

Table 5-2. Commands (continued)

<b>*ESE?</b>	
Description	Sequential command. Returns the byte from the Event Status Enable register, described under "Checking the Calibrator's Status."
Parameter	None
Response	(Integer) Decimal equivalent of the register byte.
Example:	*ESE? Returns: "140" if bits 2 (QYE), 3 (DDE), and 7 (PON) are enabled (1) and the rest of the bits are disabled (0). (See "Checking the Calibrator's Status" for details.)
<b>*ESR?</b>	
Description	Sequential command. Returns the byte from the Event Status Register and clears the register. The ESR is described under "Checking the Calibrator's Status."
Parameter	None
Response	(Integer) Decimal equivalent of the register byte.
Example:	*ESR? Returns: "140" if bits 2 (QYE), 3 (DDE), and 7 (PON) are set (1) and the rest of the bits are reset (0). (See "Checking the Calibrator's Status" for details.)
<b>ETIME?</b>	
Description	Sequential command. Elapsed time query. The response is the total number of minutes that the power switch has been on for the life of the instrument. An example of using this command would be detecting when an interval you set for cleaning the air filter has expired.
Parameter	None
Response	(Integer) Total number of minutes that the power has been on.
<b>EXPLAIN?</b>	
Description	Sequential command. Explains a fault code. This command returns a string that explains the fault code furnished as the parameter. The fault code (same as the parameter) is originally obtained by sending the FAULT? query.
Parameter	The fault code (an integer).
Response	(String) An explanation of the fault code.
Example:	EXPLAIN? 725 Returns: ILLEGAL LIMIT SETTING

**Table 5-2. Commands (continued)**

<b>EXTGUARD</b>	
Description	Overlapped command, ignored if not in remote.  Sets the calibrator to internal or external guard. (The same as pressing EX GRD in local operation.) The default is internal guard.
Parameter	ON      (Sets the calibrator to external guard) OFF     (Sets the calibrator to internal guard)
<b>EXTSENSE</b>	
Description	Overlapped command, ignored if not in remote.  Selects internal or external sensing. (The same as pressing EX SNS in local operation.) The default if internal sensing.
Parameter	ON      (Sets the calibrator to external sensing) OFF     (Sets the calibrator to internal sensing)
<b>FAULT?</b>	
Description	Sequential command.  Returns the earliest fault code contained in the calibrator's fault queue. After you get the fault code, you can use the EXPLAIN? command to find out the meaning of the fault code. A table of fault codes is also included in Chapter 4 of this manual.  A zero value is returned if there are no faults, so to read the entire contents of the fault queue, repeat FAULT? until the response is "0."
Parameter	None
Response	(Integer) The fault code
<b>FORMAT</b>	
Description	Sequential command, ignored if not in remote.  Use with extreme care. Restores the contents of the EEPROM (Electrically-Erasable Programmable Read Only Memory) to factory defaults. The EEPROM holds calibration constants and setup parameters. You lose all calibration data permanently. The CALIBRATION switch must be in the ENABLE position, or an execution fault occurs.
Parameter	ALL      (Replaces the whole contents with defaults) B5725    (Replaces 5725A cal constants with defaults) CAL      (Replaces all cal constants with defaults) RNG      (Replaces range cal constants with defaults) SETUP    (Replaces setup parameters with defaults)
<b>GAL</b>	
Description	Sequential command.  (Go to Alternate Language.) Selects the 5100B emulation remote mode. The new language remains selected even after the power is turned off. The inverse command in 5100B mode, to go back to normal mode, is a tilde (~).
Parameter	L5100 5100B emulation remote mode

Table 5-2. Commands (continued)

<b>*IDN?</b>	
Description	Sequential command. Returns instrument model number and firmware version letters for the main, inguard, and if attached, the 5725A Amplifier CPU.
Parameter	None
Response	(String, string, 0, string) A message containing four fields separated by commas, as follows: 1. Fluke 2. Model number (5700A or 5720A) 3. Serial number 4. Three firmware versions: one each for the Main CPU, the Inguard CPU, and the Boost CPU. Each version is separated by a plus (+). If no amplifier is attached then its position (third character) contains an asterisk (*).
Example:	FLUKE,5720A,5248000,1.0+B+*
<b>INCR</b>	
Description	Overlapped command, ignored if not in remote. Increments the output amplitude and enters error mode, the same as using the output adjustment knob in local operation.
Parameter	Increment step size; positive for incremental step, negative for decremental step. Units (optional) specify magnitude or frequency.
Examples	INCR -.00001          Enters error mode and decrements the output by .00001. INCR 1 Hz              Enters error mode and increments the frequency by 1 Hz.
<b>ISCE</b>	
Description	Sequential command. Loads a byte into the Instrument Status Change Enable register described under "Checking the Calibrator's Status."
Parameter	The decimal equivalent of the binary number to load into the register.
Example:	ISCE 56 Enables bits 3 (BOOST), 4 (RCOMP), and 5 (RLOCK) in the Service Request Enable register.
<b>ISCE?</b>	
Description	Sequential command. Returns the byte from the Instrument Status Change Enable register, described under "Checking the Calibrator's Status."
Parameter	None
Response	The decimal equivalent of the register contents byte.
Example:	ISCE? Returns: "4" if bit 3 (BOOST) is enabled (1) and the rest of the bits are disabled (0). (See "Checking the Calibrator's Status" for details.)

**Table 5-2. Commands (continued)**

<b>ISCR?</b>	
Description	Sequential command. Returns and clears the byte from the Instrument Status Change Register, described under "Checking the Calibrator's Status."
Parameter	None
Response	The decimal equivalent of the register contents byte.
Example:	ISCR? Returns: "8" if bit 3 (BOOST) is set (1) and the rest of the bits are reset (0). (See "Checking the Calibrator's Status" for details.)
<b>ISR?</b>	
Description	Sequential command. Returns and clears the byte from the Instrument Status Register, described under "Checking the Calibrator's Status."
Parameter	None
Response	The decimal equivalent of the register contents byte.
Example:	ISR? Returns: "16" if bit 4 (RLOCK) is set (1) and the rest of the bits are reset (0). (See "Checking the Calibrator's Status" for details.)
<b>LIMIT</b>	
Description	Sequential command, ignored if not in remote. Sets the maximum permissible output magnitudes, negative and positive. Both parameters must be present, and the units must be none, volts, or amps. The units must not conflict. If no units are specified, V is assumed.
Parameter	1. Positive limit value with optional multiplier and optional unit. 2. Negative limit value with optional multiplier and optional unit.
Example:	LIMIT 1.8A, -1.2A Sets the limit for ac and positive dc current to 1.8A, and negative dc current to -1.2A.
<b>LIMIT?</b>	
Description	Sequential command. Returns the programmed output magnitude limits for voltage and current.
Response	(Float, float, float, float) 1. Positive voltage limit value 2. Negative voltage limit value 3. Positive current limit value 4. Negative current limit value
Example:	LIMIT? Returns: "2.20E-2,-1.0E-2,1.8E0,-1.2E0" if the programmed voltage range is -100 to 220V, and the programmed current range is -1.2 to 1.8A.

Table 5-2. Commands (continued)

<b>*LRN?</b>																
Description	Sequential command. Provides the current setting of the calibrator. The response to this command is a string that recreates the state of the following settings when returned to the calibrator: <table border="0" style="width: 100%; border-collapse: collapse;"> <tr> <td style="width: 33%;">Output value</td> <td style="width: 33%;">Whether the wideband AC Module is on</td> <td style="width: 33%;">Phase lock</td> </tr> <tr> <td>Operate/standby</td> <td>Whether an auxiliary amplifier is on</td> <td>Phase shift</td> </tr> <tr> <td>Guard</td> <td>Range lock</td> <td>Offset</td> </tr> <tr> <td>Sense</td> <td>Two-wire compensation</td> <td>Scale</td> </tr> <tr> <td>Output limits</td> <td></td> <td></td> </tr> </table>	Output value	Whether the wideband AC Module is on	Phase lock	Operate/standby	Whether an auxiliary amplifier is on	Phase shift	Guard	Range lock	Offset	Sense	Two-wire compensation	Scale	Output limits		
Output value	Whether the wideband AC Module is on	Phase lock														
Operate/standby	Whether an auxiliary amplifier is on	Phase shift														
Guard	Range lock	Offset														
Sense	Two-wire compensation	Scale														
Output limits																
Parameter	None															
Response	(String) A string that enables the settings that were set at the time of the *LRN? command.															
Example:	PRINT @4, "*LRN?" INPUTLINE @4, A\$ . . (Later, to recreate the settings:) PRINT @4, A\$															
<b>MULT</b>																
Description	Overlapped command, ignored if not in remote. Multiplies the reference magnitude by the parameter and changes the output to the new value. The reference magnitude is the present output in direct operation, and the reference in error mode.															
Parameter	Floating-point number to act as a multiplier															
Example:	If the output is 10V with error mode off and you send the command, "MULT 1.9", the output changes to 19V.															
<b>NEWREF</b>																
Description	Sequential command, ignored if not in remote. Sets reference value to be the present output value. (The same as pressing the NEW REF key in local operation.)															
Parameter	None															
<b>OFFSET</b>																
Description	Sequential command, ignored if not in remote. Enables and disables an offset for the output value. Effective immediately when enabled.															
Parameters:	ON or OFF															
<b>OFFSET?</b>																
Description	Sequential command. Returns the offset value if the offset is enabled; otherwise, returns the number 0.0.															
Parameter	None															
Response	1. (Float) Offset value or 0.0 if no offset is active 2. (Float) Offset units															
Example:	OFFSET? Returns: "5.05000E-03,V" if an offset of 5.05 mV is active.															

**Table 5-2. Commands (continued)**

<b>OHMREF?</b>	
Description	Return calculated resistance reference as shown in calibration report (average actual-to-nominal ratio of the 100 ohm to 190 kohm resistors).
Parameter	CAL (From active calibration constants) CHECK (From calibration check constants) PREV (From previous calibration constants)
Response	(Float) The resistance reference value.
Example:	OHMREF? CHECK 1.000021902360723E+00
<b>OLDREF</b>	
Description	Overlapped command, ignored if not in remote.  Sets the calibrator's output to the previously-programmed reference value. (The same as pressing the ENTER key in local operation.)
Parameter	None.
<b>ONTIME?</b>	
Description	Sequential command.  Returns the time in minutes since the calibrator was turned on.
Parameters:	None.
Response	(Integer) Number of minutes since power-up this session.
<b>*OPC</b>	
Description	Sequential command.  Sets bit 0 (OPC for "Operation Complete") in the Event Status Register to 1 when all pending device operations are complete.
Parameter	None
Response	Sets bit 0 (OPC for "Operation Complete") in the Event Status Register to 1 when all pending device operations are complete.
Example:	After sending an OUT command, check if the output has settled by sending *OPC. As soon as the output has settled, a pending *OPC command sets bit 0 (OPC for "Operation Complete") in the Event Status Register to 1. The command to read the ESR is *ESR?.
<b>*OPC?</b>	
Description	Sequential command.  Causes program execution to pause until all operations are complete; returns a 1 upon completion of these operations. (See also *WAI.)
Parameter	None
Response	(Integer) "1" after all operations are complete.
Example:	If you had sent an OUT command, you can check if the output has settled by sending *OPC or *OPC?. As soon as the OUT command has completed (output settled), a pending *OPC command places a "1" in the output buffer to be read by the controller.

Table 5-2. Commands (continued)

<b>OPER</b>	
Description	Overlapped command, ignored if not in remote. Activates the calibrator's output if in standby. OPER is inhibited for outputs 22V and over, if there are faults in the fault queue (see "Fault Queue").
Parameter	None
<b>*OPT?</b>	
Description	Sequential command. Returns a list of analog modules installed in the calibrator, including any auxiliary amplifiers that are attached.
Parameter	None
Response	(Series of strings) A list of the modules and auxiliary amplifiers, separated by commas.
Example:	"5725A Attached","5215A Attached"
<b>OUT</b>	
Description	Overlapped command, ignored if not in remote. Sets the output of the calibrator and establishes a new reference point for shifting the output to determine UUT error. If only one parameter is supplied, the calibrator makes the minimum change needed to comply with the requested output. For example, if the calibrator setting is 1V, 100 Hz and you send "OUT 2V", the setting changes to 2V, 100 Hz.
Parameters:	1. (Optional) Output amplitude with optional multiplier and unit. (At least one parameter must be sent.) 2. (Optional) Output frequency with optional multiplier and unit. (At least one parameter must be sent.)
Examples	OUT -15.2 V                    (-15.2V; frequency unchanged) OUT 188.3 MA, 442 HZ        (188.3 mA, 442 Hz) OUT 1.9 MOHM                (1.9 M $\Omega$ ) OUT 100 HZ                    (Sets the frequency only)
<b>OUT?</b>	
Description	Sequential command Returns the calibrator's output amplitude and frequency (does not include multipliers).
Parameter	None
Response	1. (Float) Output amplitude 2. (String) Units (V, DBM, A, or OHM) 3. (Float) Frequency (0 if dc or ohms)
Examples	1.256983E+01,V,0            (12.56983V) 1.883E-01,A,4.42E+02        (188.3 mA, 442 Hz) 1.9E+06,OHM,0                (1.9 M $\Omega$ )
<b>OUT_ERR?</b>	
Description	Sequential command. Returns the UUT error computed by the calibrator after using the INCR command to shift the output.
Parameter	None
Response	1. (Float) UUT error magnitude 2. (String) units for the above number (PPM, PCT, or DB)

**Table 5-2. Commands (continued)**

<b>PHASE</b>	
Description	Overlapped command, ignored if not in remote. Sets the phase output signal to lead or lag the main output signal by up to 180 degrees.
Parameter	Phase in degrees (-359 to 359, fractions ignored)
<b>PHASE?</b>	
Description	Sequential command. Returns the phase angle of the variable phase output signal, with respect to the main output signal.
Parameter	None
Response	(Integer) Phase in degrees (0 to 359, 0 if the output is not ac)
<b>PHASELCK</b>	
Description	Overlapped command, ignored if not in remote. Enables or disables external phase locking, when the calibrator is supplying an ac voltage.
Parameter	ON (Activates phase locking) OFF (Deactivates phase locking)
<b>PHASESFT</b>	
Description	Overlapped command, ignored if not in remote. Enables or disables the variable phase output, when the calibrator is supplying an ac voltage.
Parameter	ON (Activates variable phase output) OFF (Deactivates variable phase output)
<b>*PUD</b>	
Description	Sequential command. (Protected user data command.) Allows a string of bytes to be stored in nonvolatile memory. (The CALIBRATION switch must be enabled.) See the RPT_STR command.
Parameter	#0 \ <user &lt;ascii="" data\&gt;="" eoi&gt;<br="" feed="" line="" with=""></user> or #<non-zero digit> \ <digits\&gt; \<user="" data\&gt;<br=""></digits\&gt;> For both forms, the bytes received in the \ <user 63="" allowing="" are="" bytes.<br="" data\&gt;="" field="" in="" memory;="" nonvolatile="" stored="" to="" up=""></user> The first form accepts data bytes after the #0 until the ASCII Line Feed character is received with an EOI signal. In the second form, the non-zero digit specifies the number of characters (0 - 9, or ASCII 48 - 57 decimal), in the \ <digits\&gt; \<digits\&gt;="" \<user="" bytes="" data="" data\&gt;="" defines="" field="" field.="" field.<="" in="" number="" of="" td="" the="" user="" value=""> </digits\&gt;>
Example:	*PUD #0FLUKE<Line Feed with EOI> or *PUD #15FLUKE Both examples store the word FLUKE in the protected user data area.  <i>Note</i> <i>The 1 indicates that one digit must follow (in this case '5'), and the 5 indicates that five characters are in the remainder of the *PUD message (in this case, FLUKE).</i>

Table 5-2. Commands (continued)

<b>*PUD?</b>	
Description	Sequential command. Returns the contents of the *PUD (Protected User Data) memory.
Parameter	None
Response	#(non-zero digit) (digits) (user data)  The non-zero digit specifies the number of characters that will follow in the \<digits\> field. These characters are 0 through 9 (ASCII 48 through 57 decimal). The value of the number in the \<digits\> field defines the number of user data bytes that follow in the \<user data\> field. The maximum response is 64 characters.
Example	*PUD? Returns: "205FLUKE" assuming that this is stored as in the example for PUD* above.
<b>RANGE?</b>	
Description	Sequential command. Returns the present output range.
Parameter	None
Response	(String) Symbolic name of the range from Table 5-4.
<b>RANGELCK</b>	
Description	Overlapped command, ignored if not in remote.  Locks or unlocks the present output range. The range automatically unlocks if the output function changes, for example from dc volts to dc current.
Parameter	ON (Locks the range) OFF (Unlocks the range)
<b>RCOMP</b>	
Description	Overlapped command, ignored if not in remote.  While a resistance output 19 k $\Omega$ or lower is selected, RCOMP activates or deactivates two-wire ohms compensation circuitry.
Parameter	ON (Turns on the two-wire compensation circuitry) OFF (Turns off the two-wire compensation circuitry)
<b>REFOUT?</b>	
Description	Sequential command.  Returns the value of the reference, which is the output value of the calibrator the last time a new reference was established with an OUT, NEW_REF, or MULT.
Parameter	None
Response	1. (Float) Output amplitude 2. (String) Units (V, A, OHM, or DBM) 3. (String) Frequency (0 if dc)

**Table 5-2. Commands (continued)**

<b>RPT_STR</b>	
Description	Sequential command.  Loads the user report string. The user report string can be read on the Control Display in local operation, and appears on calibration reports. The CALIBRATION switch must be set to ENABLE.
Parameter	String of up to 40 characters
<b>RPT_STR?</b>	
Description	Sequential command.  Returns the user report string. The user report string can be read on the Control Display in local operation, and appears on calibration reports.
Parameter	None
Response	(String) Up to 40 characters
<b>*RST</b>	
Description	Overlapped command, ignored if not in remote.  (Reset.) Sets the calibrator to its power-up default state: 0V, 0 Hz, Standby, [BOOST] off, [W BND] off, [EX GRD] off, [EX SNS] off, phase lock off, phase shift off, range lock off, [SCALE] off, [OFFSET] off, two-wire compensation off, and entry limits set to defaults.  *RST does not affect any of the following: <ul style="list-style-type: none"> <li>• State of the IEEE-488 interface</li> <li>• Selected bus address</li> <li>• Status Register Enable setting</li> <li>• Contents of nonvolatile memory</li> </ul>
<b>SCALE</b>	
Description	Sequential command, ignored if not in remote.  Turns scaling on or off. (The same as pressing the SCALE key on the front panel.)
Parameters:	ON or OFF
<b>SCALE?</b>	
Description	Sequential command.  Returns the full-scale nominal and full-scale actual values set when SCALE more was turned on. If scaling is off, both responses one and two are "0.0."
Responses:	1. (Float) Nominal full-scale value 2. (Float) Actual full-scale value 3. (String) V, A, or DBM; units for the first two responses

Table 5-2. Commands (continued)

<b>SCAL_ERR?</b>	
Description	Sequential command. Returns the value of the scale error if scaling is on; otherwise, this command returns 0.0.
Parameter	None
Response	1. (Float) Scale error 2. (String) Units for scale error
<b>SP_EOF</b>	
Description	Sequential command, ignored if not in remote. Sets the End-Of-File character string for the RS-232-C serial interface. The EOF setting is saved when the power is turned off.
Parameters:	1. ASCII code (decimal) for the first character 2. ASCII code (decimal) for the second character (A "0" for parameter 1 or 2 means that there is no character in that position.)
<b>SP_EOF?</b>	
Description	Sequential command. Returns the End-Of-File character string.
Parameter	None
Response	1. (Integer) ASCII code in decimal for the 1st character 2. (Integer) ASCII code in decimal for the 2nd character (A "0" for response 1 or 2 means there is no character in that position.)
<b>SP_SET</b>	
Description	Sequential command, ignored if not in remote. Sets the serial port settings and saves them in nonvolatile memory.
Parameters:	One or more of the following, in any order: 1. Baud rate as 110, 300, 600, 1200, 2400, 4800, 9600, or 19200 2. TERM or COMP (See note below) 3. XON, RTS, or NOSTALL (Stall method) 4. DBIT7 or DBIT8 (Data bits) 5. SBIT1 or SBIT2 (Stop bits) 6. PNONE, PEVEN, PODD, or PIGNORE (Parity) 7. CR, LF, or CRLF (End-Of-Line)  <i>Note</i> <i>The TERM or COMP parameter sets the responses in serial remote control to be appropriate for interactive terminal use or operation under program control. Specifying TERM sets the remote port to expect a human operator using a terminal. Specifying COMP sets the remote port to expect a computer program to be controlling the calibrator. (This command has the same effect as setting Remote I/F to TERMINAL or COMPUTER in the RS-232C Port Setup Menu.)</i>
Defaults:	9600,TERM,XON,DBIT8,SBIT1,PNONE,CRLF
Example:	1200,COMP,XON,DBIT8,SBIT1,PEVEN,CRLF

**Table 5-2. Commands (continued)**

<b>SP_SET?</b>	
Description	Sequential command. Returns the serial port settings contained in nonvolatile memory.
Response	1. (Integer) One of these baud rates: 110, 300, 600, 1200, 2400, 4800, 9600, or 19200 2. (String) TERM or COMP (Response type) 3. (String) XON, RTS, or NOSTALL (Stall method) 4. (String) DBIT7 or DBIT8 (Data bits) 5. (String) SBIT1 or SBIT2 (Stop bits) 6. (String) PNONE, PEVEN, PODD, or PIGNORE (Parity) 7. (String) CR, LF, or CRLF (End-Of-Line)
Example:	9600,TERM,XON,DBIT8,SBIT1,PNONE,CRLF
<b>SP_TIME</b>	
Description	Sequential command, ignored if not in remote. Sets the timeout period for the RS-232-C serial interface. (Timeout is the time the interface waits after being stalled before aborting the communication session.) The timeout setting is saved even when the power is turned off.
Parameter	0, No timeout 1 to 30, Timeout period in seconds
<b>SP_TIME?</b>	
Description	Sequential command. Returns the timeout period for the RS-232-C serial port. Timeout is the time the interface waits after being stalled before aborting the communication session.
Parameter	None
Response	0, No timeout (the interface will wait forever) 1 to 30, Timeout period in seconds
<b>*SRE</b>	
Description	Sequential command. Loads a byte into the Service Request Enable register (SRE), described under "Checking the Calibrator's Status."
Parameter	The decimal equivalent of the binary number to load into the register.
Example:	*SRE 56 Enables bits 3 (IIR), 4 (MAV), and 5 (ESR) in the Service Request Enable register.
<b>*SRE?</b>	
Description	Sequential command. Returns the byte from the Service Request Enable register, described under "Checking the Calibrator's Status."
Parameter	None
Response	(Integer) The decimal equivalent of the register byte.
Example:	*SRE? Returns: "56" if bits 3 (IIR), 4 (MAV), and 5 (ESR) are enabled (1) and the rest of the bits are disabled (0). (See "Checking the Calibrator's Status" for details.)

Table 5-2. Commands (continued)

<b>STATE?</b>																					
Description	Sequential command. Returns the long-term state of the calibrator.																				
Parameter	None																				
Response	(Integer) Gross state, with the following responses: <table border="0" style="width: 100%;"> <tr> <td style="width: 50%;">0 Operating</td> <td style="width: 50%;">10 Calibration, wideband positive gain</td> </tr> <tr> <td>1 Self diagnostics</td> <td>11 Calibration, wideband negative gain</td> </tr> <tr> <td>2 Self diagnostics halted by a fault</td> <td>12 Wideband flatness calibration</td> </tr> <tr> <td>3 Calibration check</td> <td>13 Range calibration</td> </tr> <tr> <td>4 DC zeros calibration</td> <td>14 5725A voltage diagnostics</td> </tr> <tr> <td>5 Calibration, +dc reference</td> <td>15 5725A current diagnostics</td> </tr> <tr> <td>6 Calibration, -dc reference</td> <td>16 5725A voltage troubleshooting</td> </tr> <tr> <td>7 Calibration, 1Ω reference</td> <td>17 5725A current troubleshooting</td> </tr> <tr> <td>8 Calibration, 10 kΩ reference</td> <td>18 Analog output tripped to dormant</td> </tr> <tr> <td>9 Calibration, internal adjustment</td> <td>19 Starting up</td> </tr> </table> 2. (String) Substate: If operating, self calibrating, diagnosing, or testing, returns a descriptive string of the activity underway.	0 Operating	10 Calibration, wideband positive gain	1 Self diagnostics	11 Calibration, wideband negative gain	2 Self diagnostics halted by a fault	12 Wideband flatness calibration	3 Calibration check	13 Range calibration	4 DC zeros calibration	14 5725A voltage diagnostics	5 Calibration, +dc reference	15 5725A current diagnostics	6 Calibration, -dc reference	16 5725A voltage troubleshooting	7 Calibration, 1Ω reference	17 5725A current troubleshooting	8 Calibration, 10 kΩ reference	18 Analog output tripped to dormant	9 Calibration, internal adjustment	19 Starting up
0 Operating	10 Calibration, wideband positive gain																				
1 Self diagnostics	11 Calibration, wideband negative gain																				
2 Self diagnostics halted by a fault	12 Wideband flatness calibration																				
3 Calibration check	13 Range calibration																				
4 DC zeros calibration	14 5725A voltage diagnostics																				
5 Calibration, +dc reference	15 5725A current diagnostics																				
6 Calibration, -dc reference	16 5725A voltage troubleshooting																				
7 Calibration, 1Ω reference	17 5725A current troubleshooting																				
8 Calibration, 10 kΩ reference	18 Analog output tripped to dormant																				
9 Calibration, internal adjustment	19 Starting up																				
<b>*STB?</b>																					
Description	Sequential command. Returns the status byte. The status byte is described under "Status Information."																				
Parameter	None																				
Response	(Integer) Decimal equivalent of the status byte.																				
Example:	*STB? Returns: "72" if bits 3 (EAV) and 6 (MSS) are set (1) and the rest of the bits are reset (0).																				
<b>STBY</b>																					
Description	Overlapped command, ignored if not in remote. Puts the calibrator in standby.																				
Parameter	None																				
<b>STOP_PR</b>																					
Description	Sequential command, ignored if not in remote. Stops printing a report.																				
Parameter	None																				
<b>*TST?</b>																					
Description	Sequential command, ignored if not in remote. Initiates a series of self-tests, then returns a "0" for pass or a "1" for fail. If any faults are detected, they are logged into the fault queue where they can be read by the FAULT? query.																				
Parameter	None																				
Response	(Integer) 0 (for Pass) or 1 (for Fail)																				

**Table 5-2. Commands (continued)**



<b>UNCERT?</b>	
Description	Sequential command. Returns the calculated maximum uncertainty of the calibrator's output according to the selected calibration interval. (The same as pressing  from the front panel.)
Parameter	None
Response	1. (Float) Uncertainty of the calibrator's output (-1.0 if no specification is available) 2. (String) Units for response 1 (PPM, PCT, V, A, OHM, etc.) 3. (Integer) The specification interval in days.
<b>VOUT?</b>	
Description	Sequential command. Returns the output amplitude expressed in volts if the currently selected units are dBm.
Parameter	None
Response	1. (Float) Output amplitude 2. (String) V, A, OHM; units for response 1 3. (Float) Frequency
Example:	Assuming a value of 10 dBm, 10 kHz is currently active on the main output terminals, VOUT? returns: "2.4494897E+00,V,1.0000E+04"
<b>*WAI</b>	
Description	Sequential command. (Wait-to-Continue.) This command prevents further remote commands from being executed until all previous remote commands have been executed. (See also *OPC.)
Parameter	None
Example:	If you had sent an OUT command, you can cause the calibrator to wait until the output has settled before continuing on to the next command by following OUT with a *WAI command. This is useful because OUT is an overlapped command, which means the calibrator would normally go on to process other commands before completing the OUT command.
<b>WBAND</b>	
Description	Overlapped command, ignored if not in remote. Activates or deactivates output from the Wideband AC Module (Option 5700A-03). This has the same action as pressing  from the front panel during local operation.
Parameter	ON or OFF

Table 5-3. Serial Remote Control Commands

<b>LOCAL</b>	
Description	Sequential command. Enables the local state. This command duplicates the IEEE-488-GTL (Go to Local) message.
Parameter	None
<b>LOCKOUT</b>	
Description	Sequential command. Enables the local lockout state. This command duplicates the IEEE-488 LLO (Local Lockout) message.
Parameter	None
<b>REMOTE</b>	
Description	Sequential command. Enables the remote state. This command duplicates the IEEE-488 REN (Remote Enable) message.
Parameter	None

Table 5-4. Range Identifiers for Remote Commands

<b>Function</b>	<b>Ranges</b>				
DC Voltage	DC220MV DC5205V	DC22V DC11V	DC1100V	DC2_2V	DC220V
DC Current	DC220UA DC5725A	DC 220A DC22MA	DC5220A	DC2_2MA	DC2_2A
AC Voltage	AC2_2MV AC5215V	AC22V AC220MV	AC5205V AC1100V	AC22MV AC5725V	AC220V AC2_2V
AC Current	AC220UA AC5725A	AC220MA AC22MA	AC5220A	AC2_2MA	AC2_2A
Resistance	OHM0 OHM1M OHM10K OHM100	OHM190 OHM1_9 OHM10M OHM100K	OHM190K OHM19K OHM19 OHM100M	OHM1 OHM1_9M OHM19K	OHM1K OHM10 OHM19M
Wideband	WB1_1MV WB3_5V	WB33MV WB11MV	WB1_1V WB330MV	WB3_3MV	WB110MV

## 5-22. Local-to-Remote State Transitions

The calibrator can be operated either locally from the front panel, or remotely, by responding to remote control commands. In addition to front panel and remote control operation, the controller can be placed in a local lockout condition at any time by remote command. When combined, the local, remote, and lockout conditions yield four possible operating states:

- Local (Front Panel Operation)

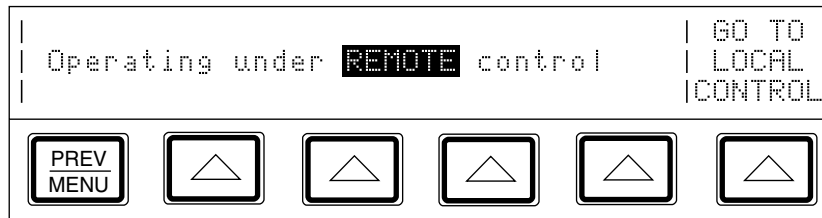
The calibrator responds to local and remote commands, but only remote commands that do not affect the state of the calibrator are allowed to execute. (For example OUT?, which returns the value of the calibrator's output setting is executable in the local state, but OUT, which sets the output to another value cannot be executed in local state.)

- Local with Lockout

Local with lockout is identical to local, except the calibrator will go into the remote with lockout state instead of the remote state when it receives a remote command. The local with lockout state is entered by executing the LOCKOUT statement from an IEEE-488 controller, or by sending the LOCKOUT command from a serial controller.

- Remote

When the Remote Enable (REN) line is asserted and the controller addresses the calibrator as a listener, it enters the remote state. These conditions are met, for example, when a 1722A executes the BASIC statement "REMOTE \ PRINT @4 'OUT 10MV'" if the calibrator's address is 4. In the remote state, Control Display changes to:



Front panel operation is restricted to use of the power switch and the "Go To Local Control" softkey. Pressing this softkey or sending the GTL (Go To Local) interface message returns the calibrator to the local state. (One way to send the GTL interface message in some controllers is by executing the LOCAL statement.)

- Remote with Lockout

The remote with lockout state can be entered from remote or local with lockout, but not directly from local. Remote with lockout is similar to the remote state, but restricted: the “Go To Local Control” softkey label does not appear on the Control Display. To return the calibrator to the local with lockout state, the GPIB controller sends GTL. (With some IEEE-488 controllers, you can do this manually by executing a WBYTE statement.) To return the calibrator to the local state, the GPIB controller unasserts the REN control line. (In BASIC, this is accomplished by sending the LOCAL command.) When the calibrator is in remote with lockout, the Control Display appears as follows for some controllers:

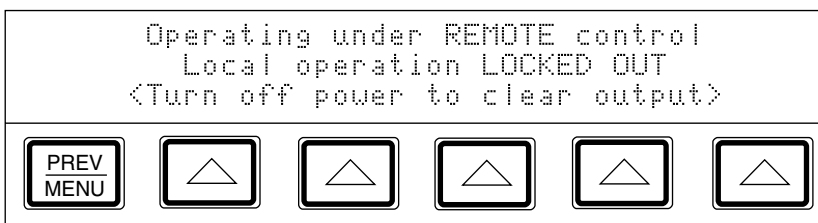


Table 5-5 summarizes the possible Remote/Local state transitions.

**Table 5-5. Operating State Transitions**

From	To	Use	Typical GPIB Command	1722A Serial Command
Local	Remote	MAL + REN	REMOTE	REMOTE
	Local/Lockout	LLO + REN	LOCKOUT	LOCKOUT
Remote	Local	GTL or GO TO LOCAL CONTROL softkey	LOCAL	LOCAL
	Remote/Lockout	LLO + REN	LOCKOUT	LOCKOUT
Local/Lockout	Remote/Lockout	MLA + REN	REMOTE or any calibrator command	REMOTE
Remote/Lockout	Local	REN not	LOCAL	LOCAL
	Local/Lockout	GTL	Manually using WBYTE	None

### **5-23. Checking the Calibrator's Status**

The controller has access to six status registers for the calibrator, which indicate the calibrator's conditions in the as shown in Figure 5-1. Each register bit is explained under separate headings for each register. Table 5-6 lists each register and its remote commands.

In addition to the status registers, the Service Request control line, SRQ (available only when using an IEEE-488 controller) and a 16-element buffer called the Fault Queue provide status information.

**Table 5-6. Status Register Summary**

<b>Register</b>	<b>READ Command</b>	<b>WRITE Command</b>	<b>Enable Register</b>
Serial Poll Status Byte (STB) (or SPL( ) for some controllers)	*STB?	None	SRE
Service Request Enable Register (SRE)	*SRE?	*SRE	None
Event Status Register (ESR)	*ESR?	None	ESE
Event Status Enable Register (ESE)	*ESE?	*ESE	None
Instrument Status Register (ISR)	ISR?	None	None
Instrument Status Change Register (ISCR)	ISCR?	None	ISCE
Instrument Status Change Enable Register (ISCE)	ISCE?	ISCE	None



**5-24. Serial Poll Status Byte**

The most important and frequently used register is the serial poll status byte, which is the calibrator's response to a serial poll. This byte is cleared (set to 0) when the power is turned on. You cannot do a serial poll if you are using the RS-232C port as the remote control interface. Instead, you can send the \*STB? command to get the same information. Its bits are defined as follows (bits 7, 1, and 0 are always 0):

7	6	5	4	3	2	1	0
0	RQS	ESB	MAV	EAV	ISCB	0	0
	MSS						

- RQS** Requesting Service. The RQS bit is set to 1 whenever bits ESB , MAV, EAV, or ISCB change from 0 to 1 and are enabled (bit 1) in the SRE. When RQS is 1, the calibrator asserts the SRQ control line on the IEEE-488 interface. You can do a serial poll to read this bit to see if the calibrator is the source of an SRQ.
- MSS** Master Summary Status. Set to 1 whenever bits ESB, MAV, EAV, or ISCB are 1 and enabled (bit 1) in the SRE. This bit can be read using the \*STB? command in serial remote control in place of doing a serial poll.
- ESB** Set to 1 when one or more enabled ESR bits are 1.
- MAV** Message Available. The MAV bit is set to 1 whenever data is available in the calibrator's IEEE-488 interface output buffer.
- EAV** Error (fault) available. A fault has occurred and a fault code is available through the FAULT? query.
- ISCB** One or more enabled ISCR bits are 1.

### 5-25. Service Request Line (SRQ)

Service Request (SRQ) is an IEEE-488.1 bus control line that the calibrator asserts to notify the controller that it requires some type of service. Many instruments can be on the bus, but they all share a single SRQ line. To determine which instrument set SRQ, the Controller normally does a serial poll of each instrument. The calibrator asserts SRQ whenever the RQS bit in its Serial Poll Status Byte is 1. This bit informs the controller that the calibrator was the source of the SRQ.

The calibrator clears SRQ and RQS whenever the controller performs a serial poll of the calibrator's IEEE-488 interface, sends \*CLS, or whenever the MSS bit is cleared. The MSS bit is cleared only when ESB, MAV, EAV, and ISCB are 0, or they are disabled by their associated enable bits in the SRE register being set to 0.

### 5-26. Service Request Enable Register

The Service Request Enable Register (SRE) enables or masks the bits of the Serial Poll Status Byte. The SRE is cleared at power up. Refer to "Serial Poll Status Byte" for the bit functions.

### 5-27. Loading the SRE

By resetting (to 0) the bits in the SRE, you can mask (disable) associated bits in the serial poll status byte. Bits set to 1 enable the associated bit in the serial poll status byte. The following sample program enables the ESB bit.

```

10 ! THIS PROGRAM SETS ESB IN THE SRE
20 GOSUB 90! GET AND PRINT OLD SRE
30 A% = A% + 32% ! ENABLE ESB (BIT 5)
40 PRINT @4, "*SRE ";A% ! "
60 GOSUB 90! GET AND PRINT NEW SRE
80 END
90 PRINT @4, "*SRE?" ! ASK FOR THE SRE CONTENTS
100 INPUT @4, A%! RETRIEVE THE REGISTER CONTENTS
110 PRINT "SRE = ";A%
120 RETURN

```

### 5-28. Event Status Register

The Event Status Register is a two-byte register in which the higher eight bits are always 0, and the lower eight bits except bits 6 and 1 represent various conditions of the calibrator. The ESR is cleared (set to 0) when the power is turned on, and every time it is read.

A mask register called the Event Status Enable register (ESE) allows the controller to enable or mask (disable) each bit in the ESR. When a bit in the ESE is 1, the corresponding bit in the ESR is enabled. When any enabled bit in the ESR is 1, the ESB bit in the Serial Poll Status Byte also goes to 1. The ESR bit stays 1 until the controller reads the ESR or does a device clear, a selected device clear, or sends the reset or \*CLS command to the calibrator. The ESE is cleared (set to 0) when the power is turned on.

### 5-29. Bit Assignments for the ESR and ESE

15	14	13	12	11	10	9	8
0	0	0	0	0	0	0	0

7	6	5	4	3	2	1	0
PON	0	CME	EXE	DDE	QYE	0	OPC

- PON** Power on. This bit is set to 1 if the power supply has been turned off and on since the last time the ESR was read.
- CME** Command error (fault). The calibrator's IEEE-488 interface encountered an incorrectly formed command. (The command FAULT? fetches the earliest fault code in the fault queue, which contains fault codes for the first 15 faults that have occurred.)
- EXE** Execution error (fault). A fault occurred when the calibrator tried to execute the last command. One possible cause for this error is a parameter that's out of range. (The command FAULT? fetches the earliest fault in the fault queue, which contains fault codes for the first 15 faults that have occurred.)
- DDE** Device-dependent error (fault). A fault related to a device-dependent command has occurred. One possible cause for this error would be an attempt to execute "OUT 100000V", which is outside the calibrator's range. (The command FAULT? fetches the earliest fault in the fault queue, which contains fault codes for the first 15 faults that have occurred.)
- QYE** Query error (fault). The calibrator was addressed to talk when no response data was available or appropriate, or when the controller failed to retrieve data on the output queue.
- OPC** Operation complete. All commands previous to reception of an \*OPC command have been executed, and the interface is ready to accept another message.

### 5-30. Reading the ESR and ESE

To read the contents of the ESR, send the remote command, \*ESR?. The ESR is cleared (set to 0) every time it is read. To read the contents of the ESE, send the remote command, \*ESE?. The ESE is not cleared when it is read. When you read either register, the calibrator responds by sending a decimal number that represents bits 0 through 15.

The following sample program retrieves the contents of both registers:

```

10 ! THIS PROGRAM READS THE ESR AND THE ESE REGISTERS
20 PRINT @4, "*ESR?"! ASK FOR THE ESR CONTENTS
30 INPUT @4, A! RETRIEVE THE REGISTER CONTENTS
40 PRINT @4, "*ESE?"! ASK FOR THE ESE CONTENTS
50 INPUT @4, B! RETRIEVE THE REGISTER CONTENTS
60 PRINT "ESR = ";A ! DISPLAY THE ESR REGISTER CONTENTS VALUE
70 PRINT "ESE = ";B ! DISPLAY THE ESE REGISTER CONTENTS VALUE
80 END

```

Convert the contents of variables A and B into binary, and you can read the status of the registers. For example if A is 32, its binary equivalent is: 00000000 00100000. Therefore, bit 5 (CME) in the ESR is set (1) and the rest of the bits are reset (0). This tells you that the calibrator has encountered a command fault. (It tried to execute an incorrectly formed command.)

### 5-31. Loading the ESE

By resetting the bits in the ESE, you can mask (disable) the associated bits in the ESR. For example, to prevent the occurrence of a command fault from causing bit 5 (ESB) in the serial poll status byte to go to 1, you can reset (to 0) bit 5 in the ESE register. The following sample program accomplishes this by checking the status of the CME bit, then toggling it if it is 1.

```

10 ! THIS PROGRAM RESETS BIT 5 (CME) IN THE ESE
20 PRINT @4, "*ESE 33" ! INITIAL ESE <-- EXE + OPC
30 GOSUB ! GET AND PRINT INITIAL ESE
40 IF (A% AND 32%) THEN A% = A% - 32% ! CLEAR EXE (BIT 5)
50 PRINT @4, "*ESE?" ! LOAD THE ESE WITH THE NEW VALUE
60 GOSUB 80 ! GET AND PRINT NEW ESE
70 END
80 PRINT @4, "*ESE?" !ASK FOR THE ESE CONTENTS
90 INPUT @4, A% !RETRIEVE THE REGISTER CONTENTS
100 PRINT "ESE = ";A%
110 RETURN

```

### 5-32. Instrument Status Register

The Instrument Status Register (ISR) gives the controller access to the state of the calibrator, including some of the information presented to the operator on the Control Display and the display annunciators during local operation.

### 5-33. Instrument Status Change Register

The Instrument Status Change Register (ISCR) indicates which ISR bits have changed status (from 0 to 1 or from 1 to 0) since the ISCR was last read. The ISCR is cleared (set to 0) when the calibrator is turned on, and every time it is read.

### 5-34. Instrument Status Change Enable Register

The Instrument Status Change Enable Register (ISCE) is a mask register for the ISCR. If a bit in the ISCE is enabled (set to 1) and the corresponding bit in the ISCR goes to 1, the ISCB bit in the Status Byte is set to 1. If all bits in the ISCE are disabled (set to 0), the ISCB bit in the Status Byte never goes to 1. The ISCE is cleared on power-up.

### 5-35. Bit Assignments for the ISR, ISCR, and ISCE

15	14	13	12	11	10	9	8
0	0	RPTBUSY	SETTLED	REMOTE	WBND	SCALE	OFFSET

7	6	5	4	3	2	1	0
PLOCK	PSHFT	RLOCK	RCOMP	BOOST	EXSENS	EXGARD	OPER

- RPTBUSY**    When 1, a calibration report is being printed to the serial port.
- SETTLED**    When 1, the output has stabilized to within specification.
- REMOTE**    When 1, the calibrator is under remote control.
- WBND**        When 1, the wideband is active.
- SCALE**        When 1, scaling is active.
- OFFSET**        When 1, an offset is active.
- PLOCK**        When 1, the calibrator's output is phase locked to an external source.
- PSHFT**        When 1, variable phase output is active.
- RLOCK**        When 1, the calibrator's output range is locked.
- RCOMP**        When 1, two-wired compensation is active when in resistance mode.
- BOOST**        When 1, an auxiliary amplifier is active.
- EXSENS**        When 1, external sensing is selected.
- EXGARD**        When 1, external voltage guard is selected.
- OPER**         When 1, the calibrator is operating, When 0, it is in standby.

### 5-36. Reading the ISR, ISCR, or ISCE

To read the contents of the ISR, send the remote command, ISR?. In a similar fashion, to read the contents of the ISCR, send ISCR?, and to read the contents of the ISCE, send ISCE?. The calibrator returns a decimal number representing bits 0 through 15. Every time you read the ISCR, its contents are zeroed. The following sample program reads all three registers:

```
10 ! THIS PROGRAM READS THE ISR, ISCR, AND ISCE REGISTERS
20 ! Note THAT THE ICSR? COMMAND ALSO CLEARS THE ISCR CONTENTS
30 PRINT @4, "ISR?" ! ASK THE ISR CONTENTS
40 INPUT @4, A% ! RETRIEVE THE REGISTER CONTENTS FROM THE 5700A
50 PRINT @4, "ISCR?" ! ASK FOR AND CLEAR THE ISCR CONTENTS
60 INPUT @4, B% ! RETRIEVE THE REGISTER CONTENTS FROM THE 5700A
70 PRINT @4, "ISCE?" ! ASK FOR THE ISCE CONTENTS
80 INPUT @4, C% ! RETRIEVE THE REGISTER CONTENTS FROM THE 5700A
90 PRINT "ISR = ";A% ! DISPLAY THE ISR
100 PRINT "ISCR = ";B% ! DISPLAY THE ISCR
110 PRINT "ISCE = ";C% ! DISPLAY THE ISCE
120 END
```

To read the status of the instrument, convert the returned variables into binary. For example if a register contains 4, its binary equivalent is: 00000000 00000100. Therefore, bit 3 (EXSNS) is set (1) and the rest of the bits are reset (0).

### 5-37. Loading the ISCE

By resetting the bits in the ISCE, you can mask (disable) the associated bits in the ISCR. For example, to cause an SRQ interrupt when an attached 5725A Amplifier turns on, bit 3 (BOOST) in the ISCE register must be 1. (The ISCB bit must also be enabled in the SRE.) The following sample program loads a decimal 8 into the ISCE, which sets bit 3 and resets the other bits:

```
10 ! THIS PROGRAM LOADS 00000000 00001000 BINARY INTO THE ISCE
20 PRINT @4, "ISCE 8" ! LOAD DECIMAL 8 INTO THE ISCE
30 PRINT @4, "ISCE?" ! READ BACK THE VALUE
40 INPUT @4, A% ! "
50 PRINT "ISCE = ";A% ! PRINT IT, IT SHOULD BE 8
60 END
```

### 5-38. Fault Queue

When a command fault, execution fault, or device-dependent fault occurs, its fault code is placed in the fault queue where it can be read by the FAULT? command. All fault codes are defined in Appendix A of this manual. Another way to decode a fault code is to send the command, EXPLAIN?, which returns a description of a fault code. Reading the first fault with the FAULT? command removes that fault from the queue. A response of 0 means the fault queue is empty.

The fault queue contains up to 16 entries. If many faults occur, only the first 15 faults are kept in the queue. A 16th entry in the queue is always a “fault queue overflow” fault, and all later faults are discarded until the queue is at least partially read. The first faults are kept, because if many faults occur before the user can acknowledge and read them, the earliest faults are the most likely to point to the problem. The later faults are usually repetitions or consequences of the original problem.

The OPER command is inhibited for outputs of 22V or greater whenever there is a fault in the fault queue. The OPER command remains inhibited until either the fault queue or the ESR is cleared.

#### *Note*

*You can check your calibrator's Main CPU software revision levels using the Instmt Config Menu, or \*IDN? remote command.*

After the calibrator has encountered a fault, you must do one of the following actions to reenble the OPER command:

1. Send \*CLS (to clear the ESR and fault queue)
2. Send \*ESR? (to read and clear the ESR)
3. Repeatedly send the FAULT? query until 0 is returned, indicating that you have read and cleared all faults from the queue.

### 5-39. IEEE-488 Interface Configuration

The calibrator's IEEE-488 interface supports the IEEE-488 interface function subsets listed in Table 5-7.

**Table 5-7. Supported IEEE-488 Interface Function Subsets**

Interface Function	Description
SH1	Complete source handshake capability
AH1	Complete acceptor handshake capability
T6	Basic talker; serial poll; no talk-only mode; unaddress if MLA
TEO	No extended talker capabilities
L4	Basic listener operation; no listen-only mode; unaddress if MTA
LEO	No extended listener capabilities
SR1	Full service request capability with ability to bit-mask SRQ
RL1	Full remoter/local capability including local lockout
PPO	No parallel poll capability
DC1	Device clear capability
DT0	No device trigger capability
C0	No bus control capability

## 5-40. Bus Communication Overview

Communication between the controller and the calibrator takes place using commands established by IEEE-488 standards and commands specifically related to the calibrator. The commands in Tables 5-1, 5-2, and 5-3 are all the remote commands, both common and device-dependent. Definitions of the different types of messages used on the IEEE-488 bus follow.

- Device-Dependent Commands

Device-Dependent commands are messages used to transfer information directly between the calibrator and the IEEE-488 controller. Some commands cause an action to take place in the calibrator. Others, called queries in the IEEE standards, ask for information, and always generate a response message from the instrument. While message format is governed by IEEE-488 standards, messages themselves can be unique to the calibrator. For example, device-dependent commands are used to set the output mode and amplitude, and to switch from standby to operate.

- Common Commands

IEEE standard 488.2 defines common commands, which are used for functions common to most bus devices. Examples include the command for resetting a device (\*RST) and the query for device identification (\*IDN?). Common commands and queries can be identified easily because they all begin with an asterisk (\*).

- Interface Messages

IEEE standards define interface messages, which manage the interface system. Some of the interface messages have their own control lines, and others are sent over the data lines by first asserting the control line ATN (Attention). An important thing to note about interface messages is that unlike device-dependent and common commands, interface messages are not sent literally (in a. For example, when you send a device-dependent query to the calibrator, the controller automatically sends the interface message MTA (My Talk Address).

### **5-41. Definition: Queries and Commands**

Messages directed to the calibrator fall naturally into two categories: commands and queries. Commands instruct the calibrator to do something or to set a value; no response is expected. Queries generally ask only for information from the calibrator; a response is always expected. Some queries also require the calibrator to take action. For example, the \*TST? query has the calibrator do a self test, then send the result to the controller. A query always ends with a question mark. A command never ends with a question mark. Tables 5-2 and 5-3 do not separate commands and queries; they are all called commands and are presented together in one alphabetical list.

All query responses are generated instantly on receipt of the query. In other words, queries generate their output when the calibrator executes the query rather than when the controller attempts to read the response. The calibrator simply generates the requested message and places it in an area of memory called the output buffer. When the controller addresses the calibrator as a talker, the contents of the output buffer are transmitted to the controller.

Some messages have both query and command forms (e.g., \*PUD and \*PUD?). In such cases, the command generally sets the value of a parameter and the query generally returns the most recent value of the parameter. Some messages are queries only (e.g., \*IDN?). Some messages are commands only (e.g., \*RST).

### **5-42. Functional Elements Of Commands**

Table 5-8 lists the functional elements of commands described by the IEEE-488.2 standard that are used by the calibrator. This table is for those who have a copy of the standard and want to use it to pursue additional information. The standard provides full definitions and syntax diagrams for each element.

**Table 5-8. Functional Elements of Commands**

Element	Function
PROGRAM MESSAGE	A sequence of zero or more PROGRAM MESSAGE UNIT elements, each of which is separated by a PROGRAM MESSAGE UNIT SEPARATOR element
PROGRAM MESSAGE UNIT	A command, programming data, or query received by the device.
COMMAND MESSAGE UNIT	A command or programming data received by the device.
QUERY MESSAGE UNIT	A query sent from the controller to the device.
PROGRAM DATA	Any of the six available program data types.
PROGRAM MESSAGE UNIT SEPARATOR	Separates the PROGRAM MESSAGE UNIT elements that comprise a PROGRAM MESSAGE.
PROGRAM HEADER SEPARATOR	Separates the header from the PROGRAM DATA.
PROGRAM DATA SEPARATOR	Separates PROGRAM DATA ELEMENTS listed under one header.
PROGRAM MESSAGE TERMINATOR	Terminates a PROGRAM MESSAGE.
COMMAND PROGRAM HEADER	Specifies a function or operation. Used with any associated PROGRAM DATA ELEMENTS.
QUERY PROGRAM HEADER	Similar to a COMMAND PROGRAM HEADER except that it contains a query indicator (?) since a response from the device is expected.
CHARACTER PROGRAM DATA	A data type suitable for sending short mnemonic data; generally used where a numeric data type is not suitable.
DECIMAL NUMERIC PROGRAM DATA	A data type suitable for sending decimal integers of decimal fractions, with or without exponents.
NON-DECIMAL NUMERIC PROGRAM DATA	A data type suitable for sending integer numeric representations in base 16, 8, or 2.
SUFFIX PROGRAM DATA	An optional field that follows DECIMAL NUMERIC PROGRAM DATA, and is used to indicate associated multipliers and units.
STRING PROGRAM DATA	A data type suitable for sending 7-bit ASCII character strings where the content needs to be hidden (by delimiters).
ARBITRARY BLOCK PROGRAM DATA	A data type suitable for sending blocks of arbitrary 8-bit information. Block size is limited to 1024 bytes.

### 5-43. Interface Messages

Interface messages manage traffic on the bus. Device addressing and clearing, data handshaking, and commands to place status bytes on the bus are all directed by interface messages. Some of the interface messages occur as state transitions of dedicated control lines. The rest of the interface messages are sent over the data lines with the ATN signal true. (All device-dependent and common commands are sent over the data lines with the ATN signal false.)

IEEE-488 standards define interface messages. Table 5-9 lists the interface messages that the calibrator accepts. Table 5-9 also shows the BASIC statement you execute on some controllers to generate the interface message. Table 5-10 lists the interface messages that the calibrator sends. The mnemonics listed in the tables are not sent in BASIC PRINT statements as commands are; in this way they are different from device-dependent and common commands.

Interface messages are handled automatically in most cases. For example, handshake messages DAV, DAC, and RFD automatically occur under the direction of an instrument's interface itself as each byte is sent over the bus.

**Table 5-9. Interface Messages Accepted by the Calibrator**

Mnemonic	Name	Function	Related Controller Command
ATN	Attention	A control line used to notify all instruments on the bus that the next data bytes are an interface message. If ATN is low, these data bytes are interpreted as device-dependent or common commands, addressed to a specific instrument.	None
DAC	Data Accepted	Sets the handshake signal line NDAC low.	None
DAV	Data Valid	Asserts the handshake signal line DAV.	None
DCL	Device Clear	Clears the input/output buffers.	CLEAR
END	End	A message that appears when the controller asserts the EOI signal line before sending a byte.	None
GTL	Go To Local	Transfers control of the calibrator from one of the remote states to one of the local states (See Table 5-5.)	LOCAL
LLO	Local Lockout	Transfers remote/local control of the calibrator. (See Table 5-5.)	LOCKOUT
IFC	Interface Clear	A control line that sets the interface to a quiescent state.	INIT
MLA	My Listen Address	Addresses a specific device on the bus as a listener. The controller sends MLA automatically whenever it directs a device-dependent or common query to a specific instrument.	None

**Table 5-9. Interface Messages Accepted by the calibrator (continued)**

MTA	My Talk Address	Addresses a specific device on the bus as a talker. The controller sends MTA automatically whenever it directs a device-dependent or common query to a specific instrument.	None
REN	Remote Enable	Transfers remote/local control of the calibrator. (See Table 5-5.)	REMOTE
RFD	Ready For Data	Set the handshake signal line NRFD low.	None
SDC	Selected Device Clear	Identical to DCL, but only operates when the calibrator is addressed as a listener.	CLEAR
SPD	Serial Poll Disable	Cancel a Serial Poll Enable.	Part of SPL
SPE	Serial Poll Enable	Causes the calibrator to return a Status Byte to the next command that address it as a listener, no matter what the command is.	Part of SPL
UNL	Unlisten	“Unaddresses” a specific device on the bus as a listener. The controller send UNL automatically after the device has successfully received a device-dependent or common command.	None
UNT	Untalk	“Unaddresses” a specific device on the bus as a listener. The controller sends UNT automatically after it receives the response from a device-dependent or common query.	None

**Table 5-10. Interface Messages Sent by the Calibrator**

Mnemonic	Name	Function
END	End	A message that appears when the calibrator asserts the EOI control line, which happens when the calibrator transmits the ASCII character LF for its termination sequence or terminator.
DAC	Data Accepted	Sets the handshake signal line NDAC low.
DAV	Data Valid	Asserts the handshake signal line DAV.
RFD	Ready For Data	Sets the handshake signal line NRFD low.
SRQ	Service Request	A control line that can be asserted by any device on the bus to indicate that it requires attention. For details, see “Checking the Calibrator’s Status.”
STB	Status Byte	The response sent to a serial poll (SPE) by the calibrator.

### 5-44. The IEEE-488 Connector

The IEEE-488 connector on the rear panel mates with an IEEE-488 Standard cable. The pin assignments of the rear-panel IEEE-488 connector are shown in Figure 5-2.

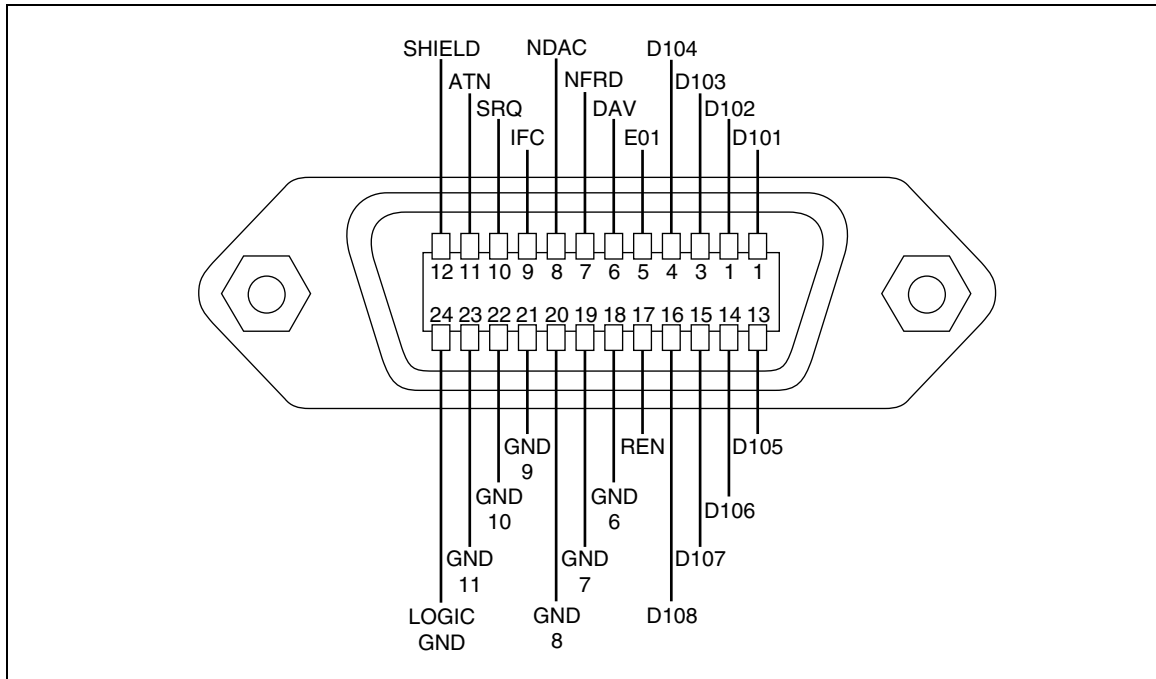


Figure 5-2. IEEE-488 Connector Pin Assignments

### 5-45. Remote Program Examples

The following programs are written in BASIC for the Fluke 1722A Instrument Controller.

### 5-46. Printing Main Output Calibration Shift Results

This program generates a printout of the changes in the magnitude of self correction generated at the last calibration. The printout contains the following information:

- A heading that shows the date, time, and calibrator's serial number
- Modules present (installed or attached)
- The most recent calibration dates and temperatures
- Data about the external standards used
- Values of the externally-calibrated internal references
- DC voltage output shifts for each range
- AC voltage output shifts for each range
- AC and dc current output shifts for each range
- Resistance shifts for each value
- 5725 Boost Amplifier output shifts (if attached)
- Wideband AC Module (Option 5700-03) output shifts (if installed)

```
10 REM THIS PROGRAM GENERATES A PRINTOUT OF
20 REM MAIN OUTPUT SHIFT RESULTS
30 INIT PORT 0 ! INITIALIZE THE INTERFACE
40 CLEAR PORT 0 ! SET THE 5700A TO ITS POWER-UP STATE
50 PRINT @4, "CAL_PR CAL" ! START CAL REPORT PRINTING
60 END
```

### 5-47. Verifying a Meter

The following program was written in BASIC for a typical instrument controller. This program selects 10V dc output, verifies that the calibrator is set to 10V, then triggers an 8840A to take a reading. It displays the calibrator's output, 8840A reading, and the meter error in ppm. The program assumes that the calibrator's bus address is 4 and the 8840A bus address is 1.

```
10 REM THIS PROGRAM VERIFIES THE ACCURACY OF AN 8840A AT 10V DC
20 INIT PORT 0 ! INITIALIZE THE INTERFACE
30 CLEAR PORT 0 ! "
40 PRINT @1, "F1 R0 S0 T2" ! SET 8840A FOR VDC, SLOW READ, AUTORANGE
50 PRINT @4, "OUT 10 V ; OPER" ! SET THE 5700A TO 10V DC,
60 PRINT @4, "*WAI; OUT?" ! WAIT FOR SETTLE, REQUEST OUTPUT VALUE
70 INPUT @4, V,U$,F ! GET THE DATA FROM THE 5700A
80 PRINT @1, "?" ! TRIGGER THE 8840A TO TAKE A READING
90 INPUT @1, VM ! GET THE DATA FROM THE 8840A
100 ER = ABS(V - VM) / V * 1E6 ! COMPUTE ERROR
110 PRINT "5700 OUTPUT:" ; V ; U$ ! PRINT THE RESULTS
120 PRINT "8840 MEASURED:" ; VM ; "V" !
130 PRINT "ERROR:" ; ER ; "PPM"
140 END
```

### 5-48. Remote Calibration

You can calibrate the 5700A/5720A Series II Calibrator remotely instead of using the front panel controls. For external calibration, you need to make connections to the calibrator's binding posts during the process, and you need to change the position of the rear panel CALIBRATION switch. The following paragraphs contain samples of each of the following programs:

- DC Zeros
- Calibration of the main output functions
- Range calibration
- Wideband AC Module (Option 5700A-03) calibration

### 5-49. DC Zeros

```
10 PRINT "Starting Zeros Calibration. Please wait . . . ."
20 PRINT @4, "CAL_ZERO;*OPC?" ! 5700A ADDRESS IS 4
30 INPUT @4, A
40 PRINT "Zeros calibration is finished."
50 END
```

## 5-50. Calibration

```

10 ! THIS IS A PROGRAM FOR REMOTE MAIN OUTPUT CALIBRATION
20 !
25 REMOTE
30 PRINT @4, "*CLS; *SRE 8" ! ENABLE EAV TO TRIGGER SRQ
40 ON SRQ GOTO 60 ! SRQ HANDLER
50 GOTO 140 ! START MAIN PROGRAM
60 PRINT @4, "FAULT?" \ INPUT @4, A% ! SRQ HANDLER, GET FAULT CODE
70 IF A% = 0 GOTO 120 ! IF NO FAULT EXIT
80 PRINT @4, "EXPLAIN? ";A% \ INPUT @4, A$ ! GET EXPLANATION
90 PRINT
100 PRINT "FAULT";A%;"OCCURRED: ";A$ ! DISPLAY EXPLANATION
110 GOTO 60! GET NEXT FAULT
120 A% = SPL(4%) ! SERIAL POLL TO CLEAR SP BYTE
130 RESUME 530 ! END OF SRQ HANDLER
140 PRINT "Ambient temperature in Celsius"; ! MAIN PROGRAM BEGINS
150 INPUT T ! GET TEMPERATURE FROM OPERATOR
160 PRINT @4, "CAL_TEMP";T ! SET CAL TEMPERATURE
170 PRINT "Connect the 10V standard as shown in the manual" \ GOSUB 470
180 PRINT "Enter the true value of 10V standard in volts"; \ INPUT V
190 PRINT "Doing 10V reference calibration. Please wait ..."
200 PRINT @4, "CAL_REF ";V;"V;*OPC" \ GOSUB 490
210 PRINT "Reverse the polarity of the leads" \ GOSUB 470
220 PRINT "Doing -10V reference calibration. Please wait ..."
230 V = -V ! SET THE VARIABLE FOR -10V CAL
240 PRINT @4, "CAL_REF ";V;"V;*OPC" \ GOSUB 490
250 PRINT "Connect the 10 kilohm standard to the output terminals"\GOSUB 470
260 PRINT "Enter the true value of the 10 kilohm standard in kilohms";
270 INPUT K1
280 PRINT "Doing 10 kilohm reference calibration. Please wait ..."
290 PRINT @4, "CAL_REF ";K1;"KOHM;*OPC" \ GOSUB 490
300 PRINT "Connect the 1 ohm standard to the output terminals"\GOSUB 470
310 PRINT "Enter the true value of the 1 ohm standard in ohms"; \ INPUT K2
320 PRINT "Doing 1 ohm reference calibration. Please wait ..."
330 PRINT @4, "CAL_REF ";K2;"OHM;*OPC" \ GOSUB 490
340 PRINT "Doing internal portion of calibration. Please wait ..."
350 PRINT @4, "CAL_ADJ;*OPC" \ GOSUB 490
360 PRINT "Calibration finished. Print a calibration report? [y, n]"
370 INPUT A$ \ IF LEFT(A$,1)="N" OR LEFT(A$,1)="n" GOTO 400
380 PRINT "Set up the peripheral device." \ GOSUB 470
390 PRINT "Printing . . ." \ PRINT @4, "CAL_PR CHECK;*OPC" \ GOSUB 490
400 PRINT "Store or discard the constants? [s, d]" \ INPUT A$
410 IF LEFT(A$,1)="D" OR LEFT(A$,1)="d" GOTO 530
420 PRINT "Set the CALIBRATION switch to ENABLE" \ GOSUB 470
430 PRINT "Saving the constants in memory . . ."
440 PRINT @4, "CAL_STORE;*OPC" \ GOSUB 490 ! SAVE THE CONSTANTS IN MEMORY
450 PRINT "Set the CALIBRATION switch to NORMAL" \ GOSUB 470 \ GOTO 530
470 PRINT "Press RETURN to continue" ! PAUSE FOR OPERATOR SUBROUTINE
480 INPUT A$ \ RETURN ! "
490 PRINT @4, "*ESR?" \ INPUT @4, A% ! WAIT FOR OPC SUBROUTINE
510 IF A% AND 1% THEN RETURN ! ", RETURN IF OPC BIT IS 1
520 GOTO 490 ! ", STAY IN LOOP IF OPC IS 0
530 PRINT "All finished!" \END

```

## 5-51. Calibration Check

```
10 ! THIS IS A PROGRAM FOR REMOTE CALIBRATION CHECK
20 !
30 REMOTE
40 PRINT @4, "*CLS; *SRE 8" ! ENABLE EAV TO TRIGGER SRQ
50 ON SRQ GOTO 70 ! SRQ HANDLER
60 GOTO 150 ! START MAIN PROGRAM
70 PRINT @4, "FAULT?" \ INPUT @4, A% ! SRQ HANDLER, GET FAULT CODE
80 IF A% = 0 GOTO 130 ! IF NO FAULT EXIT
90 PRINT @4, "EXPLAIN? ";A% \ INPUT @4, A$ ! GET EXPLANATION
100 PRINT
110 PRINT "FAULT";A%;"OCCURRED: ";A$ ! DISPLAY EXPLANATION
120 GOTO 70 ! GET NEXT FAULT
130 A% = SPL(4%) ! SERIAL POLL TO CLEAR SP BYTE
140 RESUME 300 ! END OF SRQ HANDLER
150 PRINT "Ambient temperature in Celsius"; ! MAIN PROGRAM BEGINS
160 INPUT T ! GET TEMPERATURE FROM OPERATOR
170 PRINT @4, "CAL_TEMP";T ! SET CAL TEMPERATURE
180 PRINT "Doing calibration check. Please wait . . ."
190 PRINT @4, "CAL_CHK;*OPC" \ GOSUB 270
200 PRINT "Calibration check finished. Print a report? [y, n]"
210 INPUT A$ \ IF LEFT(A$,1)="N" OR LEFT(A$,1)="n" GOTO 300
220 PRINT "Set up the peripheral device." \ GOSUB 250
230 PRINT "Printing ..." \ PRINT @4, "CAL_PR CHECK;*OPC" \ GOSUB 270 \ GOTO
300
250 PRINT "Press RETURN to continue" ! PAUSE FOR OPERATOR SUBROUTINE
260 INPUT A$ \ RETURN ! "
270 PRINT @4, "*ESR?" \ INPUT @4,A% ! WAIT FOR OPC SUBROUTINE
280 IF A% AND 1% THEN RETURN ! ", RETURN IF OPC BIT IS 1
290 GOTO 270 ! ", STAY IN LOOP IF OPC IS 0
300 PRINT "All finished!" \END
```

### 5-52. Wideband AC Module (Option 5700A-03) Gain Calibration

```

10 ! THIS IS A PROGRAM FOR REMOTE WIDEBAND (OPTION -03) GAIN CALIBRATION
20 ! WHICH IS PART OF ROUTINE CALIBRATION IF A WIDEBAND MODULE IS INSTALLED
30 !
40 REMOTE
50 PRINT @4, "*CLS ; *SRE 8" ! ENABLE FAULT TO TRIGGER SRQ
60 ON SRQ GOTO 80 ! SRQ HANDLER
70 GOTO 150 ! START MAIN PROGRAM
80 PRINT @4, "FAULT?" \ INPUT @4, A% ! SRQ HANDLER, GET FAULT CODE
90 IF A% = 0 GOTO 130 ! IF NO FAULT EXIT
100 PRINT @4, "EXPLAIN? ";A% \ INPUT @4, A$ ! GET EXPLANATION
110 PRINT "FAULT";A%;"OCCURRED: ";A$ ! DISPLAY EXPLANATION
120 GOTO 80 ! GET NEXT FAULT
130 A% = SPL(4%) ! SERIAL POLL TO CLEAR SP BYTE
140 RESUME 420
150 PRINT "Ambient temperature in Celsius"; ! MAIN PROGRAM BEGINS
160 INPUT T ! GET TEMPERATURE FROM OPERATOR
170 PRINT @4, "CAL_TEMP";T ! SET CAL TEMPERATURE
180 PRINT "Connect the wideband cable to the SENSE binding posts through the"
190 PRINT "50 ohm terminator with shield to LO as shown in the manual."
200 GOSUB 370 ! PAUSE FOR KEY
210 PRINT "Calibrating wideband positive gain, please wait ..."
220 PRINT @4, "CAL_WBGAIN PGAIN;*OPC" \ GOSUB 390 ! CALIBRATES POSITIVE GAIN
230 PRINT "Reverse the polarity at the SENSE binding posts."
240 GOSUB 370 ! PAUSE FOR KEY
250 PRINT "Calibrating wideband negative gain, please wait ..."
260 PRINT @4, "CAL_WBGAIN NGAIN;*OPC" \ GOSUB 390! CALIBRATES NEGATIVE GAIN
270 PRINT "Wideband gains calibration finished. Print a report? [y, n]"
280 INPUT A$ \ IF LEFT(A$,1)="N" OR LEFT(A$,1)="n" GOTO 310
290 PRINT "Set up the peripheral device." \ GOSUB 370
300 PRINT "Printing . . ." \ PRINT @4, "CAL_PR CHECK;*OPC" \ GOSUB 390
310 PRINT "Store or discard the constants? [s, d]" \ INPUT A$
320 IF LEFT(A$,1)="D" OR LEFT(A$,1)="d" GOTO 420
330 PRINT "Set the CALIBRATION switch to ENABLE" \ GOSUB 370
340 PRINT "Saving the constants in memory . . ."
350 PRINT @4,"CAL_WBGAIN STORE;*OPC" \ GOSUB 390 ! SAVE THE CONSTANTS
360 PRINT "Set the CALIBRATION switch to NORMAL" \ GOSUB 370 \ GOTO 420
370 PRINT "Press RETURN to continue" ! PAUSE FOR OPERATOR SUBROUTINE
380 INPUT A$ \ RETURN ! "
390 PRINT @4, "*ESR?" \ INPUT @4,A% ! WAIT FOR OPC SUBROUTINE
400 IF A% AND 1% THEN RETURN ! ", RETURN IF OPC BIT IS 1
410 GOTO 390 ! ", STAY IN LOOP IF OPC IS 0
420 PRINT "All finished!" \ END

```

**5-53. Using \*OPC?, \*OPC, and \*WAI**

The \*OPC?, \*OPC, and \*WAI commands let you maintain control of the order of execution of commands that could otherwise be passed up by subsequent commands.

If you had sent an OUT command, you can check if the output has settled by sending the query \*OPC?. As soon as the OUT command has completed (output settled), a 1 appears in the output buffer. You should always follow a \*OPC? command with a read command (for example, in BASIC, "INPUT @4, A"). The read command causes program execution to pause until the addressed instrument responds. The following sample program shows how you can use \*OPC?

```

10 PRINT @4, "OUT 100V,1KHZ;OPER; *OPC?"      ! 5700A ADDRESS IS 4
20 INPUT @4, A                                ! READ THE "1" FROM THE 5700A
30 !PROGRAM HALTS HERE UNTIL A "1" IS PUT INTO THE OUTPUT BUFFER
40 PRINT "OUTPUT SETTLED"

```

The \*OPC command is similar in operation to the \*OPC? query, except that it sets bit 0 (OPC for "Operation Complete") in the Event Status Register to 1 rather than sending a "1" to the output buffer. One simple use for \*OPC is to include it in a program in order for it to generate an SRQ (Service Request). Then an SRQ handler written into the program can detect the operation complete condition and respond appropriately. You can use \*OPC similarly to \*OPC?, except your program must read the ESR to detect the completion of all operations. The following sample program shows how you can use \*OPC.

```

10 REMOTE
20 PRINT @4, "OUT 100V,10HZ;*OPC"           ! 5700A ADDRESS IS 4
30 PRINT @4, "*ESR?"                        ! PUT THE ESR BYTE IN BUFFER
40 INPUT @4, A%                             ! READ THE ESR BYTE
50 IF (A% AND 1%) = 0% GOTO 30              ! TRY AGAIN IF NO OPC
60 PRINT "OUTPUT SETTLED"
70 END

```

The \*WAI command causes the calibrator to wait until any prior commands have been completed before continuing on to the next command, and takes no other action. Using \*WAI is a convenient way to halt operation until the command or commands preceding it have completed. The following sample program shows how you can use \*WAI.

```

10 REMOTE
20 PRINT @4, "OUT 100V,10HZ;*WAI"           ! 5700A ADDRESS IS 4
30 PRINT @4, "OUT?"                          ! READ THE OUTPUT VALUE
40 INPUT @4, A$, B$, C$                      ! A$ CONTAINS THE OUTPUT VALUE
50 PRINT "OUTPUT SETTLED"
60 PRINT "OUTPUT IS: ";A$;B$;" at ";C$
70 END

```

### 5-54. Writing an SRQ and Fault Handler

It is good practice to include fault (error) handling routines in your applications. The following sample Fluke 1722A Basic program lines show a method for halting program execution on occurrence of an SRQ (Service Request) on the bus, checking to see if the calibrator is the source of the SRQ, retrieving its fault messages, and acting on the faults. You should modify and extend this code as necessary for your application.

```

10     INIT PORTØ                ! IFC THE BUS
20     CLEAR PORTØ              ! DCL THE BUS
30     ! INITIALIZE THE 5700A SRQ HANDLER
40     PRINT @4, "*SRE 8"        ! ENABLE STB.EAV (FAULT AVAILABLE)
50     ON SRQ GOTO 1100         ! INSTALL SRQ HANDLER
60     ! BODY OF THE APPLICATION GOES HERE

1100  ! BUS SRQ HANDLER
1110  CLEAR PORTØ
1120  IF (SPL(4) AND 64) THEN GOSUB 1200 ! IF (STB.RQS) CALL 5700A SRQ
1130  ! TEST OTHER DEVICES RQS BITS IF DESIRED
1140  RESUME

1200  ! 5700A SRQ HANDLER
1210  IF (SPL(4) AND 8) THEN GOSUB 1300 ! IF (STB.EAV) CALL FAULT HANDLER
1220  ! TEST OTHER STB BITS IF DESIRED
1299  RETURN

1300  ! 5700A STB.EAV (FAULT) HANDLER
1310                                     ! DO {
1320  PRINT @4, "FAULT?"           !   READ AND CLEAR 5700A FAULT
1330  INPUT @4, E%                  !   READ IN THE FAULT NUMBER
1340  PRINT @4, "EXPLAIN? ";E%     !   GET THE EXPLANATION STRING
1350  INPUTLINE @4, E$              !   READ IN THE EXPLANATION STRING
1360  PRINT E%,E$                  !   PRINT USEFUL MESSAGE
1370  IF (E% <> Ø) THEN GOTO 1320  ! } UNTIL (NO MORE FAULTS)
1380  PRINT "PLEASE FIX THE SOURCE OF THESE FAULTS BEFORE CONTINUING"
1390  STOP                          !OTHER COMMANDS FOR YOUR APPLICATION
1399  RETURN

```

### 5-55. Emulating a Fluke 5100B or 5200A Calibrator

The 5700A/5720A Series II can be set to respond to either 5100B or 5200A remote commands by selecting the appropriate emulation mode. These emulation modes permit replacing either the 5100B or 5200A within an existing system without extensive reprogramming, although some minor alterations in the software may be necessary to accommodate some hardware differences. These differences are described in this section.

### 5-56. Entering Emulation Mode

You can set the 5700A/5720A Series II to operate in emulation mode by either sending the remote command (GAL L5100 or GAL L5200), or by selecting the correct menu options at the front panel.

In 1722A BASIC (using the IEEE-488 port) the command statement for activating emulation mode is:

```
10 PRINT @4, "GAL L5100"
```

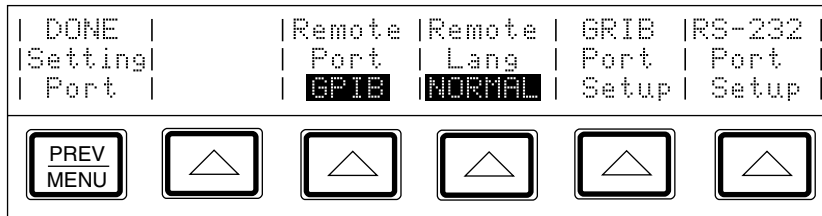
or

```
10 PRINT @4, "GAL L5200"
```

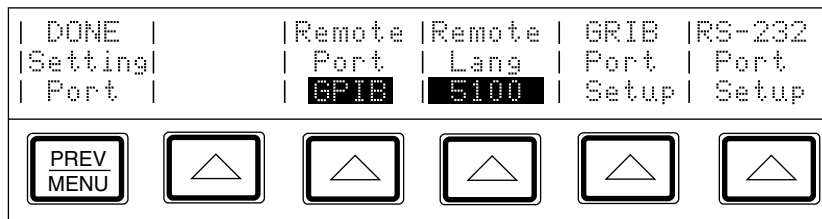
Once the calibrator receives this command, you can run remote programs written for the 5100B or 5200A (depending on which emulation mode you selected) and the calibrator will respond as if it were the instrument it is emulating.

To activate emulation mode from the front panel, follow these steps (for more details refer to “Bus Setup Procedure” at the beginning of this chapter).

1. From the Setup Menu, press “Instmt Setup”, then “Remote Port Setup.” The Remote Port Setup menu appears as shown below:



2. Press the softkey under “Remote Lang” until “5100” or “5200” appear. For example, if you are selecting 5100B emulation, the menu appears as follows:



Once you change the setting of the remote language, the new setting is stored in nonvolatile memory, and remains as the power-up default selection until it’s changed again in the Setup Menus.

### 5-57. Exiting Emulation Mode

When the calibrator is in 5100B or 5200A emulation mode, you can return back to the normal IEEE-488 remote operating mode by sending this statement:

```
10 PRINT @4, "~"
```

The tilde symbol (~) is the emulation mode command that complements the GAL (Go to Alternate Language) Command in the normal remote mode.

### 5-58. The 5720's Display During Emulation

While emulating the 5100B or the 5200A in Local control mode, the 5700A/5720A Series II displays the same output types and amplitudes as the instrument it's emulating. However, the displays shown on a 5100B or 5200A during remote operation are not duplicated on the 5700A/5720A Series II.

### 5-59. 5100B Emulation

This section describes all characteristics of the 5700A/5720A Series II that need to be taken into account when operating under 5100B emulation mode. These features that require attention are due to hardware differences between the two models, and only require minor programming alterations. The most significant differences are in the Ohms function, and programming examples are provided that illustrate the changes that are necessary to accommodate these differences.

#### *Note*

*While in 5100B emulation mode, the 5700A/5720A Series II cannot respond to the tape storage commands, described in Chapter 2 of the 5101B Operators Manual.*

### 5-60. Local-to-Remote Transitions

The 5700A/5720A Series II automatically changes its operating mode to remote control by responding to the IEEE-488.1 standard, which is in effect as soon as the calibrator receives remote programming commands. During local-to-remote transitions, when the 5100B language is selected, the 5700A/5720A Series II retains all settings that are fully compatible with the 5100B. If a setting has a value that cannot be processed by the 5100B, the 5700A/5720A Series II takes the actions described below.

- If the selected output is beyond the limits of a 5100B range, the output is set to 0 mV dc and a 5100B ERR6 is generated.
- If the selected output falls within a 5100B range, but contains a higher resolution (i.e., more significant digits) than the 5100B can process, the 5700A/5720A Series II rounds the output to the match the resolution of the 5100B.

Once in remote control, the following menu appears on the 5700A/5720A Series II display:



You can return to local operating mode by sending a remote command, or by pressing the softkey under “Go To Local Control.” For more information on remote to local transitions, refer to “Remote to Local State Transitions” earlier in this chapter.

### 5-61. Current Output Location

To ensure that the current output is available at the OUTPUT binding posts, set the current output location on the 5270A to NORMAL. If the current output location is set to AUX, the current will be available at the AUX CURRENT OUTPUT binding post, even during 5100B emulation.

### 5-62. Differences in the 5700A/5720A Series II and 5100B Ohms Function

There are some differences in the operation of the ohms function between the 5100B and the 5700A/5720A Series II. The 5100B generates nominal ohms values: if you request 100Ω, the 5100B sources 100Ω as closely as it can. In the 5700A/5720A Series II, if you request 100Ω, the 5700A/5720A Series II sources a characterized value that is close to 100Ω, and displays that characterized value. If the remote controller edits the resistance output, the edited value appears on the lower portion of the output display.

As with the 5100B, the GZ? command recalls the nominal resistance value. Included in the 5700A/5720A Series II emulator is a new recall option, GO, which returns the characterized ohms value for the present output. For an example of using the GO command, see the program example under the next heading.

**5-63. Ohms Remote Program Modifications for 5100B Emulation**

The following example programs illustrate the conversions that are required for running a 5100B resistance program on a 5700A/5720A Series II in 5100B emulation mode. Without these modifications, the 5700A/5720A Series II will still operate as a 5100B emulator, but the resistance accuracy is only the 5700A/5720A Series II tolerance to nominal, which is less accurate than a 5100B.

The shaded lines in these 5100B resistance programs are those that need to be modified in order for the programs to run on a 5700A/5720A Series II in 5100B emulation mode.

```

5   REM ORIGINAL 5100B PROGRAM
10  REM THIS PROGRAM SETS THE 5100B TO 10 KQ, READS THE VALUE OF A
20  REM FLUKE 8505A DMM AND CALCULATES THE ERROR.
30  RF = 10000.0
40  INIT PORT 0                ! CLEAR THE INTERFACE (SENDS DCL)
50  CLEAR PORT 0              ! SET THE 5700A TO ITS POWER-UP STATE
60  PRINT @1,"ZT0"            ! SET 8505 TO OHMS EXT TRIGGER
70  PRINT @4, RF;"Z,N"        ! SET THE 5100B TO 10KQ, OPERATE
80  WAIT 2000                 ! WAIT FOR OUTPUT TO SETTLE
90  PRINT @1, "?" \ INPUT @1,R ! TRIGGER AND READ THE 8505A
100 ER = ABS(RF-R)/RF * 1E6    ! COMPUTE ERROR IN PPM
110 PRINT "EXPECTED ";RF      ! PRINT RESULTS
120 PRINT "MEASURED ";R       ! "
130 PRINT "ERROR";ER;"PPM"    ! "

5   REM PROGRAM FOR A 5700A EMULATING A 5100B
10  REM THIS PROGRAM SETS THE 5100B TO 10 KQ, READS THE VALUE OF A
20  REM FLUKE 8505A DMM AND CALCULATES THE ERROR.
30  RF = 10000.0
40  INIT PORT 0                ! CLEAR THE INTERFACE (SENDS DCL)
50  CLEAR PORT 0              ! SET THE 5700A TO ITS POWER-UP STATE
60  PRINT @1,"ZT0"            ! SET 8505 TO OHMS EXT TRIGGER
70  PRINT @4, RF;"Z,N"        ! SET THE 5100B TO 10KQ, OPERATE
80  PRINT @4,"Y1GZ?"          ! GET ACTUAL OHMS VALUE
90  INPUT @4,RA                ! "
100 WAIT 2000                 ! WAIT FOR OUTPUT TO SETTLE
110 PRINT @1, "?" \ INPUT @1,R ! TRIGGER AND READ THE 8505A
120 ER = ABS(RA-R)/RA * 1E6    ! COMPUTE ERROR IN PPM
130 PRINT "EXPECTED ";RF      ! PRINT RESULTS
140 PRINT "ACTUAL ";RA        ! "
150 PRINT "MEASURED ";R       ! "
160 PRINT "ERROR";ER;"PPM"    ! "

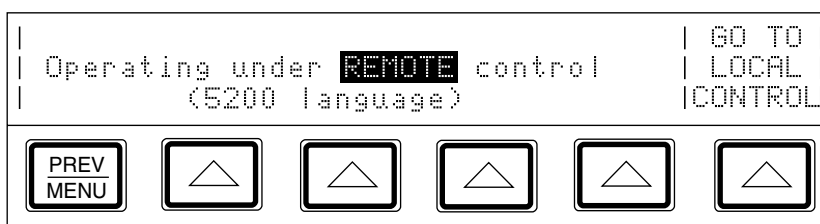
```

## 5-64. 5200A Emulation

Due to hardware differences between the 5200A and the 5700A/5720A Series II, there are some differences in characteristics, most notably the calibrator's behavior at certain voltage and frequency levels. All differences are described in this section.

## 5-65. Local-to-Remote Transitions

The 5700A/5720A Series II automatically changes its operating mode to remote control by responding to the IEEE-488.1 standard, which is in effect as soon as the calibrator receives remote programming commands. There are no hard switches to change when switching modes, as there are on the 5200A. Once in remote control during 5200A emulation, the following menu appears on the 5700A/5720A Series II's display:



To return to local operating mode, either send the remote programming command or press the softkey under "Go To Local Control." This procedure is a change from the 5200A, which returns to local operation when the hard switch is changed back to the position that initiates local operation. The configuration of the other hard switches on the 5200A's front panel determine the output's configuration when the 5200A returns to local operating mode and, if it's necessary, the 5200A's output changes to match the hard switches. When the 5700A/5720A Series II returns to local control it does not change its output.

For more information on remote to local transitions, see "Remote to Local State Transitions" earlier in this chapter.

## 5-66. Voltage and Frequency Ranges

The 5700A/5720A Series II voltage and frequency sourcing capabilities should be taken into account during 5200A emulation mode, since there are differences from the 5200A that may have an effect on programs that were written for the 5200A. Before you run your 5200A programs on the 5700A/5720A Series II be sure you review the differences described below so that you can modify your programs if necessary and ensure a trouble-free transition to the 5700A/5720A Series II.

- Voltage Limits

Unlike the 5200A, the 5700A/5720A Series II cannot source voltages between 100  $\mu\text{V}$  and 220  $\mu\text{V}$ . Furthermore, the 5700A/5720A Series II resets to 220  $\mu\text{V}$  @ 1 kHz when commanded to do so with a 5200A reset command. Voltages below 220  $\mu\text{V}$  will generate an error message on the 5700A/5720A Series II.

The 5700A/5720A Series II does not require a boost amplifier for sourcing voltages between 120V and 1100V, as the 5200A does. If the Operate command is received while in this voltage range, the 5700A/5720A Series II follows the command and enters operating mode, whereas the 5200A remains in standby.

- Voltage Range Boundaries

The voltage range boundaries in the 5700A/5720A Series II are different than those in the 5200A; therefore any discontinuities that can occur at voltage range boundaries will now appear at a different voltage. If you compensate for these discontinuities in your programs, you may wish to determine the new boundaries so that you can modify your programs accordingly.

Some examples of the difference in the voltage ranges are as follows: The 5200A sources 11.99999V in the 10V range, and 12V in the 100V range; the 5700A/5720A Series II sources 21.99999V in the 22V range, and 22V in the 220V range.

- **Frequency Limits**

Unlike the 5200A, the 5700A/5720A Series II cannot source frequencies between 1.1000 MHz and 1.1999 MHz. Instead, the 5700A/5720A Series II generates an out-of-range-error for all frequencies above 1.1000 MHz.

- **Programming Values Outside the Volt-Hertz Capability**

If you program a voltage or frequency that is outside the volt-hertz capability of the 5700A/5720A Series II, you will receive an out-of-range error. This is a change from the 5200A, which remains in operating mode and compensates for out-of-range values by maintaining the existing frequency, and reducing the voltage to the maximum the calibrator can source.

A graph displaying the volt-hertz capability is provided in the Specifications for AC Voltage. Refer to Chapter 1 for the 99%-level specifications, and to Appendix D for the 95%-level specifications.

### **5-67. Rounding Numeric Entries**

When a number is entered that is longer than the resolution of the 5700A/5720A Series II, the entry is rounded to the next highest value, whereas the 5200A truncates the entry. For example, the entry 119.999999V is rounded to 120.0000V in the 5700A/5720A Series II, but is truncated to 119.9999V in the 5200A.

### **5-68. Settling Times**

The 5700A/5720A Series II and the 5200A have different settling times. The 5700A/5720A Series II uses the SETTling bit for all programming commands; the 5200A used the SETTling bit only for voltage and frequency commands. After a GPIB command has been received, the 5700A/5720A Series II can take up to 60 ms to set the SETTling bit.

To determine if the 5700A/5720A Series II has settled, check the SETTling bit in either the serial poll status byte, or in the status message.

### **5-69. Programming External Sensing**

The 5700A/5720A Series II has some similarities to the 5200A when handling external sensing. You can still program external sensing at any output, and the external sensing feature automatically turns on and off as the output goes in and out of range, until external sense is explicitly turned off in your program. However, when programming external sense, you should take the following differences into account:

- Unlike the 5200A, the 5700A/5720A Series II cannot use external sense between 100 mV and 220 mV.
- If external sense is enabled and there is no signal at the SENSE terminals, an error condition occurs. The 5720A responds to this error condition by reverting to standby mode and generating a limit error. The 5200A remains in operating mode when this condition occurs; it does not report an error.

### **5-70. Overload Conditions**

When an overload condition occurs, both the 5200A and the 5270A calibrators generate a limit error. This limit error causes the 5700A/5720A Series II to revert to standby mode, unlike the 5200A, which remains in operating mode when overload occurs.

### **5-71. Phase Lock Errors**

If the phase lock is enabled, but the signal cannot be locked at the PHASE LOCK terminal, an error condition occurs. The 5700A/5720A Series II responds to this error condition by reverting to standby mode and generating a limit error. The 5200A remains in operating mode when this error occurs; it does not report an error.

# **Chapter 6**

## ***Using the RS-232C Serial Interface***

	<b>Title</b>	<b>Page</b>
6-1.	Introduction.....	6-3
6-2.	RS-232C Interface Specifications.....	6-3
6-3.	Setting Up and Connecting the Serial Interface.....	6-4
6-4.	Printing Calibration Reports.....	6-6
6-5.	Calibration Shift Results.....	6-6
6-6.	Calibration Check Shift Results.....	6-7
6-7.	Generating a Printout.....	6-8



### 6-1. Introduction

This chapter describes how to set up the RS-232C interface for remote control using protocol similar to IEEE-488, or to print or transmit data from the calibrator. After you set up the interface for remote control, refer to Chapter 5 for full details of remote operation. This chapter provides all details on printing or transmitting data.

The calibrator's RS-232C interface is designed in accordance with EIA (Electronic Industries Association) standard RS-232C. Through its RS-232C interface, the calibrator can be remotely controlled, and it can transmit its internal calibration constant values and other information to a printer, video-display terminal, or host computer.

### 6-2. RS-232C Interface Specifications

The RS-232C interface is configured as DTE (Data Terminal Equipment). A null-modem cable with two female 25-pin subminiature D connectors must be used to connect the calibrator to other DTE (Data Terminal Equipment) such as printers, video-display terminals, or computers. Recommended cables are Fluke accessories Y1702 or Y1703.

The pinout for the calibrator's RS-232C Connector is shown in Figure 6-1. The choices available and the defaults for all programmable interface parameters are shown in Table 6-1.

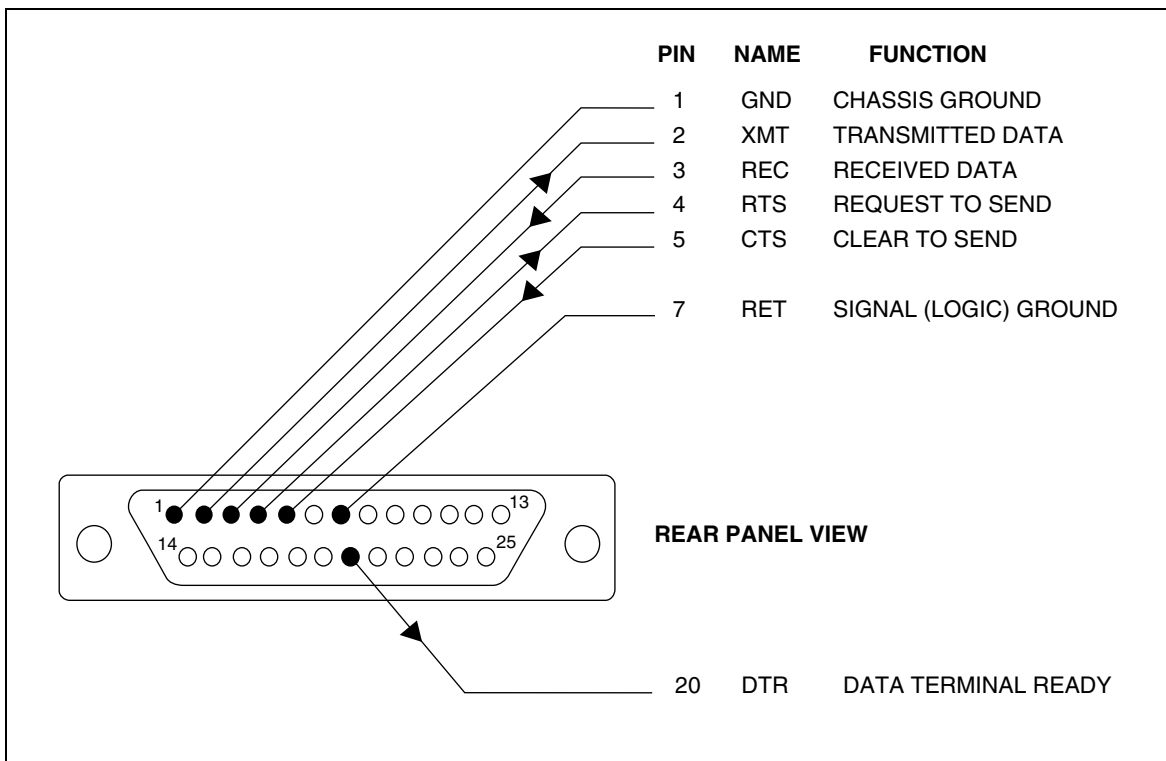


Figure 6-1. RS-232C Connector Pinout

Table 6-1. RS-232C Interface Parameter Choices

Parameter	Choices	Default Setting
Data Bits	7 or 8	8
Stop Bits	1 or 2	1
Flow Control	Ctrl S/Ctrl Q, (XON/XOFF), RTS, or none	Ctrl S/ Ctrl Q
Parity Checking	Odd, even, or none	None
Baud Rate	110, 300, 600, 1200, 2400, 4800, 9600, or 19200	9600
Timeout Period	0 to 30 seconds	0 (no timeout)
EOL (End of Line)	CR, LF, or CR LF	CR LF
EOF (End of File)	Any two ASCII characters	No characters

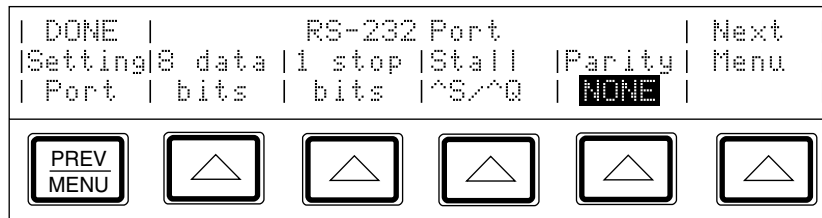
### 6-3. Setting Up and Connecting the Serial Interface

Refer to the specifications for your peripheral device, and proceed as follows to set up the serial interface for your application:

1. Turn off the power. Connect an RS-232C null-modem cable such as Fluke accessory Y1702 or Y1703 to the rear panel RS-232C connector and to the peripheral device.
2. Power up the calibrator.
3. Press the following sequence of softkeys:

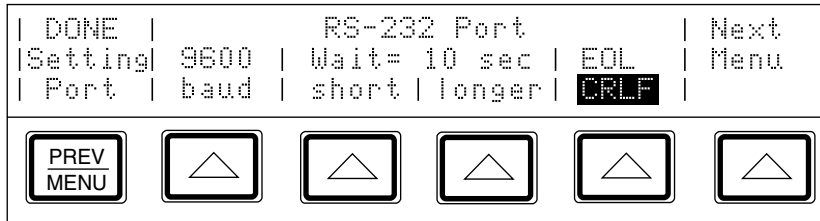
“Setup Menus” → “Instmt Setup” → “Remote Port Setup” → “RS-232 Port Setup”

The display changes to:

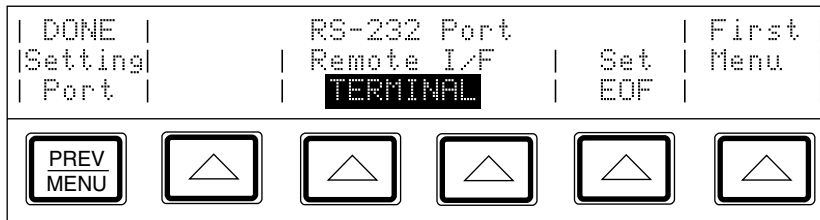


4. Set the number of data bits with the “data bits” softkey.
5. Set the number of stop bits with the “stop bits” softkey.
6. Select a method of stall control with the “Stall” softkey.
7. Select the parity mode with the “Parity” softkey.

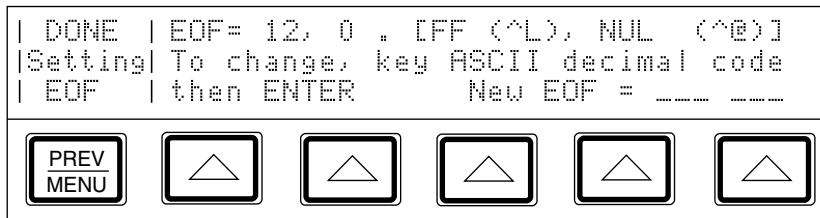
8. Press the “Next menu” softkey. The display changes to:




9. Set the baud rate with the “baud” softkey.
10. Set the timeout period with the “shorter” or “longer” softkey. (Timeout is the length of time the calibrator waits before aborting the current process after receiving a flow control command, and is programmable between 0 to 30 seconds. A setting of 0 causes the calibrator to wait forever after receiving a stall command.)
11. Press the “EOL” softkey to set the EOL (End Of Line) character to either CR, LF, or the string CR LF.
12. Press the “NEXT menu” softkey. The display changes to:



13. This step needs to be done only if you are setting up the interface for remote control of the calibrator. Press one of the softkeys under “Remote I/F” to set the label to “Terminal” or “Computer.”
- “Terminal” sets the remote port to expect a human operator to be using a terminal attached to the RS-232C port to control the calibrator. This setting has the same effect as specifying TERM in the SP\_SET remote command parameter string.
- “Computer” sets the remote port to expect a computer to be controlling the calibrator over the RS-232C port. This setting has the same effect as specifying “COMP” in the SP\_SET remote command parameter string.
14. To designate a character or character string as the EOF (End Of File) character, press the “EOF” softkey. The display changes to:



15. Enter the decimal code of the ASCII character(s) designated as EOF. (Appendix C contains a table of ASCII codes.) Verify that your selection is correct as shown on the display.
16. To exit the setup menus, press  five times.

## **6-4. Printing Calibration Reports**

Calibration reports are available for calibration check and calibration. The following paragraphs describe what you can print and how to do it.

### *Note*

*Reports can only be printed through the serial port when it is not being used as the remote control port. (They can be printed through the IEEE-488 port.)*

## **6-5. Calibration Shift Results**

The Calibration Shift Results printout presents all adjustments made to stored zero-offset and gain constants, as a result of any drift detected at the most recent calibration. The printout contains the following information:

- Heading containing the date, time, and user report string
- Modules present (installed or attached)
- Most recent calibration dates and temperatures
- Space for recording information about external standards used
- Values of externally calibrated internal references
- DC voltage output shifts for each range
- AC voltage output shifts for each range
- Current output shifts for each range (ac and dc)
- Resistance shifts for each value
- 5725A Amplifier output shifts (if attached)
- Wideband AC Module (Option 5700A-03) output shifts (if installed)

## **6-6. Calibration Check Shift Results**

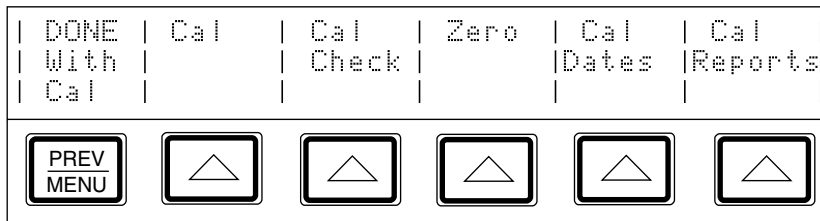
The Calibration Check Shift Results printout present changes in the magnitude of self correction generated by calibration check. Calibration check uses internal standards rather than external standards as the basis for comparison, and does not make permanent changes to calibration constants. Chapter 1 describes how to use calibration check to develop a performance history. The printout contains the following information:

- Heading that shows the date, time, and user report string
- Modules present (installed or attached)
- Most recent calibration dates and temperatures
- Values of externally-calibrated internal references
- DC voltage output shifts for each range
- AC voltage output shifts for each range
- AC and dc current output shifts for each range
- Resistance shifts for each value
- 5725A Boost Amplifier output shifts (if attached)

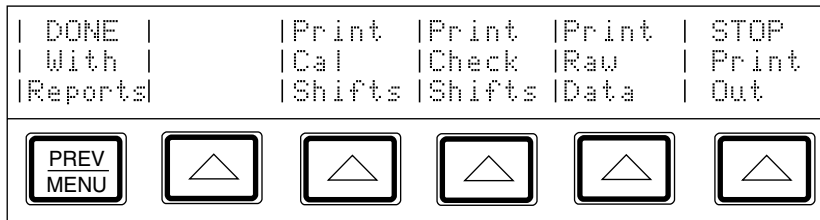
## 6-7. Generating a Printout

Follow the procedure below to generate a printout of calibration shift result. Make sure the serial interface is configured for compatibility with your peripheral device and is attached with an RS-232C cable. The output will be paginated for a 66-line page.

1. Press the “Setup Menus” softkey; then press the “Cal” softkey. The calibration menu appears as shown below.

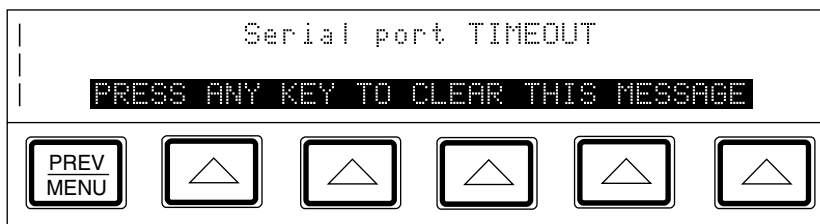


2. Press the “Cal Reports” softkey. The calibration reports menu appears as shown.



3. Select one of the following softkeys to generate the printout you prefer:
  - To print the main output calibration shift results press the “Print Cal Shifts” softkey (see Figure 6-2).
  - To print the calibration check shift results, press the “Print Check Shifts” softkey.
  - To print raw calibration constant data as shown in Figure, press the “Print Raw Data” softkey.

If you have difficulty generating the printout, make sure the correct cable is attached to the peripheral device, and the interface parameters are set to the correct values. If the input buffer of the peripheral device fills, and the device sends the calibrator a stall command, the calibrator will stop sending data and will start a timer. If the timeout period expires, printing is aborted and the following message appears on the display:



To remove the message, press any key.

The output is paginated with Line Feed characters to format a 66-line page.

```

-----
FLUKE CORPORATION (1)      S/N 1824760 (2)      5720A OUTPUT CALIBRATION (3)
PRINTED ON 12/14/95 AT 14:04:24 5720A
-----
                                MODULES PRESENT
-----
Software Revision 0.2+A+* (4)
Switching Matrix
DC Volt Module
AC Volt Module
220V Module (5)
1100V/2A Module
Current Module
Ohms Module
Wideband Module
Hires Osc Module
-----
                                ARTIFACT CALIBRATION DATES AND TEMPERATURES
-----
Specification Interval:      90day      Confidence      99%

MAIN OUTPUT:      (Most recent) 12/06/88, 22.9 Degrees C (6)
                  (Previous)  9/07/88, 23.2 Degrees C
                  (Days since last cal) 43

ZERO:      (Most recent) 1/05/89
           (Days since last cal) 13

WIDEBAND GAIN: (Most recent) 12/06/88, 23.0 Degrees C (7)
              (Previous)  9/07/88, 23.3 Degrees C
              (Days since last cal) 43

WIDEBAND FLAT: (Most recent) 12/06/88, 22.9 Degrees C (8)
              (Previous)  9/07/88, 23.3 Degrees C
              (Days since last cal) 43
-----
                                STANDARDS USED
-----
STANDARD      NUMBER      CERT. DATE
VOLTAGE
10 kOhm
1 Ohm
OTHER
-----
                                EXTERNALLY CALIBRATED INTERNAL REFERENCES
-----
REFERENCE      Most Recent      Previous      Shift (ppm)
6.5 V DC Reference      6.548268      6.548268      0.00
13 V DC Reference      13.082727      13.082725      0.20
10 kOhm Reference      1.002937      1.002938      -0.11 (10)
1.0 Ohm Resistor      1.0000967      1.0000980      -1.32
1.9 Ohm Resistor      1.8992432      1.8992446      -0.72
-----
                                (11)      (12)      (13)
    
```

Figure 6-2. Calibration Shift Results Printout

DC VOLTAGE OUTPUT SHIFTS								
RANGE	Point	Zero Shift	Full Scale Shift			Spec	Shift	
(14)	(15)	(16)	(17)			(+/-) (18)	(% spec) (19)	
220 mV	+FS	-0.00020 mV	-0.00085 mV	-3.87 ppm	10.41 ppm	-37.18		
	-FS	-0.00017 mV	0.00047 mV	2.12 ppm	10.41 ppm	20.39		
2.2V	+FS	0.0000003 V	-0.0000011 V	-0.48 ppm	6.55 ppm	-7.32		
	-FS	0.0000006 V	0.0000018 V	0.82 ppm	6.55 ppm	12.46		
11V	+FS	0.000001 V	0.000001 V	0.05 ppm	5.36 ppm	0.85		
	-FS	0.000002 V	0.000001 V	0.09 ppm	5.36 ppm	1.60		
22V	+FS	-0.000001 V	0.000005 V	0.21 ppm	5.36 ppm	3.87		
	-FS	0.000002 V	0.000001 V	0.03 ppm	5.36 ppm	0.56		
220V	+FS	-0.00006 V	0.00020 V	0.91 ppm	6.45 ppm	14.08		
	-FS	-0.00003 V	-0.00028 V	-1.26 ppm	6.45 ppm	-19.45		
1100V	+FS	-0.0002 V	-0.0001 V	-0.09 ppm	8.55 ppm	-1.01		
	-FS	-0.0001 V	-0.0001 V	-0.05 ppm	8.55 ppm	-0.53		

AC VOLTAGE OUTPUT SHIFTS							
RANGE	Point	Full Scale Shift			Spec	Shift	
	(20)				(+/-)	(% spec)	
2.2 mV	FS	-0.000018 mV	-0.0008 %	0.24 %	-0.34		
	20.00 kHz	-0.000013 mV	-0.0006 %	0.24 %	-0.24		
	50.00 kHz	-0.000017 mV	-0.0008 %	0.26 %	-0.30		
	100.00 kHz	-0.000017 mV	-0.0008 %	0.45 %	-0.17		
	119.99 kHz	-0.000018 mV	-0.0008 %	0.80 %	-0.10		
	0.1200 MHz	-0.000019 mV	-0.0009 %	0.80 %	-0.11		
	0.2000 MHz	-0.000041 mV	-0.0019 %	0.80 %	-0.23		
	0.3000 MHz	-0.000008 mV	-0.0003 %	0.80 %	-0.04		
	0.4000 MHz	-0.000002 mV	-0.0001 %	1.53 %	-0.01		
	0.5000 MHz	0.000028 mV	0.0013 %	1.53 %	0.08		
	0.6000 MHz	0.000007 mV	0.0003 %	1.69 %	0.02		
	0.7000 MHz	0.000021 mV	0.0010 %	1.69 %	0.06		
	0.8000 MHz	0.000021 mV	0.0009 %	1.69 %	0.06		
	0.9000 MHz	0.000031 mV	0.0014 %	1.69 %	0.08		
	1.0000 MHz	0.000032 mV	0.0015 %	1.69 %	0.09		
	1.1000 MHz	0.000036 mV	0.0016 %	NO SPEC	0.00		
1.1999 MHz	0.000042 mV	0.0019 %	NO SPEC	0.00			
22 mV	FS	-0.00008 mV	-3.48 ppm	382.73 ppm	-0.91		
	20.00 kHz	-0.00009 mV	-3.90 ppm	382.73 ppm	-1.02		
	50.00 kHz	-0.00004 mV	-1.70 ppm	642.73 ppm	-0.26		
	100.00 kHz	-0.00004 mV	-0.0002 %	0.13 %	-0.13		
	119.99 kHz	0.00001 mV	0.0000 %	0.19 %	0.01		
	0.1200 MHz	0.00002 mV	0.0001 %	0.19 %	0.04		
	0.2000 MHz	0.00024 mV	0.0011 %	0.19 %	0.58		
	0.3000 MHz	-0.00005 mV	-0.0002 %	0.19 %	-0.11		
	0.4000 MHz	-0.00001 mV	-0.0001 %	0.31 %	-0.02		
	0.5000 MHz	0.00006 mV	0.0003 %	0.31 %	0.09		
	0.6000 MHz	0.00009 mV	0.0004 %	0.47 %	0.08		
	0.7000 MHz	-0.00003 mV	-0.0001 %	0.47 %	-0.03		
	0.8000 MHz	0.00022 mV	0.0010 %	0.47 %	0.21		
	0.9000 MHz	0.00033 mV	0.0015 %	0.47 %	0.32		
	1.0000 MHz	0.00050 mV	0.0023 %	0.47 %	0.49		
	1.1000 MHz	0.00024 mV	0.0011 %	NO SPEC	0.00		
1.1999 MHz	0.00192 mV	0.0087 %	NO SPEC	0.00			

Figure 6-2. Calibration Shift Results Printout (continued)

220 mV	FS	-0.0015	mV	-6.93	ppm	145.45	ppm	-4.76
	20.00	kHz	-0.0010	mV	-4.57	ppm	145.45	ppm
	50.00	kHz	-0.0015	mV	-6.75	ppm	375.45	ppm
	100.00	kHz	-0.0014	mV	-6.51	ppm	936.36	ppm
	119.99	kHz	-0.0015	mV	-0.0007	%	0.11	%
	0.1200	MHz	-0.0017	mV	-0.0008	%	0.11	%
	0.2000	MHz	-0.0039	mV	-0.0018	%	0.11	%
	0.3000	MHz	-0.0005	mV	-0.0002	%	0.11	%
	0.4000	MHz	0.0001	mV	0.0000	%	0.19	%
	0.5000	MHz	0.0031	mV	0.0014	%	0.19	%
	0.6000	MHz	0.0010	mV	0.0005	%	0.38	%
	0.7000	MHz	0.0024	mV	0.0011	%	0.38	%
	0.8000	MHz	0.0023	mV	0.0011	%	0.38	%
	0.9000	MHz	0.0033	mV	0.0015	%	0.38	%
	1.0000	MHz	0.0035	mV	0.0016	%	0.38	%
	1.1000	MHz	0.0038	mV	0.0017	%	NO SPEC	0.00
	1.1999	MHz	0.0045	mV	0.0020	%	NO SPEC	0.00
2.2V	FS	-0.000010	V	-4.58	ppm	78.18	ppm	-5.86
	20.00	kHz	-0.000005	V	-2.22	ppm	78.18	ppm
	50.00	kHz	-0.000010	V	-4.40	ppm	139.09	ppm
	100.00	kHz	-0.000009	V	-4.16	ppm	286.36	ppm
	119.99	kHz	-0.000010	V	-4.46	ppm	508.18	ppm
	0.1200	MHz	-0.000011	V	-5.16	ppm	508.18	ppm
	0.2000	MHz	-0.000033	V	-15.17	ppm	508.18	ppm
	0.3000	MHz	0.000000	V	0.14	ppm	508.18	ppm
	0.4000	MHz	0.000006	V	0.0003	%	0.13	%
	0.5000	MHz	0.000036	V	0.0016	%	0.13	%
	0.6000	MHz	0.000015	V	0.0007	%	0.27	%
	0.7000	MHz	0.000029	V	0.0013	%	0.27	%
	0.8000	MHz	0.000029	V	0.0013	%	0.27	%
	0.9000	MHz	0.000038	V	0.0017	%	0.27	%
	1.0000	MHz	0.000040	V	0.0018	%	0.27	%
	1.1000	MHz	0.000043	V	0.0020	%	NO SPEC	0.00
	1.1999	MHz	0.000050	V	0.0023	%	NO SPEC	0.00
22V	FS	0.00000	V	0.07	ppm	78.18	ppm	0.09
	20.00	kHz	-0.00001	V	-0.35	ppm	78.18	ppm
	50.00	kHz	0.00004	V	1.85	ppm	139.09	ppm
	100.00	kHz	0.00004	V	1.89	ppm	268.18	ppm
	119.99	kHz	0.00008	V	3.79	ppm	627.27	ppm
	0.1200	MHz	0.00010	V	4.33	ppm	627.27	ppm
	0.2000	MHz	0.00032	V	14.40	ppm	627.27	ppm
	0.3000	MHz	0.00003	V	1.41	ppm	627.27	ppm
	0.4000	MHz	0.00007	V	0.0003	%	0.15	%
	0.5000	MHz	0.00014	V	0.0006	%	0.15	%
	0.6000	MHz	0.00016	V	0.0007	%	0.32	%
	0.7000	MHz	0.00005	V	0.0002	%	0.32	%
	0.8000	MHz	0.00030	V	0.0014	%	0.32	%
	0.9000	MHz	0.00041	V	0.0019	%	0.32	%
	1.0000	MHz	0.00058	V	0.0026	%	0.32	%
	1.1000	MHz	0.00032	V	0.0015	%	NO SPEC	0.00
	1.1999	MHz	0.00200	V	0.0091	%	NO SPEC	0.00
220V	FS	-0.0004	V	-1.60	ppm	84.55	ppm	-1.89
	5.000	kHz	0.0013	V	5.81	ppm	84.55	ppm
	10.000	kHz	0.0009	V	3.91	ppm	84.55	ppm
	20.00	kHz	-0.0031	V	-13.95	ppm	84.55	ppm
	50.00	kHz	-0.0003	V	-1.49	ppm	238.18	ppm
	100.00	kHz	-0.0004	V	-1.94	ppm	595.45	ppm

**Figure 6-2. Calibration Shift Results Printout (continued)**

	119.99	kHz	0.0018	V	0.0008	%	0.20	%	0.40
	0.1200	MHz	0.0019	V	0.0009	%	0.20	%	0.44
	0.2000	MHz	0.0040	V	0.0018	%	0.20	%	0.92
	0.3000	MHz	0.0142	V	0.0064	%	0.20	%	3.22
	0.4000	MHz	0.0288	V	0.0131	%	0.57	%	2.29
	0.5000	MHz	0.0266	V	0.0121	%	0.57	%	2.12
	0.6000	MHz	0.0506	V	0.0230	%	1.35	%	1.70
	0.7000	MHz	0.0613	V	0.0279	%	1.35	%	2.07
	0.8000	MHz	0.0546	V	0.0248	%	1.35	%	1.84
	0.9000	MHz	0.0580	V	0.0264	%	1.35	%	1.95
	1.0000	MHz	0.0782	V	0.0355	%	1.35	%	2.63
1100V	FS		0.000	V	0.14	ppm	83.64	ppm	0.17
	0.3000	kHz	-0.000	V	-0.29	ppm	83.64	ppm	-0.35
	0.5000	kHz	-0.009	V	-8.54	ppm	83.64	ppm	-10.21
	0.7000	kHz	-0.004	V	-3.45	ppm	83.64	ppm	-4.13
	1.0000	kHz	-0.003	V	-2.41	ppm	83.64	ppm	-2.88

-----  
DC CURRENT OUTPUT SHIFTS  
-----

RANGE	Point	Zero Shift	Full Scale Shift			Spec (+/-)	Shift (% spec)
220 uA	+FS	-0.0005 uA	-0.0003 uA	-1.17	ppm	95.45 ppm	-1.23
	-FS	-0.0005 uA	-0.0007 uA	-3.15	ppm	95.45 ppm	-3.30
2.2 mA	+FS	-0.000005 mA	-0.000004 mA	-1.70	ppm	54.55 ppm	-3.11
	-FS	-0.000005 mA	-0.000005 mA	-2.47	ppm	54.55 ppm	-4.53
22 mA	+FS	-0.00005 mA	-0.00001 mA	-0.63	ppm	54.55 ppm	-1.15
	-FS	-0.00004 mA	-0.00007 mA	-3.33	ppm	54.55 ppm	-6.11
220 mA	+FS	-0.0005 mA	-0.0005 mA	-2.48	ppm	64.55 ppm	-3.84
	-FS	-0.0005 mA	-0.0004 mA	-1.82	ppm	64.55 ppm	-2.81
2.2A	+FS	-0.000005 A	-0.000022 A	-10.01	ppm	93.64 ppm	-10.70
	-FS	-0.000005 A	0.000012 A	5.57	ppm	93.64 ppm	5.95

-----  
AC CURRENT OUTPUT SHIFTS  
-----

RANGE	Point	Full Scale Shift			Spec (+/-)	Shift (% spec)		
220 uA	FS	0.000 uA		0.97	ppm	230.91 ppm	0.42	
	0.5000	kHz	0.002 uA		8.31	ppm	230.91 ppm	3.60
	1.0000	kHz	-0.000 uA		-0.40	ppm	230.91 ppm	-0.17
	2.000	kHz	-0.001 uA		-0.0003	%	0.53 %	-0.05
	5.000	kHz	0.000 uA		0.0001	%	0.53 %	0.02
	7.000	kHz	-0.001 uA		-0.0003	%	2.26 %	-0.01
	10.000	kHz	-0.002 uA		-0.0008	%	2.26 %	-0.04
2.2 mA	FS	0.00000 mA		0.37	ppm	158.18 ppm	0.23	
	0.5000	kHz	0.00001 mA		2.67	ppm	158.18 ppm	1.69
	1.0000	kHz	-0.00001 mA		-2.48	ppm	158.18 ppm	-1.57
	2.000	kHz	0.00000 mA		0.0002	%	0.17 %	0.11
	5.000	kHz	-0.00001 mA		-0.0006	%	0.17 %	-0.34
	7.000	kHz	-0.00001 mA		-0.0002	%	0.62 %	-0.04
	10.000	kHz	-0.00001 mA		-0.0004	%	0.62 %	-0.07
22 mA	FS	0.0000 mA		1.33	ppm	158.18 ppm	0.84	
	0.5000	kHz	0.0000 mA		0.40	ppm	158.18 ppm	0.25

Figure 6-2. Calibration Shift Results Printout (continued)

1.0000	kHz	0.0001	mA	2.83	ppm	158.18	ppm	1.79		
2.000	kHz	-0.0000	mA	-0.0002	%	0.12	%	-0.14		
5.000	kHz	0.0000	mA	0.0001	%	0.12	%	0.08		
7.000	kHz	-0.0001	mA	-0.0006	%	0.53	%	-0.11		
10.000	kHz	-0.0002	mA	-0.0009	%	0.53	%	-0.16		
220	mA	FS		-0.000	mA	-0.35	ppm	348.18	ppm	-0.10
0.5000	kHz	-0.001	mA	-2.91	ppm	348.18	ppm	-0.83		
1.0000	kHz	0.001	mA	2.48	ppm	348.18	ppm	0.71		
2.000	kHz	-0.000	mA	-2.17	ppm	977.27	ppm	-0.22		
5.000	kHz	-0.001	mA	-3.48	ppm	977.27	ppm	-0.36		
7.000	kHz	-0.001	mA	-0.0006	%	0.49	%	-0.13		
10.000	kHz	-0.004	mA	-0.0017	%	0.49	%	-0.34		
2.2A	FS	-0.00002	A	-7.81	ppm	668.18	ppm	-1.17		
0.5000	kHz	-0.00002	A	-8.74	ppm	668.18	ppm	-1.31		
1.0000	kHz	-0.00001	A	-6.32	ppm	668.18	ppm	-0.95		
2.000	kHz	-0.00002	A	-10.79	ppm	795.45	ppm	-1.36		
5.000	kHz	-0.00002	A	-8.13	ppm	795.45	ppm	-1.02		
7.000	kHz	-0.00003	A	-0.0015	%	0.91	%	-0.16		
10.000	kHz	-0.00004	A	-0.0018	%	0.91	%	-0.19		

RESISTANCE OUTPUT SHIFTS

Point		Full Scale Shift		Spec (+/-)	Shift (% spec)			
0.0000000	Ohm	0.0000000	Ohm	0.00	Ohm	0.00	Ohm	0.00
1.0000980	Ohm	-0.0000013	Ohm	-1.32	ppm	95.00	ppm	-1.39
1.8992446	Ohm	-0.0000014	Ohm	-0.72	ppm	95.00	ppm	-0.76
9.998777	Ohm	0.0000008	Ohm	0.75	ppm	28.00	ppm	2.69
18.996369	Ohm	-0.000101	Ohm	-5.30	ppm	26.00	ppm	-20.38
99.99425	Ohm	-0.00011	Ohm	-1.14	ppm	17.00	ppm	-6.73
189.97922	Ohm	-0.00037	Ohm	-1.95	ppm	17.00	ppm	-11.45
0.9999772	kOhm	0.0000006	kOhm	0.60	ppm	12.00	ppm	5.02
1.9000296	kOhm	-0.0000009	kOhm	-0.47	ppm	12.00	ppm	-3.90
10.001505	kOhm	-0.000001	kOhm	-0.07	ppm	11.00	ppm	-0.65
19.001801	kOhm	0.000006	kOhm	0.31	ppm	11.00	ppm	2.78
100.01559	kOhm	-0.00015	kOhm	-1.54	ppm	13.00	ppm	-11.84
190.02896	kOhm	-0.00005	kOhm	-0.26	ppm	13.00	ppm	-1.97
1.0001901	MOhm	-0.0000029	MOhm	-2.87	ppm	18.00	ppm	-15.94
1.9003599	MOhm	-0.0000016	MOhm	-0.84	ppm	19.00	ppm	-4.41
10.002007	MOhm	-0.000044	MOhm	-4.37	ppm	37.00	ppm	-11.81
19.001915	MOhm	-0.000038	MOhm	-2.00	ppm	47.00	ppm	-4.25
100.04720	MOhm	-0.00129	MOhm	-12.87	ppm	120.00	ppm	-10.72

WIDEBAND OUTPUT SHIFTS

RANGE	Point	Full Scale Shift	Spec (+/-)	Shift (% spec)					
1.1	mV	FS	0.25	uV	0.0224	%	0.44	%	5.14
	1.0000	kHz	0.25	uV	0.0224	%	0.44	%	5.14

Figure 6-2. Calibration Shift Results Printout (continued)

	12.00	kHz	0.25	uV	0.0224 %	0.44 %	5.14
	100.00	kHz	0.25	uV	0.0224 %	0.44 %	5.14
	0.5000	MHz	0.25	uV	0.0224 %	0.44 %	5.14
	1.1999	MHz	0.25	uV	0.0224 %	0.91 %	2.47
	1.2	MHz	-0.32	uV	-0.0287 %	0.91 %	-3.16
	2.0	MHz	-0.32	uV	-0.0287 %	0.91 %	-3.16
	10.0	MHz	-0.32	uV	-0.0287 %	0.91 %	-3.16
	20	MHz	-0.32	uV	-0.0287 %	0.91 %	-3.16
	30	MHz	-0.32	uV	-0.0287 %	3.30 %	-0.87
3.3	FS		0.00070	mV	0.0212 %	0.48 %	4.42
	1.0000	kHz	0.00070	mV	0.0212 %	0.48 %	4.42
	12.00	kHz	0.00070	mV	0.0212 %	0.48 %	4.42
	100.00	kHz	0.00070	mV	0.0212 %	0.48 %	4.42
	0.5000	MHz	0.00070	mV	0.0212 %	0.48 %	4.42
	1.1999	MHz	0.00070	mV	0.0212 %	0.67 %	3.16
	1.2	MHz	-0.00106	mV	-0.0322 %	0.67 %	-4.79
	2.0	MHz	-0.00106	mV	-0.0322 %	0.67 %	-4.79
	10.0	MHz	-0.00106	mV	-0.0322 %	0.87 %	-3.69
	20	MHz	-0.00106	mV	-0.0322 %	1.07 %	-3.00
	30	MHz	-0.00106	mV	-0.0322 %	2.07 %	-1.55
11	FS		0.0023	mV	0.0210 %	0.39 %	5.43
	1.0000	kHz	0.0023	mV	0.0210 %	0.39 %	5.43
	12.00	kHz	0.0023	mV	0.0210 %	0.39 %	5.43
	100.00	kHz	0.0023	mV	0.0210 %	0.39 %	5.43
	0.5000	MHz	0.0023	mV	0.0210 %	0.39 %	5.43
	1.1999	MHz	0.0023	mV	0.0210 %	0.51 %	4.08
	1.2	MHz	-0.0033	mV	-0.0302 %	0.51 %	-5.88
	2.0	MHz	-0.0033	mV	-0.0302 %	0.51 %	-5.88
	10.0	MHz	-0.0033	mV	-0.0302 %	0.61 %	-4.92
	20	MHz	-0.0033	mV	-0.0302 %	0.81 %	-3.71
	30	MHz	-0.0033	mV	-0.0302 %	1.41 %	-2.14
33	FS		0.0065	mV	0.0198 %	0.33 %	5.98
	1.0000	kHz	0.0065	mV	0.0198 %	0.33 %	5.98
	12.00	kHz	0.0065	mV	0.0198 %	0.33 %	5.98
	100.00	kHz	0.0065	mV	0.0198 %	0.33 %	5.98
	0.5000	MHz	0.0065	mV	0.0198 %	0.33 %	5.98
	1.1999	MHz	0.0065	mV	0.0198 %	0.44 %	4.50
	1.2	MHz	-0.0111	mV	-0.0337 %	0.44 %	-7.66
	2.0	MHz	-0.0111	mV	-0.0337 %	0.44 %	-7.66
	10.0	MHz	-0.0111	mV	-0.0337 %	0.54 %	-6.24
	20	MHz	-0.0111	mV	-0.0337 %	0.74 %	-4.55
	30	MHz	-0.0111	mV	-0.0337 %	1.34 %	-2.51
110	FS		0.012	mV	0.0114 %	0.34 %	3.38
	1.0000	kHz	0.012	mV	0.0114 %	0.34 %	3.38
	12.00	kHz	0.012	mV	0.0114 %	0.34 %	3.38
	100.00	kHz	0.012	mV	0.0114 %	0.34 %	3.38
	0.5000	MHz	0.012	mV	0.0114 %	0.34 %	3.38
	1.1999	MHz	0.012	mV	0.0114 %	0.44 %	2.59
	1.2	MHz	-0.044	mV	-0.0398 %	0.44 %	-9.06
	2.0	MHz	-0.044	mV	-0.0398 %	0.44 %	-9.06
	10.0	MHz	-0.044	mV	-0.0398 %	0.54 %	-7.38
	20	MHz	-0.044	mV	-0.0398 %	0.74 %	-5.38
	30	MHz	-0.044	mV	-0.0398 %	1.34 %	-2.97

Figure 6-2. Calibration Shift Results Printout (continued)

330	mV	FS	0.033	mV	0.0102 %	0.28 %	3.62
	1.0000	kHz	0.033	mV	0.0102 %	0.28 %	3.62
	12.00	kHz	0.033	mV	0.0102 %	0.28 %	3.62
	100.00	kHz	0.033	mV	0.0102 %	0.28 %	3.62
	0.5000	MHz	0.033	mV	0.0102 %	0.28 %	3.62
	1.1999	MHz	0.033	mV	0.0102 %	0.38 %	2.66
	1.2	MHz	-0.143	mV	-0.0433 %	0.38 %	-11.35
	2.0	MHz	-0.143	mV	-0.0433 %	0.38 %	-11.35
	10.0	MHz	-0.143	mV	-0.0433 %	0.48 %	-8.99
	20	MHz	-0.143	mV	-0.0433 %	0.68 %	-6.35
	30	MHz	-0.143	mV	-0.0433 %	1.28 %	-3.38
1.1V		FS	0.00011	V	0.0099 %	0.29 %	3.45
	1.0000	kHz	0.00011	V	0.0099 %	0.29 %	3.45
	12.00	kHz	0.00011	V	0.0099 %	0.29 %	3.45
	100.00	kHz	0.00011	V	0.0099 %	0.29 %	3.45
	0.5000	MHz	0.00011	V	0.0099 %	0.29 %	3.45
	1.1999	MHz	0.00011	V	0.0099 %	0.39 %	2.56
	1.2	MHz	-0.00045	V	-0.0413 %	0.39 %	-10.68
	2.0	MHz	-0.00045	V	-0.0413 %	0.39 %	-10.68
	10.0	MHz	-0.00045	V	-0.0413 %	0.49 %	-8.48
	20	MHz	-0.00045	V	-0.0413 %	0.69 %	-6.01
	30	MHz	-0.00045	V	-0.0413 %	1.29 %	-3.21
3.5V		FS	0.00030	V	0.0087 %	0.21 %	4.05
	1.0000	kHz	0.00030	V	0.0087 %	0.21 %	4.05
	12.00	kHz	0.00030	V	0.0087 %	0.21 %	4.05
	100.00	kHz	0.00030	V	0.0087 %	0.21 %	4.05
	0.5000	MHz	0.00030	V	0.0087 %	0.21 %	4.05
	1.1999	MHz	0.00030	V	0.0087 %	0.31 %	2.76
	1.2	MHz	-0.00148	V	-0.0423 %	0.31 %	-13.44
	2.0	MHz	-0.00148	V	-0.0423 %	0.31 %	-13.44
	10.0	MHz	-0.00148	V	-0.0423 %	0.41 %	-10.20
	20	MHz	-0.00148	V	-0.0423 %	0.61 %	-6.88
	30	MHz	-0.00148	V	-0.0423 %	1.21 %	-3.48

Figure 6-2. Calibration Shift Results Printout (continued)

Table 6-2. Annotation for Shift Results Printout

①	The date and time that the calibrator printed the report. (This is not the date and time of calibration.)
②	The user report string contents. (Set by the remote RPT_STR command.)
③	<p>The type of calibration report: Output Calibration or Calibration Check.</p> <ul style="list-style-type: none"> <li>• An Output Calibration Report, which can be requested at any time, shows offset and gain adjustments performed at the last calibration. The report is derived from two sets of calibration constants stored in non-volatile memory: the active set, and the set that was previously active. This calibration report is always based on external standards.</li> <li>• A Calibration Check Report shows recommended calibration adjustments that will never be stored. The report can be one of two forms, depending on when it's requested:</li> </ul> <p>The first form of this report is generated if you request the report immediately after calibration, before any adjustments have been stored. This lets you determine whether to implement the recommended adjustments. If only minor adjustments are recommended, you may decide to simply file the report and leave the rear panel Calibration Switch in its Normal position. This report includes calibration drift information on the calibrator's internal check standards, based on the applicable external artifacts standards.</p> <p>The second form of this report can be requested at any time other than immediately after calibration. This type of report shows calibrator drift relative to internal check standards, based on data from a just-completed calibration check. This report is based on externally calibrated internal check standards rather than actual data; a fact that is stated in the report.</p> <p>All calibration check data remains in memory and is available for reporting until replaced by a later calibration check or calibration, or until the calibrator is reset (or the power is cycled).</p>
④	The three characters that follow "Software Revision" provide the firmware versions for the Main CPU, the Inguard CPU, and the Boost CPU. Each version is separated by a plus (+). If no amplifier is attached then its position (third character) contains an asterisk (*).
⑤	A list of each analog module installed in the calibrator and the external amplifiers attached to the instrument and powered on.-
⑥	<p>The date and reported temperature of the most recent calibration. This always refers to the calibration that established the set of cal constants presently in use (stored in EEPROM).</p> <p style="text-align: center;"><i>Note</i></p> <p><i>A calibration check reports contain a line that shows the date and temperature of the calibration check, which refers to the calibration that established the set of constants presently in temporary memory. This line is indicated by (CalCheck) and can also refer to constants established by performing output calibration but not yet saved into EEPROM.</i></p>
⑦	The date and temperature of the previous calibration, prior to the most recent one.
⑧	The number of days between the day the calibration report was printed (#2 above) and the day that the presently active set of cal constants was stored into EEPROM (#5 above).
⑨	These numbers are the entered values of the external reference. They will only appear on calibration reports done on instruments with rev E or higher software. Otherwise, they will be blank lines.
⑩	The Resistance Reference is the average of the actual-to-nominal ratios of the 100Ω, 190 Ω, 1 k Ω, 1.9 k Ω, 10 k Ω, 19 k Ω, 100 k Ω, and 190 k Ω resistors. Prior to revision H, this line showed the calibrated value of the internal 10 k Ω reference resistor. As of revision H, the line is changed as shown in the report.

**Table 6-2. Annotation for Shift Results Printout (continued)**

<p>⑪</p>	<p>The values of each internal reference as established during the most recent calibration. The unit for each value is the same as listed in the reference name, just to the left under the REFERENCE heading.</p>
<p>⑫</p>	<p>The previous value of each internal reference. For a 5720 calibration check, this column is labeled Most Recent and refers to the active constants stored in EEPROM.</p>
<p>⑬</p>	<p>The reference shift expressed in parts per million (ppm). The formula used for this calculation is:  <math>1,000,000 \times (\text{Most Recent} - \text{Previous}) / (\text{Previous}) = \text{shift (ppm)}</math>                  For 5720 calibration check, the formula is:  <math>1,000,000 \times (\text{Cal check} - \text{Most Recent}) / (\text{Most Recent}) = \text{shift (ppm)}</math>                  The remaining pages in the calibration report give information which describe how the output has changed between the time two different calibration activities were performed. (See #1.) The calibrator checks each range at multiple points, as described further on.</p>
<p>⑭</p>	<p>This is the name of the range to which the shift information pertains.</p>
<p>⑮</p>	<p>The calibrator calculates shift information at multiple points, depending on the range and mode (dc V, ac V, etc.). Each line in the report for a given range contains shift information for a particular point. The "Point" column indicates which point in the range the data is calculated for.                  On this example page of dc voltage output shifts, two points are listed for each range, +FS and -FS. +FS refers to the positive full-scale value of the range, as given in the RANGE column. -FS refers to the negative full-scale value for the range. For the 220 mV range, +FS means +220 mV dc and -FS means -220 mV dc. These points are used to calculate the amount of full scale shift, as discussed further on.</p>
<p>⑯</p>	<p>This column lists how much the zero output has shifted between calibration events (i.e., comparing the most recent with the previous calibration). Assuming the calibrator output was exactly 0V immediately after the previous calibration, the number listed in this column shows what the calibrator output was just before the most recent calibration was performed. There are two zero checks for each dc range, one for the portion of the range &gt;0V and one for the portion &lt;0V. The report includes the positive portion zero shifts in the +FS line and the negative portion zero shifts in the -FS line.                  For example, the positive portion zero of the 220 mV range shifted from 0.00000 mV to -0.00020 mV between the previous calibration and the most recent calibration. (Listed under the 220 mV range, +FS point.) If this calibration data is stored, all positive outputs on the 220 mV range will be increased by 0.00020 mV.</p>

Table 6-2. Annotation for Shift Results Printout (continued)

<p>17</p>	<p>As with zero shifts, the calibrator calculates how much the full scale point has shifted between the two calibrations. This is listed in two columns under the “Full Scale Shift” heading. The left column under this heading indicates how much the output shifted expressed in the units of output for the range. For example, the +FS point on the 220 mV range shifted from 220.00000 mV to 199.99915 mV between the previous calibration and the most recent calibration. (<math>220.00000 - 0.00085 = 199.99915</math>)</p> <p>The right column under the “Full Scale Shift” heading gives the shift expressed in parts per million (ppm). The formula used is:</p> $\text{shift} = 1,000,000 \times (\text{full scale shift} / \text{full scale range point})$ <p>For example, if the full scale shift is -0.00085 mV on the +FS point of the 220 mV range,</p> $\text{shift} = 1,000,000 \times (-0.00085 \text{ mV} / +220 \text{ mV}) = -3.86 \text{ ppm.}$ <p>Note that this is shown as -3.87 ppm in the sample printout. The 0.01 ppm difference is due to rounding error caused by the limited resolution used in the calculation. The calibrator uses much greater resolution for internal calculations.</p> <p>Full scale shift includes all sources of shift at the full scale point that is checked, including both gain and zero shift components. To determine the gain component of the full scale shift, subtract the number in the zero shift column from the number in the left Full Scale Shift column.</p> <p>e.g., for the -FS point on the 220 mV range:</p> $\begin{aligned} \text{total shift} &= +0.00047 \text{ mV (left column under Full Scale Shift)} \\ \text{zero shift component} &= -0.00017 \text{ mV (Zero Shift column)} \\ \text{gain shift component} &= +0.00064 \text{ mV (subtract zero shift from total shift)} \end{aligned}$
<p>18</p>	<p>This column shows calibrator uncertainty at the full-scale point being checked, using the calibration interval specified in the setup menu. (e.g., the total specified uncertainty at 2.2V is 6.55 ppm.)</p>
<p>19</p>	<p>The last column expresses full-scale shift as a percentage of specification. The formula is:</p> $\text{shift (\% spec)} = 100 \times (\text{full scale shift} / \text{spec (+/-)})$ <p>Using the 220 mV range example, full-scale shift is -3.87 ppm, and the specification is 10.41 ppm:</p> $\text{shift} = 100 \times (-3.87 \text{ ppm} / 10.41 \text{ ppm}) = -37.18\% \text{ of spec.}$
<p>20</p>	<p>For ac outputs, the column under the “Point” heading means something slightly different than those for dc outputs:</p> <p>FS means the calibrator calculates shift at the full scale point for a low frequency where flatness correction constants are not applied. This is the shift as a result of changes in range gain constants. (There is no zero shift component for an ac output.) When calculating uncertainty, the calibrator uses the full-scale magnitude at a frequency of 1 kHz.</p> <p>For example, the FS point on the 2.2 mV ac range at low frequencies shifted from 2.200000 mV to 2.199982 mV between the previous calibration and just before the most recent calibration. (<math>2.200000 - 0.000018 = 2.199982</math>)</p> <p>When the point describes a frequency, the shift in output is calculated at that frequency. This shift shows the effect of changes in output due to flatness correction. The instrument calculates the uncertainty (Spec +/-) column) using the full scale point and the frequency listed under the Point column.</p> <p>For example, the 50.00 kHz point on the 2.2 mV ac range shifted from 2.200000 mV to 2.199983 mV between the previous and the most recent calibration. (<math>2.200000 - 0.000017 = 2.199983</math>)</p>

# **Chapter 7**

## **Operator Maintenance**

	<b>Title</b>	<b>Page</b>
7-1.	Introduction.....	7-3
7-2.	Accessing the Fuse.....	7-4
7-3.	Cleaning the Air Filter .....	7-4
7-4.	Cleaning the Exterior .....	7-6
7-5.	Calibration .....	7-6
7-6.	Calibrating the 5700A/5720A Series II to External Standards .....	7-6
7-7.	Calibration Requirements .....	7-7
7-8.	When to Adjust the Calibrator’s Uncertainty .....	7-7
7-9.	Calibration Procedure .....	7-8
7-10.	Range Calibration .....	7-14
7-11.	Calibrating the Wideband AC Module (Option 5700A-03) .....	7-18
7-12.	Performing a Calibration Check .....	7-21



## **7-1. Introduction**

This chapter explains how to perform the routine maintenance and calibration tasks required to keep your calibrator in optimal operating condition. The tasks covered in this chapter include the following.

- Replacing the fuse
- Cleaning the air filter and external surfaces
- Calibrating to external standards
- Calibrating the range
- Calibrating the wideband ac module
- Checking the calibration

For intensive maintenance tasks such as troubleshooting or repair, and for all procedures that require opening the cover of the instrument, refer to the *5700A/5720A Series II Service Manual*. The service manual contains complete verification procedures for checking that traceability to national standards is being maintained by the normal calibration procedure.

## 7-2. Accessing the Fuse

The fuse is accessible from the rear panel. The fuse rating label to the right of the fuse holder shows the correct replacement fuse ratings for each operating voltage. To access the fuse, refer to Figure 7-1 and proceed as follows:

1. Disconnect line power.
2. Using a standard screwdriver, turn the fuse holder counterclockwise until the cap and fuse are disengaged.

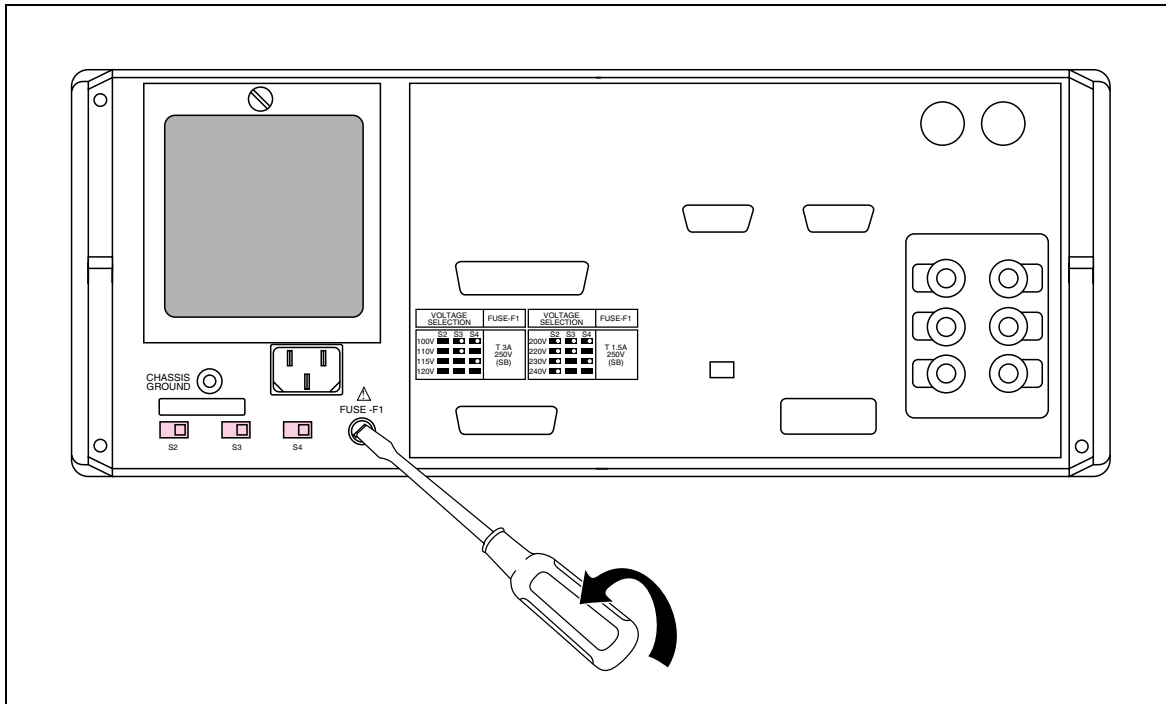


Figure 7-1. Accessing the Fuse

## 7-3. Cleaning the Air Filter

### Caution

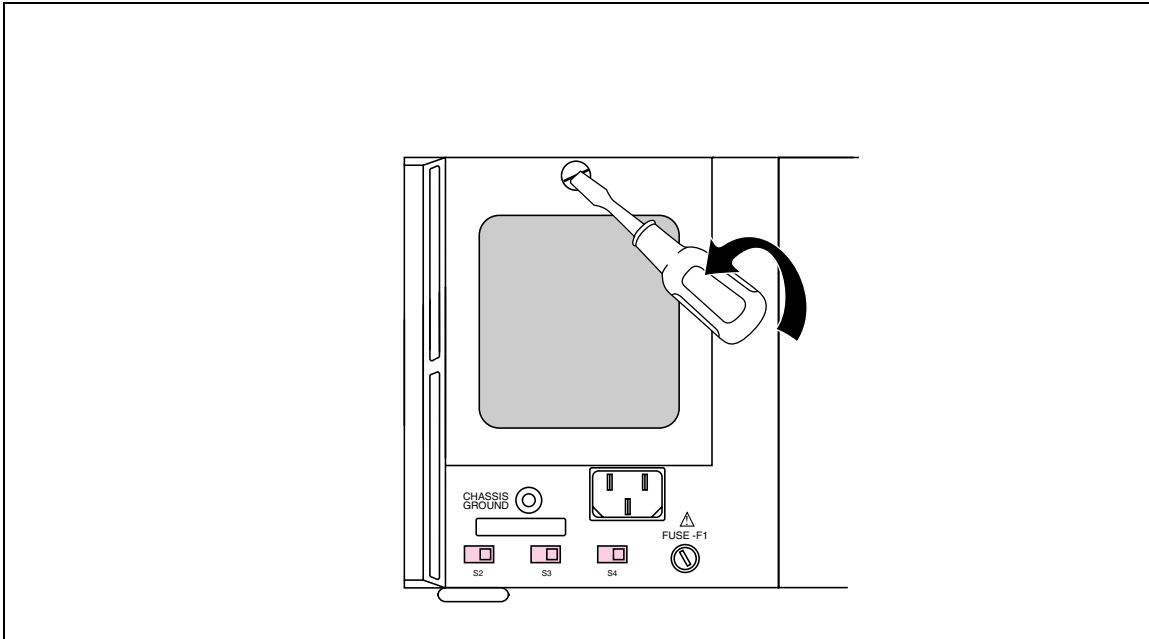
**Damage caused by overheating may occur if the area around the fan is restricted, the intake air is too warm, or the air filter becomes clogged.**

The air filter must be removed and cleaned at least every 30 days, or more frequently if the calibrator is operated in a dusty environment. The air filter is accessible from the rear panel of the calibrator.

To clean the air filter, refer to Figure 7-2 and proceed as follows:

1. Disconnect line power.
2. Remove the filter by unscrewing the knurled screw at the top of the air filter pulling the filter's retainer downwards (it hinges at the bottom) and removing the filter element.
3. Clean the filter by washing it in soapy water. Rinse and dry it thoroughly before reinstalling.

4. Reinstall the filter and the knurled screw.



**Figure 7-2. Accessing the Air Filter**

## **7-4. Cleaning the Exterior**

To keep the calibrator looking like new, clean the case, front panel keys, and lens using a soft cloth slightly dampened with either water or a non-abrasive mild cleaning solution that is not harmful to plastics.

### **Caution**

**Do not use aromatic hydrocarbons or chlorinated solvents for cleaning. They can damage the plastic materials used in the calibrator.**

## **7-5. Calibration**

This chapter provides procedures for calibrating the 5700A/5720A Series II to external standards, adjusting the range if necessary, and for performing a calibration check.

Your calibrator is calibrated at the factory with constants that are traceable to the U.S. National Bureau of Standards. In order to maintain traceability, you only need to met the following requirements.

- Calibration to external standards must be completed at the beginning of the calibration cycle
- Performance verification must be completed every two years. (See the *5700A/5720A Series II Service Manual* for procedures.)

Calibration check and range calibration are optional procedures that are provided for enhancing the accuracy if needed for special requirements.

For a description of the calibration process and the theory behind its use to establish traceability to national standards, see Chapter 1 of this manual. Included in this chapter is a description of the calibration check feature, and how it can be used to develop a performance history for the calibrator. Detailed calibration theory can be found in the *5700A/5720A Series II Service Manual*.

## **7-6. Calibrating the 5700A/5720A Series II to External Standards**

You must calibrate to external standards at the beginning of the calibration cycle. The length of the cycle (24 hours, 90 days, 180 days, or one year) is selected in a setup menu described in Chapter 4.

To calibrate the 5700A/5720A Series II, you apply three portable standards to the output binding posts: a 10V dc voltage standard, a 1 $\Omega$  resistance standard, and a 10 k $\Omega$  resistance standard. The following standards are recommended:

- Model 732A or 732B DC Reference Standard
- Model 742A-1 1 $\Omega$  Resistance Standard
- Model 742A-10k 10 $\Omega$  Resistance Standard

Use the following Low Thermal Leads for all connections:

- When calibrating the 5700A, use either the connector set 5440A-7002 (banana plugs) or the set 5440A-7003 (spade lugs).
- When calibrating the 5720A, use the set 5440A-7003 (spade lugs).

**7-7. Calibration Requirements**

Both the calibrator and the recommended external standards have the ability to internally control (or compensate for) ambient temperature variations. Therefore it is unnecessary to keep the calibrator in tightly controlled temperatures during calibration. During the calibration procedure, the calibrator prompts you to enter the ambient temperature, and includes this information in specification readouts and output shift reports.

**7-8. When to Adjust the Calibrator’s Uncertainty**

Table 7-1 lists each external standard’s uncertainty limit, and the 5700A/5720A Series II uncertainty specifications that must adjusted accordingly if that limit is exceeded.

As long as the external standards have the uncertainties listed in Table 7-1, you do not need to adjust the calibrator’s absolute uncertainty specifications in Chapter 1. However, if your standard’s uncertainty exceeds the value in the table you must adjust some of the calibrator’s absolute uncertainty specifications by the algebraic difference between your standard’s uncertainty and the uncertainty limit listed in the Table 7-1. For example, if the dc voltage standard has an uncertainty of  $\pm 2.5$  ppm, then the 5700A and the 5720A absolute uncertainty specifications listed in Table 7-1 must all be increased by  $\pm 1$  ppm.

**Table 7-1. Standards for Calibrating 5700A/5720A Series II**

<b>Fluke Standard</b>	<b>Traceable Quantity</b>	<b>Nominal Value</b>	<b>Uncertainty Limit</b>	<b>5700A/5720A Series II Specifications susceptible to Uncertainty Limit</b>
732B	Voltage	10V	$\pm 1.5$ ppm	dc volts, ac volts, dc current, ac current
742A-1	Resistance	1 $\Omega$	$\pm 10$ ppm	1 $\Omega$ , 1.9 $\Omega$
742A-10k	Resistance	10 k $\Omega$	$\pm 4$ ppm	ac current, dc current 10 $\Omega$ to 100 M $\Omega$

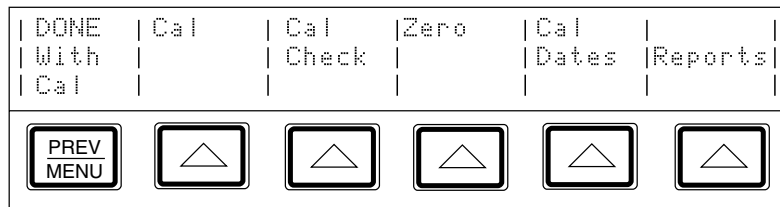
### 7-9. Calibration Procedure

Before you begin this procedure make sure the calibrator is powered on and has completed the appropriate warm-up period.

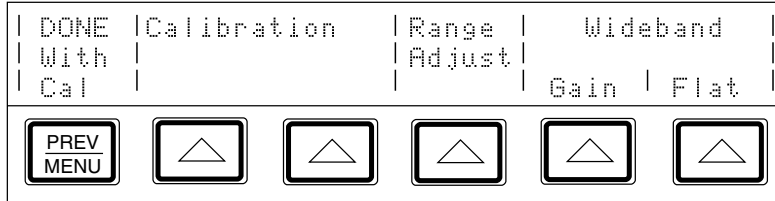
After you have finished calibration, but before you save the new constants, the calibrator presents the new changes as  $\pm$  ppm, and as a percentage of specifications for each range and function. A list of changes can be sent to a computer through either the serial or instrument control (IEEE-488) port, or printed through the serial port. The largest proposed change will be displayed on the calibrator's front panel.

Follow this procedure to calibrate the main output functions.

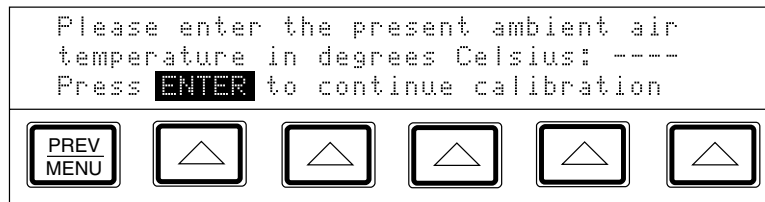
1. Press the "Setup Menus" softkey; then press the "Cal" softkey. The calibration menu appears as shown below:



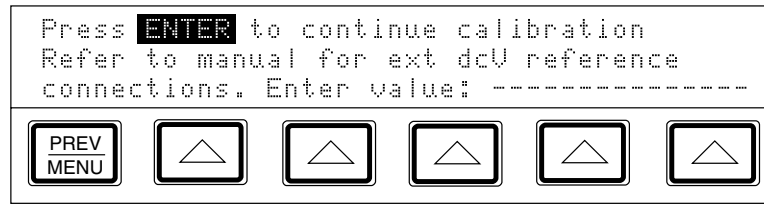
2. Press the "Cal" softkey. The display shows the following.



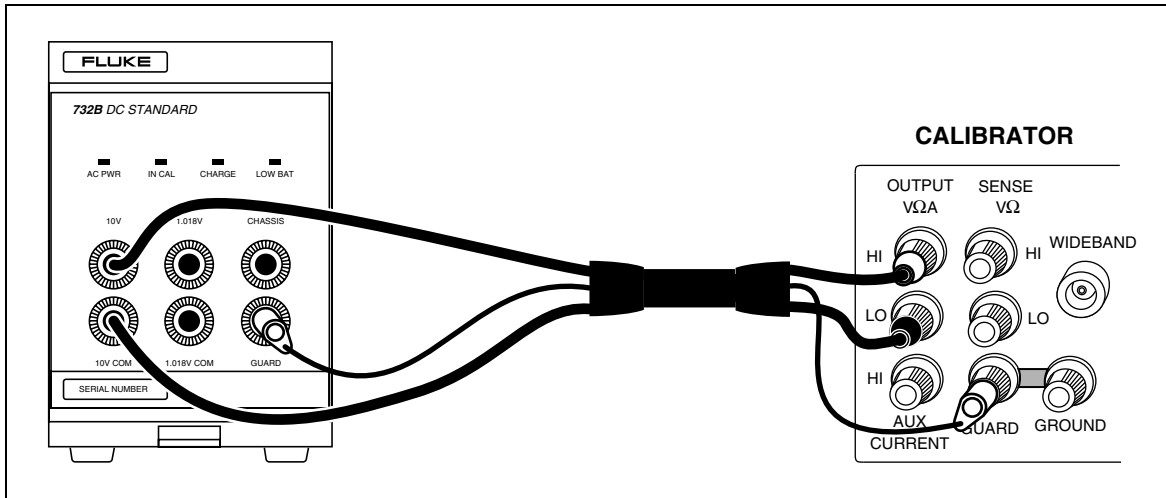
2. To calibrate the main output functions, press one of the softkeys under "Calibration." The display shows the following:



3. Enter the ambient temperature; then press  . The display shows:



4. Connect the 732B to the calibrator as shown in Figure 7-3.



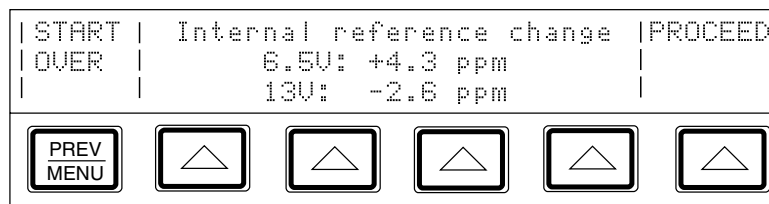
**Figure 7-3. 732B External Calibration Connections.**

6. Enter the true value of the 732B 10V output. The true value is the value printed on the calibration sticker, plus or minus, as well as drift that has occurred since calibration. That drift can be estimated provided control charts have been maintained for the 732B.

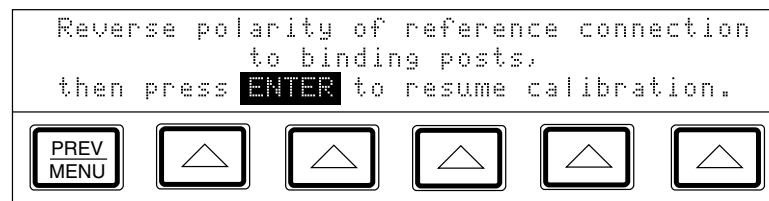
If the entered value is not between 9V and 11V, and error message appears, which lets you start over from this point with a calibrated 732B. Press **ENTER**, and the display shows the following:



When the calibrator's 6.5V and 13V references have been characterized, the display shows the following message, which lets you accept or reject the changes that are about to be made to the calibration constants.



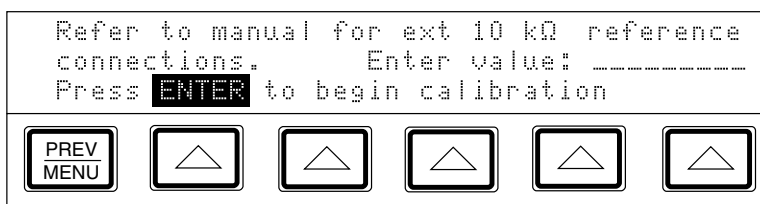
7. To reject the changes, return to the calibration menu shown in step 2 by pressing **PREV MENU**. Otherwise, press the softkey under "Proceed" to accept and save the changes, and to open the display shown below, letting you continue with calibration.



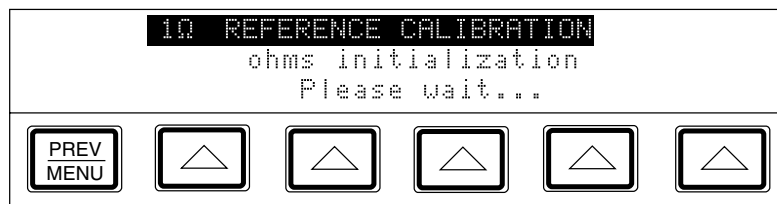
8. Reverse the HI and LO connections at the 732B terminals, and press . The following displays appear, asking you to wait before proceeding with the 10 kΩ standard.



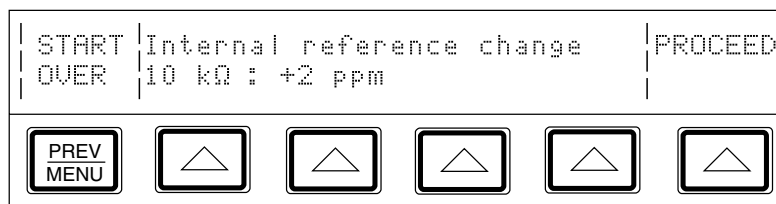
After a few seconds, the following display appears:



9. Connect the calibrator to the 10 kΩ standard as shown in Figure 7-4 and enter the true value of the standard. If the standard is not between 9 kΩ and 11 kΩ, an error message appears, which allows you to start over from this point with a different standard. Press  again to open the following display:



When the internal 10 kΩ reference has been characterized, the following message appears, which lets you accept or reject the changes that are about to be made to the calibration constant:



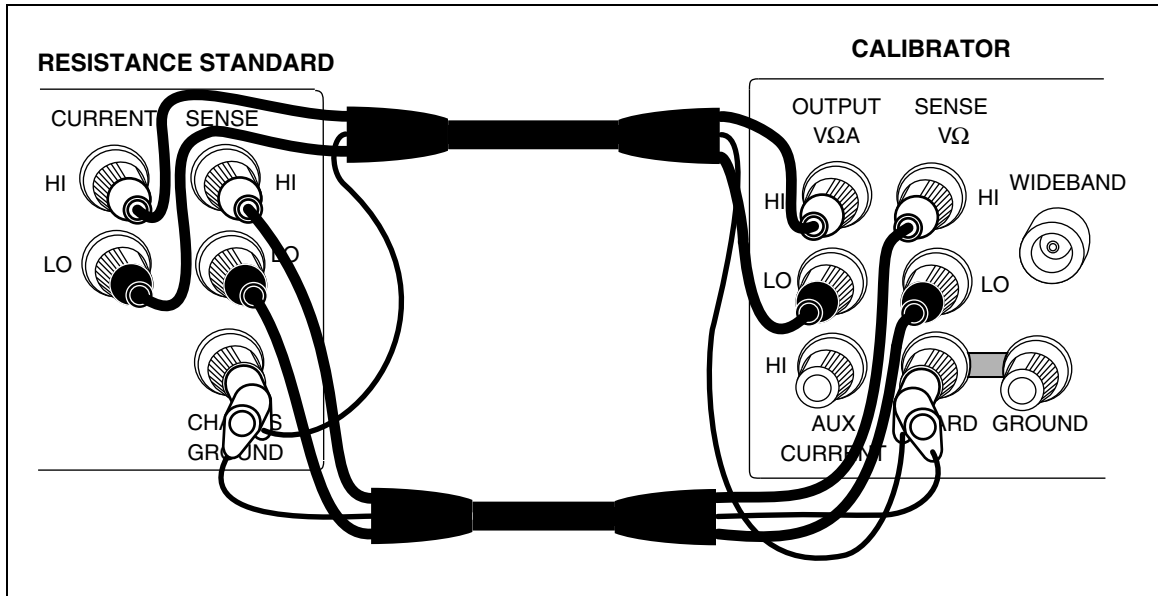
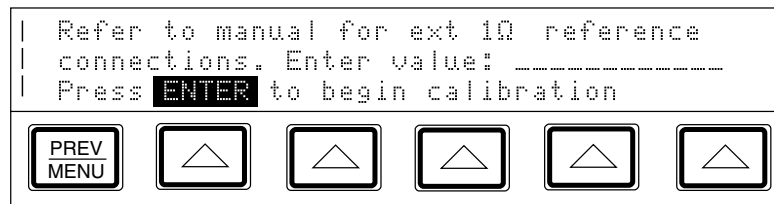
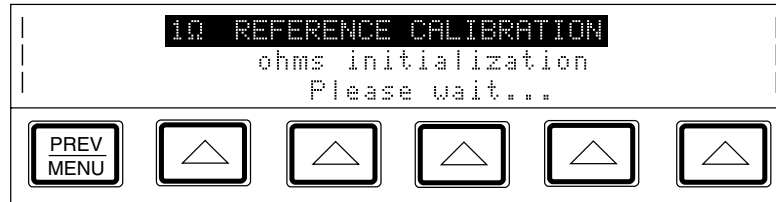


Figure 7-4. 742A-1 and 742A-10k External Calibration Connections

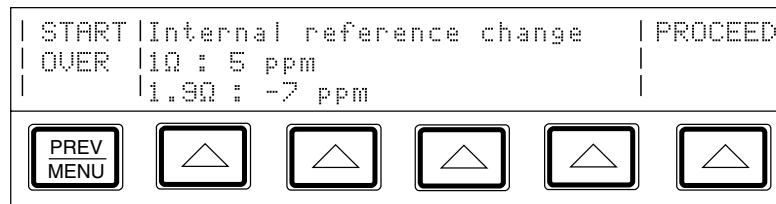
- To reject the changes, return to the calibration menu shown in step 2 by pressing **PREV MENU**. Otherwise, press the softkey under “Proceed” to accept and save the changes, and to open the display shown below, letting you continue with calibration.



- Disconnect the 10 kΩ standard, and connect the calibrator to the 1Ω standard; then enter the true value of the 1Ω standard. If the standard is not between 0.9Ω and 1.1Ω, an error message appears, which lets you start over from this point with another standard. Press  to bring up the following display:



When the internal 1Ω reference has been characterized, the following message appears, which lets you accept or reject the changes that re about to be made to the calibration constant:



- To reject the changes, return to the calibration menu shown in step 2 by pressing . Otherwise, press the softkey under “Proceed” to accept and save the changes, and let the calibrator complete the internal calibration steps.
- The calibration is not effective until you store the newly calibrated constants in memory. To store the constants, set the rear panel CALIBRATION switch to ENABLE, the press the “Store Values” softkey.

*Note*

*To review the proposed output shifts before you store the new constants, print a listing of the proposed shifts by pressing the softkey under “Print Output Shifts.”*

- After you store the constants, press the softkey under “DONE with Cal” to exit calibration and resume normal operation.
- If you press this softkey before you store the constants, the new constants will be used temporarily for normal operation until the calibrator is powered down or reset. (This is only true for software versions G and lower. For versions H and higher, the process is aborted without updating existing constants.)
- Set the rear panel CALIBRATION switch to NORMAL.

## 7-10. Range Calibration

Once calibration is complete, you may find you need to make further adjustments to the range. Calibrating the range is accomplished by adjusting a range constant, which is an additional gain multiplier. Although range calibration is not needed in order to meet total uncertainty specifications, they are useful for tuning the calibrator so that its values are closer to your own standards.

Use your own laboratory standard to adjust the range constants. The following procedure for adjusting the range constants is designed for laboratory standard values that are: between 45% and 95% of the range's full-scale value.

Once you adjust the range constant, the new constant remains active until the next calibration, at which time all range constant multipliers are reset to 1. You can also erase all range adjustments by calling up the format EEPROM menu and selecting Range Constants (see Chapter 4).

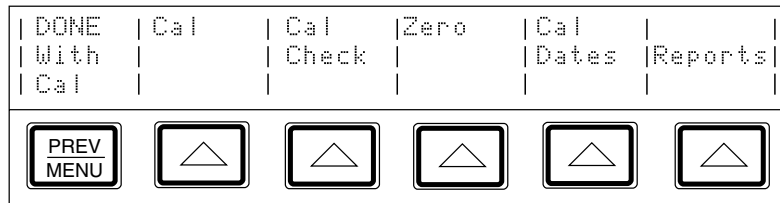
Before you begin the following procedure, make sure you have the equipment you need on hand including your own laboratory standards where required.

The following example procedure adjusts the 220V dc range constant using the following equipment:

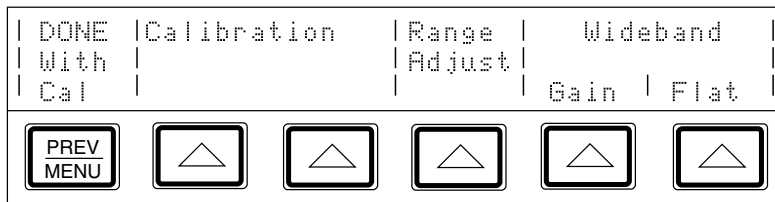
- 732B DC reference standard
- 752A Reference Divider
- 845AB/845AR Null Detector
- Low Thermal Test Leads: 5440A-7002 (banana plugs) or 5440A-7003 (spade lugs)

Proceed as follows to adjust the 220V dc range constant. You must have completed calibration to external standards before you follow this procedure.

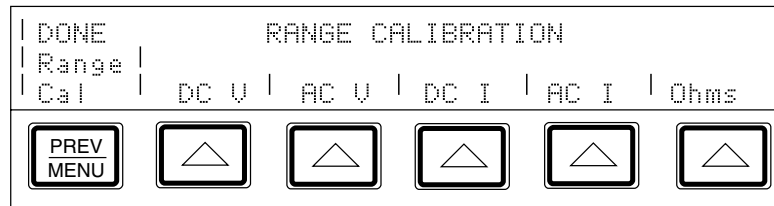
1. Press the "Setup Menus" softkey; the press the "Cal" softkey. The following menu appears:



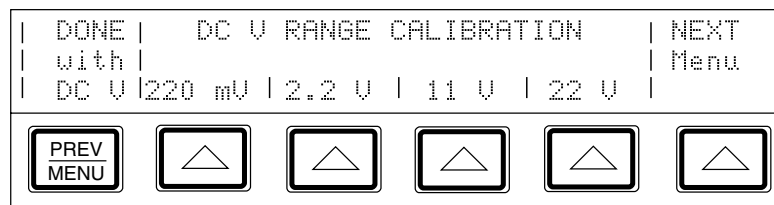
2. Press the "Cal" softkey to bring up the next menu shown below:



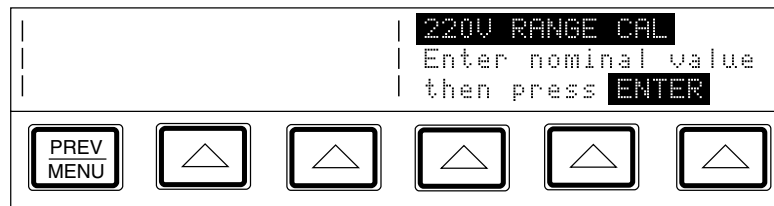
- Press the “Range Adjust” softkey to bring up the next menu shown below:



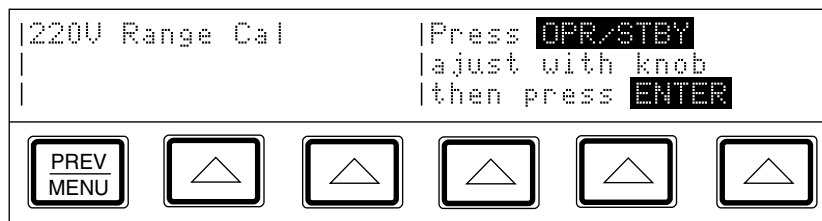
- Press the “DC V” softkey to bring up the next menu shown below:



- Press the “NEXT Menu” softkey, which scrolls through all the available dc voltage ranges, until 220V appears. Then press that selection’s softkey to open a display similar to the following:



- Connect the 732B, 845A, and 732B in a 10:1 configuration, as shown in Figure 7-5.
- Multiply the 732B’s value by 10, and enter this new value. (This value is the output of the 752A, to which you will null the calibrator’s output.) Then press  to bring up the following display.



8. Press  to activate the calibrator output. Then turn the output adjustment knob on the calibrator until you achieve a null on the 845A Null Detector.
9. Set the rear panel CALIBRATION switch to ENABLE. Press  on the front panel. The calibrator will now calculate a new range constant multiplier for the 220V dc range, and will store it in non-volatile memory.
10. The range calibration is now complete. Set the rear panel CALIBRATION switch to the NORMAL position, disconnect the external standards, and press  to reset the calibrator to its newly calibrated ranges.

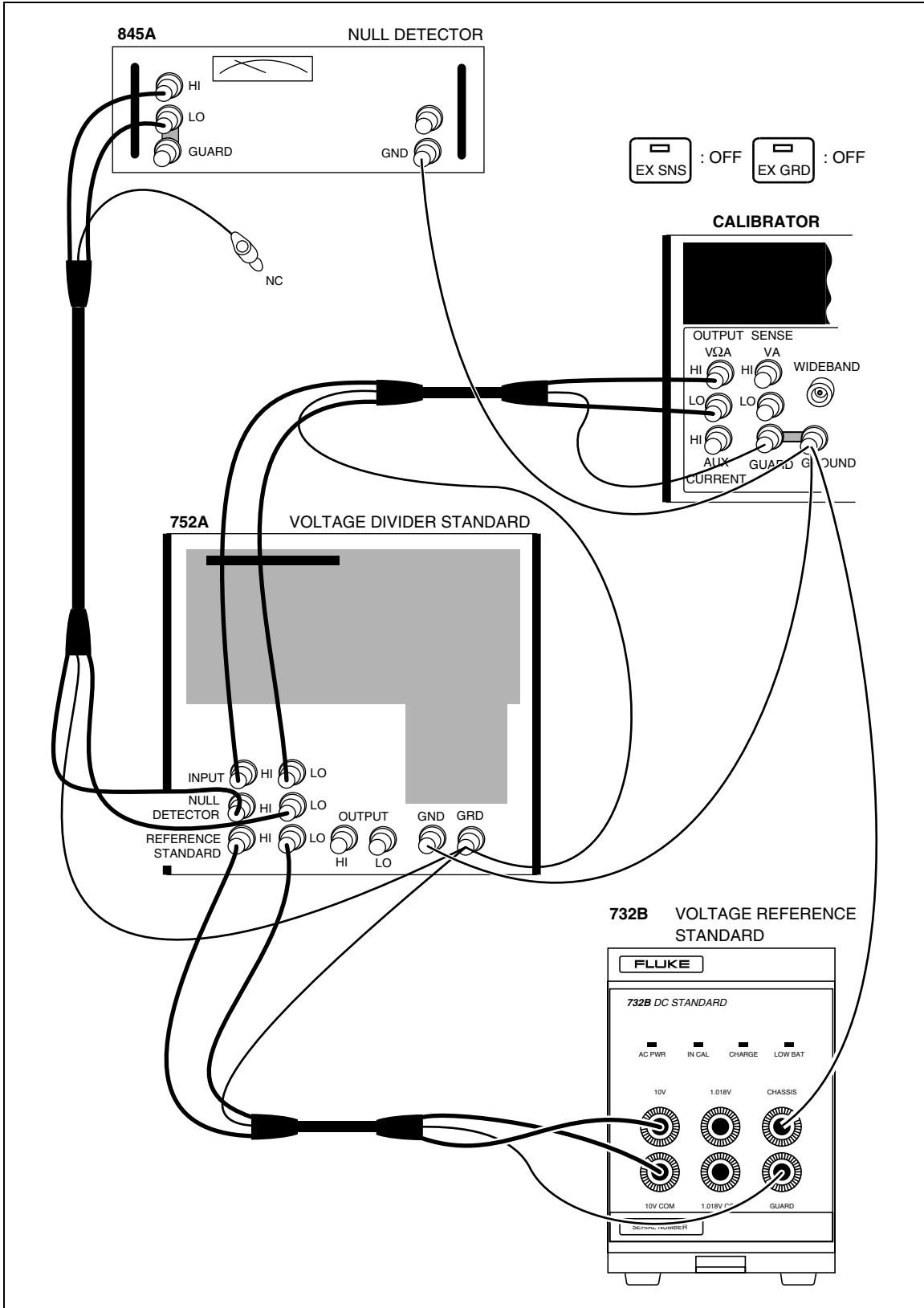


Figure 7-5. 220V DC Range Calibration Connections

### 7-11. Calibrating the Wideband AC Module (Option 5700A-03)

The Wideband AC Module (Option 5700A-03) can be installed in either the 5720A or 5700A Series II Calibrator. The module needs to be calibrated for both gain and flatness. The gain should be calibrated when the 5700A-03 main output functions undergo their routine calibration.

Since frequency flatness is determined by stable parameters (i.e. circuit geometry and dielectric constants), the flatness of the Wideband AC Module has excellent long-term stability. Consequently, a two-year calibration cycle is adequate for flatness calibration, and can be scheduled to coincide with the calibrator’s shipment to a standards laboratory for periodic verification.

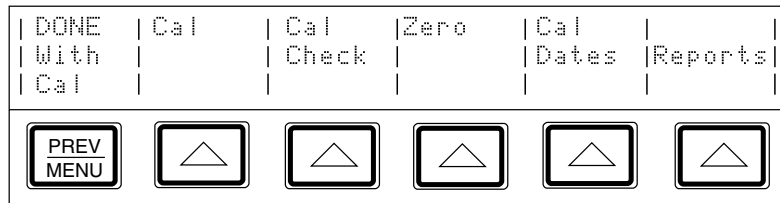
The following procedure describes how to perform the wideband gain calibration. The procedure for performing the wideband flatness calibration can be found in the 5700A/5720A Series II Service Manual.

*Note*

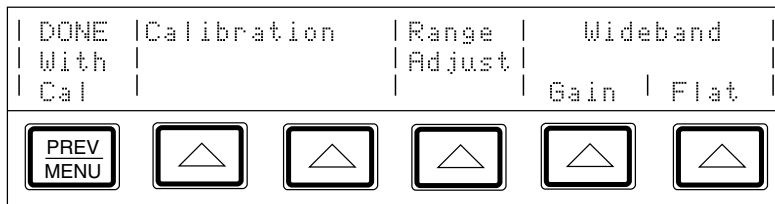
*To perform this procedure you will need, in addition to the standard equipment supplied with the wideband option, a Type “N” female to double banana plug adapter (e.g., Pomona 1740).*

Before you start this procedure, make sure the calibrator is powered on and has completed an appropriate warm-up period. The proceed with this procedure to calibrate the wideband gain.

1. Press the “Setup Menus” softkey; then press the “Cal” softkey to bring up the menu shown below:

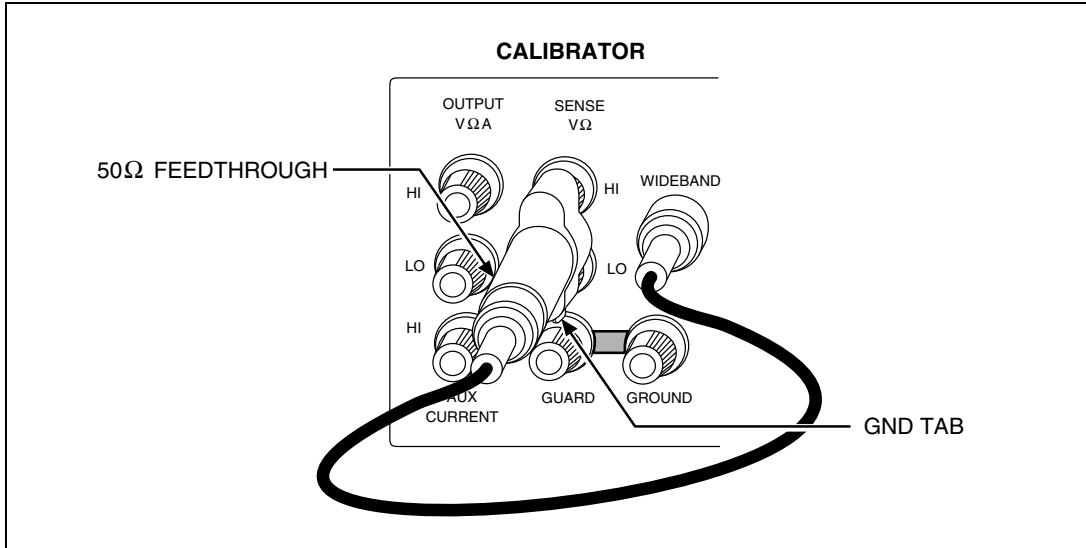


2. Press the “Cal “ softkey to bring up the following menu:



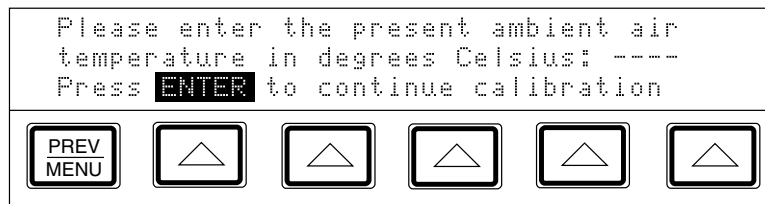
3. Connect the wideband output cable between the WIDEBAND connector and the SENSE binding post.

The center conductor of the 50Ω feedthrough should go to SENSE HI and shown in Figure 7-6. The GND tab on the adapter should be on the LO side.

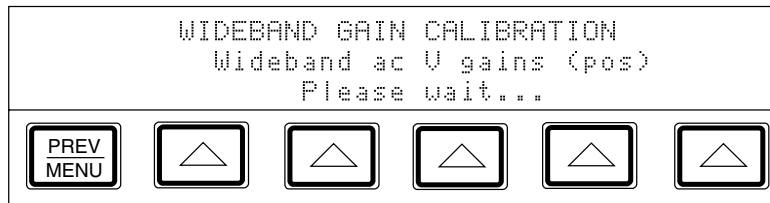


**Figure 7-6. Wideband Module Calibration Connection**

4. Press the “Gain” softkey to bring up the following display:

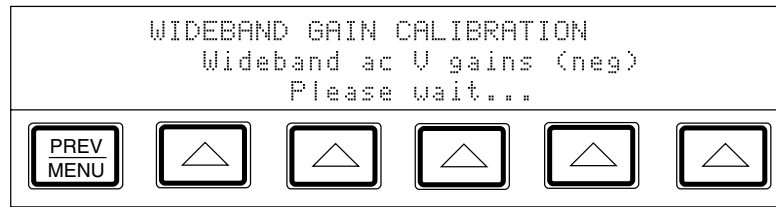


5. Enter the ambient temperature; the press . The display shows the following:



As the wideband calibration proceeds, messages appear on the display identifying all processes as they are encountered. When positive gains calibration is complete, a message appears telling you to refer to the manual for negative gains connections.

- Reverse the dual-banana connector so that the center connector is connected to LO; then press . The display shows the following:



- After a short time, a message appears indicating that the wideband calibration is complete.
- To store the new constants, set the CALIBRATION switch to ENABLE and press "Store Values." To discard the constants, press "DONE with Cal" and answer "YES" when the display asks for verification.
  - You have now completed the wideband gain calibration. Set the CALIBRATION switch to NORMAL, disconnect the wideband cable, and press .

## 7-12. Performing a Calibration Check

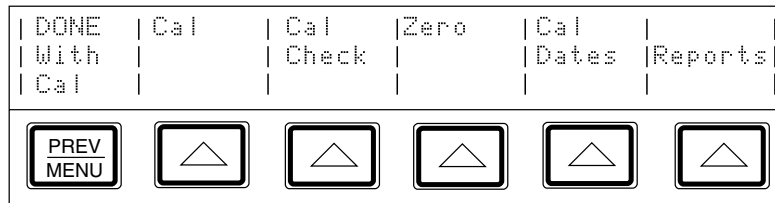
A calibration check is similar to the calibration, with the primary difference being that no changes are made to the stored constants, and the internal check standards are used as the reference points. A calibration check produces a report similar to the normal calibration report, and shows any proposed changes.

This procedure can be performed from an external computer, and can be set to run automatically, with no assistance (there is no need to enable the CALIBRATION switch, since no constants are changed).

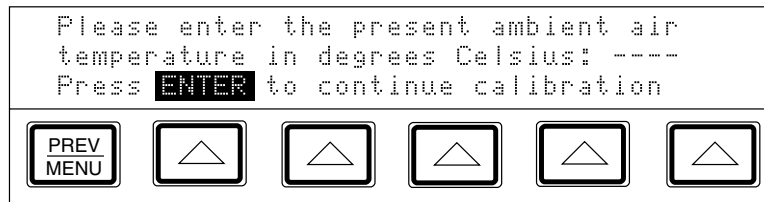
You can use the calibration check at any time to confirm the integrity of the calibrator without connecting external standards. The calibration check is also useful for collecting a performance history.

Before you begin this procedure, make sure the calibrator is powered on and has completed the appropriate warm-up period. Then follow this procedure to check the calibration.

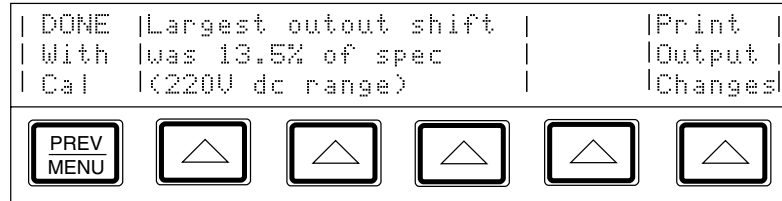
1. Press the “Setup Menu” softkey; then press the “Cal” softkey to bring up the following menu:



2. Press the “Cal Check” softkey to bring up the following display:



3. Enter the ambient temperature; then press . As the calibration check proceeds, the display indicates the current process of the calibration check. When the check is complete, the largest shift that is detected appears on the display.



4. You can now print a list of the proposed shifts, or quit without creating a list.  
To print the report, connect a printer and set up the serial interface as described in Chapter 6. Press the softkey under “Print Output Changes.” To return to normal operation without printing, press the softkey under “DONE with check.”
5. Press  to exit the calibration menus.

## **Chapter 8**

# **Options and Accessories**

	<b>Title</b>	<b>Page</b>
8-1.	Introduction.....	8-3
8-2.	Wideband AC Voltage Module (Option 5700A-03).....	8-3
8-3.	Accessories .....	8-3
8-4.	Low Thermal EMF Test Leads.....	8-4
8-5.	Rack Mount Kits (Y5737 and Y5735) .....	8-4
8-6.	Shielded IEEE-488 Interface Cables (Y8021, Y8022, and Y8023) .	8-4
8-7.	RS-232C Null-Modem Cables (Y1702 and Y1703) .....	8-4
8-8.	DC Voltage Reference Standard (732B) .....	8-4
8-9.	1 $\Omega$ and 10 k $\Omega$ Resistance Standards (742A-1 and 742A-10k).....	8-5
8-10.	5725A Amplifier.....	8-5



## 8-1. Introduction

This chapter describes options and accessories available to enhance the capabilities of the 5700A/5720A Series II Calibrator. Chapter 4 contains instructions for operating the calibrator with the options and accessories described here. To order options or accessories, call or write to a Fluke Service Center.

## 8-2. Wideband AC Voltage Module (Option 5700A-03)

The Wideband AC Voltage Module (Option 5700A-03) is used to calibrate RF voltmeters, and can be installed in either a 5720A or 5700A Series II calibrator. Its frequency ranges from 10 Hz to 30 MHz, and is a highly accurate, low-noise, ac voltage source that maintains excellent flatness. The module sources its output through a coaxial connector into a 50 $\Omega$  load, and this output can be from within any of seven ranges of values, from 300  $\mu$ V (-57 dBm) to 3.5V (+24 dBm), selected in either volts or dBm.

The wideband module also functions with the calibrator's edit controls, allowing you to display the error of a wideband meter in percentage of output or decibels.

## 8-3. Accessories

Included with the wideband module are a Type "N" output cable and a 50 $\Omega$  terminator. The wideband module is calibrated to the end of its standard equipment output cable.

Table 8-1 summarizes the accessories available for the 5700A/5720A Series II Calibrator. Following the table is a brief description of each accessory.

**Table 8-1. Accessories**

Model	Description
732B	DC Voltage Reference Standard
742A-1	1 $\Omega$ Resistance Transfer Standard
742A-10k	10 k $\Omega$ Resistance Transfer Standard
5440A-7002	Low Thermal EMF Test Lead Set with Banana Plugs: One 4 ft. cable (122 cm) and two 2 ft. (61 cm) cables.
5440A-7003	Low Thermal EMF Test Lead Set with Spade Lugs. Two 4 ft. (122 cm) cables and One 2 ft. (61 cm) cable.
Y8021	IEEE-488 Shielded Interface Cable, 1 Meter
Y8022	IEEE-488 Shielded Interface Cable, 2 Meters
Y5737	24 in (61 cm) Rack Mount Kit for 5700A/5720A Series II
Y5735	24 in (61 cm) Rack Mount Kit for 5725A
PAC33	Printer Adapter Cable, Serial to Parallel Interface

#### **8-4. Low Thermal EMF Test Leads**

Two types of low thermal test leads are available. These cables are designed to exhibit low thermal emfs. The types available are:

- Model 5440A-7002. Low Thermal Test Lead cables with banana plugs.  
Set includes one 4 ft. (122 cm) cable and two 2 ft. (61 cm) cables. Each cable includes two conductors and a shield lead.
- Model 5440A-7003. Low Thermal Test Lead cables with spade lugs.  
Set includes two 4 ft. (122 cm) cables and One 2 ft. (61 cm) cable. Each cable includes two conductors and a shield lead. Shield lead has a banana plug connector.

#### **8-5. Rack Mount Kits (Y5737 and Y5735)**

The rack mount kits provide all the hardware necessary to mount the calibrator and the 5725A Amplifier on slides in a 24-inch (61 cm) equipment rack. Model Y5737 is for the 5700A/5720A Series II and Model Y5735 is for the 5725A. Instructions are provided in Chapter 2 and are also included with each kit.

#### **8-6. Shielded IEEE-488 Interface Cables (Y8021 and Y8022)**

Shielded IEEE-488 cables are available in two lengths (see Table 8-1). The cables attach the calibrator to any other IEEE-488 device. Each cable has double 24-pin connectors at both ends to allow stacking. Metric threaded mounting screws are provided with each connector. Figure 5-2 in Chapter 5 shows the pinout for the IEEE-488 connector.

#### **8-7. RS-232C Null-Modem Cables**

An RS-232C Null-Modem Cable connects the calibrator to a printer, video-display terminal, computer, or other serial device configured as DTE (Data Terminal Equipment). Figure 6-1 in Chapter 6 shows the pinout for the rear-panel serial interface connector. (For parallel printers, use the PAC33 Printer Adapter Cable.)

Chapter 6 contains instructions for transferring serial data from the calibrator. Chapter 5 contains instructions for operating the calibrator remotely.

#### **8-8. DC Voltage Reference Standard (732B)**

The Fluke 732B is a rugged, easily transported solid state direct voltage reference standard with a highly predictable 10V output. This predictability allows the Fluke Standards Laboratory, as well as many Fluke customers, to completely eliminate fragile, saturated standard cells. Many laboratories that maintain standard cells use the 732B as a transportable voltage standard, eliminating the need to transport their standard cells. The 732B can be short circuited, even for extended periods of time, without damage or loss of stability. The 732B maintains full specified stability over a temperature span of 18 to 28°C.

The calibrator uses a 10V reference standard such as the Fluke 732B in an automated menu-prompted procedure to establish voltage traceability. Chapter 7 describes this procedure.

### **8-9. 1Ω and 10 kΩ Resistance Standards (742A-1 and 742A-10k)**

The 742A Series Standard Resistors are available in values of 1Ω and 10 kΩ to support 5700A/5720A Series II calibration. Constructed of arrays of Fluke wirewound precision resistors, these standards are ideally suited as support standards for the calibrator. Stability of the resistance transfer standards and their temperature coefficient make them ideal for easy transport to and operation in the calibrator's working environment.

The calibrator uses 1Ω and 10 kΩ resistor standards such as the 742A Series in its automated calibration procedure to establish external traceability. Chapter 7 describes this procedure.

### **8-10. 5725A Amplifier**

The 5725A is available to extend the high voltage performance and current range of the 5700A/5720A Series II Calibrator.

An interface connector on the calibrator rear panel accepts the cable to directly operate a 5725A. Once you have connected the amplifier and configured the calibrator in a setup menu, operation is controlled by the calibrator.

Chapter 4 provides instructions for operating the 5725A amplifier. The general specifications at the end of Chapter 1 include specifications for operating the calibrator with the 5725A. For other amplifier specifications, refer to their instruction manuals. Table 1-1 summarizes the extended capabilities offered by each amplifier. Brief descriptions of the extended capabilities follow.

The Fluke 5725A Amplifier is an external unit operating under calibrator control to extend ac voltage drive capabilities and both ac and dc current output range. The amplifier adds the following capabilities to the calibrator's 1100V ac range with no compromise in accuracy:

- Frequency limits at higher voltage increase to 100 kHz at 750V, 30 kHz at 1100V.
- Load limit increases to 70 mA for frequencies above 5 kHz.
- Capacitive drive increases to 1000 pF, subject to the maximum output current.

Extended-performance voltage is available at the calibrator's front or rear binding posts, eliminating the need to change cables during a procedure.

A separate set of binding posts on the front panel of the 5725A supplies extended-range ac and dc current outputs. Since most meters have a separate input terminal for the high current ranges, this eliminates the need to change cables during a procedure. A 5720A or 5700A Series II paired with a 5725A can also be configured to source all current (both standard calibrator-generated outputs and its own outputs) through the 5725A binding posts.



# ***Appendices***

<b>Appendix</b>	<b>Title</b>	<b>Page</b>
A	Fault Codes.....	A-1
B	ASCII and IEEE Bus Codes.....	B-1
C	Symbolic Names of Calibration Constants .....	C-1
D	Glossary.....	D-1



# **Appendix A**

## **Fault Codes**

<b>100-Level Faults: Air Flow Monitoring Subsystem</b>	
100	Low Air Flow
<b>200-Level Faults: 5725 Boost System</b>	
200	5725 No Error
201	5725 Self-Test ROM Failure
202	5725 Self-Test RAM Failure
203	5725 Self-Test EEPROM Failure
204	5725 Self-Test Data Bus Failure
205	5725 Self-Test CLAMPS Circuit Failure
206	5725 Self-Test HVCLR Circuit Failure
207	5725 Self-Test DAC Failure
208	5725 Self-Test Watchdog Timer Failure
209	5725 Current Heatsink Too Hot
210	Output Tripped To Standby
211	5725 Current Compliance Voltage Too High
212	5725 Current Compliance Voltage Too High
213	5725 +400V Supply Did Not Shut Off
214	5725 -400V Supply Did Not Shut Off
215	5725 Voltage Heatsink Too Hot
216	5725 Voltage Heatsink Too Hot
217	5725 +400V Supply Too Small
218	5725 +400V Supply Too Large
219	5725 -400V Supply Too Large
220	5725 -400V Supply Too Small

221	5725 +400V Supply Current Too High
222	Output Tripped To Standby
223	5725 -400V Supply Current Too High
224	Output Tripped To Standby
225	5725 Fan Not Working
226	5725 CLAMPS Fault
227	Output Tripped To Standby
228	5725 Software TRAP
229	5725 Cable Was Off
230	5725 RESET (power-up or watchdog timer)
231	5725 Guard-Crossing Timeout
232	5725 Illegal/Unexecutable Command
233	5725 Non-Maskable Interrupt Occurred
234	5725 HVCLEAR Circuit Activated
235	Output Tripped To Standby
<b>400-Level Faults: Calibration Constant Subsystem</b>	
400	Bad Cal Constant ID
<b>500-Level Faults: Configuration Finder Subsystem</b>	
500	Bad Mode To CNFmodeRanges
501	Configuration Table Overflow
502	Bad Amplifier Type Selection
503	Bad Flat Constant Type Selection
504	Bad Flat Constant Type In Table
505	5725 Guard Crossing Wouldn't Start
<b>600-Level Faults: Dot Matrix Display Driver Subsystem</b>	
600	Bad Row Selector
601	Bad Column Argument
602	Bad Character
<b>800-Level Faults: Executive Subsystem</b>	
800	Wideband Module Needed
801	Amplifier Not Selected Or Connected
802	Amplifier Must Remain On For This Output
803	Over Limits Of Locked Range
804	Under Limits Of Locked Range

806	Invalid Date
807	Invalid Time
808	DC dBm Not Allowed
809	Ext Ref Value Out Of Range
810	Bad Edit Digit Movement
811	Not Wideband Units
812	Cannot Set Frequency With Ohms
813	Bad Units
814	Wrong Polarity For Limit
815	Outside Entry Limits
816	Magnitude Too Large For Calibrator
817	Magnitude Too Small For Calibrator
818	Frequency Too Large For Calibrator
819	Frequency Too Small For Calibrator
820	Calibrator Cannot Source That Value
821	V Limit Outside Calibrator Ability
822	I Limit Outside Calibrator Ability
823	Cannot Adjust Frequency To $\leq 0$ Hz
824	Offset Not Allowed Now
825	Scale Not Allowed Now
826	Ohms Reading Set Too High
827	Ohms Reading Set Too Low
828	Cannot Use External Sense Now
829	Cannot Use Phase Shift Now
830	Cannot Use Phase Lock Now
831	Cannot Use 2-ire Comp Now
832	Could not Do Default Wideband Output
833	Bad Selector For Set/Get Item
834	Cannot Boost This Output Mode
835	Cannot Use Ext Sense On Selected Range
836	Cannot Use 2 Wire Comp On Selected Range
837	Cannot Lock This Range
838	Cannot Set Clock, Rear Switch In NORMAL
839	Cannot Fmt EEPROM, Rear Switch In NORMAL

840	Illegal Output Post For Current
841	No 5725 Available For Selected Output
842	Not A Valid Wideband Flatness Point
843	Wideband Flatness Cal Is Not Active
844	Report String Too Long
845	Cannot Store, Rear Switch In NORMAL
846	Range Calibration Is Not Active
847	Magnitude Too High For Range Cal
848	Magnitude Too Low For Range Cal
849	Invalid Calibrator Setup Block
850	Cannot Format, 5725 Switch In NORMAL
851	Cannot Store, 5725 Switch In NORMAL
852	Calibration Steps Out Of Order
853	Cannot Use External Guard Now
854	Cannot Use Ext Guard On Selected Range
855	Cannot Set String, Rear Switch in NORMAL
856	Present Output Exceeds Selected Limit
857	Bad Selector For Reference Calibration
858	Cannot Change Range Now
859	Hardware Not Installed For This Range
860	Cannot Use Amplifier For This Output
861	5725 Cannot Ext Sense At That Frequency
<b>900-Level Faults: Keyboard Driver Subsystem</b>	
900	Keyboard Output Queue Full
<b>1000-Level Faults: 5725 Communication Receive Subsystem</b>	
1000	Could not ACK Packet From 5725
1001	Illegal 5725 Receive Task State
1002	Bad Receive Packet Number From 5725
1003	Bad Control Byte From 5725
<b>1100-Level Faults: 5725 Communication Transmit Subsystem</b>	
1100	Multiple Timeouts Sending To 5725
1101	5725 Request Reset Loop
1102	Unexpected NSA From 5725
1103	Bad Packet Number In ACK From 5725

1104	Bad Control Byte From 5725 Receive Task
1105	Illegal 5725 Transmit Task State
1106	5725 Indefinite ACKWAIT Holdoff
<b>1200-Level Faults: 5725 Communication Utility Subsystem</b>	
1200	Serial Write Failure To 5725
1201	Packet Too Large For 5725
<b>1300-Level Faults: Output Monitor Subsystem</b>	
1300	Undefined Signal
1301	Output Tripped To Standby
1302	Output Tripped To Standby
1303	DC Zero Calibration is Needed (Every 30 Days)
<b>1400-Level Faults: Software Timer Subsystem</b>	
1400	Cannot Install MTtick()
1401	Bad Timer Selector
<b>1500-Level Faults: Guard Crossing Receive Subsystem</b>	
1500	Could not ACK Packet From Inguard
1501	Illegal Inguard Receive Task State
1502	Bad Receive Packet Number From Inguard
1503	Bad Control Byte From Inguard
<b>1600-Level Faults: Guard Crossing Transmit Subsystem</b>	
1600	Multiple Timeouts Sending To Inguard
1601	Inguard Request Reset Loop
1602	Unexpected NSA From Inguard
1603	Bad Packet Number In ACK From Inguard
1604	Bad Control Byte From Inguard Rcv Task
1605	Illegal Inguard Transmit Task State
1606	Inguard Indefinite ACKWAIT Holdoff
<b>1700-Level Faults: Guard Crossing Utility Subsystem</b>	
1700	Serial Write Failure To Inguard
1701	Packet Too Large For Inguard
<b>1800-Level Faults: Normal Output Operations Subsystem</b>	
1800	DORMANT To OPERATE
1801	Bad Transition Type

1802	Bad Boolean Selector
1803	NRMrngStby Encountered Error
1804	DCV Called For Non-DCV Range
1805	ACV Called For Non-ACV Range
1806	Bad ACV Frequency Range
1807	Hi Res Frequency Too High
1808	ACV Amplitude Correction Failure
1809	Cannot Phase Lock To Signal
1810	Bad Phase Quadrant
1811	Current Called for Non-Current Range
1812	Ohms Called for Non-Ohms Range
1813	Cannot Phase Lock, Output Not AC
1814	Cannot Phase Shift, Output Not AC
1815	Bad Wide Band Range
1816	Freq. Too High Even For Wide Band
1817	Illegal Current Output Location
1818	Output Current Out Of Tolerance
1819	Current Compliance Voltage Exceeded
1820	2-Wire Compensation Current Exceeded
1821	NRMbstcur Passed Bad Range
1822	5220 No Longer Connected
1823	5220 Detected Fault And Shut Off
1824	5205 No Longer Connected
1825	5205 Detected Fault And Shut Off
1826	5725 No Longer Connected
1827	14 Bit DAC Scaling Found Zero Output
<b>1900-Level Faults: Non-Volatile Subsystem</b>	
1900	Could not Write Byte To EEPROM
1901	Checksum Error Reading EEPROM
1902	EEPROM Is Full
1903	Unknown Nonvolatile Constant Selector
1904	EEPROM Partition Is Full
1905	Could not Write Byte To 5725 EEPROM
1906	Checksum Error Reading 5725 EEPROM

<b>2000-Level Faults: Analog Operations Manager Subsystem</b>	
2000	Bad Command Code
2001	Bad Signal
2002	Long Term Command In Progress
2003	Guard Crossing Protocol Failed To Start
2004	Fatal Fault, Output Tripped
2005	Tripped While Calibrating or Diagnosing
<b>2100-Level Faults: Output Display Driver Subsystem</b>	
2100	Bad Display Selector
2101	Bad Character
2102	Bad Annunciator Selector
<b>2200-Level Faults: Remote Interface Subsystem</b>	
2200	Unknown Command
2201	Invalid Number Of Parameters
2202	Invalid Cal Constant Name
2203	Invalid Keyword
2204	Invalid Range
2205	Invalid Parameter Type
2206	Invalid Parameter Unit
2207	Invalid Parameter Value
2208	IEEE488.2 I/O DEADLOCK
2209	Spare
2210	IEEE488.2 INTERRUPTED Query
2211	Not Allowed From GPIB Interface
2212	Not Allowed From Serial Interface
2213	Remote Only
2214	Invalid Syntax
2215	IEEE488.2 UNTERMINATED Command
2216	Symbol Table Overflow
2217	Command Reserved For Service
2218	Invalid Binary Number
2219	Invalid Binary Block
2220	Invalid Character

2221	Invalid Decimal Number
2222	Invalid Hexadecimal Block
2223	Invalid Hexadecimal Number
2224	Too Many Parameters
2225	Invalid Octal Number
2226	Too Many Characters
2227	Invalid String
2228	Invalid Register Address
2229	Invalid Cal Constant Name
2230	Remote Serial Port Dead
2231	IEEE488.2 Query After Indef Response
<b>2300-Level Faults: Executive Subsystem</b>	
2300	Unknown Report Requested
2301	Unknown Report Device Requested
2302	Serial Port Timeout
<b>2400-Level Faults: Real Time Clock Subsystem</b>	
2400	Cannot Install Interrupt Handler
2401	Unknown Interrupt Selector
2402	Bad Date & Cannot Be Set
<b>2500-Level and 2600-Level Faults: Self Calibration Subsystem</b>	
2500	Invalid Cal Procedure Number
2501	Could not Ext Cal Gain
2502	Could not Ext Cal Ref
2503	Could not Ext Cal Neg
2504	Could not Cal Ratio
2505	Could not Cal Pos 11V or 22V DC Zero
2506	Could not Cal Neg 11V or 22V DC Zero
2507	Could not Cal Pos 11V or 22V DC Gain
2508	Could not Cal 6.5V or 13V Buf Ref
2509	Could not Cal 2.2V Zero
2510	Could not Cal 220 mV Gain S1
2511	Could not Cal 220 mV Gain S2
2512	Could not Cal 220 mV Gain S3

2513	Could not Cal 220 mV Gain S4
2514	Could not Cal 220V DC Offset
2515	Could not Cal 220V DC Rnet
2516	Could not Cal 220V DC Gain
2517	Could not Cal ACV Gain
2518	Flatness Cal: Main Sensor Fail?
2519	Flatness Cal: AC Cal Sensor Fail?
2520	Could not Cal Fine Tune (14 bit) DAC
2521	Could not Cal Fine Tune 15th bit Down
2522	Could not Cal Fine Tune 15th bit Up
2523	Could not Cal 2.2 mV/22 mV step 1
2524	Could not Cal 2.2 mV/22 mV step 2
2525	Could not Cal 220V AC Offset
2526	Could not Cal 220V AC Gain
2527	Could not Cal 220 mV Offset
2528	Could not Cal 1100V AC/DC Offset
2529	Could not Cal 1100V AC/DC Gain
2530	Could not Cal 220 $\mu$ A DC Zero
2531	Could not Cal 2.2 mA DC Zero
2532	Could not Cal 22 mA DC Zero
2533	Could not Cal 220 mA DC Zero
2534	Could not Cal 2.2A DC Zero
2535	Could not Cal 220 $\mu$ A DCI (Meas 1)
2536	Could not Cal 220 $\mu$ A DCI (Meas 2)
2537	Could not Cal 2.2 mA DCI (Meas 1)
2538	Could not Cal 2.2 mA DCI (Meas 2)
2539	Could not Cal 22 mA DCI (Meas 1)
2540	Could not Cal 22 mA DCI (Meas 2)
2541	Could not Cal 220 mA DCI (Meas 1)
2542	Could not Cal 220 mA DCI (Meas 2)
2543	Could not Cal 2.2A DCI (Meas 1)
2544	Could not Cal 2.2A DCI (Meas 2)
2545	Could not Ext Cal 10K Ohm Std (Meas 1)

**5700A/5720A Series II***Operators Manual*

---

2546	Could not Ext Cal 10K Ohm Std (Meas 2)
2547	Could not Ext Cal 10K Ohm Std (Meas 3)
2548	Could not Cal 10K Ohm (Meas 1)
2549	Could not Cal 10K Ohm (Meas 2)
2550	Could not Cal 10K Ohm (Meas 3)
2551	Could not Cal 19K Ohm (Meas 1)
2552	Could not Cal 19K Ohm (Meas 2)
2553	Could not Cal 19K Ohm (Meas 3)
2554	Could not Cal 100K Ohm (Meas 1)
2555	Could not Cal 100K Ohm (Meas 2)
2556	Could not Cal 190K Ohm (Meas 1)
2557	Could not Cal 190K Ohm (Meas 2)
2558	Could not Cal 1M Ohm (Meas 1)
2559	Could not Cal 1M Ohm (Meas 2)
2560	Could not Cal 1.9M Ohm (Meas 1)
2561	Could not Cal 1.9M Ohm (Meas 2)
2562	Could not Cal 10M Ohm (Meas 1)
2563	Could not Cal 10M Ohm (Meas 2)
2564	Could not Cal 19M Ohm (Meas 1)
2565	Could not Cal 19M Ohm (Meas 2)
2566	Could not Cal 100M Ohm (Meas 1)
2567	Could not Cal 1K Ohm (Meas 1)
2568	Could not Cal 1K Ohm (Meas 2)
2569	Could not Cal 1.9K Ohm (Meas 1)
2570	Could not Cal 1.9K Ohm (Meas 2)
2571	Could not Cal 100 Ohm (Meas 1)
2572	Could not Cal 100 Ohm (Meas 2)
2573	Could not Cal 190 Ohm (Meas 1)
2574	Could not Cal 190 Ohm (Meas 2)
2575	Could not Cal Ohms Divider (Meas 1)
2576	Could not Cal Ohms Divider (Meas 2)
2577	Could not Cal 10 Ohm (Meas 1)
2578	Could not Cal 10 Ohm (Meas 2)

2579	Could not Cal 19 Ohm (Meas 1)
2580	Could not Cal 19 Ohm (Meas 2)
2581	Could not Ext Cal 1 Ohm (0.26V CM Meas)
2582	Could not Ext Cal 1 Ohm (Ext Meas)
2583	Could not Ext Cal 1 Ohm (0.13V CM Meas)
2584	Could not Ext Cal 1 Ohm (Int Meas)
2585	Could not Ext Cal 1.9 Ohm (0.18V CM Meas)
2586	Could not Ext Cal 1.9 Ohm (0.12V CM Meas)
2587	Could not Ext Cal 1.9 Ohm (Int Meas)
2588	Could not Cal Wideband Gain
2589	Bad Cal Step Selector
2590	A/D Appears To Have Failed
2591	User Range Gain Adjustment Is 0
2592	Stored User Range Gain Adjust Is 0
2593	220 $\mu$ A AC Flatness Calibration Failed
2594	2.2 mA AC Flatness Calibration Failed
2595	22 mA AC Flatness Calibration Failed
2596	220 mA AC Flatness Calibration Failed
2597	Bad Range Number For IAC Flatness Cal
2598	No Data For DCI Calibration
2599	2.2V AC Flat Early Fail
2600	2.2V AC Flat Bad AC Cal Sensor?
2601	2.2V AC Flat Diverge
2602	22V AC Flat Early Fail
2603	22V AC Flat Bad AC Cal Sensor?
2604	22V AC Flat Diverge
2605	220V AC Flat Early Fail
2606	220V AC Flat Bad AC Cal Sensor?
2607	220V AC Flat Diverge
2608	1100V AC Flat Early Fail
2609	1100V AC Flat Bad AC Cal Sensor?
2610	1100V AC Flat Diverge
2611	220 $\mu$ A IAC Flat Early Fail

2612	220 $\mu$ A IAC Flat Bad AC Cal Sensor?
2613	220 $\mu$ A IAC Flat Diverge
2614	2.2 mA IAC Flat Early Fail
2615	2.2 mA IAC Flat Bad AC Cal Sensor?
2616	2.2 mA IAC Flat Diverge
2617	22 mA IAC Flat Early Fail
2618	22 mA IAC Flat Bad AC Cal Sensor?
2619	22 mA IAC Flat Diverge
2620	220 mA IAC Flat Early Fail
2621	220 mA IAC Flat Bad AC Cal Sensor?
2622	220 mA IAC Flat Diverge
2623	2.2A IAC Flat Early Fail
2624	2.2A IAC Flat Bad AC Cal Sensor?
2625	2.2A IAC Flat Diverge
2626	Illegal Ohms Null Function State
2627	Unknown Source Divider Identifier
2628	No Data For Ohms Calibration
2629	Illegal Ohms Calibration Config
2630	Illegal Number Of Ohms Cal Points
2631	5725 Shunt 0A Meas Fail
2632	5725 Shunt 1.3A Meas Fail
2633	5725 Current Amplifier Zero Meas Fail
2634	5725 Current Amplifier Gain Meas Fail
2635	Wideband Thermal Sensor Cal Diverge
2636	Wideband Sensor Amp Offset Too Big
2637	Wideband Ext Cal Point Bad Const ID
2638	5725 ACV Sense Amp Offset Diverge
2639	5725 ACV Sense Amp Gain Diverge
2640	5725 ACV Flatness Ref Freq Failure
2641	5725 ACV Flatness Cal Freq Failure
2642	External V Reference Value Out Of Range
2643	5725 Diagnostic DAC Cal Didn't Converge
2644	Spare

2645	Spare
2646	DAC Appears To Not Meet Linearity Spec
2647	ACV Buffer Offset Too Large
2648	5725 ACV Flat Test Cap Too Large
2649	5725 ACV Flat Test Cap Too Large
2650	Could not Cal 100M Ohm (Meas 2)
<b>2700-Level Faults: Self Diagnostics Subsystem (Current)</b>	
2700	A7: 8255 Control Word
2701	A7: 8255 Port A Fault
2702	A7: 8255 Port B Fault
2703	A7: 8255 Port C Fault
2705	A7: Oven Regulation Fault
2706	A7: Current Compliance Fault
2707	A7: Hardware Initialization Fault
2709	A7: Current Magnitude Fault
2710	A7: Dummy Load Current Fault
2711	Assembly A7 Is Not Responding
2712	A7: Hi-Res Clock Fault
2713	A7: Hi-Res Loop Fault In 100HZ Range
2714	A7: Hi-Res Loop Fault In 1KHZ Range
2715	A7: Hi-Res Loop Fault In 10KHZ Range
2716	A7: Hi-Res Loop Fault In 100KHZ Range
2717	A7: Hi-Res Loop Fault In 1MHZ Range
2718	Fault In Setting Up AC For Diagnostics
2719	A7: 8255 Was Reset
<b>2800-Level Faults: Self Diagnostics Subsystem (DAC)</b>	
2800	A11: 8255 Control Word
2801	A11: 8255 Port A Wires
2802	A11: 8255 Port B Data Bus
2803	A11: 82C54 Status Words
2804	A11: DAC Heaters Not Regulated
2805	5700 Not Warmed Up
2806	A11: ADC Amp Output Noise

2807	A11: ADC Amp Output Offset
2808	A11: ADC Amp Gain Error
2809	A11: DAC Monitoring Fault
2810	A11: +11V DC Range Fault
2811	A11: -11V DC Range Fault
2812	A11: +22V DC Range Fault
2813	A11: -22V DC Range Fault
2814	A11: 6.5V Buffered Reference Fault
2815	A11: 6.5V Reference Fault
2816	A11: 13V Buffered Reference Fault
2817	A11: 13V Reference Fault
2818	Assembly A11 Missing
2819	A11: 8255 Was Reset
2820	A11: Fine Adjust Channel Fault
2821	A8/A11: +11/22V DC Zero Estimate Fault
2822	A8/A11: -11/22V DC Zero Estimate Fault
2823	A11: Could not Estimate +11V Or 22V Gain
2824	A11: Could not Estimate 6.5V Or 13V Ref
2825	A11: Could not Estimate 6.5V Or 13V Buf Ref
2826	A11: A/D Overload Fault
<b>3100-Level Faults: Self Diagnostics Subsystem (High Voltage)</b>	
3100	A14: 8255 Control Word
3101	A14: 8255 Port A Fault
3102	A14: 8255 Port B Fault
3103	A14: 8255 Port C Fault
3104	A15: HV Oven Regulation Fault
3105	A15: HV I Oven Regulation Fault
3106	A15: DC HV Amp Noise Fault
3107	A15: DC HV Amp Offset Fault
3108	A15: DC HV Amp Gain Fault
3109	A15: HV +DC Preamplifier Fault
3110	A15: HV +DC Series Pass & Current Fault
3111	A15: HV +DC High Voltage Output Fault

3112	A15: HV +DC Ref/Error Amplitude Fault
3113	A15: HV -DC Preamplifier Fault
3114	A15: HV -DC Series Pass & Current Fault
3115	A15: HV -DC High Voltage output Fault
3116	A15: HV -DC Reference/Error Amp Fault
3117	A14/A15: HV +DC Current Error Amp Fault
3118	A14/A15: HV -DC Current Error Amp Fault
3119	A14/A15: HV +DC Current Abs. Value
3120	A14/A15: HV -DC Current Abs. Value
3122	A14/A15: HV AC 1KHZ, Preamp Fault (lo)
3123	A14/A15: HV AC 1KHZ, Preamp Fault (mid)
3124	A14/A15: HV AC 1KHZ, Preamp Fault (hi)
3125	A14/A15: HV AC 100HZ, Preamp Fault (lo)
3126	A14/A15: HV AC 100HZ, Preamp Fault
3127	A14/A15: HV AC 100HZ, Preamp Fault (hi)
3128	A14/A15: HV AC 1KHZ, Output Fault (lo)
3129	A14/A15: HV AC 1KHZ, Output Fault (mid)
3130	A14/A15: HV AC 1KHZ, Output Fault (hi)
3131	A14/A15: HV AC 100HZ, Output Fault (lo)
3132	A14/A15: HV AC 100HZ, Output Fault (mid)
3133	A14/A15: HV AC 100HZ, Output Fault (hi)
3135	Assembly A14 Not Responding
3136	A14: 8255 Was Reset
3137	A14/A15/A16: 2.2A AC Range Mag. Fault
3138	A14/A15/A16: 2.2A AC Range Compliance
3139	A14/A15/A16: 2.2A AC Range Amplitude
3140	A14/A15/A16: 2.2A AC Range Abs. Value
3141	A14/A15/A16: 2.2A DC Range Dummy Load
3142	A14/A15/A16: 2.2A DC Range Compliance
3143	A14/A15/A16: 2.2A DC Range Magnitude

<b>3200-Level Faults: Self Diagnostics Subsystem (misc)</b>	
3200	Assemblies Missing
3201	Unknown Diagnostic Test
3202	5725 ACV Sense Amp Fault
3203	5725 ACV Standby 5725 Fault
3204	5725 ACV Operate 5725 Fault
3205	5725 ACV Cal Sensor Test Died
3206	5725 ACV Cal Sensor Fault
3207	5725 ACV VLF (100 Hz) Won't Converge
3208	5725 ACV LF (1 kHz) Won't Converge
3209	5725 ACV MF (10 kHz) Won't Converge
3210	5725 ACV HF (100 kHz) Won't Converge
3211	5725 Current Path To Shunt Open
3212	5725 Shunt Sense Open
3213	5725 Shunt Measurement Out Of Tolerance
3214	5725 Current Amplifier Offset Too Large
3215	5725 Current Drive Path Open
3216	5725 Current Error Amplifier Failure
3217	5725 Amplifer Not Connected
<b>3300-Level Faults: Self Diagnostics Subsystem (Ohms)</b>	
3300	A9: 8255 Control Word
3301	A9: 8255 Port A Fault
3302	A9: 8255 Port B Fault
3303	A9: 8255 Port C Fault
3304	A9: 10V Source Fault
3305	A9: 5V Source Fault
3306	A9: 2V Source Fault
3308	A9: Diff Amp Offset Fault
3309	A9: Diff Amp Gain Fault
3310	A9: Diff Amp Noise Fault
3311	A9/A10: Ohms 10:1 Divider Fault
3312	A9/A10: Ohms 1:1 Divider Fault

3313	A9/A10: 10K Ohm Diagnostic Fault
3314	A9/A10: 19K Ohm Cal Diag Fault
3315	A9/A10: 10 Ohm Cal Diag Fault
3316	A9/A10: 19 Ohm Cal Diag Fault
3317	A9/A10: 100K Ohm Ratio Fault
3318	A9/A10: 190K Ohm Ratio Fault
3319	A9/A10: 1M Ohm Ratio Fault
3320	A9/A10: 1.9M Ohm Ratio Fault
3321	A9/A10: 10M Ohm Ratio Fault
3322	A9/A10: 19M Ohm Ratio Fault 1
3323	A9/A10: 19M Ohm Ratio Fault 2
3324	A9/A10: 100M Ohm Ratio Fault
3325	A9/A10: 10K Ohm Check Fault
3326	A9/A10: 19K Ohm Check Fault
3327	A9/A10: 1K Ohm Check Fault
3328	A9/A10: 1.9K Ohm Check Fault
3329	A9/A10: 100 Ohm Check Fault
3330	A9/A10: 190 Ohm Check Fault
3331	A9/A10: 10 Ohm Check Fault
3332	A9/A10: 19 Ohm Check Fault
3333	A9/A10: 1 Ohm Check Fault
3334	A9/A10: 1.9 Ohm Check Fault
3335	A9/A10: Ohms Short Check Fault
3336	A9/A10: 2 Wire Compensation Fault
3337	A9/A10: Ohms Correction Factor Fault
3338	Assembly A9 Not Responding
3339	A9: 8255 Was Reset
3340	A9/A10: 100 Ohm Cal Diag Fault
3341	A9/A10: 190 Ohm Cal Diag Fault

3400-Level Faults: Self Diagnostics Subsystem (Oscillator)	
3400	A12: 8255 Control Word
3401	A12: 8255 Port A
3402	A12: 8255 Port B
3403	A12: 8255 Port C
3404	A13: 8255 Control Word
3405	A13: 8255 Port A
3406	A13: 8255 Port B
3407	A13: 8255 Port C
3408	A13: Fixed Ampl. Osc Fault
3409	A13: Phase Lock Loop Fault
3410	A12/A13: 22V Amp Bias Adj Error
3411	A12/A13: 22V Amp Nonfunctional
3412	A12 To A13 Interface Fault
3413	A12/A13: 14 bit DAC Nonfunctional
3414	A12/A13: Nonlinear Control Loop 2Vrng
3415	A12/A13: nonlinear Control Loop 20Vrng
3416	A12/A13: DAC 15th Bit Fault
3417	A12: DC Sensor Buffer Fault
3418	A12: Sensor Loop/Sq. Root Amp Fault
3419	A12: AC Sensor Buff (2V Range)
3420	A12: AC Sensor Buff (20V Range)
3421	A12: AC Cal Sensor (2V Range)
3422	A12: AC Cal Sensor (20V Range)
3423	Assembly A12 Missing
3424	Assembly A13 Missing
3425	Assembly A12 Or A13 Not Responding
3426	A12: 8255 Was Reset
3427	A13: 8255 Was Reset

<b>3500-Level Faults: Self Diagnostics Subsystem (Power Amp)</b>	
3500	A16: 8255 Control Word
3501	A16: 8255 Port A
3502	A16: 8255 Port B
3503	A16: 8255 Port C
3507	A16: PA Supplies Are Off
3508	A16/A14: 220V AC Range Output Fault
3509	A16: Amplifier Loop Not Regulated
3510	A16: 220V Amp Fault
3511	A16: Incorrect PA Input
3520	A16: PA Oven Regulation Fault
3521	Assembly A16 Is Not Responding
3524	A16: Power Amp Is Too Hot
3525	220V DC Initialization Fault
3526	220V AC Initialization Fault
3527	A16: Power Amp DC Cal Network Zero Fault
3528	A16: Power Amp DC Cal Network Gain Fault
3529	A16: Pwr Amp 220V Range Attenuator Fault
3530	A16: 8255 Was Reset
<b>3600-Level Faults: Self Diagnostics Subsystem (Power Supplies)</b>	
3600	+17S Supply Fault
3601	-17S Supply Fault
3602	+15S Supply Fault
3603	-15S Supply Fault
3604	+42S Supply Fault
3605	-42S Supply Fault
3606	LH COM Ground Fault
3607	-5LH Supply Fault
3608	5RLH Supply Fault
3609	8RLH Supply Fault
3610	+PASupply Fault
3611	-PASupply Fault
3612	+15 OSC Supply Fault

3613	-15 OSC Supply Fault
3614	OSC COM Ground Fault
3615	S COM Ground Fault
<b>3700-Level Faults: Self Diagnostics Subsystem (Rear I/O)</b>	
3700	A21: 8255 Control Word
3701	A21: 8255 Port A Fault
3702	A21: 8255 Port B Fault
3703	A21: 8255 Port C Fault
3704	Assembly A21 Not Responding
3705	A21: Rear Panel Data Bus Fault
3708	A21: 8255 Was Reset
<b>3800-Level Faults: Self Diagnostics Subsystem (Switch Matrix)</b>	
3800	A8: 8255 Control Word
3801	A8: 8255 Port A Fault
3802	A8: 8255 Port B Fault
3803	A8: 8255 Port C Fault
3804	A8: Zero Amp Lo Noise Fault
3805	A8: Zero Amp Lo Offset
3806	A8: Zero Amp Lo Gain Fault
3807	A8: Zero Amp Hi Noise Fault
3808	A8: Zero Amp Hi Offset
3809	A8: Zero Amp Hi Gain Fault
3810	A8: 2.2V Amp Noise Fault
3811	A8: Zero Amp Offset
3812	A8: 2.2V Gain Fault
3813	A8: 220mV Offset Fault
3814	A8: 220mV Divider Fault
3815	A8: 22mV Divider Fault
3818	A8: Out Lo To Sense Lo Continuity Fault
3819	A8: Relay Fault
3824	A8: Oven Regulation Fault
3825	Assembly A8 Not Responding

3826	A8: 8255 Was Reset
3827	Assembly A8 Too Hot
<b>3900-Level Faults: Self Diagnostics Subsystem (Wideband)</b>	
3900	A5: 8255 Control Word
3901	A5: 8255 Port A Fault
3902	A5: 8255 Port B Fault
3903	A5: 8255 Port C Fault
3904	Optional Assemblies A5/A6 Are Missing
3905	A6: Phase Lock Loop Fault
3906	A6: Phase Lock Loop Fault At 30Mhz
3907	A5: RMS Sensor Fault
3908	A5: RMS Sensor Fault At 30Mhz
3909	A5: RMS Sensor Fault At 6.5V DC in
3910	A5/A6: Ampl. Control Fault
3911	A5/A6: Ampl. Control Fault At 30Mhz
3912	A5/A6: Output Offset Fault
3913	A5/A6: Output Offset Fault At 30Mhz
3914	A5: 0DB Output Attenuation Fault
3915	A5: 10DB Output Attenuation Fault
3916	A5: 20DB Output Attenuation Fault
3917	A5: 30DB Output Attenuation Fault
3918	A5: 40DB Output Attenuation Fault
3922	A5/A6: Wideband Initialization Fault
3923	A5: 8255 Was Reset
<b>4000-Level Faults: Analog Sequencing Subsystem</b>	
4000	Bad Sequence ID
4001	Over Nested Subsequences
4002	Bad Sequence Command Code
4003	Bad Reply Size From Inguard
4004	Reply From Inguard Too Small
4005	False MSG Semaphore from Inguard
4006	Inguard CPU POP

4007	Inguard CPU Reset
4008	Inguard CPU A/D Timeout
4009	Inguard CPU Timed Out On Main CPU
4010	Inguard CPU Detected A Command Error
4011	Bad Y5000 Get/Set Selector
4012	Sequencer Timed Out Waiting For Inguard
4013	Illegal Analog State Command For 5725
4014	Sequencer Timed Out Waiting for 5725
4015	Could not Queue Command To 5725 BX
4016	Reply From 5725 Was Garbled
<b>4100-Level Faults: Serial Interface Driver Subsystem</b>	
4100	Bad Virtual channel
4101	Framing
4102	Input Queue Overflow
4103	Overrun
4104	Parity
4105	Uart Failed Self Test
4106	Serial Port 0
4107	Serial Port 1
4108	Guard Crossing UART
4109	Serial Port 3
4110	Remote Interface UART
4111	Boost Crossing UART
<b>4200-Level Faults: Instrument State Manager Subsystem</b>	
4200	Bad Boolean Value Selector
4201	Meaningless Target State Value
4202	Meaningless Actual State Value
4203	Mystery Target/Actual State Difference

<b>4300-Level Faults: Self Test Subsystem</b>	
4301	ROM Checksum
4302	RAM
4303	Real Time Clock
4304	Keyboard
4305	Output Display
4306	Control Display
4307	IEEE488
4308	Rear Panel DUART
4309	Guard Crossing DUART
4310	Interrupt Hardware
4311	Inguard CPU ROM Fault
4312	Inguard CPU RAM Fault
4313	Front Panel Refresh Fault
<b>4400-Level Faults: General Purpose Utility Subsystem</b>	
4400	Invalid Command
<b>4500-Level Faults: Analog Value Finder Subsystem</b>	
4500	VFdcDac Value Out Of DAC Range
4501	Bad Range Selector
4502	Non-Vfinder Range
4503	Bad DAC ICALL
4504	User Range Adjust of 0 (I used 1)
4505	Divide By 0 In (VF)correct
<b>4600-Level Faults: Watch Dog Monitoring Subsystem</b>	
4600	Watchdog Timed Out
<b>4700-Level Faults: Operating Kernel Subsystem</b>	
4700	Kstart Returned
4701	Task Termination
4702	No Signal Handler
4703	Ksuspend( ) When Not RUNNING
4704	Ksleep( ) When Not RUNNING
4705	Kewait( ) When Not RUNNING



***Appendix B***  
***ASCII and IEEE Bus Codes***



ASCII CHAR.	DECIMAL	OCTAL	HEX	BINARY 7654 3210	DEV. NO.	MESSAGE ATN=TRUE	ASCII CHAR.	DECIMAL	OCTAL	HEX	BINARY 7654 3210	DEV. NO.	MESSAGE ATN=TRUE
NUL	0	000	00	0000 0000			@	64	100	40	0100 0000	0	MTA
SQH	1	001	01	0000 0001		GTL	A	65	101	41	0100 0001	1	MTA
STX	2	002	02	0000 0010			B	66	102	42	0100 0010	2	MTA
ETX	3	003	03	0000 0011			C	67	103	43	0100 0011	3	MTA
EOT	4	004	04	0000 0100		SDC	D	68	104	44	0100 0100	4	MTA
ENQ	5	005	05	0000 0101		PPC	E	69	105	45	0100 0101	5	MTA
ACH	6	006	06	0000 0110			F	70	106	46	0100 0110	6	MTA
BELL	7	007	07	0000 0111			G	71	107	47	0100 0111	7	MTA
BS	8	010	08	0000 1000		GET	H	72	110	48	0100 1000	8	MTA
HT	9	011	09	0000 1001		TCT	I	73	111	49	0100 1001	9	MTA
LF	10	012	0A	0000 1010			J	74	112	4A	0100 1010	10	MTA
VT	11	013	0B	0000 1011			K	75	113	4B	0100 1011	11	MTA
FF	12	014	0C	0000 1100			L	76	114	4C	0100 1100	12	MTA
CR	13	015	0D	0000 1101			M	77	115	4D	0100 1101	13	MTA
SO	14	016	0E	0000 1110			N	78	116	4E	0100 1110	14	MTA
SI	15	017	0F	0000 1111			O	79	117	4F	0100 1111	15	MTA
DLE	16	020	10	0001 0000		LL0	P	80	120	50	0101 0000	16	MTA
DC1	17	021	11	0001 0001			Q	81	121	51	0101 0001	17	MTA
DC2	18	022	12	0001 0010			R	82	122	52	0101 0010	18	MTA
DC3	19	023	13	0001 0011			S	83	123	53	0101 0011	19	MTA
DC4	20	024	14	0001 0100		DCL	T	84	124	54	0101 0100	20	MTA
NAK	21	025	15	0001 0101		PPU	U	85	125	55	0101 0101	21	MTA
SYN	22	026	16	0001 0110			V	86	126	56	0101 0110	22	MTA
ETB	23	027	17	0001 0111			W	87	127	57	0101 0111	23	MTA
CAN	24	030	18	0001 1000		SPE	X	88	130	58	0101 1000	24	MTA
EM	25	031	19	0001 1001		SPD	Y	89	131	59	0101 1001	25	MTA
SUB	26	032	1A	0001 1010			Z	90	132	5A	0101 1010	26	MTA
ESC	27	033	1B	0001 1011			[	91	133	5B	0101 1011	27	MTA
FS	28	034	1C	0001 1100			\	92	134	5C	0101 1100	28	MTA
GS	29	035	1D	0001 1101			]	93	135	5D	0101 1101	29	MTA
RS	30	036	1E	0001 1110			^	94	136	5E	0101 1110	30	MTA
US	31	037	1F	0001 1111			_	95	137	5F	0101 1111	31	MTA
SPACE	32	040	20	0010 0000	0	MLA	`	96	140	60	0111 0000	0	MSA
!	33	041	21	0010 0001	1	MLA	a	97	141	61	0111 0001	1	MSA
"	34	042	22	0010 0010	2	MLA	b	98	142	62	0111 0010	2	MSA
#	35	043	23	0010 0011	3	MLA	c	99	143	63	0111 0011	3	MSA
\$	36	044	24	0010 0100	4	MLA	d	100	144	64	0111 0100	4	MSA
%	37	045	25	0010 0101	5	MLA	e	101	145	65	0111 0101	5	MSA
&	38	046	26	0010 0110	6	MLA	f	102	146	66	0111 0110	6	MSA
'	39	047	27	0010 0111	7	MLA	g	103	147	67	0111 0111	7	MSA
(	40	050	28	0010 1000	8	MLA	h	104	150	68	0111 1000	8	MSA
)	41	051	29	0010 1001	9	MLA	i	105	151	69	0111 1001	9	MSA
*	42	052	2A	0010 1010	10	MLA	j	106	152	6A	0111 1010	10	MSA
+	43	053	2B	0010 1011	11	MLA	k	107	153	6B	0111 1011	11	MSA
,	44	054	2C	0010 1100	12	MLA	l	108	154	6C	0111 1100	12	MSA
-	45	055	2D	0010 1101	13	MLA	m	109	155	6D	0111 1101	13	MSA
.	46	056	2E	0010 1110	14	MLA	n	110	156	6E	0111 1110	14	MSA
/	47	057	2F	0010 1111	15	MLA	o	111	157	6F	0111 1111	15	MSA
0	48	060	30	0011 0000	16	MLA	p	112	160	70	0111 0000	16	MSA
1	49	061	31	0011 0001	17	MLA	q	113	161	71	0111 0001	17	MSA
2	50	062	32	0011 0010	18	MLA	r	114	162	72	0111 0010	18	MSA
3	51	063	33	0011 0011	19	MLA	s	115	163	73	0111 0011	19	MSA
4	52	064	34	0011 0100	20	MLA	t	116	164	74	0111 0100	20	MSA
5	53	065	35	0011 0101	21	MLA	u	117	165	75	0111 0101	21	MSA
6	54	066	36	0011 0110	22	MLA	v	118	166	76	0111 0110	22	MSA
7	55	067	37	0011 0111	23	MLA	w	119	167	77	0111 0111	23	MSA
8	56	070	38	0011 1000	24	MLA	x	120	170	78	0111 1000	24	MSA
9	57	071	39	0011 1001	25	MLA	y	121	171	79	0111 1001	25	MSA
:	58	072	3A	0011 1010	26	MLA	z	122	172	7A	0111 1010	26	MSA
;	59	073	3B	0011 1011	27	MLA	{	123	173	7B	0111 1011	27	MSA
<	60	074	3C	0011 1100	28	MLA		124	174	7C	0111 1100	28	MSA
=	61	075	3D	0011 1101	29	MLA	}	125	175	7D	0111 1101	29	MSA
>	62	076	3E	0011 1110	30	MLA	~	126	176	7E	0111 1110	30	MSA
?	63	077	3F	0011 1111	31	UNL		127	177	7F	0111 1111	31	UNS



## **Appendix C**

# **Symbolic Names of Calibration Constants**

Name	Description
D3P	11V range, positive zero
D3M	11V range, negative zero
D4P	22V range, positive zero
D4M	22V range, negative zero
KV6	6.5V reference true value
KV13	13V reference true value
BV6	6.5V buffered reference value
BV13	13V buffered reference value
KDAC	DAC channel ratio
KADC	A/D scale constant (gain of one range)
DACLIN	DAC linearity
APDC	220V dc cal attenuator constant
KZAL	Switch Matrix zero amp gain (low setting)
ZA220	220 mV attenuator - zero amp combo offset
ZA2V	2V attenuator - zero amp combo offset
D1P	220 mV range offset
D1G	220 mV range gain
D2P	2.2V range offset
D2G	2.2V range gain
D3G	11V range positive gain
D3N	11V range negative gain

D4G	22V range positive gain
Name	Description
D4N	22V range negative gain
D5P	220V range zero offset
D5G	220V range gain
D6P	1100V range zero offset
D6G	1100V range gain
KRMS	AC V sense return buffer offset
OSUP	Upward 15-bit dac hysteresis offset
OSDN	Downward 15-bit dac hysteresis offset
A1G	2.2 mV range gain
A1S	2.2 mV range standing wave ratio correction
A2G	22 mV range gain
A2S	22 mV range standing wave ratio correction
A3G	220 mV range gain
A3S	220 mV range standing wave ratio correction
A4G	2.2V range gain
A4S	2.2V range standing wave ratio correction
A4D	2.2V range 8-bit dac constant
A4F1	2.2V range, flatness correction, 20 kHz
A4F2	Same, 50 kHz
A4F3	Same, 100 kHz
A4F4	Same, 119.99 kHz
A4F5	Same, 120 kHz
A4F6	Same, 200 kHz
A4F7	Same, 300 kHz
A4F8	Same, 400 kHz
A4F9	Same, 500 kHz
A4FA	Same, 600 kHz
A4FB	Same, 700 kHz
A4FC	Same, 800 kHz
A4FD	Same, 900 kHz
A4FE	Same, 1 MHz
A4FF	Same, 1.1 MHz

A4FG	Same, 1.1999 MHz
A4FH	10 Hz linearity correction
Name	Description
A4FI	1000V dc gain adjustment
A4C1	2.2V range, first convergence correction, 10 Hz
A4C2	Same, 1 kHz
A4C3	Same, 5 kHz
A4C4	Same, 20 kHz
A4C5	Same, 50 kHz
A4C6	Same, 70 kHz
A4C7	Same, 100 kHz
A4C8	Same, 119.99 kHz
A4C9	2.2V range, first convergence correction, 200 kHz
A4CA	Same, 300 kHz
A4CB	Same, 400 kHz
A4CC	Same, 500 kHz
A4CD	Same, 600 kHz
A4CE	Same, 700 kHz
A4CF	Same, 800 kHz
A4CG	Same, 900 kHz
A4CH	Same, 1 MHz
A4CI	Same, 1.1 MHz
A4CJ	Same, 1.1999 MHz
A4V1	2.2V range, first 1/V convergence correction, 10 Hz
A4V2	Same, 1 kHz
A4V3	Same, 5 kHz
A4V4	Same, 20 kHz
A4V5	Same, 50 kHz
A4V6	Same, 70 kHz
A4V7	Same, 100 kHz
A4V8	Same, 119.99 kHz
A4V9	Same, 200 kHz
A4VA	Same, 300 kHz
A4VB	Same, 400 kHz

A4VC	Same, 500 kHz
A4VD	Same, 600 kHz
A4VE	Same, 700 kHz
Name	Description
A4VF	Same, 800 kHz
A4VG	Same, 900 kHz
A4VH	Same, 1 MHz
A4VI	Same, 1.1 MHz
A4VJ	Same, 1.1999 MHz
A5G	22V range gain
A5S	22V range standing wave ratio correction
A5D	22V range 8-bit dac constant
A5F1	22V range, first flatness correction, 20 kHz
A5F2	Same, 50 kHz
A5F3	Same, 100 kHz
A5F4	Same, 119.99 kHz
A5F5	Same, 120 kHz
A5F6	Same, 200 kHz
A5F7	Same, 300 kHz
A5F8	Same, 400 kHz
A5F9	Same, 500 kHz
A5FA	Same, 600 kHz
A5FB	Same, 700 kHz
A5FC	Same, 800 kHz
A5FD	Same, 900 kHz
A5FE	Same, 1 MHz
A5FF	Same, 1.1 MHz
A5FG	Same, 1.1999 MHz
A5FH	220V ac gain adjustments
A5FI	22 mV ac gain adjustment
A5C1	22V range, first convergence correction
A5C2	Same, 1 kHz
A5C3	Same, 5 kHz
A5C4	Same, 20 kHz

A5C5	Same, 50 kHz
A5C6	Same, 70 kHz
A5C7	Same, 100 kHz
A5C8	Same, 119.99 kHz
Name	Description
A5C9	Same, 200 kHz
A5CA	Same, 300 kHz
A5CB	Same, 400 kHz
A5CC	Same, 500 kHz
A5CD	Same, 600 kHz
A5CE	Same, 700 kHz
A5CF	Same, 800 kHz
A5CG	22V range, first flatness correction, 900 kHz
A5CH	Same, 1 MHz
A5CI	Same, 1.1 MHz
A5CJ	Same, 1.1999 MHz
A5V1	22V range, first 1/V convergence correction
A5V2	Same, 1 kHz
A5V3	Same, 5 kHz
A5V4	Same, 20 kHz
A5V5	Same, 50 kHz
A5V6	Same, 70 kHz
A5V7	Same, 100 kHz
A5V8	Same, 119.99 kHz
A5V9	Same, 200 kHz
A5VA	Same, 300 kHz
A5VB	Same, 400 kHz
A5VC	Same, 500 kHz
A5VD	Same, 600 kHz
A5VE	Same, 700 kHz
A5VF	Same, 800 kHz
A5VG	Same, 900 kHz
A5VH	Same, 1 MHz
A5VI	Same, 1.1 MHz

A5VJ	Same, 1.1999 MHz
A6G	220V range basic gain
A6S	220V range standing wave ratio correction
A6D1	220V range, first freq. dependent 8-bit dac constant, 10 kHz
A6D2	Same, 50 kHz
Name	Description
A6D3	Same, 120 kHz
A6D4	Same, 300 kHz
A6D5	Same, 500 kHz
A6D6	Same, 600 kHz
A6D7	Same, 700 kHz
A6D8	Same, 800 kHz
A6D9	220V range, first freq. dependent 8-bit dac constant, 900 kHz
A6DA	Same, 1 MHz
A6F1	220V range, first flatness correction, 5 kHz
A6F2	Same, 10 kHz
A6F3	Same, 20 kHz
A6F4	Same, 50 kHz
A6F5	Same, 100 kHz
A6F6	Same, 119.99 kHz
A6F7	Same, 120 kHz
A6F8	Same, 200 kHz
A6F9	Same, 300 kHz
A6FA	Same, 400 kHz
A6FB	Same, 500 kHz
A6FC	Same, 600 kHz
A6FD	Same, 700 kHz
A6FE	Same, 800 kHz
A6FF	Same, 900 kHz
A6FG	Same, 1 MHz
A6FH	220V ac flatness cutoff frequency
A6FI	220 mV dc gain adjustment
A6FJ	Spare
A6FK	Spare

A6FL	Spare
A7G	1100V range gain
A7F1	1100V range, first flatness correction, 300 Hz
A7F2	Same, 500 Hz
A7F3	Same, 700 Hz
A7F4	Same, 1 kHz
Name	Description
A7F5	Spare
A7F6	Spare
I1Z	220 $\mu$ A range zero
I1G	220 $\mu$ A range gain
I2Z	2.2 mA range zero
I2G	2.2 mA range gain
I3Z	22 mA range zero
I3G	22 mA range gain
I4Z	220 mA range zero
I4G	220 mA range gain
I5Z	2.2A range zero
I5G	2.2A range gain
IGME	Measurement at bottom of resistor during gain cal
I1F1	220 $\mu$ A ac, 500 Hz
I1F2	Same, 1 kHz
I1F3	Same, 2 kHz
I1F4	Same, 5 kHz
I1F5	Same, 7 kHz
I1F6	Same, 10 kHz
I1F7	Spare
I1F8	Spare
I2F1	2.2 mA ac, 500 Hz
I2F2	Same, 1 kHz
I2F3	Same, 2 kHz
I2F4	Same, 5 kHz
I2F5	Same, 7 kHz
I2F6	Same, 10 kHz

**5700A/5720A Series II***Operators Manual*

I2F7	Spare
I2F8	220 $\mu$ A flatness correction
I3F1	22 mA ac, 500 Hz
I3F2	Same, 1 kHz
I3F3	Same, 2 kHz
I3F4	Same, 5 kHz
I3F5	Same, 7 kHz
Name	Description
I3F6	Same, 10 kHz
I3F7	Spare
I3F8	Spare
I4F1	220 mA ac, 500 Hz
I4F2	220 mA ac, 1 kHz
I4F3	Same, 2 kHz
I4F4	Same, 5 kHz
I4F5	Same, 7 kHz
I4F6	Same, 10 kHz
I4F7	Spare
I4F8	Spare
I5F1	2.2A ac, 500 Hz
I5F2	Same, 1 kHz
I5F3	Same, 2 kHz
I5F4	Same, 5 kHz
I5F5	Same, 7 kHz
I5F6	Same, 10 kHz
I5F7	Spare
I5F8	2.2A dc gain adjustment
IMZ	Current monitor circuit zero
IMAG	Current monitor circuit ac gain
IMDG	Current monitor circuit dc gain
RS10	10 k $\Omega$ standard true value (on Ohms Cal assembly)
R0	0 $\Omega$ true value
R1	1 $\Omega$ true value
R1_9	1.9 $\Omega$ true value

R10	10 $\Omega$ true value
R19	19 $\Omega$ true value
R100	100 $\Omega$ true value
R190	190 $\Omega$ true value
R1K	1 k $\Omega$ true value
R1_9K	1.9 k $\Omega$ true value
R10K	10 k $\Omega$ true value
R19K	19 k $\Omega$ true value
Name	Description
R100K	100 k $\Omega$ true value
R190K	190 k $\Omega$ true value
R1M	1 M $\Omega$ true value
R1_9M	1.9 M $\Omega$ true value
R10M	10 M $\Omega$ true value
R19M	19 M $\Omega$ true value
R100M	100 M $\Omega$ true value
RDIV10	Divider ratio Ohms Cal assembly to get 10V from 13V ref
RDIV5	Divider ratio Ohms Cal assembly to get 5V from 13V ref
RDIV2	Divider ratio Ohms Cal assembly to get 2V from 13V ref
RDIV_1	10k/90k divider on Ohms Cal assembly
ZERO_TEMP	Recorded temperature for zero calibration
ALL_TEMP	Recorded temperature main output calibration
G5205D	5205A gain, dc
G5205A	5205A gain, ac
G5220	5220A gain
W1G	1.1 mV wideband gain
W2G	3.3 mV wideband gain
W3G	11 mV wideband gain
W4G	33 mV wideband gain
W5G	110 mV wideband gain
W6G	330 mV wideband gain
W7G	1.1V wideband gain
W8G	3.5V wideband gain
WL1	Wideband thermal sensor correction constant #1

WL2	Wideband thermal sensor correction constant #2
WL3	Wideband thermal sensor buffer offset
WBAND_TEMP	Recorded temperature for wideband gains calibration
WF1	No attenuators wideband flatness correction, 1 kHz
WF2	Same, 12 kHz
WF3	Same, 100 kHz
WF4	Same, 500 kHz
WF5	Same, 1.1999 MHz
WF6	Same, 1.2 MHz
Name	Description
WF7	Same, 2 MHz
WF8	Same, 10 MHz
WF9	No attenuators wideband flatness correction, 20 MHz
WFA	Same, 30 MHz
WFB	Spare
WFC	Spare
W1F1	10 dB attenuator wideband flatness correction, 1 kHz
W1F2	Same, 12 kHz
W1F3	Same, 100 kHz
W1F4	Same, 500 kHz
W1F5	Same, 1.1999 MHz
W1F6	Same, 1.2 MHz
W1F7	Same, 2 MHz
W1F8	Same, 10 MHz
W1F9	Same, 20 MHz
W1FA	Same, 30 MHz
W1FB	Spare
W1FC	Spare
W2F1	20 dB attenuator wideband flatness correction, 1 kHz
W2F2	Same, 12 kHz
W2F3	Same, 100 kHz
W2F4	Same, 500 kHz
W2F5	Same, 1.1999 MHz
W2F6	Same, 1.2 MHz

W2F7	Same, 2 MHz
W2F8	Same, 10 MHz
W2F9	Same, 20 MHz
W2FA	Same, 30 MHz
W2FB	Spare
W2FC	Spare
W3F1	10 dB and 20 dB together wideband rf correction, 1 kHz
W3F2	Same, 10 MHz
W3F3	Same, 20 MHz
W3F4	Same, 30 MHz
<b>Name</b>	<b>Description</b>
W3F5	Spare
W3F6	Spare
W4F1	40 dB attenuator wideband flatness correction, 1 kHz
W4F2	Same, 12 kHz
W4F3	Same, 100 kHz
W4F4	Same, 500 kHz
W4F5	Same, 1.1999 MHz
W4F6	Same, 1.2 MHz
W4F7	Same, 2 MHz
W4F8	Same, 10 MHz
W4F9	Same, 20 MHz
W4FA	Same, 30 MHz
W4FB	Spare
W4FC	Spare
W5F1	10 dB and 40 dB together wideband rf correction, 1 kHz
W5F2	Same, 10 MHz
W5F3	Same, 20 MHz
W5F4	Same, 30 MHz
W5F5	Spare
W5F6	Spare
WB_FLAT_TEMP	Recorded temperature for wideband flatness calibration
TW1	Manual range adjust, 220 mV dc
TW2	Manual range adjust, 2.2V dc

**5700A/5720A Series II***Operators Manual*

---

TW3	Manual range adjust, 11V dc
TW4	Manual range adjust, 22V dc
TW5	Manual range adjust, 220V dc
TW6	Manual range adjust, 1100V dc
TW7	Manual range adjust, 1100V dc with 5205A
TW8	Manual range adjust, 2.2 mV ac
TW9	Manual range adjust, 22 mV ac
TW10	Manual range adjust, 220 mV ac
TW11	Manual range adjust, 2.2V ac
TW12	Manual range adjust, 22V ac
TW13	Manual range adjust, 220V ac

Name	Description
TW14	Manual range adjust, 1100V ac
TW15	Manual range adjust, 1100V ac with 5725A
TW16	Manual range adjust, 1100V ac with 5215A
TW17	Manual range adjust, 1100V ac with 5205A
TW18	Manual range adjust, 220 $\mu$ A dc
TW19	Manual range adjust, 2.2 mA dc
TW20	Manual range adjust, 22 mA dc
TW21	Manual range adjust, 220 mA dc
TW22	Manual range adjust, 2.2A dc
TW23	Manual range adjust, 11A dc with 5725A
TW24	Manual range adjust, 20A dc with 5220A
TW25	Manual range adjust, 220 $\mu$ A ac
TW26	Manual range adjust, 2.2 mA ac
TW27	Manual range adjust, 22 mA ac
TW28	Manual range adjust, 220 mA ac
TW29	Manual range adjust, 2.2A ac
TW30	Manual range adjust, 11A ac with 5725A
TW31	Manual range adjust, 20A ac with 5220A
TW32	Manual range adjust, 1.1 mV wideband ac
TW33	Manual range adjust, 3.3 mV wideband ac
TW34	Manual range adjust, 11 mV wideband ac
TW35	Manual range adjust, 33 mV wideband ac
TW36	Manual range adjust, 110 mV wideband ac
TW37	Manual range adjust, 330 mV wideband ac
TW38	Manual range adjust, 1.1V wideband ac
TW39	Manual range adjust, 3.5V wideband ac
TW40	Manual range adjust, 0 $\Omega$
TW41	Manual range adjust, 1 $\Omega$
TW42	Manual range adjust, 1.9 $\Omega$
TW43	Manual range adjust, 10 $\Omega$
TW44	Manual range adjust, 19 $\Omega$
TW45	Manual range adjust, 100 $\Omega$
TW46	Manual range adjust, 190 $\Omega$

Name	Description
TW47	Manual range adjust, 1 k $\Omega$
TW48	Manual range adjust, 1.9 k $\Omega$
TW49	Manual range adjust, 10 k $\Omega$
TW50	Manual range adjust, 19 k $\Omega$
TW51	Manual range adjust, 100 k $\Omega$
TW52	Manual range adjust, 190 k $\Omega$
TW53	Manual range adjust, 1 M $\Omega$
TW54	Manual range adjust, 1.9 M $\Omega$
TW55	Manual range adjust, 10 M $\Omega$
TW56	Manual range adjust, 19 M $\Omega$
TW57	Manual range adjust, 100 M $\Omega$
TW58	Spare
TW59	Spare
TW60	Spare
5725_SET	5725A set selector
ABG	1100V ac gain constant (5725A)
ABS	1100V ac standing wave ratio correction (5725A)
ABZ	1100A ac sense amp offset (5725A)
ABCAP	5725A capacitive dac setting
ABF1	5725A flatness constants, 1 kHz
ABF2	5725A flatness constants, 5 kHz
ABF3	5725A flatness constants, 10 kHz
ABF4	5725A flatness constants, 12 kHz
ABF5	5725A flatness constants, 15 kHz
ABF6	5725A flatness constants, 17 kHz
ABF7	5725A flatness constants, 20 kHz
ABF8	5725A flatness constants, 30 kHz
ABF9	5725A flatness constants, 30.01 kHz
ABFA	5725A flatness constants, 40 kHz
ABFB	5725A flatness constants, 50 kHz
ABFC	5725A flatness constants, 60 kHz
ABFD	5725A flatness constants, 70 kHz
ABFE	5725A flatness constants, 80 kHz

Name	Description
ABFF	5725A flatness constants, 90 kHz
ABFG	5725A flatness constants, 100 kHz
IDBG	10A dc gain constant (5725A)
IABG	10A ac gain constant (5725A)
IBZ	10A dc current zero (5725A)
DB2_0	Monitor dac value for 2.0V output
DB1_8	Monitor dac value for 1.8V output
CAL5725_TEMP	Recorded temperature for 5725A calibration



## **Appendix D**

# **Glossary**

### **adc (analog-to-digital converter)**

A device or circuit that converts an analog voltage to digital signals.

### **absolute uncertainty**

Uncertainty specifications that include the error contributions made by all equipment and standards used to calibrate the instrument. Absolute uncertainty is the number to compare with the UUT for determining test uncertainty ratio.

### **accuracy**

The degree to which the measured value of a quantity agrees with the true (correct) value of that quantity. Accuracy is the same as 1 minus the percent uncertainty. (See “uncertainty.”) For example, an instrument specified to +/-1% uncertainty is 99% accurate.

### **assert**

To cause a digital signal line to go into a logic true state.

### **af (audio frequency)**

The frequency range of human hearing; normally 15 - 20,000 Hz.

### **artifact standard**

An object that produces or embodies a physical quantity to be standardized, for example a Fluke 732B dc Voltage Reference Standard.

### **base units**

Units in the SI system that are dimensionally independent. All other units are derived from base units. The only base unit in electricity is the ampere.

### **buffer**

Refers to either an area of digital memory for temporary storage of data, or an amplifier stage before the final amplifier.

### **burden voltage**

The maximum sustainable voltage across the terminals of a load.

**calibration check**

A fast, simple, automated procedure to provide added confidence between calibration recalls, and data that can be used to develop a history of the calibrator's performance between calibrations. No changes are made to stored constants, and the internal check standards are used as the reference points instead of external standards as in the routine calibration procedure.

**calibrate**

To compare a measurement system or device of unknown accuracy to a measurement system or device of known and greater accuracy to detect or correct any variation from required performance of the unverified measurement system or device.

**calibration**

The comparison of a measurement system or device of unknown accuracy to a measurement system or device of known and greater accuracy to detect or correct any variation from required performance of the unverified measurement system or device.

**calibration constant**

A correction factor that is applied manually or automatically to correct the output or reading of an instrument.

**calibration curve**

A smooth curve drawn through a graph of calibration points.

**calibration interval**

The interval after which calibration must occur to maintain the performance of an instrument as stated in its specifications.

**calibration report**

A record of uncertainty and/or correction factors for an instrument as determined during calibration.

**calibrator**

A device that supplies outputs with a known uncertainty for use in checking the accuracy of measurement devices.

**check standard**

A device used solely to verify the integrity of another standard. For example in the 5700A/5720A Series II calibrator, one Fluke RMS sensor continuously monitors the output voltage while a second Fluke RMS sensor confirms the integrity of the first.

**characterization**

The development of a table of calibration constants or correction factors for use in correcting the output or reading of an instrument.

**common mode noise**

An undesired signal that exists between a device's terminals and ground. Common mode noise is at the same potential on both terminals of a device.

**compliance voltage**

The maximum voltage a constant-current source can supply.

**control chart**

A chart devised to monitor one or more processes in order to detect the excessive deviation from a desired value of a component or process.

**crest factor**

The ratio of the peak voltage to the rms voltage of a waveform (with the dc component removed).

**current guard**

A generator that drives the inner shield of a triaxial cable with a signal of the same amplitude and phase as a Calibrator's ac current output signal on the center conductor. The current guard shields the Calibrator's output signal from a capacitive leakage path to ground.

**dac (digital-to-analog converter)**

A device or circuit that converts a digital waveform to an analog voltage.

**dBm**

Power level expressed as decibels above or below 1 mW.

**derived units**

Units in the SI system that are derived from base units. Volts, ohms, and watts are derived from amperes and other base and derived units.

**distortion**

Undesired changes in the waveform of a signal. Harmonic distortion disturbs the original relationship between a frequency and other frequencies naturally related to it. Intermodulation distortion (imd) introduces new frequencies by the mixing of two or more original frequencies. Other forms of distortion are phase distortion and transient distortion.

**errors**

The different types of errors described in this glossary are: offset error, linearity error, random error, scale error, systematic errors, and transfer error. Each of these are defined in this glossary.

**flatness**

A measure of the variation of the actual output an ac voltage source at different frequency points when set to the same nominal output level. A flat voltage source exhibits very little error throughout its frequency range.

**floor**

The part of the uncertainty specification of an instrument that is typically a fixed offset plus noise. Floor can be expressed as units such as microvolts or counts of the least significant digit. For the calibrator, the floor specification is combined with fixed range errors in one term.

**full scale**

The maximum reading of a range of a meter, analog-to-digital converter, or other measurement device, or the maximum attainable output on a range of a calibrator.

**gain error**

Same as scale error. Scale or gain error results when the slope of the meter's response curve is not exactly 1. A meter with only gain error (no offset or linearity error), will read 0V with 0V applied, but something other than 10V with 10V applied.

**ground**

The voltage reference point in a circuit. Earth ground is a connection through a ground rod or other conductor to the earth, usually accessible through the ground conductor in an ac power receptacle.

**ground loops**

Undesirable currents induced when there is more than one chassis ground potential in a system of instruments. Ground loops can be minimized by connecting all instruments in a system to ground to one point.

**guard**

See "voltage guard" and "current guard."

**International System of Units**

Same as "SI System of Units"; the accepted system of units. See also "units", "base units", and "derived units."

**legal units**

The highest echelon in a system of units, for example the U.S. National Bureau of Standards volt.

**life-cycle cost**

The consideration of all elements contributing to the cost of an instrument throughout its useful life. This includes initial purchase cost, service and maintenance cost, and the cost of support equipment.

**linearity**

The relationship between two quantities when a change in the first quantity is directly proportional to a change in the second quantity.

**linearity error**

Linearity error occurs when when the response curve of a meter is not exactly a straight line. This type of error is measured by fixing two points on the response curve, drawing a line through the points, then measuring how far the curve deviates from the straight line at various points on the response curve.

**MAP (Measurement Assurance Program)**

A program for a measurement process. A MAP provides information to demonstrate that the total uncertainty of the measurements (data), including both random error and systematic components of error relative to national or other designated standards is quantified, and sufficiently small to meet requirements.

**MTBF (Mean Time Between Failures)**

The time interval in operating hours that can be expected between failure of equipment. MTBF can be calculated from direct observation or mathematically derived through extrapolation.

**MTTF (Mean Time to Fail)**

The time interval in operating hours that can be expected until the first failure of equipment. MTF can be calculated from direct observation or mathematically derived through extrapolation.

**MTTR (Mean Time to Repair)**

The average time in hours required to repair failed equipment.

**metrology**

The science of measurement, and its field of knowledge.

### minimum use specifications

A compilation of specifications that satisfies the calibration requirements of a measurement system or device. The minimum use specifications are usually determined by maintaining a specified test uncertainty ratio between the calibration equipment and the unit under test. The *5700A/5720A Series II Service Manual* contains a table of minimum use specifications for performing full verification.

### noise

A signal containing no useful information that is superimposed on a desired or expected signal.

### normal mode noise

An undesired signal that appears between the terminals of a device.

### offset error

Same as zero error. The reading shown on a meter when an input value of zero is applied is its offset or zero error.

### parameters

Independent variables in a measurement process such as temperature, humidity, test lead resistance, etc.

### precision

The degree of agreement among independent measurements of a quantity under the same conditions. (Same as “repeatability.”)

The precision of a measurement process is the coherence, or the closeness to the one result, of all measurement results. High precision, for example would result in a tight pattern of arrow hits on a target, without respect to where on the target the tight pattern falls.

### predictability

A measure of how accurately the output value of a device can be assumed after a known time following calibration. If a device is highly stable, it is also predictable. If a device is not highly stable, but its value changes at the same rate every time after calibration, its output has a higher degree of predictability than a device that exhibits random change.

### primary standard

A standard defined and maintained by some authority and used to calibrate all other secondary standards.

### process metrology

Tracking the accuracy drift of calibration and other equipment by applying statistical analysis to correction factors obtained during calibration.

**random error**

Any error which varies in an unpredictable manner in absolute value and in sign when measurements of the same value of a quantity are made under effectively identical conditions.

**range**

The stated upper end of a measurement device's span. Usually, however, a measurement device can measure quantities for a specified percentage overrange. (The absolute span including overrange capability is called "scale.") In the 5700A/5720A Series II, however, range and scale are identical.

**range calibration**

An optional calibration procedure available to enhance the 5700A/5720A Series II specifications by nulling the output to an external standard.

**reference amplifier**

DC voltage references developed for the 5700A/5720A Series II. These are 6.5V hybrid devices consisting of a zener diode and a transistor on a heated substrate. These reference amplifiers exhibit extremely low uncertainty and drift, and are superior to zener diode or temperature-compensated zener diode voltage references.

**reference standard**

The highest-echelon standard in a laboratory; the standard that is used to maintain working standards that are used in routine calibration and comparison procedures.

**relative uncertainty**

5700A/5720A Series II uncertainty specifications that exclude the effects of external dividers and standards, for use when range constants are adjusted. Relative uncertainty includes only the stability, temperature coefficient, noise, and linearity specifications of the calibrator itself.

**reliability**

A measure of the "uptime" of an instrument.

**repeatability**

The degree of agreement among independent measurements of a quantity under the same conditions. (Same as "precision.")

**resistance**

A property of a conductor that determines the amount of current that will flow when a given amount of voltage exists across the conductor. Resistance is measured in ohms. One ohm is the resistance through which one volt of potential will cause one ampere of current to flow.

### **resolution**

The smallest change in quantity that can be detected by a measurement system or device. For a given parameter, resolution is the smallest increment that can be measured, generated or displayed.

### **rf (radio frequency)**

The frequency range of radio waves; ranging from 150 kHz up to the infrared range.

### **rms (root-mean-square)**

The value assigned to an ac voltage or current that results in the same power dissipation in a resistance as a dc current or voltage of the same value.

### **rms sensor**

A device that converts ac voltage to dc voltage with great accuracy. RMS sensors operate by measuring the heat generated by a voltage through a known resistance (i.e., power); therefore, they sense true rms voltage.

### **scale**

The absolute span of the reading range of a measurement device including overrange capability.

### **scale error**

Same as gain error. Scale or gain error results when the slope of the meter's response curve is not exactly 1. A meter with only scale error (no offset or linearity error), will read 0V with 0V applied, but something other than 10V with 10V applied.

### **secondary standard**

A standard maintained by comparison against a primary standard.

### **sensitivity**

The degree of response of a measuring device to the change in input quantity, or a figure of merit that expresses the ability of a measurement system or device to respond to an input quantity.

### **shield**

A grounded covering device designed to protect a circuit or cable from electromagnetic interference.

### **SI System of Units**

The accepted International System of Units. See also "units", "base units", and "derived units."

**specifications**

A precise statement of the set of requirements satisfied by a measurement system or device.

**stability**

A measure of the freedom from drift in value over time and over changes in other variables such as temperature. Note that stability is not the same as uncertainty.

**standard**

A device that is used as an exact value for reference and comparison.

**standard cell**

A primary cell that serves as a standard of voltage. The term “standard cell” often refers to a “Weston normal cell”, which is a wet cell with a mercury anode, a cadmium mercury amalgam cathode, and a cadmium sulfate solution as the electrolyte.

**systematic errors**

Errors in repeated measurement results that remain constant or vary in a predictable way.

**temperature coefficient**

A factor per °C deviation from a nominal value or range that the uncertainty of an instrument increases. This specification is necessary to account for the thermal coefficients in a calibrator’s analog circuitry.

**test uncertainty ratio**

The numerical ratio of the uncertainty of the measurement system or device being calibrated to the uncertainty of the measurement system or device used as the calibrator. (Also called “test accuracy ratio.”)

**thermal emf**

The voltage generated when two dissimilar metals joined together are heated.

**traceability**

The ability to relate individual measurement results to national standards or nationally accepted measurement systems through an unbroken chain of comparisons, i.e., a calibration “audit trail.”

Measurements, measurement systems or devices have traceability to the designated standards if and only if scientifically rigorous evidence is produced on a continuing basis to show that the measurement process is producing measurement results for which the total measurement uncertainty relative to national or other designated standards is qualified.

### **transfer error**

The sum of all new errors induced during the process of comparing one quantity against another.

### **transfer standard**

Any working standard used to compare a measurement process, system or device at one location or level with another measurement process, system, or device at another location or level.

### **transport standard**

A transfer standard that is rugged enough to allow shipment by common carrier to another location.

### **true value**

Also called legal value, the accepted, consensus, (i.e., the correct value of the quantity being measured).

### **uncertainty**

The maximum difference between the accepted, consensus, or true value and the measured value of a quantity. Uncertainty is normally expressed in units of ppm (parts per million) or as a percentage. (Accuracy is the same as 1 - % uncertainty.)

### **units**

Symbols or names that define the measured quantities. Examples of units are: V, mV, A, kW, and dBm. See also "SI System of Units."

### **UUT (Unit Under Test)**

An abbreviated name for an instrument that is being tested or calibrated.

### **volt**

The unit of emf (electromotive force) or electrical potential in the SI system of units. One volt is the difference of electrical potential between two points on a conductor carrying one ampere of current, when the power being dissipated between these two points is equal to one watt.

### **watt**

The unit of power in the SI system of units. One watt is the power required to do work at the rate of one joule/second. In terms of volts and ohms, one watt is the power dissipated by one ampere flowing through a 1 $\Omega$  load.

### **wideband**

AC voltage at frequencies up to and including the radio frequency spectrum.

**verification**

Checking the functional performance and uncertainty of an instrument or standard without making adjustments to it or changing its calibration constants.

**voltage guard**

A floating shield around voltage measurement circuitry inside an instrument. The voltage guard provides a low-impedance path to ground for common-mode noise and ground currents, thereby eliminating errors introduced by such interference.

**working standard**

A standard that is used in routine calibration and comparison procedures in the laboratory, and is maintained by comparison to reference standards.

**zero error**

Same as offset error. The reading shown on a meter when an input value of zero is applied is its zero or offset error.



# Index

## —\*—

- \*CLS remote command, 5-26
- \*ESE remote command, 5-27
- \*ESE? remote command, 5-28
- \*ESR? remote command, 5-28
- \*IDN? remote command, 5-30
- \*LRN? remote command, 5-32
- \*OPC remote command, 5-33, 5-66
- \*OPC? remote command, 5-33, 5-66
- \*OPT? remote command, 5-34
- \*PUD remote command, 5-35
- \*PUD? remote command, 5-36
- \*RST remote command, 5-37
- \*SRE remote command, 5-39
- \*SRE? remote command, 5-39
- \*STB? remote command, 5-40
- \*TST? remote command, 5-40
- \*WAI remote command, 5-41, 5-66

## —5—

- 5100B Emulation Mode
  - Current Output Location, 5-70
  - Differences in the Ohms Function, 5-70
  - Entering Emulation Mode, 5-68
  - Exiting Emulation Mode, 5-69
  - Local to Remote Transitions, 5-69
  - Ohms Remote Program Modifications, 5-71
  - The 5720's Display During Emulation, 5-69
- 5100B Emulation Mode, 5-69
- 5200A Emulation Mode, 5-72
  - Entering Emulation Mode, 5-68
  - Exiting Emulation Mode, 5-69
  - Overload Conditions, 5-74
  - Phase Lock Errors, 5-74
  - Programming External Sensing, 5-74

- Rounding Numeric Entries, 5-73
- Settling Times, 5-73
- The 5720's Display During Emulation, 5-69
- Using Hard Switches to change Operating Modes, 5-72
- Voltage and Frequency Ranges, 5-72
- 5725A AMPLIFIER Connector, 3-12
- 5725A Amplifier Output, 4-37

## —7—

- 732B Direct Voltage Reference Standard, 1-6, 8-4
- 732B-200 Direct Volt Maintenance Program (U.S.A. Only), 1-7
- 742A Series Resistance Standards, 1-7
- 742A Series Standard Resistors, 8-5

## —A—

- AC Current Output, 4-28
- AC PWR INPUT Connector, 3-14
- AC Voltage output, 4-25
- Accessing the Fuse, 2-5
- Accessories, 8-3
- DC Voltage Reference Standard (732B), 8-4
- Low Thermal EMF Test Leads, 8-4
- Rack Mount Kits (Y5737 and Y5735), 8-4
- Resistance Standards
  - (742A - 1 and 742A-10k), 8-5
- RS-232C Null-Modem Cables (Y1702 and Y1703), 8-4
- Shielded IEEE-488 interface cables (Y8021, Y8022, and Y8023), 8-4
- Add/Subtract key, 3-9
- ADJOUT? remote command, 5-17
- Air filter, 2-4
- Amperes key, 3-8

Ampl/Freq key, 3-6  
Amplifiers. See Auxiliary Amplifier  
Applications, sample, 4-51  
Arrow key, 3-6  
Arrow keys, 4-38  
AUX CURRENT OUTPUT Binding Post, 3-10  
Auxiliary Amplifiers, 1-5, 2-8, 4-36, 8-5  
5725A Amplifier, 1-6

## —B—

Backup Battery, 4-9  
Binding, 4-13  
Binding Post  
Chassis Ground, 3-14  
Current Guard, 3-12  
GND, 3-10  
OUTPUT, 3-12  
OUTPUT, 3-10  
Rear panel, 3-12  
SENSE, 3-12  
SENSE, 3-10  
Voltage Guard, 3-12  
Voltage Guard, 3-10  
Binding Post Selection, 2-8  
Boost key, 3-6  
BOOST key, 4-36  
BTYPE remote command, 5-17  
BTYPE? remote command, 5-18  
Bus Communication Overview, 5-55

## —C—

Cable Connection Instructions, 4-16  
Cable Recommendations, 4-13  
CAL\_ADJ remote command, 5-18  
CAL\_CHK remote command, 5-18  
CAL\_CLST? remote command, 5-18  
CAL\_CONF remote command, 5-19  
CAL\_CONF? remote command, 5-19  
CAL\_CONST? remote command, 5-19  
CAL\_DATE? remote command, 5-19  
CAL\_DAYS? remote command, 5-19  
CAL\_INTV remote command, 5-20  
CAL\_INTV? remote command, 5-20  
CAL\_PR remote command, 5-20  
CAL\_REF remote command, 5-20  
CAL\_RNG remote command, 5-21  
CAL\_RPT? remote command, 5-21  
CAL\_SHIFT? remote command, 5-22  
CAL\_SLST? remote command, 5-23  
CAL\_STORE remote command, 5-23  
CAL\_TEMP remote command, 5-24  
CAL\_TEMP? remote command, 5-24  
CAL\_WBFLAT remote command, 5-24  
CAL\_WBGAIN remote command, 5-25  
CAL\_ZERO remote command, 5-25

Calculation, dBm, 4-25, 4-33  
Calibrating 70 Series DMM  
Cables, 4-52  
Calibrating 70 Series DMM  
Guarding, 4-52  
Calibrating a 70 Series DMM, 4-51  
Calibrating the Meter, 4-54  
Testing the Meter, 4-53  
Calibrating a 70 Series DMM  
Sensing, 4-52  
Calibrating an 8840A Series Digital  
Multimeter, 4-56  
Calibrating an 8840A Series DMM  
A/D Calibration, 4-59  
Basic Calibration Procedure, 4-58  
Calibration Setup Procedure, 4-58  
Guarding, 4-56  
High Frequency AC Calibration, 4-62  
Offset and Gain Calibration, 4-60  
Sensing, 4-58  
Calibrating the 5700A/5720A Series II  
Calibration Check, 1-11  
Calibration Process, 1-10  
Calibration Reports, 1-10  
Establishment of Traceability, 1-10  
Performance history, developing, 1-11  
Range Calibration, 1-11  
Calibrating the 5700A/5720A Series II, 1-8  
Calibrating to external standards, 7-6  
calibration procedure, 7-8  
calibration requirements, 7-7  
Calibration, 7-6  
DC Zeroes, 1-11  
range, 7-14  
Wideband AC Module (Option 5700A-03), 7-18  
Calibration Check, 7-21  
CALIBRATION Switch, 3-13  
CHASSIS GROUND Binding Post, 3-14  
Checking the Calibrator's Uncertainty  
Specification, 4-38  
Cleaning  
air filter, 7-4  
exterior, 7-6  
Clear Entry (CE) key, 3-8  
Clearance, for installation, 2-4  
CLOCK remote command, 5-25  
Clock/Calendar, setting, 4-9  
CLOCK? remote command, 5-25  
Commands. See Remote Commands  
Compensation circuitry, two-wire lead  
drop, 4-32  
Components of the 5700A/5720A Series II, 1-8  
Configuration Data, 4-11  
Connecting the Calibrator to a UUT, 4-13  
Connecting to Line Power, 2-8  
Connections, alternative for UUT, 3-12

Connector  
 N type, 3-10  
 Connectors, 3-14, *Also See* Binding Posts  
 5725A Amplifier, 3-12  
 AC PWR INPUT, 3-14  
 IEEE-488, 3-13, 5-60  
 Phase Lock In BNC, 3-12  
 RS-232C, 3-13, 6-3  
 Variable Phase Out BNC, 3-12  
 WIDEBAND, 3-10  
 Connectors, also see binding posts  
 Recommendations, 4-13  
 Control Display, 3-4  
 Cooling Considerations, 2-4  
 CUR\_POST remote command, 5-26  
 CUR\_POST? remote command, 5-26  
 Current  
 Guard, when to use, 4-15  
 Limits, setting, 4-50  
 Output, setting, 4-22  
 Current Guard Binding Posts, 3-12  
 Current units key, 3-8

## —D—

Date, setting, 4-9  
 DATEFMT remote command, 5-26  
 DATEFMT? remote command, 5-26  
 dBm calculation, 4-25  
 dBm key, 3-8, 4-25  
 DBMOUT? remote command, 5-26  
 DC Current Output, 4-27  
 DC Voltage Output, 4-24  
 DC Voltage Reference Standard (732B), 1-6, 8-4  
 DC Zeros, 4-5  
 Executing, 4-5  
 Reminder, 4-5  
 DC Zeros Calibration, 1-11  
 DIAG remote command, 5-27  
 DIAGFLT remote command, 5-27  
 DIAGFLT? remote command, 5-27  
 Display  
 Control, 3-4  
 Output, 3-4  
 screen saver, 3-3  
 Divide by 10 key, 3-7, 4-40

## —E—

ECHO? remote command, 5-27  
 EEPROM, formatting, 4-7  
 Emulation Modes for 5100B and 5200A  
 Entering Emulation Mode, 5-68  
 Exiting Emulation Mode, 5-69  
 The 5720's Display During Emulation, 5-69

Emulation Modes for 5100B and 5200A  
 Calibrator. See also 5100B Emulation Mode  
 or 5200A Emulation Mode  
 Enter key, 3-8  
 Error Mode Operation, 4-38  
 /10 key, 4-40  
 Adjustment controls, output, 4-38  
 Arrow keys, 4-38  
 Entering Error Mode, 4-39  
 Error Mode Overview, 4-39  
 Exiting Error Mode, 4-39  
 New Reference, establishing, 4-39  
 Using Error Mode, 4-40  
 Error Types, 4-42  
 Combining the Error Types, 4-44  
 Linearity Error, 4-44  
 Offset Error, 4-42  
 Scale Error, 4-43  
 ETIME? remote command, 5-28  
 Event Status Register, 5-49  
 Bit Assignments for the ESR and ESE, 5-49  
 Loading the ESE, 5-50  
 Reading the ESR and ESE, 5-50  
 Ex Grd key, 3-5  
 Ex Sns, 3-4  
 EX SNS key, 4-15  
 Exhaust, 2-4  
 Exiting Error Mode, 4-39  
 EXPLAIN remote command, 5-28  
 External Sensing, when to use, 4-14  
 External Voltage Guard, when to use, 4-15  
 EXTGUARD remote command, 5-29  
 EXTSENSE remote command, 5-29

## —F—

F1 Fuseholder, 3-14  
 Fan Filter, 3-12  
 Fault Queue, 5-53  
 FAULT? remote command, 5-29  
 Features, 1-3  
 Filter, cleaning, 7-4  
 Filter, fan, 3-12  
 Format EEPROM menu, 4-7  
 Format EEPROM Menu, 4-7  
 FORMAT remote command, 5-29  
 Four-Wire vs Two-Wire Resistance  
 Connections, 4-32  
 Frequency units key, 3-8  
 Front Panel Features, 3-3, 3-4  
 Function keys, output, 3-8  
 Functional Elements Of Commands, 5-56  
 Fuse Rating Label, 3-14  
 Fuse Replacement, 2-5  
 Fuse, accessing, 7-4  
 Fuseholder, 3-14

**—G—**

GAL remote command, 5-29  
GND Binding Post, 3-10  
Guarding, 4-15

**—H—**

Hazard, Shock, Safety Summary Sheet, 4-4  
HI Output Binding Post, 3-10  
Hz key, 3-8

**—I—**

IEEE-488 Connector, 3-13  
IEEE-488 Interface, 5-4  
Configuration, 5-54  
Connector, 5-60  
IEEE-488 Interface Cables (Y8021, Y8022, and Y8023), 8-4  
INCR remote command, 5-30  
Input Buffer Operation, remote control, 5-10  
Inspection, 2-3  
Installing  
Auxiliary Amplifiers, 2-8  
the 5700A/5720A Series II, 2-4  
Instruction Manuals. See Manuals, additional  
Instrument Setup, 4-7  
Instrument Status Change Enable Register, 5-51  
Bit Assignments for the ISR, ISCR, and ISCE, 5-51  
Loading the ISCE, 5-52  
Reading the ISR, ISCR, and ISCE, 5-52  
Instrument Status Change Register, 5-51  
Bit Assignments for the ISR, ISCR, and ISCE, 5-51  
Reading the ISR, ISCR, and ISCE, 5-52  
Instrument Status Register, 5-51  
Bit Assignments for the ISR, ISCR, and ISCE, 5-51  
Reading the ISR, ISCR, and ISCE, 5-52  
Interface Cables  
Null-Modem Cables, RS-232C (Y1702 and Y1703), 8-4  
Shielded IEEE-488 (Y8021, Y8022, and Y8023), 8-4  
Interface Messages, 5-58  
Interface, IEEE-488, 5-4  
Interface, RS-232C, 6-3  
Internal Clock/Calendar, setting, 4-9  
ISCE remote command, 5-30  
ISCE? remote command, 5-30  
ISCR? remote command, 5-31  
ISR? remote command, 5-31

**—K—**

Keypad, numeric, 3-9

Keys  
add/subtract, 3-9  
amperes, 3-8  
Ampl/Freq, 3-6  
arrow, 3-6  
Boost, 3-6  
Clear Entry (CE), 3-8  
dBm, 3-8  
divide by 10, 3-7  
Enter, 3-8  
Ex Grd, 3-5  
Ex Sns, 3-4  
Hz, 3-8  
kilo, 3-9  
Limit, 3-7  
mega, 3-9  
micro, 3-9  
milli, 3-9  
multiplier, 3-9  
multiply by 10, 3-7  
New ref, 3-8  
numeric keypad, 3-9  
Offset, 3-8  
ohms, 3-8  
Oper/Stby, 3-4  
output function, 3-8  
Prev Menu, 3-6  
Reset, 3-6  
Scale, 3-7  
Spec, 3-8  
volts, 3-8  
W Bnd, 3-5  
Knob, 3-6, 4-38

**—L—**

Label, line power and fuse rating, 2-7  
Lead drop compensation circuitry, 4-32  
Limit key, 3-7  
LIMIT remote command, 5-31  
LIMIT? remote command, 5-31  
Limits, setting, 4-50  
Line Power Cords, 2-6  
Line Voltage, 2-6  
Line voltage and fuse rating label, 2-7  
Line voltage selection switches, 2-7  
Line Voltage Switch, 3-14  
Linearity Checking Using Offset and Scale, 4-47  
Linearity Error, 4-44  
LO Output Binding Post, 3-10  
LOCAL serial remote command, 5-42  
LOCKOUT serial remote command, 5-42  
Low Thermal EMF Test Leads, 8-4  
Low thermal emf test leads (5440A-7002), 4-13

**—M—**

Maintenance  
 cleaning, 7-6  
 Manuals, additional, 1-4  
 Menu Tree, 3-14  
 Meter response vs. stimulus, 4-48  
 MULT remote command, 5-32  
 Multiplier Keys, 3-9  
 multiply by10 key, 3-7

**—N—**

N type connector, 3-10  
 New ref key, 3-8  
 NEW REF key, 4-63, 4-64  
 New reference, establishing, 4-39  
 NEWREF remote command, 5-32  
 Numeric Keypad, 3-9

**—O—**

Offset Error, 4-42  
 Offset key, 3-8  
 OFFSET key, 4-47  
 Offset Programming, 4-45  
 OFFSET remote command, 5-32  
 OFFSET? remote command, 5-32  
 OHMREF? remote command, 5-33  
 Ohms key, 3-8  
 OLDREF remote command, 5-33  
 ONTIME? remote command, 5-33  
 OPER remote command, 5-34  
 Oper/Stby key, 3-4  
 Operate and Standby Modes, 4-13  
 Operating State Transitions, 5-44  
 OUT remote command, 5-34  
 OUT? remote command, 5-34  
 OUT\_ERR? remote command, 5-34  
 OUTPUT Binding Post, 3-10  
 AUX CURRENT, 3-10  
 HI, 3-10  
 LO, 3-10  
 OUTPUT Binding Posts, 3-12  
 Output Display, 3-4  
 Output Function Keys, 3-8  
 Output Limits, setting, 4-50  
 Current Limits, setting, 4-50  
 Voltage Limits, setting, 4-50  
 Output, setting, 4-22  
 AC Current, 4-28  
 AC Voltage, 4-25  
 Auxiliary Amplifier, 4-37  
 DC Current, 4-27  
 DC Voltage, 4-24  
 Resistance, 4-30  
 Variable Phase, 4-34

Wideband AC Voltage(Option 5700A-03), 4-32

**—P—**

Parameters  
 Remote command, 5-8  
 Serial Communication, 6-4  
 Setup, 4-6  
 Performance History, developing, 1-11  
 Performing a Wideband Flatness Test, 4-63  
 Phase Controls menu, 4-34  
 Phase Lock In BNC Connector, 3-12  
 Phase locking to an external signal, 4-34  
 Phase Locking to an External Signal, 4-35  
 PHASE remote command, 5-35  
 PHASE? remote command, 5-35  
 PHASELCK remote command, 5-35  
 PHASESFT remote command, 5-35  
 Placement and Rack Mounting, 2-4  
 Power Switch, 3-6  
 Powering on the Calibrator, 4-3, 4-4  
 Prev Menu key, 3-6  
 Printing Calibration Reports, 6-6  
 About calibration reports, 1-10  
 Calibration Check Shift Results, 6-7  
 Calibration Shift Results, 6-6  
 Generating a Printout, 6-8  
 remote program to print a report, 5-61  
 Programming a Scale Factor, 4-46  
 Programming an Offset, 4-45

**—Q—**

Queue, fault, 5-53

**—R—**

Rack Mount Kits (Y5737 and Y5735), 2-4, 8-4  
 Range Calibration, 1-11, 7-14  
 Range Identifiers for Remote Commands, 5-42  
 RANGE? remote command, 5-36  
 RANGELCK remote command, 5-36  
 RCOMP remote command, 5-36  
 Reading the UUT Error  
 AC and DC Voltage and Current Output, 4-40  
 Resistance Output, 4-41  
 Rear Panel Binding Posts, 3-12  
 Rear Panel Features, 3-12  
*Reference Guides*, 1-4  
 REFOUT? remote command, 5-36  
 Remote Commands, 5-10  
 Coupled, 5-11  
 Extra Space Characters, 5-9  
 Ignored When not in Remote, 5-12  
 Long Term, 5-12  
 Multiple, 5-11  
 Overlapped, 5-12

- Parameter syntax rules, 5-7
  - Requiring the Calibration Switch to be set, 5-12
  - Response Message Syntax, 5-10
  - Sequential, 5-12
  - Syntax information, 5-7
  - Terminators, 5-9
  - Remote Control, IEEE-488 and common elements of RS-232, 5-4
  - Address Selection, 5-5
  - Bus Setup Procedure, 5-4
  - IEEE-488 Address Selection, 5-5
  - IEEE-488 Bus Restrictions, 5-4
  - Incoming Character Processing, 5-9
  - Input Buffer Operation, 5-10
  - Interface Messages Accepted, 5-59
  - Language Selection, 5-5
  - Port Setup, 5-5
  - Remote and Local State Transitions, 5-43
  - Remote State, 5-43
  - Remote with Lockout State, 5-44
  - Setup Procedure, 5-4
  - Terminators, 5-9
  - Remote Control, RS-232 Specific, 5-5
  - Exceptions for serial remote control, 5-7
  - Remote port setup, 5-6
  - Setup procedure, 5-6
  - Remote Program Examples, 5-61
  - \*WAI, using, 5-66
  - Calibration, 5-63
  - Calibration check, 5-64
  - DC Zeros, 5-62
  - OPC, using, 5-66
  - OPC?, using, 5-66
  - Printing main output calibration shift results, 5-61
  - Remote Calibration, 5-62
  - Verifying a meter, 5-62
  - Wideband AC Module (Option 5700A-03) Gain Calibration, 5-65
  - REMOTE serial remote command, 5-42
  - Reset key, 3-6
  - RESET key, 4-12
  - Resetting the Calibrator, 4-12
  - Resistance Output, 4-30
  - Resistance Value Table, 4-30
  - Resistance units key, 3-8
  - Resistors
    - standard, 742A series, 8-5
  - Rotary Knob, 3-6
  - RPT\_STR remote command, 5-37
  - RPT\_STR? remote command, 5-37
  - RS 232C Connector, 3-13
  - RS-232C Interface
    - Parameters, 6-4
  - Printing. *See* Printing Calibration Reports
  - Setup, 6-4
  - Specifications, 6-3
  - RS-232C Null-Modem Cables (Y1702 and Y1703), 8-4
- S—**
- Sample Applications, 4-51
  - SCAL\_ERR? remote command, 5-38
  - Scale Error, 4-43
  - Scale key, 3-7
  - SCALE key, 4-47
  - SCALE remote command, 5-37
  - SCALE? remote command, 5-37
  - Screen Saver, 3-3
  - Selecting Amplifiers, 4-10
  - Selecting Line Voltage, 2-6
  - Selecting Output Binding Posts, 2-8
  - SENSE Binding Post, 3-10
  - SENSE binding posts, 4-15
  - SENSE Binding Posts, 3-12
  - Sensing, external, when to use, 4-14
  - Serial Poll Status Byte, 5-47
  - Serial Port Remote Control. *See* Remote Control, RS-232C
  - Service Centers, 1-7
  - Service Information, 2-4
  - Setting up
    - IEEE-488 interface, 5-4
  - Installing the 5700A/5720A Series II, 2-4
  - RS-232C Serial Interface, 6-4
  - Setting Up
    - Menu, 4-6
    - Parameters, 4-6
    - Setup Menu, 4-6
  - Shipping Container, 2-3
  - Shock Hazard. Safety Summary Sheet, 4-4
  - Softkey Menu Tree, 3-14, 3-16
  - Softkeys, 3-6
  - SP\_EOF remote command, 5-38
  - SP\_EOF? remote command, 5-38
  - SP\_SET remote command, 5-38
  - SP\_SET? remote command, 5-39
  - SP\_TIME remote command, 5-39
  - SP\_TIME? remote command, 5-39
  - Spec Format Setup Menu, 4-8
  - Spec key, 3-8
  - SPEC key, 4-38
  - Special Functions Menu, 4-12
  - Specifications, 1-12
  - Confidence Levels, 1-12
  - uncertainty, checking, 4-38
  - Using, 1-12
  - Standard Equipment, 2-3
  - State transitions, operating, 5-43
  - STATE? remote command, 5-40
  - Status Register Summary, 5-45

Status, checking  
 Event Status Register, 5-49  
   Bit Assignments for the ESR  
   and ESE, 5-49  
   Loading the ESR and ESE, 5-50  
   Reading the ESR and ESE, 5-50  
 Instrument Status Change Enable Register  
   Bit Assignments for the ISR, ISCR, and  
   ISCE, 5-51  
   Loading the ISCE, 5-52  
   Reading the ISR, ISCR, and ISCE, 5-52  
 Instrument Status Change Register, 5-51  
   Bit Assignments for the ISR, ISCR, and  
   ISCE, 5-51  
   Reading the ISR, ISCR, and ISCE, 5-52  
 Instrument Status Register, 5-51  
   Bit Assignments for the ISR, ISCR, and  
   ISCE, 5-51  
   Reading the ISR, ISCR, and ISCE, 5-52  
 Instrument StatusChange Enable Register, 5-51  
 Serial Poll status byte, 5-47  
 Service Request Enable Register, 5-48  
 Service Request Line (SRQ), 5-48  
 SRE, loading, 5-48  
 STBY remote command, 5-40  
 STOP\_PR remote command, 5-40  
 Syntax, remote commands, 5-7

## —T—

Terminators, remote, 5-9  
 Time, 4-9  
 Troubleshooting, 2-4  
 Turning on the Calibrator, 4-3, 4-4  
 Two-Wire Compensation Circuitry, 4-32  
 Two-Wire Resistance Connection, 4-32

## —U—

UNCERT? remote command, 5-41  
 Uncertainty Specification, checking, 4-38  
 Uncertainty Specifications, displaying, 4-34  
 Unpacking, 2-3  
 Using an Auxiliary Amplifier, 4-36  
 UUT, Connections to the Calibrator, 4-12

## —V—

Variable Phase Out BNC Connector, 3-12  
 Variable Phase Output, 4-34  
 Phase Controls menu, 4-34  
 Quadrature points, 4-35  
 Voltage  
   Guard, when to use, 4-15  
   Limits, setting, 4-51  
   Line, 2-6  
   Setting the output, 4-22

Voltage Guard Binding Post, 3-10  
 Voltage Guard Binding Posts, 3-12  
 Voltage Selection Switches, 3-14  
 Voltage Switch, 3-14  
 Voltage units key, 3-8  
 Volts key, 3-8  
 VOUT? remote command, 5-41

## —W—

W Bnd key, 3-5  
 Warm Up, 4-4  
 WBAND remote command, 5-41  
 Wideband AC Module  
   dBm calculation, 4-33  
   Output, 4-32  
   use of W BND key, 4-32  
 Wideband AC Module (Option 5700A-03)  
   Calibrating, 7-18  
   Calibration, 1-7  
 Wideband AC Voltage Module (Option  
   5700A-03), 1-5  
 Wideband AC Voltage Output (Option  
   5700A-03), 4-32  
 WIDEBAND Connector, 3-10  
 Wideband voltmeter flatness test, 4-64

