

OPERATION AND MAINTENANCE MANUAL FOR SWR AUTOTESTERS AND BRIDGES

1. INTRODUCTION

This manual provides product descriptions and specifications for ANRITSU Series 59, 63, and 97 SWR Autotesters and Series 58, 60, 62, and 87 SWR Bridges. It also includes procedures for measuring the directivity of these components.

2. GENERAL DESCRIPTION

The SWR Autotesters and bridges (Figure 1) are broadband microwave measurement instruments. They are used with other test instruments for making fixed- and swept-frequency return loss (SWR) measurements over a wide range of radio frequencies. Return loss measurements are made to check the performance of systems, subsystems, and microwave components such as amplifiers, directional couplers, attenuators, filters, splitters, and terminations.

The ANRITSU SWR Autotesters and bridges are precision-balanced Wheatstone bridges. Except for the two 4-port comparison-type instruments (Models 59A50 and 58A50) that use an offset termination in the reference arm, every model has an internal precision reference termination included in one arm of its bridge. The major difference between the SWR Autotester and the SWR bridge is that the SWR Autotester contains a built-in RF detector.

3. PERFORMANCE SPECIFICATIONS

Performance specifications for SWR Autotesters are listed in Table 1; specifications for SWR bridges are listed in Table 2.

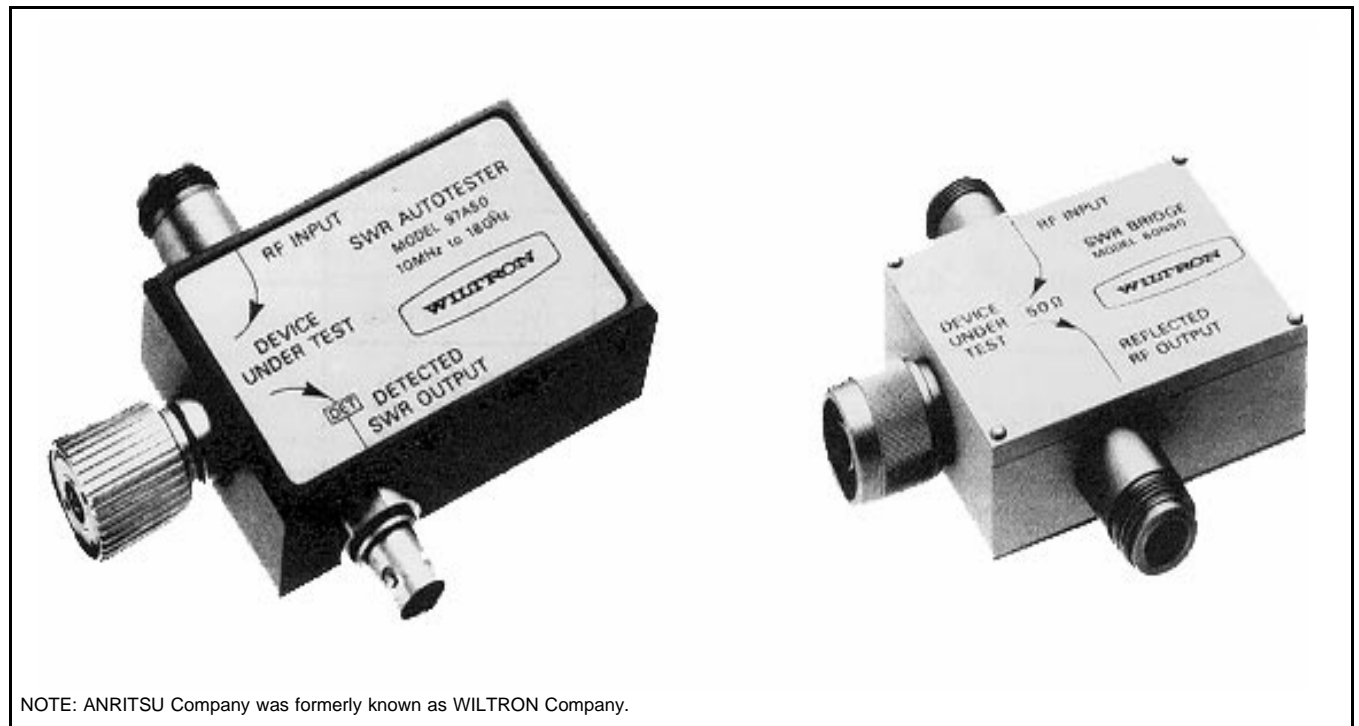

Figure 1. Typical ANRITSU SWR Autotester and SWR Bridge

Anritsu

Table 1. SWR Autotester Performance Specifications

Models	Directivity (dB)	Accuracy ^①	Input Z (ohms)	Test Port Connector	Physical
59 Series Comparison SWR Autotester, 10 MHz to 18 GHz					
59A50	36	0.01–8 GHz: $0.016 \pm 0.06\rho^2$ ^{②③} 8–18 GHz: $0.016 \pm 0.1\rho^2$	50	GPC–7	<i>Dimensions:</i> 7.6 x 5.1 x 2.8 cm (3 x 2 x 1 1/8 in.) plus connectors <i>Weight:</i> 340 g (12 oz)
63 Series SWR Autotesters, 10 MHz to 4 GHz					
63A50	40 ^④	$0.01 \pm 0.06\rho^2$	50	GPC7	<i>Dimensions:</i> 6.7 x 5.1 x 2.54 cm (2 5/8 x 2 x 1 in.) plus connectors <i>Weight:</i> 340 g (12 oz)
63N50				Type N Male	
63NF50				Type N Female	
97 Series SWR Autotesters, 10 MHz to 18GHz					
97A50	36	<u>0.01–8 GHz</u> <u>8–18 GHz</u> $0.016 \pm 0.06\rho^2$ $0.016 \pm 0.1\rho^2$	50	GPC–7	<i>Dimensions:</i> 7.6 x 5.1 x 2.8 cm (3 x 2 x 1 1/8 in.) plus connectors <i>Weight:</i> 340 g (12 oz)
97A50-1	40	$0.01 \pm 0.06\rho^2$ $0.01 \pm 0.1\rho^2$			
97S50	35	$0.018 \pm 0.08\rho^2$ $0.018 \pm 0.12\rho^2$		WSMA Male	
97SF50				WSMA Female	
97S50-1	38	$0.013 \pm 0.08\rho^2$ $0.013 \pm 0.12\rho^2$		WSMA Male	
97SF50-1				WSMA Female	
97N50	35	$0.018 \pm 0.08\rho^2$ $0.018 \pm 0.12\rho^2$		Type N Male	
97NF50				Type N Female	
97N50-1	38	$0.013 \pm 0.08\rho^2$ $0.013 \pm 0.12\rho^2$		Type N Male	
97NF50-1				Type N Female	
<u>All Models</u> Insertion Loss (from input to test port): 6.5 dB nominal Detector Output Polarity: Negative Output Time Constant: 2 μ s Maximum Power Input: 0.5 watts (+27 dBm) Input Connector: Type N Female Detector Output Connector: BNC Female					

① Where ρ is the reflection coefficient being measured. Accuracy includes the effects of test port reflections and directivity.

② When used with 28A50-1 Precision Termination. The effective directivity of the SWR Autotester can be increased to 60 dB by using the Ripple Extraction return loss measurement technique with the 18A50 Air Line and 29A50-20 Offset Termination.

③ See paragraph 4 for explanation of accuracy and other terms.

④ 46 dB directivity available as Option 1. Option 1 accuracy: $0.005 \pm 0.06\rho^2$.

Table 2. SWR Bridge Performance Specifications

Models	Directivity (dB)	Accuracy ^①	Input Z (ohms)	Test Port Connector	Physical
58 Series Comparison SWR Bridge, 2 to 18 GHz					
58A50	35	2–3 GHz: $0.018 \pm 0.32\rho^2$ ^② ^③ 3–4 GHz: $0.018 \pm 0.2\rho^2$ 4–18 GHz: $0.018 \pm 0.13\rho^2$	50	GPC–7	<i>Dimensions:</i> 6.7 x 5.1 x 2.2 cm (2 5/8 x 2 x 7/8 in.) plus connectors <i>Weight:</i> 340 g (12 Oz)
60 Series SWR Bridges, 5 MHz to 2 GHz					
60A50	40 ^④	$0.01 \pm 0.09\rho^2$	50	GPC–7	<i>Dimensions:</i> 6.7 x 5.1 x 2.54 cm (2 5/8 x 2 x 1 in.) plus connectors <i>Weight:</i> 340 g (12 oz)
60N50				Type N Male	
60NF50				Type N Female	
62 Series SWR Bridges, 10 MHz to 1GHz					
62N75 ^⑤	40	$0.01 \pm 0.12\rho^2$	75	Type N Male	<i>Dimensions:</i> 6.7 x 5.1 x 2.54 cm (2 5/8 x 2 x 1 in.) plus connectors <i>Weight:</i> 170 g (6 Oz)
62NF75				Type N Female	
62B75				BNC Male	
62BF75				BNC Female	
87 Series SWR Bridges, 2 to 18 GHz					
87A50	35	2–3 GHz: $0.018 \pm 0.32\rho^2$ 3–4 GHz: $0.018 \pm 0.2\rho^2$ 4–18 GHz: $0.018 \pm 0.13\rho^2$	50	GPC–7	<i>Dimensions:</i> 7.3 x 5.1 x 2.86 cm (2 5/8 x 2 x 1 1/8 in.) plus connectors <i>Weight:</i> 340 g (12 Oz)
87A50-1	38	2–3 GHz: $0.013 \pm 0.32\rho^2$ 3–4 GHz: $0.013 \pm 0.2\rho^2$ 4–18 GHz: $0.013 \pm 0.13\rho^2$			
<p>All Models</p> <p>Insertion Loss (from input to test port): 6.5 dB nominal Maximum Power Input: 0.5 watts (+27 dBm) Input Connector: Type N Female, stainless steel, except 67B and 67F Series that have BNC Female</p>					

① Where ρ is the reflection coefficient being measured. Accuracy includes the effects of test port reflections and directivity.

② When used with 28A50-1 Precision Termination. The effective directivity of the bridge can be increased to 60 dB by using the Ripple Extraction return loss measurement technique with the 18A50 Air Line and 29A50-20 Offset Termination.

③ See paragraph 4 for explanation of accuracy and other terms.

④ 46 dB directivity available as Option 1. Option 1 accuracy: $0.005 \pm 0.09\rho^2$.

⑤ 75 Ω Type N Female connectors will withstand occasional mating with 50 Ω connectors without damage.

4. EXPLANATION OF SWR AUTOTESTER AND BRIDGE SPECIFICATIONS

Certain key specification terms are explained below.

a. Accuracy. This three-element term defines the accuracy with which an SWR Autotester or bridge can make a reflected signal measurement. The three elements ($0.01 \pm 0.06 \rho^2$) are described below.

1st Element: (0.01) is the directivity of the SWR Autotester or bridge expressed as a reflection coefficient (40 dB for this example, see Table 6).

2nd and 3rd Elements: $\pm 0.06\rho^2$ is the depreciation in accuracy due to test port mismatch (impedance discontinuity). Element 2 (0.06) is the inherent test port mismatch expressed as a reflection coefficient. The 3rd element, ρ , is the reflection coefficient of the device under test (DUT). The entire expression describes the measurement uncertainty caused by the reflected signal being re-reflected by the test port mismatch.

b. Directivity. A figure of merit expressed in dB. This figure represents the ratio of the power levels as seen at the output port when (1) the test port signal is fully reflected, and (2) the test port is perfectly terminated.

c. Frequency Sensitivity. The maximum variation in output power/voltage that can be expected due to a change in frequency over the specified range when the input power is held constant

d. Output Time Constant. The amount of time required for the selected output pulse to either rise from the 10% to the 90% point or fall from the 90% to the 10% point on the waveform.

5. PRECAUTIONS

The SWR Autotesters and bridges are high-quality, precision laboratory instruments and should receive the same care and respect afforded such instruments. Complying with the following precautions will guarantee longer component life and less equipment downtime due to connector failure. Also, such compliance will ensure that SWR Autotester or bridge failures are not due to misuse or abuse—two failure modes not covered under the ANRITSU warranty.

a. Beware of Destructive Pin Depth on Mating Connectors. Before mating, measure the pin depth (Figure 2) of the device that will mate with the SWR Autotester or bridge, using a ANRITSU Pin Depth Gauge (Figure 3) or equivalent. Based on SWR Autotesters and bridges returned for repair, destructive pin depth of mating connectors is the major cause of failure in the field. (A destructive pin depth has a center pin that is too long in respect to the connector's reference plane.) When the SWR Autotester or bridge is mated with a connector having a destructive pin depth, damage will likely occur to the SWR Autotester or bridge.

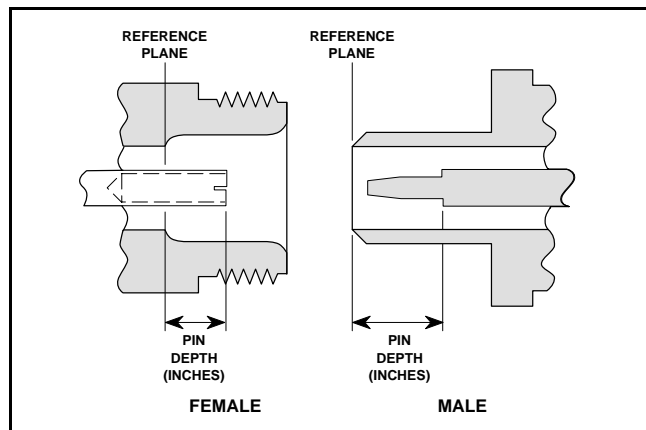

Figure 2. N Connector Pin Depth Definition

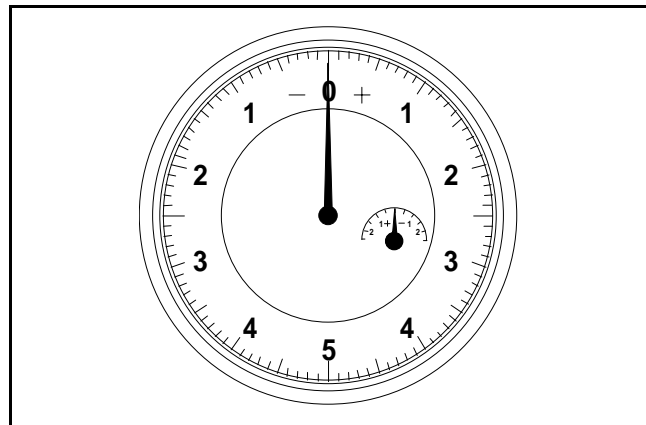

Figure 3. Pin Depth Gauge

The center pin of SWR Autotester or bridge connectors has a precision tolerance measured in mils (1/1000 inch). Connectors on test devices that mate with SWR Autotesters and bridges may not be precision types and may not have the proper depth. They must be measured before mating to ensure suitability. When gauging pin depth, if the SWR Autotester or bridge connector measures out of tolerance (Table 3) in the “+”

region of the gauge (Figure 3), the center pin is too long. Mating under this condition will likely damage the SWR Autotester or bridge connector. On the other hand, if the test device connector measures out of tolerance in the “-” region, the center pin is too short. While this will not cause any damage, it will result in a poor connection and a consequent degradation in performance.

b. Avoid Over Torquing Connectors. Over torquing connectors is destructive; it may damage the connector center pin. Finger-tight is usually sufficient, especially on Type N connectors. Should it be necessary to use a wrench to tighten SMA or WSMA connectors, use a torque wrench that breaks at 5 inch-pounds. As a general rule, *never use pliers to tighten connectors.*

c. Do Not Disturb Teflon Tuning Washers On Connector Center Pins. The center conductor on many SWR Autotester or bridge connectors contains a small teflon tuning washer located near the point of mating (interface) (Figure 4). This washer compensates for minor impedance discontinuities at the interface. The washer’s location is critical to the SWR Autotester or bridge’s performance. *Do not disturb it.*

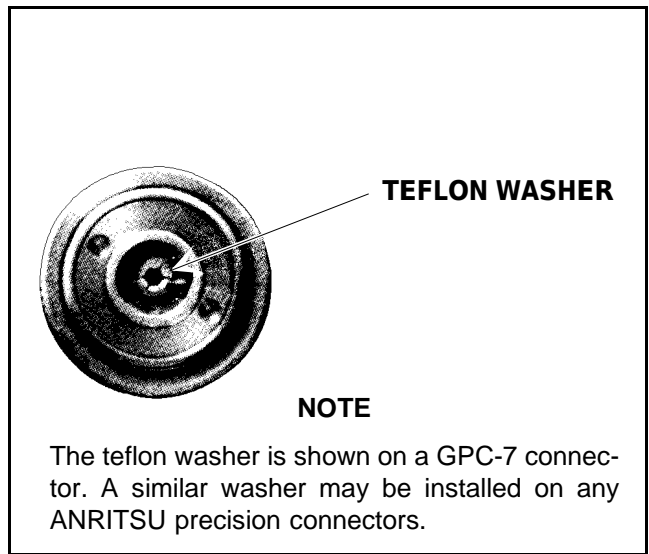

Figure 4. Tuning Washer on GPC-7 Connector

Table 3. Pin-Depth Tolerance, SWR Autotesters and Bridges

Series	Port/Conn. Type	Pin Depth (MILS)	Gauge Reading
58, 59, 87, 97 ¹	INPUT – NF	207 +0.000 –0.010	Same As Pin Depth
	OUTPUT – NF	207 +0.000 –0.010	
58, 59, 87, 97	TEST – A	+0.000 –0.003	
97	TEST – N	207 –0.000 +0.003	207 +0.000 –0.003
	TEST – NF	207 +0.000 –0.003	Same As Pin Depth
	TEST – S ²	–0.0025 –0.0035	
	TEST – SF ²	–0.0003 –0.0007	
60, 63	INPUT – NF	207 +0.000 –0.020	N/A
60	OUTPUT – NF		
60, 63	TEST – A	+0.000 –0.003	Same As Pin Depth
	TEST – N	207 +0.000 +0.003	207 +0.000 –0.003
	TEST – NF	207 +0.000 –0.003	Same As Pin Depth
62	INPUT – NF	207 +0.000 –0.020	
	OUTPUT – NF		
62	TEST – N	207 –0.000 +0.018	207 +0.000 –0.018
	TEST – NF	207 +0.000 –0.018	Same As Pin Depth

Legends and Notes

Typical Model Number:

97SF50

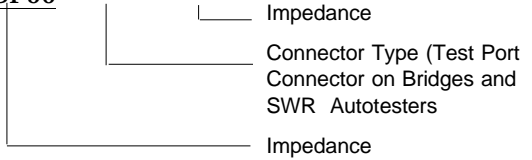

Connector Type Abbreviations:

- N = Type N male
- NF = Type N female
- A = GPC-7

d. Avoid Mechanical Shock. SWR Autotesters and bridges are designed to withstand years of normal bench handling. However, do not drop or otherwise treat them roughly. They are laboratory-quality devices, and like other such devices, they require careful handling.

e. Keep SWR Autotester or Bridge Connectors Clean. The precise geometry that makes the SWR Autotester's or bridge's high performance possible can be disturbed by dirt and other contaminants adhering to connector interfaces. When not in use, keep the SWR Autotester or bridge connectors covered. Refer to paragraph 8 for cleaning instructions.

6. PERFORMANCE VERIFICATION

Performance verification consists of measuring the directivity of the SWR Autotester or bridge and measuring connector pin depth.

7. DIRECTIVITY MEASUREMENTS.

Directivity measurements are frequency limited. For frequencies 2 GHz and above an air line technique is used to obtain a precise measurement; below 2 GHz where an air line is not effective, a go-no go test must be used.

Table 4 lists recommended test equipment for performing these measurements. Measurement procedures are given below.

Measuring the directivity of 97S50 and 97SF50 SWR Autotesters at 2 GHz and above requires use of a 19SF50 or 19S50 Air Line. The WSMA connectors on these components are designed to mate with SMA connectors. When mating two WSMA connectors, compensation washers are required. The only exceptions are the WSMA Open/Short and the sweep generator RF OUTPUT connector, which have been optimized for use with WSMA. An envelope containing six or more of these washers is packaged with each air line. Figure 9, beginning on page 12, provides a procedure for installing these washers.

Table 4. Recommended Test Equipment

Instrument	Required Characteristics	Recommended Model and Manufacturer
Scalar Network Analyzer System	<p><i>Sweep Generator</i> Leveled Output: ± 1.0 dB Frequency Range: 2 – 18 GHz</p> <p><i>Scalar Network Analyzer</i> Vertical Sensitivity: 0.5 dB/Div. Variable Offset Control</p>	ANRITSU 562 SNA and 68147B Synthesized Sweep Generator, with 560-10BX Cable OR ANRITSU 5447A Scalar Measurement System
Air Line	SWR: 1.002 (GPC-7 Connector) SWR: 1.006 (Type N/NF Connector) SWR: 1.006 (WSMA Connector)	ANRITSU 18 Series ANRITSU 19 Series
Termination	20 dB Offset	ANRITSU 29 Series
Precision Termination	<p><i>50 ± 0.5 Ohms</i> GPC-7 Test Port Connector Type N Test Port Connector WSMA Female Test Port Connector WSMA Male Test Port Connector</p> <p><i>75 ± 0.5 Ohms</i> Type N Test Port Connector BNC Test Port Connector</p>	ANRITSU: 28A50-1 26N50 28S50 28SF50 ANRITSU: 26N75 26B75

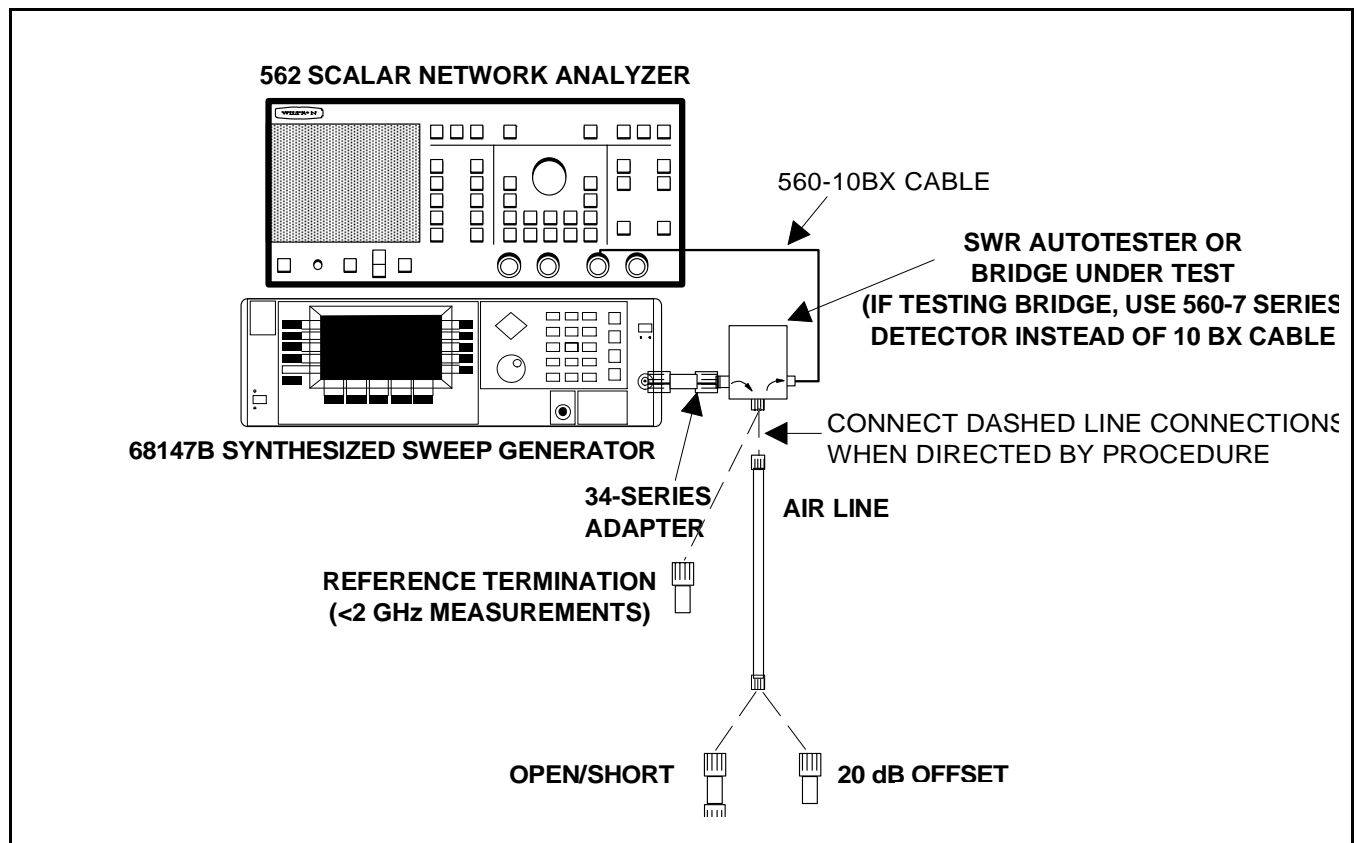

Figure 5. Test Equipment Setup for Directivity Measurement

a. Measuring Directivity At 2 GHz and Above.

1. Connect test setup as shown in Figure 5.
2. Press LINE key on signal source to OPERATE.
3. Press POWER key on network analyzer to ON.
4. Press SYSTEM key on signal source, then select the **Reset** softkey, from the displayed menu.
5. Set signal source for frequency range of device-under-test (DUT) and for maximum possible power, as described below.
 - (a) Press CW/SWEEP SELECT key.
 - (b) Select the **Analog** softkey from the displayed menu.
 - (c) Select the **Edit F1** softkey from the displayed menu.
 - (d) Using the Cursor Control Key or Rotary Data Knob, edit the F1 parameter to equal the low-end frequency of the SWR Autotester or Bridge under test.
 - (e) Select the **Edit F2** softkey and repeat step (d) for the high-end frequency.
 - (f) Select the **Edit L1** softkey, and repeat step (d) to display the source's maximum power level value.
6. Press SYSTEM FUNCTION MENU key on network analyzer.
7. Using MENU up-down keys: Highlight **RESET**, then press SELECT key.
8. Press CHANNEL 2 key to OFF.
9. Press GRATICULE ON/OFF key to ON.
10. Press CHANNEL 1 MENU key.
11. Using MENU up-down keys: Highlight **RETURN LOSS**, then press SELECT key.
12. Press CALIBRATION key.

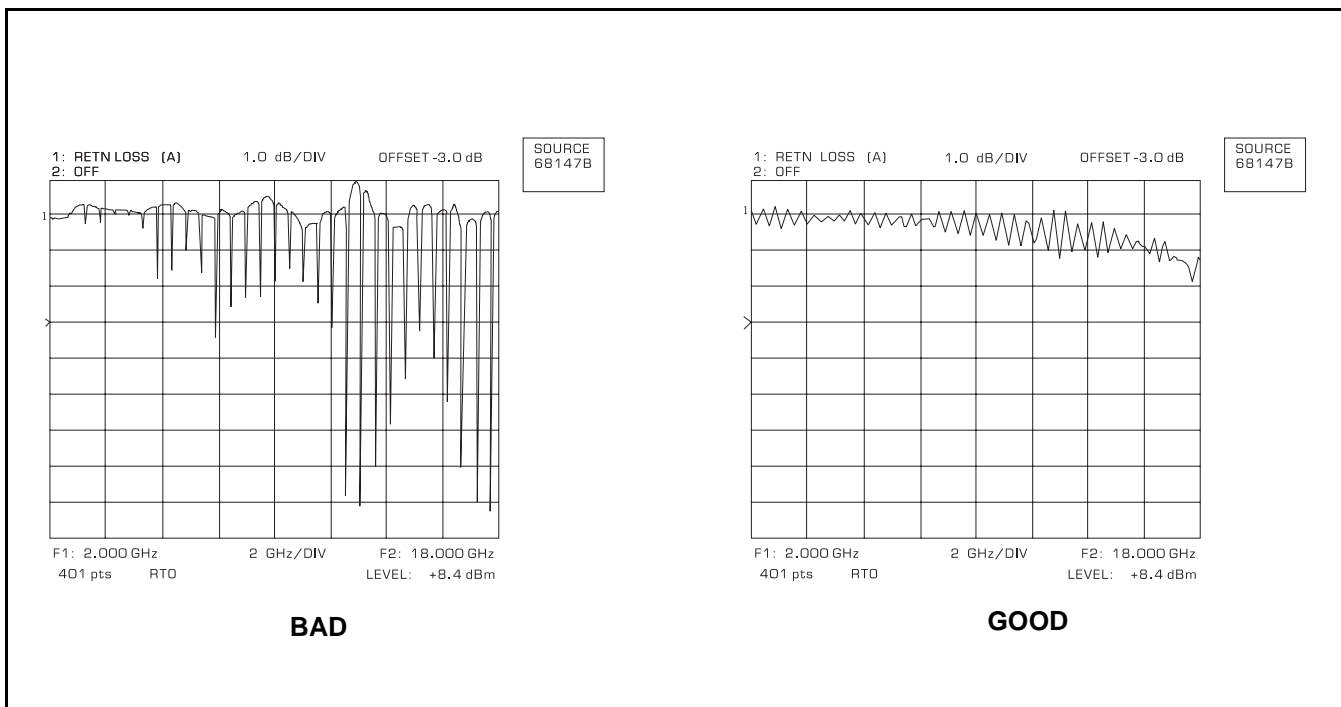

Figure 6. Examples of Good and Bad Air Line Connections

13. Using MENU up-down keys: Highlight **START CAL** then press SELECT key.
14. Connect SWR Autotester to INPUT A, if you have not done so yet.
15. Connect beadless end of air line to test port on SWR Autotester, paying careful attention to making a good connection. The displays shown in Figure 6 indicate good and bad connections.
16. Connect OPEN to air line and press SELECT key.
17. Connect SHORT to air line and press SELECT key.
18. Connect 20 dB Offset to air line and press SELECT key.
19. Press CHANNEL 1 MENU key.
20. Using MENU up-down keys: Highlight REF LINE, then press SELECT key.
21. Using DATA ENTRY knob, set reference line to 4th graticule line from top (Figure 7).

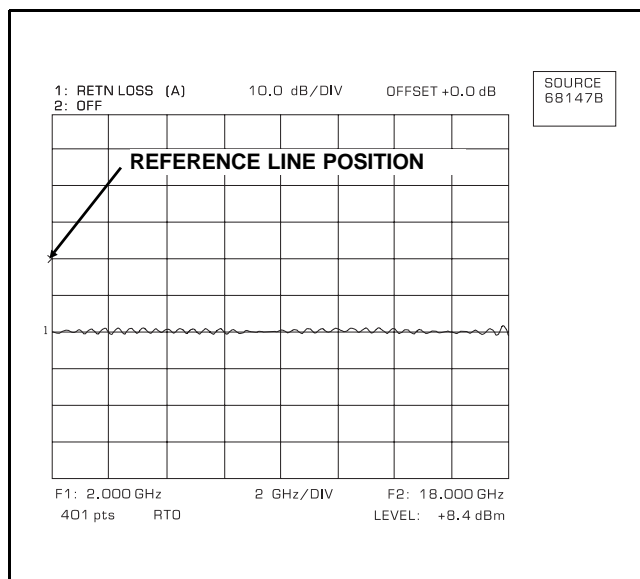

Figure 7. Reference Line Position

22. Press CHANNEL 1 AUTOSCALE key.
23. Press CHANNEL 1 OFFSET/RESOLUTION key.

24. Using MENU up-down keys: Highlight **OFFSET dB**, then press SELECT key.
25. Using DATA ENTRY/CURSOR knob, align the Channel 1 signal with the reference line (Figure 8).

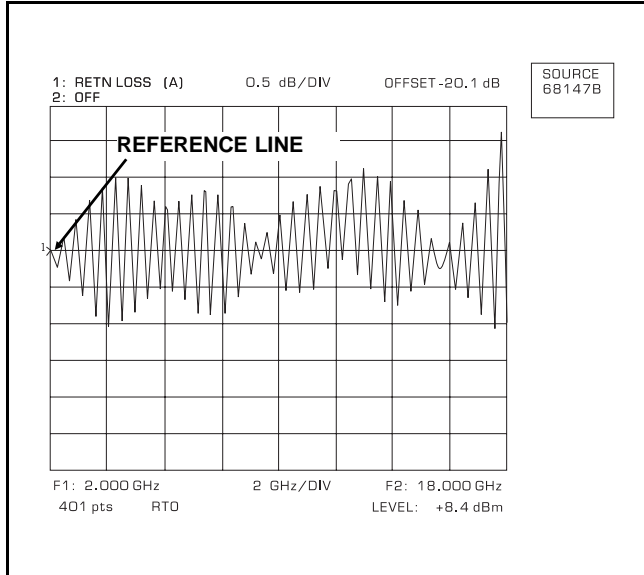

Figure 8. Signal Aligned With the Reference Line

26. Using MENU up-down keys: Highlight **RESOLUTION dB/DIV**, then press SELECT key.
27. Read **OFFSET** value from top of display. This is the value of the 20 dB Offset.
28. Observing the displayed ripple pattern, select the ripple with the greatest amplitude and position its average point (see NOTE) on the reference line.

NOTE

The average point is approximately halfway between the peak and trough values for ripples 3 dB or less. For ripples greater than 3 dB, refer to Table 6.

29. Measure the peak-to-peak value of the selected ripple.

30. In the “REF ±X, Peak to Peak Ripple, dB” column of Table 6, find the value nearest to the peak-to-peak signal value measured in step 29.
31. Read the coordinate value from the “X dB Below Reference” column.
32. Add the dB value from step 30 to the value read in step 31. The sum is the worst-case directivity of the SWR Autotester or bridge. It should equal or exceed the specification in Table 1 or 2.

b. Directivity Measurements Below 2 GHz.

1. Set up equipment as shown in Figure 5.
2. Perform steps 2 thru 13 of subparagraph a.
3. Connect termination to test port of SWR Autotester or bridge being measured*.
4. Press CHANNEL 1 MENU key.
5. Using MENU up-down keys: Highlight REF LINE, then press SELECT key.
6. Using DATA ENTRY knob, set reference line to midscale.
7. Press CHANNEL 1 OFFSET/RESOLUTION key.
8. Using MENU up-down keys: Highlight **OFFSET dB**, then press SELECT key.
9. Using DATA ENTRY knob, set OFFSET dB for the directivity value of the SWR Autotester or bridge being measured.
10. Using MENU up-down keys: Highlight **RESOLUTION dB/DIV**, then press SELECT key.
11. Using DATA ENTRY knob, set RESOLUTION dB/DIV for a convenient value.
12. Observe analyzer display. If measured directivity signal is below the reference line, then the directivity is within the specified value.

* The return loss of the termination must be higher than the directivity of the SWR Autotester or bridge being measured. The ANRITSU terminations recommended in Table 4 meet this requirement.

c. Pin Depth Measurements.

Gauging sets for measuring terminations are available from ANRITSU. Table 5 provides a listing that correlates each SWR Autotester and bridge type with its appropriate gauging set. Instructions for gauging air line connectors are provided with gauging set.

8. MAINTENANCE

ANRITSU recommends that no maintenance other than cleaning be attempted by customer. The SWR Autotester or bridge should be returned to ANRITSU for repair and/or service when needed.

Clean connector interfaces with clean cotton swab dampened with alcohol.

CAUTION

Excessive pressure when cleaning can damage the center conductor support bead in the SWR Autotester or Bridge. Ensure that the cotton swab is small enough to fit into the connector without applying pressure to the center conductor. When cleaning, limit the pressure so as to lightly contact the connector. To obtain cotton swabs that are smaller than the standard type available in most retail outlets, try contacting a medical-lab-type supply center.

Table 5. Available Gauging Sets

Model	Connector Type	Gauging Set Model
60A50, 58A50, 87A50, 87A50-1 63A50, 59A50, 97A50, 97A50-1	GPC-7	01-161
60N50, 62N75, 63N50, 97N50, 97N50-1	N Male	01-163
60NF50, 62NF75, 63NF50, 97NF50, 97NF50-1	N Female	
97S50, 97S50-1	WSMA Male	01-162
97SF50, 97SF50-1	WSMA Female	

CAUTION

If installed, do not disturb the teflon washer on the center conductor (refer to paragraph 5c).

Table 6. Microwave Measurement

Conversion tables for Return Loss, Reflection Coefficient, and SWR with tabular values for interaction of a small phasor X with a large phasor (unity reference) expressed in dB related to reference.

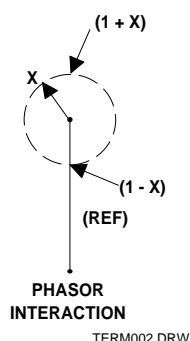

SWR	Reflection Coefficient	Return Loss (dB)	Relative to Unity Reference			
			X dB Below Reference	REF + X dB	REF - X dB	REF ± X Peak to Peak Ripple dB
17.3910	0.8913	1	1	5.5350	-19.2715	24.8065
8.7242	0.7943	2	2	5.0780	-13.7365	18.8145
5.8480	0.7079	3	3	4.6495	-10.6907	15.3402
4.4194	0.6310	4	4	4.2489	-8.6585	12.9073
3.5698	0.5623	5	5	3.8755	-7.1773	11.0528
3.0095	0.5012	6	6	3.5287	-6.0412	9.5699
2.6146	0.4467	7	7	3.2075	-5.1405	8.3480
2.3229	0.3981	8	8	2.9108	-4.4096	7.3204
2.0999	0.3548	9	9	2.6376	-3.8063	6.4439
1.9250	0.3162	10	10	2.3866	-3.3018	5.6884
1.7849	0.2818	11	11	2.1567	-2.8756	5.0322
1.6709	0.2512	12	12	1.9465	-2.5126	4.4590
1.5769	0.2239	13	13	1.7547	-2.2013	3.9561
1.4985	0.1995	14	14	1.5802	-1.9331	3.5133
1.4326	0.1778	15	15	1.4216	-1.7007	3.1224
1.3767	0.1585	16	16	1.2778	-1.4988	2.7766
1.3290	0.1413	17	17	1.1476	-1.3227	2.4703
1.2880	0.1259	18	18	1.0299	-1.1687	2.1986
1.2528	0.1122	19	19	0.9237	-1.0337	1.9574
1.2222	0.1000	20	20	0.8279	-0.9151	1.7430
1.1957	0.0891	21	21	0.7416	-0.8108	1.5524
1.1726	0.0794	22	22	0.6639	-0.7189	1.3828
1.1524	0.0708	23	23	0.5941	-0.6378	1.2319
1.1347	0.0631	24	24	0.5314	-0.5661	1.0975
1.1192	0.0562	25	25	0.4752	-0.5027	0.9779
1.1055	0.0501	26	26	0.4248	-0.4466	0.8714
1.0935	0.0447	27	27	0.3796	-0.3969	0.7765
1.0829	0.0398	28	28	0.3391	-0.3529	0.6919
1.0736	0.0355	29	29	0.3028	-0.3138	0.6166
1.0653	0.0316	30	30	0.2704	-0.2791	0.5495
1.0580	0.0282	31	31	0.2414	-0.2483	0.4897
1.0515	0.0251	32	32	0.2155	-0.2210	0.4365
1.0458	0.0224	33	33	0.1923	-0.1967	0.3890
1.0407	0.0200	34	34	0.1716	-0.1751	0.3467
1.0362	0.0178	35	35	0.1531	-0.1558	0.3090
1.0322	0.0158	36	36	0.1366	-0.1388	0.2753
1.0287	0.0141	37	37	0.1218	-0.1236	0.2454
1.0255	0.0126	38	38	0.1087	-0.1100	0.2187
1.0227	0.0112	39	39	0.0969	-0.0980	0.1949
1.0202	0.0100	40	40	0.0864	-0.0873	0.1737
1.0180	0.0089	41	41	0.0771	-0.0778	0.1548
1.0160	0.0079	42	42	0.0687	-0.0693	0.1380
1.0143	0.0071	43	43	0.0613	-0.0617	0.1230
1.0127	0.0063	44	44	0.0546	-0.0550	0.1096
1.0113	0.0056	45	45	0.0487	-0.0490	0.0977
1.0101	0.0050	46	46	0.0434	-0.0436	0.0871
1.0090	0.0045	47	47	0.0387	-0.0389	0.0776
1.0080	0.0040	48	48	0.0345	-0.0346	0.0692
1.0071	0.0035	49	49	0.0308	-0.0309	0.0616
1.0063	0.0032	50	50	0.0274	-0.0275	0.0549
1.0057	0.0028	51	51	0.0244	-0.0245	0.0490
1.0050	0.0025	52	52	0.0218	-0.0218	0.0436
1.0045	0.0022	53	53	0.0194	-0.0195	0.0389
1.0040	0.0020	54	54	0.0173	-0.0173	0.0347
1.0036	0.0018	55	55	0.0154	-0.0155	0.0309
1.0032	0.0016	56	56	0.0138	-0.0138	0.0275
1.0028	0.0014	57	57	0.0123	-0.0123	0.0245
1.0025	0.0013	58	58	0.0109	-0.0109	0.0219
1.0022	0.0011	59	59	0.0097	-0.0098	0.0195
1.0020	0.0010	60	60	0.0087	-0.0087	0.0174

Step 1. Separate a single WSMA connector compensation washer and trim away the interconnecting tabs.



Step 2. Connect the 560-98SF50 SWR Autotester input port to the signal source RF output port, and loosely tighten connector. Orient the WSMA female connector (test port) up.



Step 3. Insert the compensation washer into the opening of the WSMA female connector, as shown.

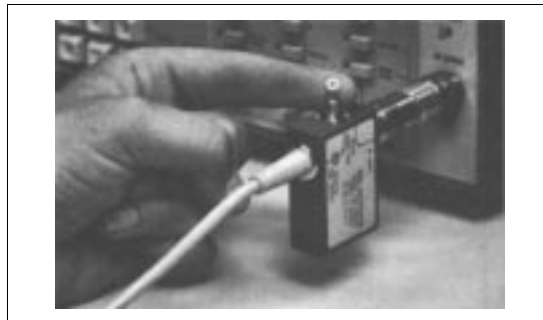

Step 4. Connect beaded end of the air line per application. Tilt the air line horizontally. At unbeaded end, center the inner conductor with the center of the connector opening.



Figure 9. Example for Using Compensation Washer with WSMA Connectors (1 of 2)

Step 5. Loosen the SWR Autotester input port connector and rotate unit horizontally, as shown at left. Align un-beaded end of Air Line with test port connector and carefully mate connectors. Tighten all connectors carefully.



NOTE

For a 560-98S50 SWR Autotester (male WSMA test port) in combination with a 19SF50 Air Line, insert the compensation washer into the female WSMA connector of the air line (beaded end).

Figure 9. Example for Using Compensation Washer with WSMA Connectors (2 of 2)

WARRANTY

The ANRITSU product(s) listed on the title page is (are) warranted against defects in materials and workmanship for one year from the date of shipment.

ANRITSU's obligation covers repairing or replacing products which prove to be defective during the warranty period. Buyers shall prepay transportation charges for equipment returned to ANRITSU for warranty repairs. Obligation is limited to the original purchaser. ANRITSU is not liable for consequential damages.

LIMITATION OF WARRANTY

The foregoing warranty does not apply to ANRITSU connectors that have failed due to normal wear. Also, the warranty does not apply to defects resulting from improper or inadequate maintenance by the Buyer, unauthorized modification or misuse, or operation outside of the environmental specifications of the product. No other warranty is expressed or implied, and the remedies provided herein are the Buyer's sole and exclusive remedies.

TRADEMARK ACKNOWLEDGEMENTS

V Connector and K Connector are registered trademarks of ANRITSU Company. GPC-7 is a registered trademark of Amphenol Corporation.

NOTICE

ANRITSU Company has prepared this manual for use by ANRITSU Company personnel and customers as a guide for the proper installation, operation and maintenance of ANRITSU Company equipment and computer programs. The drawings, specifications, and information contained herein are the property of ANRITSU Company, and any unauthorized use or disclosure of these drawings, specifications, and information is prohibited; they shall not be reproduced, copied, or used in whole or in part as the basis for manufacture or sale of the equipment or software programs without the prior written consent of ANRITSU Company.