

**Agilent E5260 Series
High Speed Measurement
Solutions
Agilent E5270 Series
Precision Measurement
Solutions**

User's Guide



Agilent Technologies

Notices

© Agilent Technologies, Inc. 2004, 2005, 2007, 2009

No part of this manual may be reproduced in any form or by any means (including electronic storage and retrieval or translation into a foreign language) without prior agreement and written consent from Agilent Technologies, Inc. as governed by United States and international copyright laws.

Manual Part Number

E5260-90000

Edition

Edition 1, October 2004
Edition 2, July 2005
Edition 3, July 2007
Edition 4, September 2009

Agilent Technologies, Inc.
5301 Stevens Creek Blvd
Santa Clara, CA 95051 USA

Warranty

The material contained in this document is provided “as is,” and is subject to being changed, without notice, in future editions. Further, to the maximum extent permitted by applicable law, Agilent disclaims all warranties, either express or implied, with regard to this manual and any information contained herein, including but not limited to the implied warranties of merchantability and fitness for a particular purpose. Agilent shall not be liable for errors or for incidental or consequential damages in connection with the furnishing, use, or performance of this document or of any information contained herein. Should Agilent and the user have a separate written agreement with warranty terms covering the material in this document that conflict with these terms, the warranty terms in the separate agreement shall control.

Technology Licenses

The hardware and/or software described in this document are furnished under a license and may be used or copied only in accordance with the terms of such license.

Restricted Rights Legend

If software is for use in the performance of a U.S. Government prime contract or subcontract, Software is delivered and licensed as “Commercial computer software” as defined in DFAR 252.227-7014 (June 1995), or as a “commercial item” as defined in FAR 2.101(a) or as “Restricted computer software” as defined in FAR 52.227-19 (June 1987) or any equivalent agency regulation or contract clause. Use, duplication or disclosure of Software is subject to Agilent Technologies’ standard commercial license terms, and non-DOD Departments and Agencies of the U.S. Government will receive no greater than Restricted Rights as

defined in FAR 52.227-19(c)(1-2) (June 1987). U.S. Government users will receive no greater than Limited Rights as defined in FAR 52.227-14 (June 1987) or DFAR 252.227-7015 (b)(2) (November 1995), as applicable in any technical data.



Agilent Technologies

DECLARATION OF CONFORMITY
According to ISO/IEC Guide 22 and CEN/CENELEC EN 45014



Manufacturer's Name: Agilent Technologies International sarl
Manufacturer's Address: Rue de la Gare 29
Supplier's Address: CH - 1110 Morges
Switzerland

Declares under sole responsibility that the product as originally delivered

Product Name: 8 Slot High Speed Measurement Mainframe
High Speed High Power SMU Module(Plug-in Module)
High Speed Medium Power SMU Module(Plug-in Module)
2 Channel (Medium Power, Medium Power)Source/Monitor Unit
2 Channel (High Power, Medium Power)Source/Monitor Unit
Model Number: Agilent E5260A
Agilent E5290A
Agilent E5291A
Agilent E5262A
Agilent E5263A
Product Options: This declaration covers all options of the above product(s)

complies with the essential requirements of the following applicable European Directives, and carries the CE marking accordingly:

Low Voltage Directive (2006/95/EC)
EMC Directive (2004/108/EC)

and conforms with the following product standards

EMC	Standard	Limit
	IEC 61326-1:2005 / EN 61326-1:2006	
	CISPR 11:2003 / EN55011:1998+A1:1999+A2 :2002	Group 1 Class A
	IEC 61000-4-2:2001 / EN 61000-4-2:1995+A1:1998+A2:2001	4 kV CD, 8 kV AD
	IEC 61000-4-3:2002+A1:2002/EN 61000-4-3:2002+A1:2002	3 V/m / 80 MHz-1 GHz / 1.4-2 GHz, 1 V/m / 2-2.7 GHz
	IEC 61000-4-4:2004 / EN 61000-4-4:2004	0.5 kV signal lines, 1 kV power lines
	IEC 61000-4-5:2001/EN 61000-4-5:1995+A1:2001	0.5 kV line-line, 1 kV line-ground
	IEC 61000-4-6:2003 / EN 61000-4-6:1996+A1:2001	3 V, 0.15-80 MHz
	IEC 61000-4-11:2004 / EN 61000-4-11:2004	0 % for 1/0.5 cycle, 0 % for 250/300 cycles, 70 % for 25/30 cycles

Canada: ICES-001:2004

Australia/New Zealand: AS/NZS CISPR 11:2004

The product was tested in a typical configuration with Agilent Technologies test systems.

Safety IEC 61010-1:2001 / EN 61010-1:2001
Canada: CAN/CSA-C22.2 No. 1010.1-92, NRTL/C

Supplementary Information:

This DoC applies to above-listed products placed on the EU market after:

July 15, 2009

Date

川路 利行

Toshiyuki Kawaji

QA Manager
Agilent Technologies



Agilent Technologies

DECLARATION OF CONFORMITY
According to ISO/IEC Guide 22 and CEN/CENELEC EN 45014



Manufacturer's Name: Agilent Technologies International sarl
Manufacturer's Address: Rue de la Gare 29
Supplier's Address: CH - 1110 Morges
Switzerland

Declares under sole responsibility that the product as originally delivered

Product Name: 8 Slot Precision Measurement Mainframe
High Power Source/Monitor Unit Module
Medium Power Source/Monitor Unit Module
Atto Level High Resolution Source/Monitor Unit Module
Atto Sense and Switch Unit
Model Number: Agilent E5270B
Agilent E5280B
Agilent E5281B
Agilent E5287A
Agilent E5288A
Product Options: This declaration covers all options of the above product(s)

complies with the essential requirements of the following applicable European Directives, and carries the CE marking accordingly:

Low Voltage Directive (2006/95/EC)
EMC Directive (2004/108/EC)

and conforms with the following product standards

EMC	Standard	Limit
	IEC 61326-1:2005 / EN 61326-1:2006	
	CISPR 11:2003 / EN55011:1998+A1:1999+A2 :2002	Group 1 Class A
	IEC 61000-4-2:2001 / EN 61000-4-2:1995+A1:1998+A2:2001	4 kV CD, 8 kV AD
	IEC 61000-4-3:2002+A1:2002/EN 61000-4-3:2002+A1:2002	3 V/m / 80 MHz-1 GHz / 1.4-2 GHz, 1 V/m / 2-2.7 GHz
	IEC 61000-4-4:2004 / EN 61000-4-4:2004	0.5 kV signal lines, 1 kV power lines
	IEC 61000-4-5:2001/EN 61000-4-5:1995+A1:2001	0.5 kV line-line, 1 kV line-ground
	IEC 61000-4-6:2003 / EN 61000-4-6:1996+A1:2001	3 V, 0.15-80 MHz
	IEC 61000-4-11:2004 / EN 61000-4-11:2004	0 % for 1/0.5 cycle, 0 % for 250/300 cycles, 70 % for 25/30 cycles
	Canada: ICES-001:2004	
	Australia/New Zealand: AS/NZS CISPR 11:2004	
	The product was tested in a typical configuration with Agilent Technologies test systems.	

Safety IEC 61010-1:2001 / EN 61010-1:2001
Canada: CAN/CSA-C22.2 No. 1010.1-92, NRTL/C

Supplementary Information:
This DoC applies to above-listed products placed on the EU market after:

July 15, 2009
Date

川路 利行

Toshiyuki Kawaji
QA Manager
Agilent Technologies

- **Herstellerbescheinigung**

GEÄUSCHEMISSION

L_{pa} < 70 dB

am Arbeitsplatz

normaler Betrieb

nach DIN 45635 T. 19

- **Manufacturer's Declaration**

ACOUSTIC NOISE EMISSION

L_{pa} < 70dB

operator position

normal operation

per ISO 7779

NOTE

This ISM device complies with Canadian ICES-001.

Cet appareil ISM est conforme à la norme NMB-001 du Canada.



This product complies with the WEEE Directive (2002/96/EC) marking requirements. The affixed label indicates that you must not discard this electrical/electronic product in domestic household waste.

Product Category: With reference to the equipment types in the WEEE Directive Annex I, this product is classed as a “Monitoring and Control instrumentation” product.

Do not dispose in domestic household waste.

To return unwanted products, contact your local Agilent office, or see www.agilent.com/environment/product/ for more information.

Safety Summary

The following general safety precautions must be observed during all phases of operation, service, and repair of this instrument. Failure to comply with these precautions or with specific warnings elsewhere in this manual may impair the protections provided by the equipment. In addition, it violates safety standards of design, manufacture, and intended use of the instrument. Agilent Technologies, Inc. assumes no liability for customer's failure to comply with these requirements.

NOTE

Agilent E5260/E5270 complies with INSTALLATION CATEGORY II for mains input and INSTALLATION CATEGORY I for measurement input terminals, and POLLUTION DEGREE 2 defined in IEC 61010-1.

Agilent E5260/E5270 is an INDOOR USE product.

- *GROUND THE INSTRUMENT*

This is Safety Class I instrument. To minimize shock hazard, the instrument chassis and cabinet must be connected to an electrical ground. The power terminal and the power cable must meet International Electrotechnical Commission (IEC) safety standards.

- *DO NOT OPERATE IN AN EXPLOSIVE ATMOSPHERE*

Do not operate the instrument in the presence of flammable gases or fumes. Operation of any electrical instrument in such an environment constitutes a definite safety hazard.

- *KEEP AWAY FROM LIVE CIRCUITS*

Operation personnel must not remove instrument covers. Component replacement and internal adjustments must be made by qualified maintenance personnel. Do not replace components with power cable connected. Under certain conditions, dangerous voltages may exist even with the power cable removed. To avoid injuries, always disconnect power and discharge circuits before touching them.

- *DO NOT SERVICE OR ADJUST ALONE*

Do not attempt internal service or adjustment unless another person, capable of rendering first aid and resuscitation, is present.

- *DO NOT SUBSTITUTE PARTS OR MODIFY INSTRUMENT*

Because of the danger of introducing additional hazards, do not install substitute parts or perform any unauthorized modification to the instrument. Return the instrument to a Agilent Technologies Sales and Service Office for services and repair to ensure that safety features are maintained.

- *DANGEROUS PROCEDURE WARNINGS*

Warnings, such as example below, precede potentially dangerous procedures throughout this manual. Instructions contained in the warnings must be followed.

WARNING

Dangerous Voltage, capable of causing death, are present in this instrument. Use extreme caution when handling, testing, and adjusting.

Safety Symbols

The general definitions of safety symbols used on equipment or in manuals are listed below.



Instruction manual symbol: the product will be marked with this symbol when it is necessary for the user to refer to the instruction manual in order to protect against damage to the instrument.



Indicates dangerous voltage and potential for electrical shock. Do not touch terminals that have this symbol when instrument is on.



Protective conductor terminal. For protection against electrical shock in case of a fault. Used with field wiring terminals to indicate the terminal which must be connected to ground before operating equipment.



Frame or chassis terminal. A connection to the frame (chassis) of the equipment which normally includes all exposed metal structures.



Indicates earth (ground) terminal.



Alternating current.



Direct current.



ON (Supply).



OFF (Supply).



STANDBY (Supply).

CAT 1 Means INSTALLATION CATEGORY I. Measurement terminals on the rear panel comply with INSTALLATION CATEGORY I.

WARNING

The warning sign denotes a hazard. It calls attention to a procedure, practice, condition or the like, which, if not correctly performed or adhered to, could result in injury or death to personal.

CAUTION

The caution sign denotes a hazard. It calls attention to an operating procedure, practice, condition or the like, which, if not correctly performed or adhered to, could result in damage to or destruction of part or all of the product.

HIGH VOLTAGE SHOCK HAZARD

The Agilent E5260/E5270 can force dangerous voltages (200 V for HPSMU, and 100 V for MPSMU) at the force, guard, and sense terminals. To prevent electric shock hazard, the following safety precautions must be observed during the use of the Agilent E5260/E5270.

- Use a three-conductor AC power cable to connect cabinet (if used) and Agilent E5260/E5270 to an electric ground (safety ground).
- If you do not use Agilent 16442 Test Fixture, make sure to connect the INTLK terminal to a switch that turns off when the shielding box access door is opened.
- Confirm periodically that INTLK function works normally.
- Before touching the connections of the force, guard, and sense terminals, turn the Agilent E5260/E5270 off and discharge any capacitors whenever possible. If you do not turn the Agilent E5260/E5270 off, complete “all” of the following items, regardless of any Agilent E5260/E5270 settings.
 - Terminate measurement by pressing Output key, confirm that the Output status indicator is not lit.
 - Confirm that the HIGH VOLTAGE indicator is not lit.
 - Open the shielding box access door (open the INTLK terminal).
 - Discharge any capacitors if the capacitance is connected to an SMU.
- Warn workers in the vicinity of the Agilent E5260/E5270 about dangerous conditions.

高電圧感電注意

Agilent E5260/E5270 のフォース、ガード、センス端子には、危険電圧が出力されることがあります（HPSMU の場合は最大± 200 Vdc、MPSMU の場合は最大± 100 Vdc）。感電事故防止のため、必ず以下の事柄を守ってください。

- 3 極電源ケーブルを使用して Agilent E5260/E5270 を接地すること。
- Agilent 16442 テスト・フィクスチャ以外のフィクスチャ、あるいはプローバを使用する場合には、シールド・ボックスにインターロック回路を接続すること。インターロック回路とは、シールド・ボックスの蓋を開けた時に Agilent E5260/E5270 の INTLK 端子を開放にすることができる回路のことをいいます。
- インターロック機能が正常であることを定期的に確認すること。
- フォース、ガード、センス端子に繋がる接続部に触れる前には、測定器の電源を切ること。また、測定系にキャパシタが接続されている場合は、キャパシタを放電すること。電源を切らない場合は、以下の事項を全て実施すること。
 - Output キーを押して Output インジケータが消灯したことを確認すること。
 - 高電圧警告（HIGH VOLTAGE）インジケータが消灯していることを確認すること。
 - シールド・ボックスの蓋を開ける（INTLK 端子を開放する）こと。
 - キャパシタが SMU に接続されているならば、キャパシタを放電すること。
- 周囲のほかの作業者に対しても、高電圧危険に対する注意を徹底すること。

PRECAUTIONS POUR COMMOTION A HAUTE TENSION

Une tension dangereuse (max. \pm pour HPSMU; 200 Vdc, max. \pm pour MPSMU; 100 Vdc) émanant du dispositif Agilent E5260/E5270 peut être sortie aux bornes de force, d'appareil de protection ou de détection. Les précautions suivantes doivent être obserées contre commotion électrique accidentelle:

- Mettre à la terre le dispositif Agilent E5260/E5270 au moyen du câble d'alimentation tripolair.
- En cas de hors service du dispositif d'essai, FIXTURE Agilent 16442, connecter les bornes de verrouillage (INTLK) de façon à ce que soit ouverte lorsque le couvercle de la boîte de blindage est ouvert.
- Essayer périodiquement le fonctionnement normal de verrouillage.
- Avant de toucher la partie connexion à partir des bornes de force, d'appareil de protection et de détection, mettre hors tension le dispositif Agilent E5260/E5270. Et, en cas de condensateurs connectés au circuit de mesure, décharger ces condensateurs. Lorsque l'alimentation n'est pas mise hors tension, les 4 instructions suivantes doivent être exécutées:
 - Finir la mesure en appuyant sur la touche "Output"; vérifier que l'indicateur "Output" n'est pas allumé.
 - S'assurer que soit allumé l'indicateur d'alarme de la haute tension.
 - Ouvrir le couvercle de la boîte de blindage (Ouvrir les bornes de verrouillage).
 - En cas de condensateurs connectés à SMU, décharger les condensateurs.
- Alerter d'autres personnes autour de vous contre le danger de haute tension.

Achtung! Gefährliche Spannung

Von den Geräten Agilent E5260/E5270 können Spannungen an den Anschlüssen "Force, Guard und Sense" von bis zu 200 V ausgehen. Um elektrischem Schlag vorzubeugen, ist bei der Benützung der Geräte Agilent E5260/E5270 folgendes zu beachten:

- Erden Sie das Kabinett (falls verwendet) sowie die Geräte Agilent E5260/E5270 mittels dreiadrigter Netzleitungen.
- Wenn die Meßfassung, Agilent 16442, zwar angeschlossen, jedoch nicht verwendet wird, schließen Sie die Verriegelungsklemme (INTLK) so an, daß bei geöffnetem Deckel die Stromzuführung zu Agilent 16442 auf jeden Fall unterbrochen wird.
- Vergewissern Sie sich regelmäßig daß die Verriegelungsfunktion korrekt arbeitet.
- Schalten Sie die Geräte Agilent E5260/E5270 aus, und entladen Sie alle Kapazitäten bevor Sie die Anschlüsse "Force, Guard und Sense" berühren. Falls Sie die Geräte Agilent E5260/E5270 nicht ausschalten, führen Sie unabhängig von den Geräteeinstellungen folgende Schritt durch:
 - Beenden Sie die gegenwärtige Messung durch Drücken der Output Taste (die Output Leuchtdiode erlischt).
 - Vergewissern Sie sich daß die Hochspannungswarnlampe erloschen ist.
 - Öffnen Sie den Deckel der Meßfassung Agilent 16442 (die Verriegelungsklemme (INTLK) öffnen).
 - Entladen Sie alle an SMUs angeschlossenen Kondensatoren (falls vorhanden).
- Informieren Sie Personen in unmittelbarer Nähe der Geräte Agilent E5260/E5270 über die Gefährlichkeit der bestehenden Hochspannung, und sichern Sie den Zugang zum Prüfplatz zum Schutz Dritter.

In This Manual

This manual describes the front panel operation, installation, and functions of the Agilent Technologies E5270B/E5260A/E5262A/E5263A (Agilent E5260/E5270 series). This manual consists of the following chapters:

- Chapter 1, “Getting Started”

This chapter briefly explains how to use the Agilent E5260/E5270 by the front panel operation.
- Chapter 2, “Introduction”

This chapter describes overview, specifications, accessories and options of the Agilent E5260/E5270.
- Chapter 3, “Installation”

This chapter explains how to install the Agilent E5260/E5270, and how to connect the device under test to a test fixture.
- Chapter 4, “Front Panel Reference”

This chapter provides the reference information of the Agilent E5260/E5270 front panel keys.
- Chapter 5, “Front Panel Operations”

This chapter explains how to use the Agilent E5260/E5270 in the local condition.
- Chapter 6, “Function Details”

This chapter explains the several functions and initial settings of the Agilent E5260/E5270.
- Chapter 7, “If You Have a Problem”

This chapter explains how to solve a problem if you encounter any problem, and describes error codes.

Contents

1. Getting Started

2. Introduction

Agilent E5260/E5270 Series	2-3
Front View	2-4
	2-5
Rear View	2-7
Measurement Units	2-8
Compliance	2-8
GNDU - Ground Unit	2-9
E5280B Precision HPSMU	2-10
E5281B Precision MPSMU	2-13
E5287A Atto Level HRSMU	2-16
E5290A High Speed HPSMU	2-20
E5291A High Speed MPSMU	2-23
Specifications	2-26
Introduction	2-26
Hardware	2-28
Functions	2-45
General Specifications	2-49
Accessories and Options	2-50

3. Installation

	3-2
Requirements	3-3
Power Requirements	3-3
Operating Environment	3-3
Storing/Shipping Environment	3-3

Contents

Ventilation Requirements	3-4
Power Cable	3-4
Inspection and Installation	3-6
To Inspect the Agilent E5260/E5270 and Accessories	3-6
To Check the Agilent E5260/E5270 Operation	3-7
To Execute Diagnostics and Self-calibration	3-7
To Remove or Install Plug-in Module	3-8
Installing Accessories	3-10
To Connect 16442B Test Fixture	3-11
To Connect Connector Plate	3-13
⚠	3-15
To Connect ASU	3-16
To Connect GNDU Adapter	3-20
Mounting Connectors	3-21
⚠ To Make an Interlock Circuit	3-23
To Connect the GNDU Output	3-26
To Connect the SMU Output	3-27
Connecting Measurement Devices	3-29
Using Test Fixture	3-30
Using Connector Plate	3-32
Maintenance	3-36
Calibration	3-36
Cleaning	3-36
Self-test and Diagnostics	3-37
4. Front Panel Reference	
Display and Front Panel Keys	4-3
Display Images	4-3
Front Panel Key Locations	4-5

Contents

Channel Status Area	4-6
Setup Data Area	4-7
Measurement Data Area	4-8
Status Data Area	4-9
Front Panel Key Details	4-10
Measure key group	4-11
Output key group	4-14
Edit key group	4-17
Setup Menus	4-18
Setup Menu	4-18
Calibration and Test Menu	4-25
Measurement Range Setup Menu	4-31
Output Range Setup Menu	4-32

5. Front Panel Operations

Available Functions	5-3
Setting Up Agilent E5260/E5270	5-4
To Set Line Frequency	5-5
To Initialize Agilent E5260/E5270	5-5
To Set Beeper	5-5
To Apply Default Value	5-5
To Select Monitor Items	5-6
To Perform Self-test	5-7
To Perform Self-Calibration	5-8
To Perform Diagnostics	5-9
To Set Auto-Calibration	5-11
To Set ADC Zero Function	5-11
To Read Error Message	5-12
To Display Firmware Revision	5-12
To Display Module Information	5-13

Contents

To Display Module Serial Number	5-13
To Set GPIB Address	5-14
To Set Remote Display Mode	5-14
To Return to Local Mode	5-14
Applying Source Output	5-15
To Apply DC Current/Voltage	5-16
To Set Output/Compliance Value	5-17
To Set Source Output to Zero	5-18
To Set Output Range	5-18
To Use Series Resistor	5-19
To Use Filter	5-19
To Switch ASU Internal Connection	5-20
Making Measurement	5-21
To Measure DC Current/Voltage	5-22
To Abort Measurement	5-23
To Select Measurement Item	5-23
To Select Measurement Range	5-24
To Set A/D Converter	5-25
To Set Wait Time	5-27
To Set Data Display Format	5-28

6. Function Details

Measurement Mode	6-3
Measurement Mode in Local Condition	6-3
Measurement Mode in Remote Condition	6-4
Ranging Mode	6-5
To Set the Ranging Mode	6-5
Auto Ranging	6-6
Limited Auto Ranging	6-7
Fixed Range	6-7

Contents

Compliance Range	6-7
Enhanced Auto Ranging for Current Measurement	6-8
Compliance	6-9
Polarity and Output Area	6-9
Power Compliance	6-11
To Set Compliance	6-13
SMU Pulse	6-15
To Set Pulse Output	6-15
Measurement Time	6-16
Integration Time	6-16
Overhead Time	6-18
To Specify Source Output Time	6-18
Wait Time	6-19
Atto Sense and Switch Unit	6-20
Filter	6-22
Series Resistor	6-23
Interlock Function	6-24
Auto Power Off Function	6-25
Initial Settings	6-26

7. If You Have a Problem

When You Install the E5260/E5270	7-3
If the E5260/E5270 cannot be Powered on	7-3
To Simplify the Connections	7-3
When You Make a Measurement	7-4
If Leaving Connections Damages Devices after Measurement	7-4
If Measured Value Oscillates when Measuring High-Frequency Devices	7-5
If Measured Value Oscillates when Measuring Negative Resistance	7-6

Contents

If Noise Affects the Measured Values	7-7
If Measured Voltage has some Error when Forcing a Large Current.	7-8
If Large Current Causes High Temperature (Thermal Drift)	7-8
If Measurement Takes More Time than Specified	7-8
If Measurement Damages the Device under Test	7-9
Channel Status Code	7-10
Error Codes	7-11
Operation Error	7-11
Self-test/Calibration Error	7-20

1 **Getting Started**

Getting Started

This chapter describes the basic operations of the Agilent E5260/E5270. Before learning details of the Agilent E5260/E5270, let's try to use the Agilent E5260/E5270 briefly. The operations need the Agilent E5260/E5270 and power cable only. During the operations, open the measurement terminals.

Basic Operations:

1. "Turning on the Agilent E5260/E5270"
2. "Setting up SMU1, forcing DC voltage, and measuring DC current"
3. "Setting up SMU2, forcing DC voltage, and measuring DC current"
4. "Stopping measurement"
5. "Executing a spot measurement, and starting repeat measurement"
6. "Changing source output value during repeat measurement"
7. "Changing measurement item during repeat measurement"
8. "Stopping source output and measurement"

Agilent E5260/E5270 Front Panel:

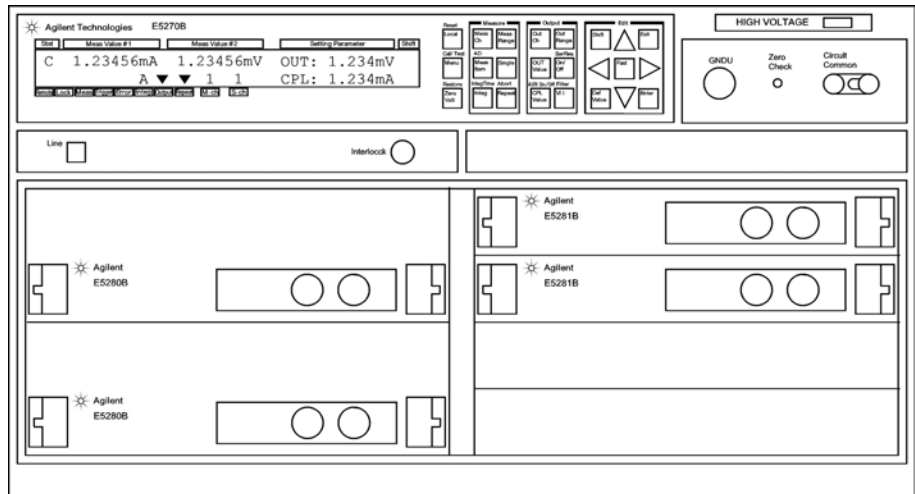

NOTE

Front Panel Keys

The Agilent E5260/E5270 has 24 front panel keys. The front panel keys are located as shown below. Front panel operation is available when the Agilent E5260/E5270 is in the local condition.

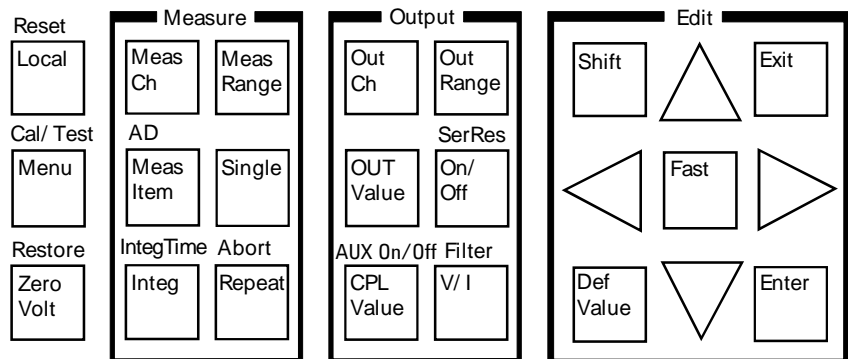

The Agilent E5260A/E5262A/E5263A do not have the “AD” and “AUX On/Off” shift keys.

Getting Started

Step 1. Turning on the Agilent E5260/E5270

Connect the power cable from the Agilent E5260/E5270 to an AC power outlet, and press the **Line** switch.

After the self-calibration, the LCD shows the following display:

Stat	Meas Value #1	Meas Value #2	Setting Parameter	Shift					
	OFF		OUT: 0.00 V						
	A	1 1	CPL: 100.0uA						
Errate	Lock	Meas	Trigger	Error	Integ	Output	Repeat	M-ch	S-ch

Step 2. Setting up SMU1, forcing DC voltage, and measuring DC current

1. Press the **CPL Value** key. A cursor appears on the lowest digit of the integral part of the CPL value. The CPL shows the compliance value.
2. Press the Right arrow key to move the cursor on the arithmetic point.
3. Press the Up arrow key to set the CPL value to 100 mA, and press the **Enter** key to fix the value. Then press the **Enter** key again. The cursor disappears.
4. Press the **On/Off** key. The SMU1 starts voltage output.
5. Press the **Repeat** key. The SMU1 starts current measurement.

In the following example, the measured data is just an example. During the repeat measurement, you may not be able to read the measured data.

Stat	Meas Value #1	Meas Value #2	Setting Parameter	Shift					
	0.00020nA		OUT: 0.00 V						
	A ▼ ▼	1 1	CPL: 100.0mA						
Errate	Lock	Meas	Trigger	Error	Integ	Output	Repeat	M-ch	S-ch

NOTE

The Output indicator shows that DC voltage or current is applied by the channel specified by the S-ch indicator.

The Repeat indicator shows that the repeat measurement mode is set.

The Meas indicator shows that the measurement channel is performing the measurement. You will see the indicator if the measurement time is long enough to display the indicator. Even if the channel performs repeat measurement, you will not see the indicator if the time to measure one data item is too short to display the indicator.

Step 3. Setting up SMU2, forcing DC voltage, and measuring DC current

1. Press the **OutCh** key until the S-ch status area displays 2. The SMU2 setup information is displayed in the Setting Parameter area.
2. Press the **MeasCh** key until the M-ch status area displays 2. The Meas Value area displays ----- (no data to display status).
3. Press the **CPL Value** key. The cursor appears on the lowest digit of the integral part of the CPL value. The CPL shows the compliance value.
4. Press the Right arrow key to move the cursor on the arithmetic point.
5. Press the Up arrow key to set the CPL value to 100 mA, and press the **Enter** key to fix the value. Then press the **Enter** key again. The cursor disappears.
6. Press the **On/Off** key. The SMU2 starts voltage output and current measurement.

In the following example, the measured data is just an example. During the repeat measurement, you may not be able to read the measured data.

Stat	Meas Value #1	Meas Value #2	Setting Parameter	Shift
	0.00010nA		OUT: 0.00 V	
	A ▼ ▼	2 2	CPL: 100.0mA	
Remote	Lock	Meas	Trigger	Error
Integ	Output	Repeat	M-ch	S-ch

Step 4. Stopping measurement

Press the **Single** key. The SMU2 stops the measurement. However, the source output is still effective.

The LCD changes the display as shown below. The following data is just an example.

Stat	Meas Value #1	Meas Value #2	Setting Parameter	Shift
	0.00015nA		OUT: 0.00 V	
	A ▼	2 2	CPL: 100.0mA	
Remote	Lock	Meas	Trigger	Error
Integ	Output	Repeat	M-ch	S-ch

Getting Started

Step 5. Executing a spot measurement, and starting repeat measurement

1. Press the **Single** key to execute the spot measurement.
2. Press the **Repeat** key to start the repeat measurement again.

The LCD changes the display as shown below. The following data is just an example.

Stat	Meas Value #1	Meas Value #2	Setting Parameter	Shift					
	0.00025nA		OUT: 0.00 V						
	A ▼ ▼ 2 2		CPL: 100.0mA						
Err:off	Lock	Meas	Trigger	Error	Integ	Output	Repeat	M-ch	S-ch

Step 6. Changing source output value during repeat measurement

1. Press the **OUT Value** key. The cursor appears on the lowest digit of the integral part of the OUT value. OUT shows the source output value.
2. Press the arrow keys and set the OUT value to 1.500 V. The value is applied to the output immediately. Then press the **Enter** key. The cursor disappears.

Use the Up or Down arrow key to change the output value, and use the Left or Right arrow key to change the digit the cursor specifies.

The LCD changes the display as shown below. The following data is just an example.

Stat	Meas Value #1	Meas Value #2	Setting Parameter	Shift					
	0.00010nA		OUT: 1.500 V						
	A ▼ ▼ 2 2		CPL: 100.0mA						
Err:off	Lock	Meas	Trigger	Error	Integ	Output	Repeat	M-ch	S-ch

Step 7. Changing measurement item during repeat measurement

1. Press the **MeasItem** key. The voltage measurement data is also displayed as shown below. The following data is just an example.

Stat	Meas Value #1	Meas Value #2	Setting Parameter	Shift
	0.00015nA	1.50020 V	OUT: 1.500 V	
	A ▼ ▼	2 2	CPL: 100.0mA	
Remote	Lock	Meas	Trigger	Error
	Integ	Output	Repeat	M-ch
				S-ch

2. Press the **MeasItem** key. The measurement data is changed to the calculated resistance value (= *Measured Voltage / Measured Current*) as shown below. The following data is just an example.

Stat	Meas Value #1	Meas Value #2	Setting Parameter	Shift
	1.000E+13Ω		OUT: 1.500 V	
	A ▼ ▼	2 2	CPL: 100.0mA	
Remote	Lock	Meas	Trigger	Error
	Integ	Output	Repeat	M-ch
				S-ch

3. Press the **MeasItem** key. The measurement data is changed to the calculated power value (= *Measured Voltage × Measured Current*) as shown below. The following data is just an example.

Stat	Meas Value #1	Meas Value #2	Setting Parameter	Shift
	2.250E-13W		OUT: 1.500 V	
	A ▼ ▼	2 2	CPL: 100.0mA	
Remote	Lock	Meas	Trigger	Error
	Integ	Output	Repeat	M-ch
				S-ch

Getting Started

Step 8. Stopping source output and measurement

1. Press the **On/Off** key. The SMU2 stops source output and measurement.

Stat	Meas Value #1	Meas Value #2	Setting Parameter	Shift					
OFF		OUT: 1.500 V							
A ▼ 2 2		CPL: 100.0mA							
Remote	Lock	Meas	Trigger	Error	Integ	Output	Repeat	M-ch	S-ch

2. Press the **OutCh** key repeatedly until the S-ch status area displays 1. The SMU1 setup information is displayed in the Setting Parameter area.

Stat	Meas Value #1	Meas Value #2	Setting Parameter	Shift					
OFF		OUT: 0.00 V							
A ▼ ▼ 2 1		CPL: 100.0mA							
Remote	Lock	Meas	Trigger	Error	Integ	Output	Repeat	M-ch	S-ch

3. Press the **MeasCh** key repeatedly until the M-ch status area displays 1. The SMU1 measurement data is displayed in the Meas Value area.

The LCD changes the display as shown below. The following data is just an example.

Stat	Meas Value #1	Meas Value #2	Setting Parameter	Shift					
0.00030nA		OUT: 0.00 V							
A ▼ ▼ 1 1		CPL: 100.0mA							
Remote	Lock	Meas	Trigger	Error	Integ	Output	Repeat	M-ch	S-ch

4. Press the **On/Off** key. The SMU1 stops source output and measurement.

Stat	Meas Value #1	Meas Value #2	Setting Parameter	Shift					
OFF		OUT: 0.00 V							
A ▼ 1 1		CPL: 100.0mA							
Remote	Lock	Meas	Trigger	Error	Integ	Output	Repeat	M-ch	S-ch

Introduction

This chapter describes the basic functions and features of the Agilent E5270B/E5260A/E5262A/E5263A (Agilent E5260/E5270 series), and consists of the following sections:

- “Agilent E5260/E5270 Series”
- “Front View”
- “Rear View”
- “Measurement Units”
- “Specifications”
- “Accessories and Options”

Agilent E5260/E5270 Series

The Agilent E5260/E5270 series is an electronic instrument for the semiconductor DC parametric measurement. The Agilent E5260/E5270 provides the LCD and front panel keys for applying/measuring DC voltage or current. The Agilent E5260/E5270 also provides several functions, such as sweep output, pulse output, and trigger functions, in the GPIB remote condition. For these functions, refer to *Programming Guide*.

The Agilent E5260/E5270 series distributes the following products:

- Agilent E5270B 8 Slot Precision Measurement Mainframe
Equipped with a ground unit (GNDU) and eight empty slots for the following modules:
 - Agilent E5280B Precision High Power Source/Monitor Unit Module
High power SMU module for the E5270B. Occupies two slots.
 - Agilent E5281B Precision Medium Power Source/Monitor Unit Module
Medium power SMU module for the E5270B. Occupies one slot.
 - Agilent E5287A Atto Level High Resolution Source/Monitor Unit Module
High resolution SMU module for the E5270B. Occupies one slot. Needs Agilent E5288A Atto Sense and Switch Unit (ASU) to perform atto level current measurement.
- Agilent E5260A 8 Slot High Speed Measurement Mainframe
Equipped with a GNDU and eight empty slots for the following modules:
 - Agilent E5290A High Speed High Power Source/Monitor Unit Module
High power SMU module for the E5260A. Occupies two slots.
 - Agilent E5291A High Speed Medium Power Source/Monitor Unit Module
Medium power SMU module for the E5260A. Occupies one slot.
- Agilent E5262A 2 Channel (MP/MP) Source/Monitor Unit
Equipped with two high speed MPSMUs and a GNDU.
- Agilent E5263A 2 Channel (HP/MP) Source/Monitor Unit
Equipped with a high speed HPSMU, a high speed MPSMU, and a GNDU.

Front View

This section describes the front view of the Agilent E5260/E5270 series.

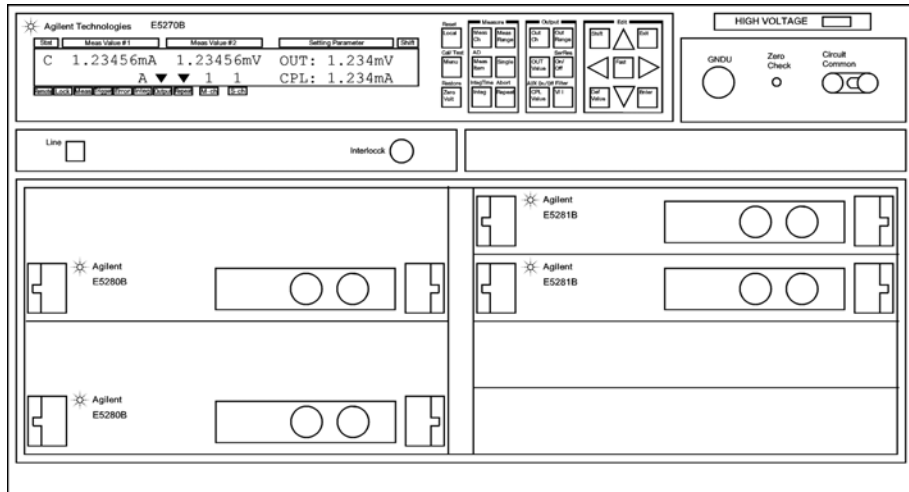



- **Line switch**
Use the Line switch to turn the E5260/E5270 on and off.
- **LCD**
Displays the status information, measurement data, source output data, and so on. For details, refer to Chapter 4, “Front Panel Reference.”
- **Front panel keys**
Use the front panel keys to set the source output, to perform measurement, and so on. For details, refer to Chapter 4, “Front Panel Reference.”
- **HIGH VOLTAGE indicator**
This indicator lights when a channel applies more than ± 42 V.
- **GNDU terminal**
0 V constant voltage source. Used for the reference of measurement ground. Triaxial connector. Refer to “GNDU - Ground Unit” on page 2-9.

- Zero Check terminal
Ground reference point of the E5260/E5270.

CAUTION

The Zero Check terminal can be used for the service purpose only. For the normal operation, leave this terminal open and do not connect anything to this terminal. Connecting anything can damage the E5260/E5270.



- Circuit Common () and Frame ground () terminals
Normally, connect the terminals together by using the shorting bar (Agilent part number 5000-4206). For floating measurement, remove the shorting bar.

CAUTION

For floating measurement, do not apply voltage more than ± 42 V to the Circuit Common terminal. Failure to heed this caution may result in damage to the Agilent E5260/E5270.

WARNING

If the Circuit Common terminal is *not* connected to the frame ground terminal (for floating measurement), a potential shock hazard may present. Do not touch any of measurement circuit at any time while a floating measurement is in progress.



- Interlock terminal
Used in conjunction with the interlock function of the E5260/E5270. If the Interlock terminal is open, maximum SMU output is limited to ± 42 V. Be sure to connect this terminal to the 16442B test fixture or connector plate before performing measurement. If you use a connector plate, you must install an interlock circuit. For details on how to install the interlock circuit, see “To Make an Interlock Circuit” on page 3-23.

WARNING

Dangerous voltage of up to the maximum voltage of SMUs may be present at force, guard, and sense terminals if the Interlock terminal is closed.

- SMU terminals
The source/monitor unit (SMU) has two triaxial connectors, force and sense, for the Kelvin connections. When you use the 16442B test fixture and Kelvin connections, up to 3 SMUs can be connected to the 16442B test fixture.

Introduction

Front View

The medium power source/monitor unit (MPSMU) and the high resolution source/monitor unit (HRSMU) occupy one slot. Hence, the MPSMU and HRSMU can be installed in any slot. Also, the channel number is same as the slot number.

The high power source/monitor unit (HPSMU) occupies two slots. Thus, the HPSMU can be installed in slots 1 to 2, 2 to 3, 3 to 4, 5 to 6, 6 to 7, or 7 to 8. The channel number is the larger slot number for the slots the HPSMU occupies. For example, if a HPSMU occupies slots 5 and 6, the channel number for the module must be 6. Channel numbers 1 and 5 are not available for the HPSMU.

NOTE

The Agilent E5270B shown above installs two HPSMUs in slots 1 to 4, and two MPSMUs in slots 5 to 6. Then the available channel numbers are 2 and 4 for the HPSMUs and 5 and 6 for the MPSMUs.

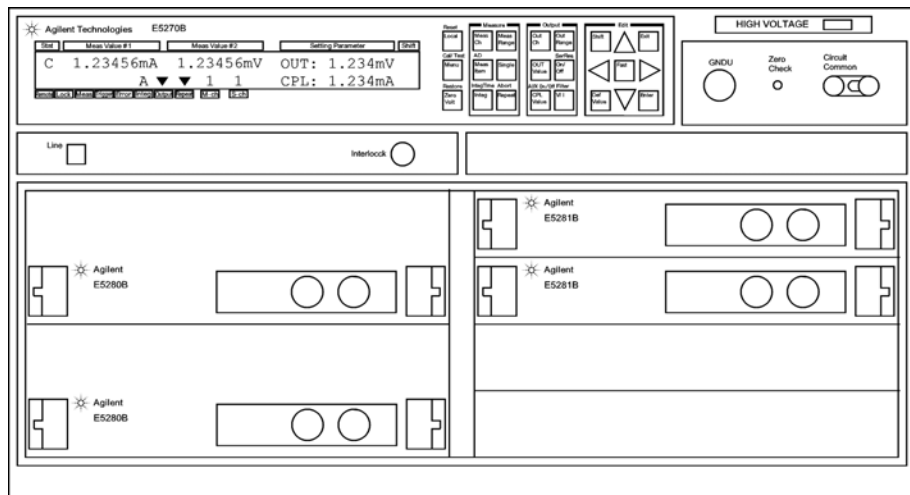

Rear View

This section describes the rear view of the Agilent E5260/E5270 series.

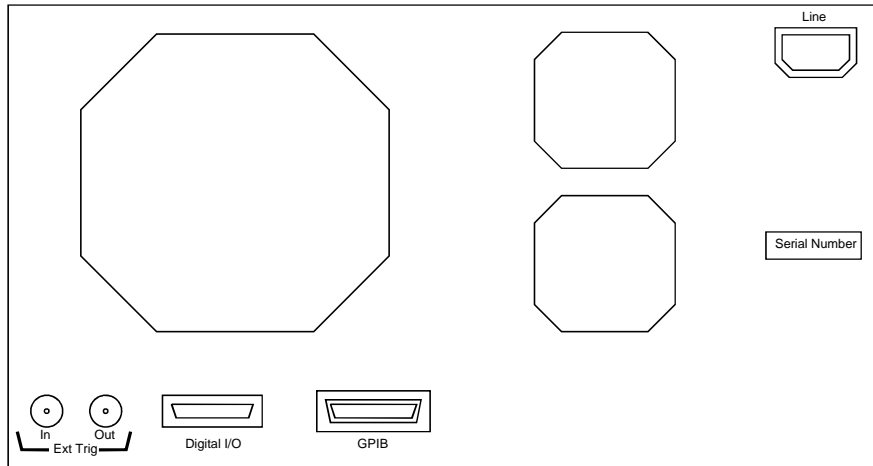

- Ext Trig terminals

Two BNC connectors, one for trigger input, and one for trigger output. For details about the trigger function, refer to *Programming Guide*. The trigger function is available for the Agilent E5260/E5270 in the GPIB remote condition.
- Digital I/O terminal

DSUB 25 pin connector. Can be used for the trigger input/output terminals or an interface to control an external relay circuit and so on. For details, refer to *Programming Guide*. The Digital I/O terminal can be used when the Agilent E5260/E5270 is in the GPIB remote condition.
- GPIB interface

Use an Agilent 82357A USB/GPIB interface or Agilent 10833A/B/C/D GPIB cable to connect to an external computer or equipment.
- LINE input receptacle

AC power cable is connected to this receptacle.
- Serial number

You need this *serial number* when using the Agilent Technologies telephone assistance program.

Measurement Units

The source/monitor unit (SMU) can force a constant voltage or current, and can measure a DC current or voltage.

Figure 2-1 is a simplified SMU circuit diagram. The SMU can perform the following operations:

- Apply voltage and measures current
- Apply current and measures voltage
- Apply voltage and measures voltage
- Apply current and measures current

NOTE

To select the SMU operation mode in the GPIB remote condition, enter the CMM command.

Figure 2-1

Simplified SMU Circuit Diagram

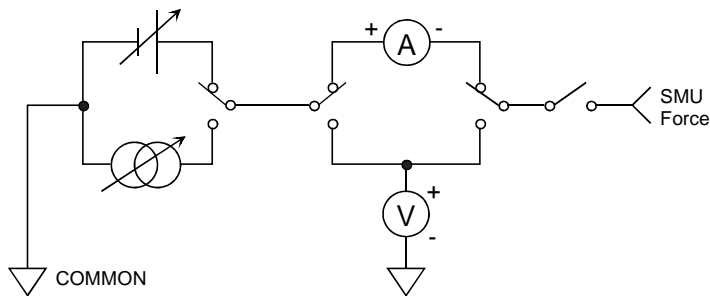

Compliance

The SMU has a compliance feature that limits output voltage or current to prevent damage to the device under test. When the SMU applies voltage, you can specify current compliance. When the SMU applies current, you can specify voltage compliance. For details about the compliance, refer to “Compliance” on page 6-9.

GNDU - Ground Unit

The Agilent E5260/E5270 is equipped with the ground unit (GNDU). The GNDU is a 0 V constant voltage source, and used for the reference of measurement ground. Also the GNDU can sink up to ± 4 A (E5260A/E5270B) or ± 2.2 A (E5262A/E5263A), so it is effective for using the HPSMU (high power SMU). Figure 2-2 is a simplified circuit diagram of GNDU.

Figure 2-2

Simplified GNDU Circuit Diagram

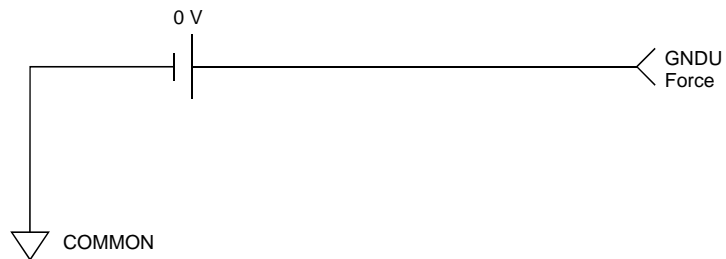

E5280B Precision HPSMU

This section describes typical specification of the high power source/monitor unit (HPSMU) for the Agilent E5270B. The E5280B cannot be used with the E5260A.

- Maximum voltage, current, output power: ± 200 V, ± 1 A, 20 W
- Minimum range: 2 V, 1 nA
- Output/measurement value and resolution: see Table 2-1 to Table 2-4.

Figure 2-3

HPSMU Output and Measurement Ranges

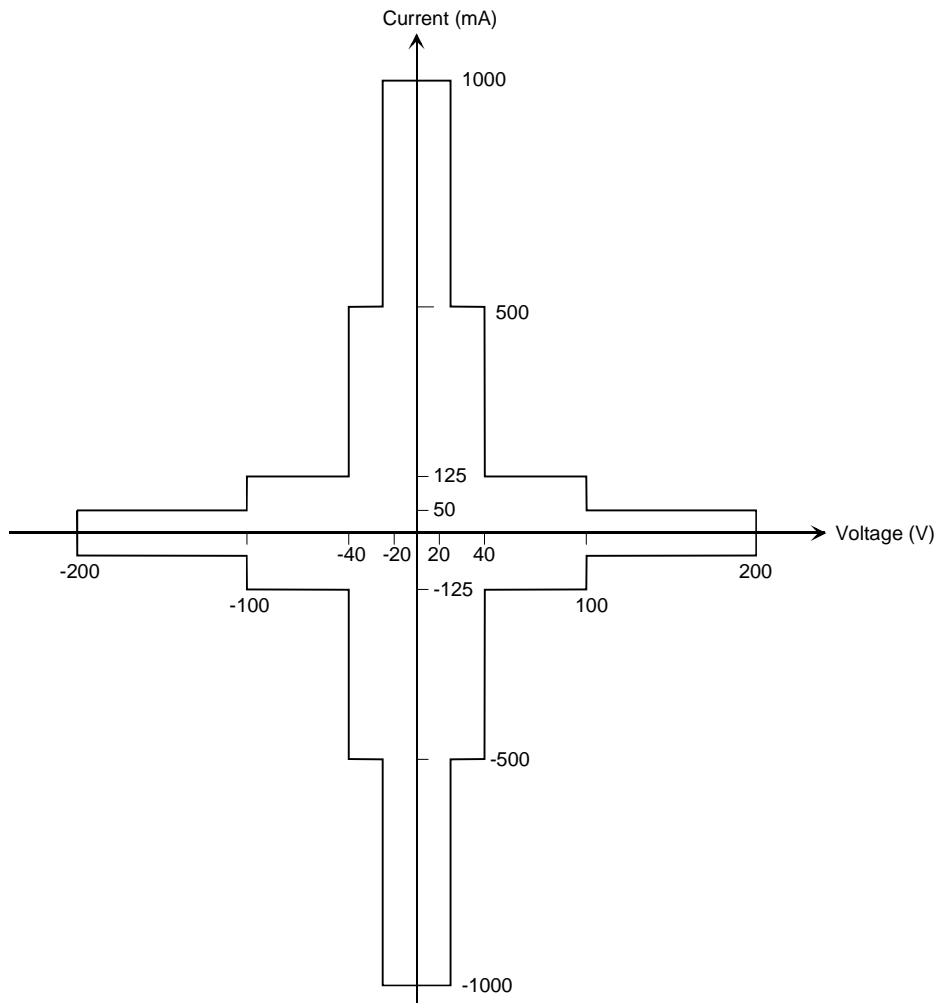

Table 2-1 HPSMU Output Voltage Ranges and Resolutions

Range	Output Value	Setting Resolution	Maximum Current
2 V	$0 \leq V \leq 2 \text{ V}$	100 μV	$\pm 1000 \text{ mA}$
20 V	$0 \leq V \leq 20 \text{ V}$	1 mV	$\pm 1000 \text{ mA}$
40 V	$0 \leq V \leq 40 \text{ V}$	2 mV	$\pm 500 \text{ mA}$
100 V	$0 \leq V \leq 100 \text{ V}$	5 mV	$\pm 125 \text{ mA}$
200 V	$0 \leq V \leq 200 \text{ V}$	10 mV	$\pm 50 \text{ mA}$

Table 2-2 HPSMU Output Current Ranges and Resolutions

Range	Output Value	Setting Resolution	Maximum Voltage
1 nA	$0 \leq I \leq 1.15 \text{ nA}$	50 fA	$\pm 200 \text{ V}$
10 nA	$0 \leq I \leq 11.5 \text{ nA}$	500 fA	$\pm 200 \text{ V}$
100 nA	$0 \leq I \leq 115 \text{ nA}$	5 pA	$\pm 200 \text{ V}$
1 μA	$0 \leq I \leq 1.15 \mu\text{A}$	50 pA	$\pm 200 \text{ V}$
10 μA	$0 \leq I \leq 11.5 \mu\text{A}$	500 pA	$\pm 200 \text{ V}$
100 μA	$0 \leq I \leq 115 \mu\text{A}$	5 nA	$\pm 200 \text{ V}$
1 mA	$0 \leq I \leq 1.15 \text{ mA}$	50 nA	$\pm 200 \text{ V}$
10 mA	$0 \leq I \leq 11.5 \text{ mA}$	500 nA	$\pm 200 \text{ V}$
100 mA	$0 \leq I \leq 50 \text{ mA}$	5 μA	$\pm 200 \text{ V}$
	$50 \text{ mA} < I \leq 115 \text{ mA}$	5 μA	$\pm 100 \text{ V}$
1 A	$0 \leq I \leq 50 \text{ mA}$	50 μA	$\pm 200 \text{ V}$
	$50 \text{ mA} < I \leq 125 \text{ mA}$	50 μA	$\pm 100 \text{ V}$
	$125 \text{ mA} < I \leq 500 \text{ mA}$	50 μA	$\pm 40 \text{ V}$
	$500 \text{ mA} < I \leq 1 \text{ A}$	50 μA	$\pm 20 \text{ V}$

Table 2-3 HPSMU Measurement Voltage Values and Resolutions

Range	Measurement Value ^a	Measurement Resolutions	
		High Speed ADC	High Resolution ADC
2 V	$0 \leq V \leq 2.2 \text{ V}$	100 μV	2 μV
20 V	$0 \leq V \leq 22 \text{ V}$	1 mV	20 μV
40 V	$0 \leq V \leq 44 \text{ V}$	2 mV	40 μV
100 V	$0 \leq V \leq 110 \text{ V}$	5 mV	100 μV
200 V	$0 \leq V \leq 200 \text{ V}$	10 mV	200 μV

Table 2-4 HPSMU Measurement Current Values and Resolutions

Range	Measurement Value ^a	Measurement Resolutions	
		High Speed ADC	High Resolution ADC
1 nA	$0 \leq I \leq 1.15 \text{ nA}$	50 fA	10 fA
10 nA	$0 \leq I \leq 11.5 \text{ nA}$	500 fA	10 fA
100 nA	$0 \leq I \leq 115 \text{ nA}$	5 pA	100 fA
1 μA	$0 \leq I \leq 1.15 \text{ } \mu\text{A}$	50 pA	1 pA
10 μA	$0 \leq I \leq 11.5 \text{ } \mu\text{A}$	500 pA	10 pA
100 μA	$0 \leq I \leq 115 \text{ } \mu\text{A}$	5 nA	100 pA
1 mA	$0 \leq I \leq 1.15 \text{ mA}$	50 nA	1 nA
10 mA	$0 \leq I \leq 11.5 \text{ mA}$	500 nA	10 nA
100 mA	$0 \leq I \leq 115 \text{ mA}$	5 μA	100 nA
1 A	$0 \leq I \leq 1 \text{ A}$	50 μA	1 μA

a. This column is applied to the auto ranging or the limited auto ranging. For fixed ranging, maximum measurement value is **Range** column value.

E5281B Precision MPSMU

This section describes typical specification of the medium power source/monitor unit (MPSMU) for the Agilent E5270B. The E5281B cannot be used with the E5260A.

- Maximum voltage, current, output power: ± 100 V, ± 100 mA, 2 W
- Minimum range: 0.5 V, 1 nA
- Output/measurement value and resolution: see Table 2-5 to Table 2-8.

Figure 2-4

MPSMU Output and Measurement Ranges

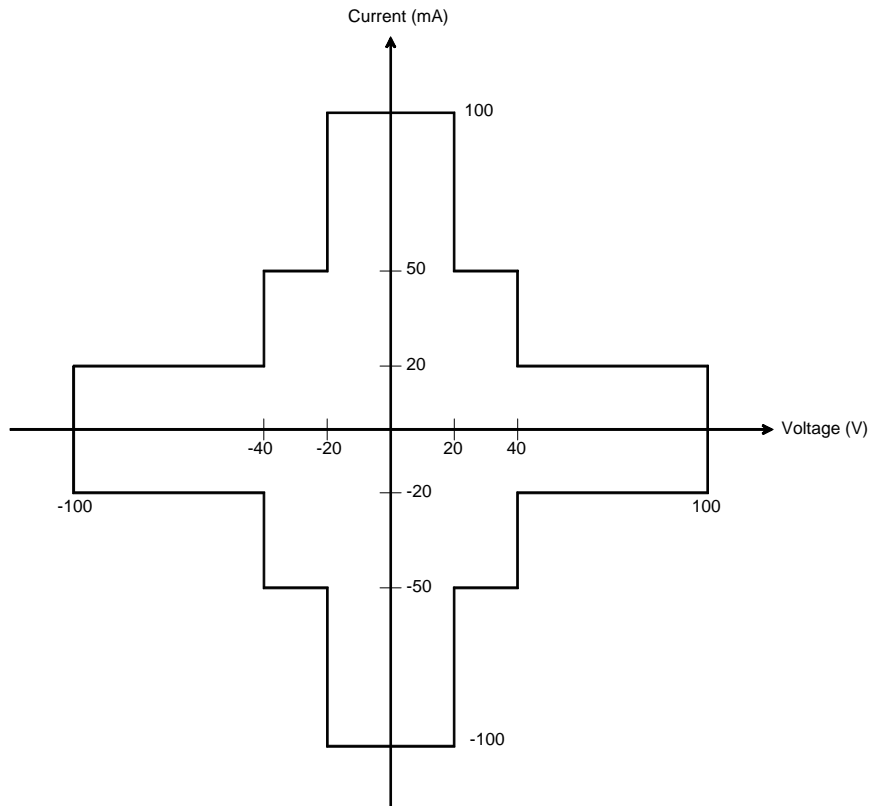

Table 2-5 **MPSMU Output Voltage Ranges and Resolutions**

Range	Output Value	Setting Resolution	Maximum Current
0.5 V	$0 \leq V \leq 0.5 \text{ V}$	25 μV	$\pm 100 \text{ mA}$
2 V	$0 \leq V \leq 2 \text{ V}$	100 μV	$\pm 100 \text{ mA}$
5 V	$0 \leq V \leq 5 \text{ V}$	250 μV	$\pm 100 \text{ mA}$
20 V	$0 \leq V \leq 20 \text{ V}$	1 mV	$\pm 100 \text{ mA}$
40 V	$0 \leq V \leq 20 \text{ V}$	2 mV	$\pm 100 \text{ mA}$
	$20 \text{ V} < V \leq 40 \text{ V}$	2 mV	$\pm 50 \text{ mA}$
100 V	$0 \leq V \leq 20 \text{ V}$	5 mV	$\pm 100 \text{ mA}$
	$20 \text{ V} < V \leq 40 \text{ V}$	5 mV	$\pm 50 \text{ mA}$
	$40 \text{ V} < V \leq 100 \text{ V}$	5 mV	$\pm 20 \text{ mA}$

Table 2-6 **MPSMU Output Current Ranges and Resolutions**

Range	Output Value	Setting Resolution	Maximum Voltage
1 nA	$0 \leq I \leq 1.15 \text{ nA}$	50 fA	$\pm 100 \text{ V}$
10 nA	$0 \leq I \leq 11.5 \text{ nA}$	500 fA	$\pm 100 \text{ V}$
100 nA	$0 \leq I \leq 115 \text{ nA}$	5 pA	$\pm 100 \text{ V}$
1 μA	$0 \leq I \leq 1.15 \mu\text{A}$	50 pA	$\pm 100 \text{ V}$
10 μA	$0 \leq I \leq 11.5 \mu\text{A}$	500 pA	$\pm 100 \text{ V}$
100 μA	$0 \leq I \leq 115 \mu\text{A}$	5 nA	$\pm 100 \text{ V}$
1 mA	$0 \leq I \leq 1.15 \text{ mA}$	50 nA	$\pm 100 \text{ V}$
10 mA	$0 \leq I \leq 11.5 \text{ mA}$	500 nA	$\pm 100 \text{ V}$
100 mA	$0 \leq I \leq 20 \text{ mA}$	5 μA	$\pm 100 \text{ V}$
	$20 \text{ mA} < I \leq 50 \text{ mA}$	5 μA	$\pm 40 \text{ V}$
	$50 \text{ mA} < I \leq 100 \text{ mA}$	5 μA	$\pm 20 \text{ V}$

Table 2-7 **MPSMU Measurement Voltage Values and Resolutions**

Range	Measurement Value ^a	Measurement Resolutions	
		High Speed ADC	High Resolution ADC
0.5 V	$0 \leq V \leq 0.55 \text{ V}$	25 μV	0.5 μV
2 V	$0 \leq V \leq 2.2 \text{ V}$	100 μV	2 μV
5 V	$0 \leq V \leq 5.5 \text{ V}$	250 μV	5 μV
20 V	$0 \leq V \leq 22 \text{ V}$	1 mV	20 μV
40 V	$0 \leq V \leq 44 \text{ V}$	2 mV	40 μV
100 V	$0 \leq V \leq 100 \text{ V}$	5 mV	100 μV

Table 2-8 **MPSMU Measurement Current Values and Resolutions**

Range	Measurement Value ^a	Measurement Resolutions	
		High Speed ADC	High Resolution ADC
1 nA	$0 \leq I \leq 1.15 \text{ nA}$	50 fA	10 fA
10 nA	$0 \leq I \leq 11.5 \text{ nA}$	500 fA	10 fA
100 nA	$0 \leq I \leq 115 \text{ nA}$	5 pA	100 fA
1 μA	$0 \leq I \leq 1.15 \text{ } \mu\text{A}$	50 pA	1 pA
10 μA	$0 \leq I \leq 11.5 \text{ } \mu\text{A}$	500 pA	10 pA
100 μA	$0 \leq I \leq 115 \text{ } \mu\text{A}$	5 nA	100 pA
1 mA	$0 \leq I \leq 1.15 \text{ mA}$	50 nA	1 nA
10 mA	$0 \leq I \leq 11.5 \text{ mA}$	500 nA	10 nA
100 mA	$0 \leq I \leq 100 \text{ mA}$	5 μA	100 nA

a. This column is applied to the auto ranging or the limited auto ranging. For fixed ranging, maximum measurement value is **Range** column value.

E5287A Atto Level HRSMU

This section describes typical specification of the high resolution source/monitor unit (HRSMU) for the Agilent E5270B. The E5287A and the E5288A Atto Sense and Switch Unit (ASU) cannot be used with the E5260A.

- Maximum voltage, current, output power: ± 100 V, ± 100 mA, 2 W
- Minimum range: 0.5 V, 10 pA (1 pA when the E5288A ASU is used)
- Output/measurement value and resolution: see Table 2-5 to Table 2-8.

Figure 2-5

HRSMU Output and Measurement Ranges

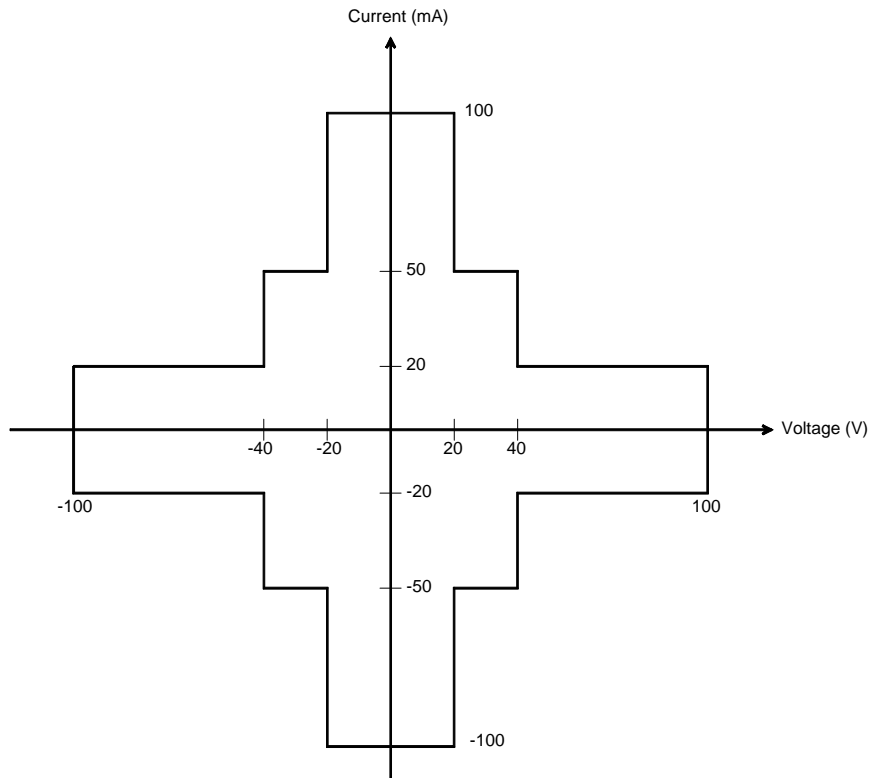

Table 2-9 HRSMU Output Voltage Ranges and Resolutions

Range	Output Value	Setting Resolution	Maximum Current
0.5 V	$0 \leq V \leq 0.5 \text{ V}$	25 μV	$\pm 100 \text{ mA}$
2 V	$0 \leq V \leq 2 \text{ V}$	100 μV	$\pm 100 \text{ mA}$
5 V	$0 \leq V \leq 5 \text{ V}$	250 μV	$\pm 100 \text{ mA}$
20 V	$0 \leq V \leq 20 \text{ V}$	1 mV	$\pm 100 \text{ mA}$
40 V	$0 \leq V \leq 20 \text{ V}$	2 mV	$\pm 100 \text{ mA}$
	$20 \text{ V} < V \leq 40 \text{ V}$	2 mV	$\pm 50 \text{ mA}$
100 V	$0 \leq V \leq 20 \text{ V}$	5 mV	$\pm 100 \text{ mA}$
	$20 \text{ V} < V \leq 40 \text{ V}$	5 mV	$\pm 50 \text{ mA}$
	$40 \text{ V} < V \leq 100 \text{ V}$	5 mV	$\pm 20 \text{ mA}$

Table 2-10 HRSMU Output Current Ranges and Resolutions

Range	Output Value	Setting Resolution	Maximum Voltage
1 pA ^a	$0 \leq I \leq 1.15 \text{ pA}$	1 fA	$\pm 100 \text{ V}$
10 pA	$0 \leq I \leq 11.5 \text{ pA}$	5 fA	$\pm 100 \text{ V}$
100 pA	$0 \leq I \leq 115 \text{ pA}$	5 fA	$\pm 100 \text{ V}$
1 nA	$0 \leq I \leq 1.15 \text{ nA}$	50 fA	$\pm 100 \text{ V}$
10 nA	$0 \leq I \leq 11.5 \text{ nA}$	500 fA	$\pm 100 \text{ V}$
100 nA	$0 \leq I \leq 115 \text{ nA}$	5 pA	$\pm 100 \text{ V}$
1 μA	$0 \leq I \leq 1.15 \mu\text{A}$	50 pA	$\pm 100 \text{ V}$
10 μA	$0 \leq I \leq 11.5 \mu\text{A}$	500 pA	$\pm 100 \text{ V}$
100 μA	$0 \leq I \leq 115 \mu\text{A}$	5 nA	$\pm 100 \text{ V}$
1 mA	$0 \leq I \leq 1.15 \text{ mA}$	50 nA	$\pm 100 \text{ V}$
10 mA	$0 \leq I \leq 11.5 \text{ mA}$	500 nA	$\pm 100 \text{ V}$
100 mA	$0 \leq I \leq 20 \text{ mA}$	5 μA	$\pm 100 \text{ V}$
	$20 \text{ mA} < I \leq 50 \text{ mA}$	5 μA	$\pm 40 \text{ V}$
	$50 \text{ mA} < I \leq 100 \text{ mA}$	5 μA	$\pm 20 \text{ V}$

a. Available when the E5288A Atto Sense and Switch Unit (ASU) is used.

Table 2-11 HRSMU Measurement Voltage Values and Resolutions

Range	Measurement Value ^a	Measurement Resolutions	
		High Speed ADC	High Resolution ADC
0.5 V	$0 \leq V \leq 0.55 \text{ V}$	25 μV	0.5 μV
2 V	$0 \leq V \leq 2.2 \text{ V}$	100 μV	2 μV
5 V	$0 \leq V \leq 5.5 \text{ V}$	250 μV	5 μV
20 V	$0 \leq V \leq 22 \text{ V}$	1 mV	20 μV
40 V	$0 \leq V \leq 44 \text{ V}$	2 mV	40 μV
100 V	$0 \leq V \leq 100 \text{ V}$	5 mV	100 μV

Table 2-12 HRSMU Measurement Current Values and Resolutions

Range	Measurement Value ^a	Measurement Resolutions	
		High Speed ADC	High Resolution ADC
1 pA ^b	$0 \leq I \leq 1.15 \text{ pA}$	100 aA	100 aA
10 pA	$0 \leq I \leq 11.5 \text{ pA}$	1 fA	1 fA
100 pA	$0 \leq I \leq 115 \text{ pA}$	5 fA	2 fA / 1 fA ^b
1 nA	$0 \leq I \leq 1.15 \text{ nA}$	50 fA	10 fA
10 nA	$0 \leq I \leq 11.5 \text{ nA}$	500 fA	10 fA
100 nA	$0 \leq I \leq 115 \text{ nA}$	5 pA	100 fA
1 μA	$0 \leq I \leq 1.15 \text{ }\mu\text{A}$	50 pA	1 pA
10 μA	$0 \leq I \leq 11.5 \text{ }\mu\text{A}$	500 pA	10 pA
100 μA	$0 \leq I \leq 115 \text{ }\mu\text{A}$	5 nA	100 pA
1 mA	$0 \leq I \leq 1.15 \text{ mA}$	50 nA	1 nA
10 mA	$0 \leq I \leq 11.5 \text{ mA}$	500 nA	10 nA
100 mA	$0 \leq I \leq 100 \text{ mA}$	5 μA	100 nA

a. This column is applied to the auto ranging or the limited auto ranging. For fixed ranging, maximum measurement value is **Range** column value.

b. Available when the E5288A Atto Sense and Switch Unit (ASU) is used.

NOTE

To connect ASU

The specifications are satisfied and guaranteed for the exclusive combination of the ASU and the HRSMU. So confirm the serial number of the ASU and connect it to the dedicated HRSMU properly.

To connect the ASU, see “To Connect ASU” on page 3-16.

To confirm the serial number, see “To Display Module Serial Number” on page 5-13.

NOTE

Before using 1 pA range

The measurement channel connected to the ASU supports the 1 pA range. To use the 1 pA range, set the 1 pA fixed range or the 1 pA limited auto ranging.

The E5270B automatically performs the compensation of the data measured by the 1 pA range and returns the compensated data. You can use either the pre-stored offset data or the pre-measured offset data.

To measure the offset data, perform the self-calibration before starting the measurement for a DUT. This offset data is temporarily memorized until the E5270B is turned off. See “To Perform Self-Calibration” on page 5-8.

E5290A High Speed HPSMU

This section describes typical specification of the high power source/monitor unit (HPSMU) for the Agilent E5260A. The E5290A cannot be used with the E5270B.

- Maximum voltage, current, output power: ± 200 V, ± 1 A, 20 W
- Minimum range: 2 V, 100 nA
- Output/measurement value and resolution: see Table 2-1 to Table 2-4.

Figure 2-6

HPSMU Output and Measurement Ranges

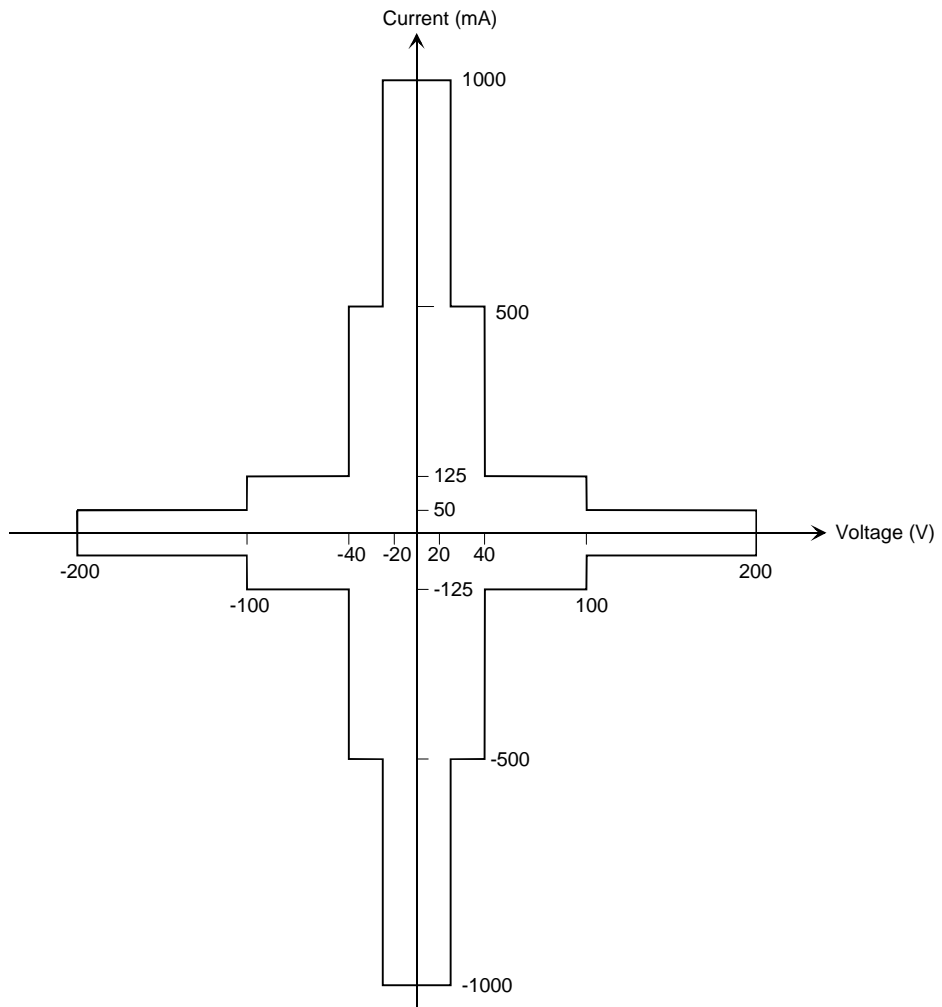

Table 2-13 HPSMU Output Voltage Ranges and Resolutions

Range	Output Value	Setting Resolution	Maximum Current
2 V	$0 \leq V \leq 2 \text{ V}$	100 μV	$\pm 1000 \text{ mA}$
20 V	$0 \leq V \leq 20 \text{ V}$	1 mV	$\pm 1000 \text{ mA}$
40 V	$0 \leq V \leq 40 \text{ V}$	2 mV	$\pm 500 \text{ mA}$
100 V	$0 \leq V \leq 100 \text{ V}$	5 mV	$\pm 125 \text{ mA}$
200 V	$0 \leq V \leq 200 \text{ V}$	10 mV	$\pm 50 \text{ mA}$

Table 2-14 HPSMU Output Current Ranges and Resolutions

Range	Output Value	Setting Resolution	Maximum Voltage
100 nA	$0 \leq I \leq 115 \text{ nA}$	5 pA	$\pm 200 \text{ V}$
1 μA	$0 \leq I \leq 1.15 \mu\text{A}$	50 pA	$\pm 200 \text{ V}$
10 μA	$0 \leq I \leq 11.5 \mu\text{A}$	500 pA	$\pm 200 \text{ V}$
100 μA	$0 \leq I \leq 115 \mu\text{A}$	5 nA	$\pm 200 \text{ V}$
1 mA	$0 \leq I \leq 1.15 \text{ mA}$	50 nA	$\pm 200 \text{ V}$
10 mA	$0 \leq I \leq 11.5 \text{ mA}$	500 nA	$\pm 200 \text{ V}$
100 mA	$0 \leq I \leq 50 \text{ mA}$	5 μA	$\pm 200 \text{ V}$
	$50 \text{ mA} < I \leq 115 \text{ mA}$	5 μA	$\pm 100 \text{ V}$
1 A	$0 \leq I \leq 50 \text{ mA}$	50 μA	$\pm 200 \text{ V}$
	$50 \text{ mA} < I \leq 125 \text{ mA}$	50 μA	$\pm 100 \text{ V}$
	$125 \text{ mA} < I \leq 500 \text{ mA}$	50 μA	$\pm 40 \text{ V}$
	$500 \text{ mA} < I \leq 1 \text{ A}$	50 μA	$\pm 20 \text{ V}$

Table 2-15 HPSMU Measurement Voltage Values and Resolutions

Range	Measurement Value ^a	Measurement Resolutions
2 V	$0 \leq V \leq 2.2 \text{ V}$	100 μV
20 V	$0 \leq V \leq 22 \text{ V}$	1 mV
40 V	$0 \leq V \leq 44 \text{ V}$	2 mV
100 V	$0 \leq V \leq 110 \text{ V}$	5 mV
200 V	$0 \leq V \leq 200 \text{ V}$	10 mV

Table 2-16 HPSMU Measurement Current Values and Resolutions

Range	Measurement Value ^a	Measurement Resolutions
100 nA	$0 \leq I \leq 115 \text{ nA}$	5 pA
1 μA	$0 \leq I \leq 1.15 \mu\text{A}$	50 pA
10 μA	$0 \leq I \leq 11.5 \mu\text{A}$	500 pA
100 μA	$0 \leq I \leq 115 \mu\text{A}$	5 nA
1 mA	$0 \leq I \leq 1.15 \text{ mA}$	50 nA
10 mA	$0 \leq I \leq 11.5 \text{ mA}$	500 nA
100 mA	$0 \leq I \leq 115 \text{ mA}$	5 μA
1 A	$0 \leq I \leq 1 \text{ A}$	50 μA

a. This column is applied to the auto ranging or the limited auto ranging. For fixed ranging, maximum measurement value is **Range** column value.

E5291A High Speed MPSMU

This section describes typical specification of the medium power source/monitor unit (MPSMU) for the Agilent E5260A. The E5291A cannot be used with the E5270B.

- Maximum voltage, current, output power: ± 100 V, ± 200 mA, 4 W
- Minimum range: 2 V, 100 nA
- Output/measurement value and resolution: see Table 2-5 to Table 2-8.

Figure 2-7

MPSMU Output and Measurement Ranges

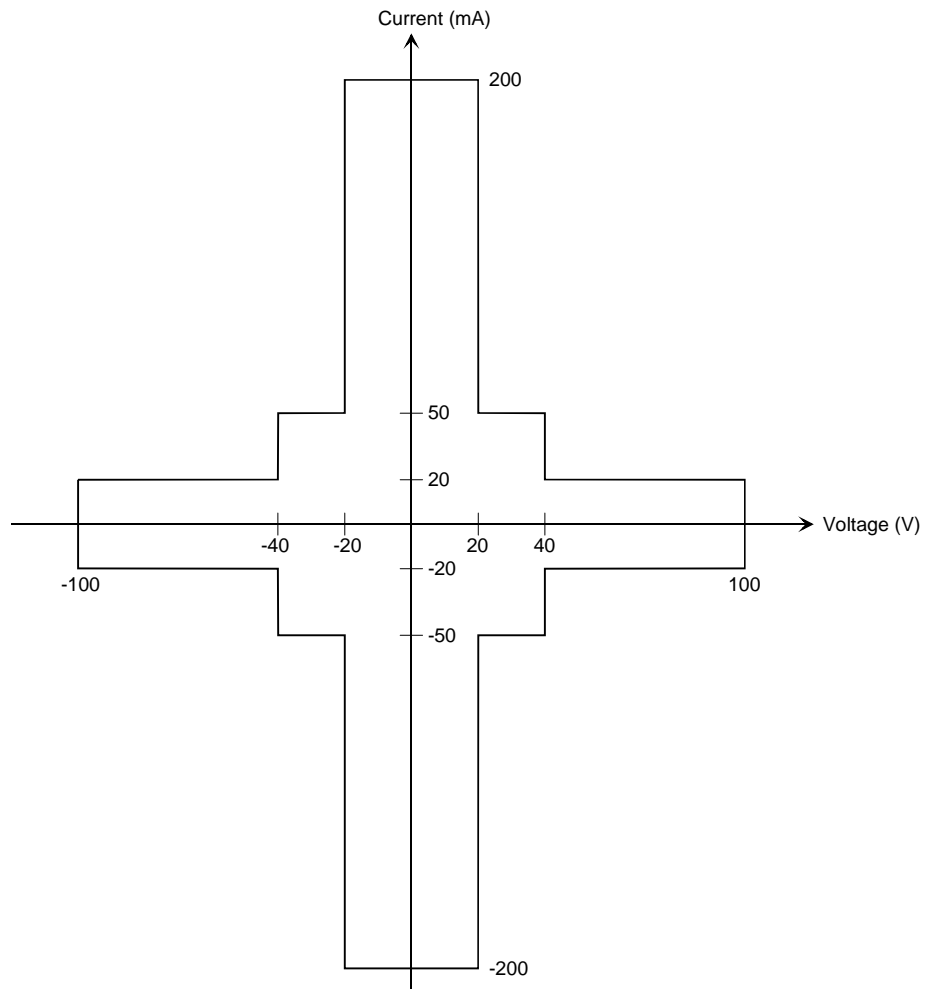

Table 2-17 **MPSMU Output Voltage Ranges and Resolutions**

Range	Output Value	Setting Resolution	Maximum Current
2 V	$0 \leq V \leq 2 \text{ V}$	100 μV	$\pm 200 \text{ mA}$
20 V	$0 \leq V \leq 20 \text{ V}$	1 mV	$\pm 200 \text{ mA}$
40 V	$0 \leq V \leq 20 \text{ V}$	2 mV	$\pm 200 \text{ mA}$
	$20 \text{ V} < V \leq 40 \text{ V}$	2 mV	$\pm 50 \text{ mA}$
100 V	$0 \leq V \leq 20 \text{ V}$	5 mV	$\pm 200 \text{ mA}$
	$20 \text{ V} < V \leq 40 \text{ V}$	5 mV	$\pm 50 \text{ mA}$
	$40 \text{ V} < V \leq 100 \text{ V}$	5 mV	$\pm 20 \text{ mA}$

Table 2-18 **MPSMU Output Current Ranges and Resolutions**

Range	Output Value	Setting Resolution	Maximum Voltage
100 nA	$0 \leq I \leq 115 \text{ nA}$	5 pA	$\pm 100 \text{ V}$
1 μA	$0 \leq I \leq 1.15 \mu\text{A}$	50 pA	$\pm 100 \text{ V}$
10 μA	$0 \leq I \leq 11.5 \mu\text{A}$	500 pA	$\pm 100 \text{ V}$
100 μA	$0 \leq I \leq 115 \mu\text{A}$	5 nA	$\pm 100 \text{ V}$
1 mA	$0 \leq I \leq 1.15 \text{ mA}$	50 nA	$\pm 100 \text{ V}$
10 mA	$0 \leq I \leq 11.5 \text{ mA}$	500 nA	$\pm 100 \text{ V}$
100 mA	$0 \leq I \leq 20 \text{ mA}$	5 μA	$\pm 100 \text{ V}$
	$20 \text{ mA} < I \leq 50 \text{ mA}$	5 μA	$\pm 40 \text{ V}$
	$50 \text{ mA} < I \leq 115 \text{ mA}$	5 μA	$\pm 20 \text{ V}$
200 mA	$0 \leq I \leq 20 \text{ mA}$	10 μA	$\pm 100 \text{ V}$
	$20 \text{ mA} < I \leq 50 \text{ mA}$	10 μA	$\pm 40 \text{ V}$
	$50 \text{ mA} < I \leq 200 \text{ mA}$	10 μA	$\pm 20 \text{ V}$

Table 2-19 **MPSMU Measurement Voltage Values and Resolutions**

Range	Measurement Value ^a	Measurement Resolutions
2 V	$0 \leq V \leq 2.2 \text{ V}$	100 μV
20 V	$0 \leq V \leq 22 \text{ V}$	1 mV
40 V	$0 \leq V \leq 44 \text{ V}$	2 mV
100 V	$0 \leq V \leq 100 \text{ V}$	5 mV

Table 2-20 **MPSMU Measurement Current Values and Resolutions**

Range	Measurement Value ^a	Measurement Resolutions
100 nA	$0 \leq I \leq 115 \text{ nA}$	5 pA
1 μA	$0 \leq I \leq 1.15 \mu\text{A}$	50 pA
10 μA	$0 \leq I \leq 11.5 \mu\text{A}$	500 pA
100 μA	$0 \leq I \leq 115 \mu\text{A}$	5 nA
1 mA	$0 \leq I \leq 1.15 \text{ mA}$	50 nA
10 mA	$0 \leq I \leq 11.5 \text{ mA}$	500 nA
100 mA	$0 \leq I \leq 115 \text{ mA}$	5 μA
200 mA	$0 \leq I \leq 200 \text{ mA}$	10 μA

- a. This column is applied to the auto ranging or the limited auto ranging. For fixed ranging, maximum measurement value is **Range** column value.

Specifications

This chapter lists specifications and supplemental information for the Agilent E5260/E5270 and its associated modules. The specifications are the standards against which the E5260/E5270 and its associated modules are tested. When the E5260/E5270 or any of its associated modules are shipped from the factory, they meet the specifications.

The “supplemental” information and “typical” entries in the following specifications are not warranted, but provide useful information about the functions and performance of the instruments.

NOTE

Never remove/install modules by yourself

Before the Agilent E5260/E5270 is shipped from the factory, the measurement modules (SMUs) are installed in the mainframe, and are tested to confirm that the Agilent E5260/E5270 satisfies the specifications.

If you remove/install the module, the specifications of the Agilent E5260/E5270 will not be guaranteed. For verifying the specifications, contact your nearest Agilent Technologies Service Center.

Introduction

The Agilent E5260A/E5270B a 8-Slot Parametric Measurement Mainframe is completely user-configurable. You can install up to eight single-slot modules (such as the medium power source monitor unit, MPSMU), up to four dual-slot modules (such as the high power source monitor unit, HPSMU), or any physically allowable combination thereof.

The Agilent E5262A and E5263A are fixed-configuration dual SMU instruments. The E5262A contains two MPSMUs, and the E5263A contains one MPSMU and one HPSMU.

Basic Features

- Performs high-speed, DC parametric measurements
- Eight slots for plug-in modules (E5260A/E5270B)
- User interface allows spot measurements to be made from the front panel
- High-resolution analog-to-digital converter (ADC) available to all installed modules (E5270B)
- High-speed analog-to-digital converter (ADC) present on each installed SMU
- Ground unit (E5260A/E5270B: 4 A, E5262A/E5263A: 2.2 A)
- SMU/AUX path switching on the Atto Sense and Switch Unit (ASU)
- BNC trigger-in and trigger-out connectors
- 16 general-purpose digital I/Os
- Program memory
- GPIB port for instrument control
- Self-test, self-calibration, diagnostics

Measurement Modes

The Agilent E5260/E5270 supports the following measurement modes:

- Spot
- Staircase Sweep
- Multi-Channel Sweep
- Pulsed Spot
- Pulsed Sweep
- Staircase Sweep with Pulsed Bias
- Quasi-pulsed Spot
- Linear Search
- Binary Search

Hardware

- “Mainframe”
- “E5280B HPSMU”
- “E5281B MPSMU”
- “E5287A HRSMU and E5288A ASU”
- “E5290A HPSMU”
- “E5291A MPSMU”
- “E5280B / E5281B / E5287A / E5290A / E5291A Supplemental Information”

Specification Conditions

The measurement and output accuracies are specified at the module connector terminals when referenced to the Zero Check terminal under the following conditions:

1. Temperature: $23\text{ }^{\circ}\text{C} \pm 5\text{ }^{\circ}\text{C}$ (double for 5 to 18 $^{\circ}\text{C}$, and for 28 to 40 $^{\circ}\text{C}$ if not noted otherwise)
2. Humidity (condition for E5270B): 15 % to 60 % (double for 60 % to 70 %)
3. After 40 minutes warm-up
4. Ambient temperature changes less than $\pm 1\text{ }^{\circ}\text{C}$ after auto calibration execution
5. Measurement made within one hour after auto calibration execution
6. Averaging (high-speed ADC): 128 samples in 1 PLC
Integration time (high-resolution ADC, condition for E5270B):
1 PLC (1 nA to 1 A range)
10 PLC (100 pA range)
50 PLC (1 pA to 10 pA range)
7. Filter: ON
8. Kelvin connection
9. Calibration period: 1 year

Mainframe

- E5260A

The E5260A supports eight slots for plug-in modules.

Module	Slots occupied	Range of operation	Measurement resolution
E5290A HPSMU	2	-200 V to 200 V, -1A to 1 A	100 μ V, 5 pA
E5291A MPSMU	1	-100 V to 100 V, -200 mA to 200 mA	100 μ V, 5 pA

- E5262A

The E5262A supports two high speed medium power SMUs (MPSMUs).

Module	Range of operation	Measurement resolution
E5291A MPSMU	-100 V to 100 V, -200 mA to 200 mA	100 μ V, 5 pA

- E5263A

The E5263A supports one high speed medium power SMU (MPSMU) and one high speed high power SMU (HPSMU).

Module	Range of operation	Measurement resolution
E5290A HPSMU	-200 V to 200 V, -1A to 1 A	100 μ V, 5 pA
E5291A MPSMU	-100 V to 100 V, -200 mA to 200 mA	100 μ V, 5 pA

Introduction
Specifications

- E5270B

The E5270B supports eight slots for plug-in modules.

Module	Slots occupied	Range of operation	Measurement resolution
E5280B HPSMU	2	-200 V to 200 V, -1A to 1 A	2 μ V, 10 fA
E5281B MPSMU	1	-100 V to 100 V, -100 mA to 100 mA	0.5 μ V, 10 fA
E5287A HRSMU	1	-100 V to 100 V, -100 mA to 100 mA	0.5 μ V, 1 fA
E5288A ASU ^a	-	-100 V to 100 V, -100 mA to 100 mA	0.5 μ V, 0.1 fA

a. The E5288A Atto Sense and Switch Unit (ASU) is connected to the E5287A Atto Level High Resolution SMU (HRSMU).

- Maximum Output Power

- E5260A/E5270A

The total module power consumption cannot exceed 80 W. Note: Using the HPSMU, MPSMU, and HRSMU, it is impossible to create a combination that exceeds the 80 Watt limit.

- E5262A/E5263A

There are no power restrictions. Both mainframes support having both of their modules simultaneously output maximum voltage or current.

- Maximum Voltage between Common and Ground

≤ 42 V

- Pulse Measurement

Width 500 μ s to 2 s

Period 5 ms to 5 s

Period \geq Width+2 ms (when Width \leq 100 ms)

Period \geq Width+10 ms (when Width $>$ 100 ms)

Resolution 100 μ s

- Ground Unit (GNDU)

The GNDU is furnished with the mainframe.

Output voltage 0 V \pm 100 μ V

Maximum sink current E5260A/E5270B: 4 A
E5262A/E5263A: 2.2 A

Output terminal / connection Triaxial connector, Kelvin (remote sensing)

Load capacitance 1 μ F (supplemental information)

Cable resistance

Terminal	Cable resistance (supplemental information)
Sense	$\leq 10 \Omega$
Force	$< 1 \Omega$ ($I_s \leq 1.6 \text{ A}$) $< 0.7 \Omega$ ($1.6 \text{ A} < I_s \leq 2.0 \text{ A}$) $< 0.35 \Omega$ ($2.0 \text{ A} < I_s$) I_s is the current being sunk by the GNDU.

E5280B HPSMU

- Voltage Range, Resolution, and Accuracy

Refer to Table 2-21.

- Current Range, Resolution, and Accuracy

Refer to Table 2-22.

- Power Consumption

Voltage source mode:

Voltage Range	Power Consumption ^a
2 V	$I_c \times 20 \text{ W}$
20 V	$I_c \times 20 \text{ W}$
40 V	$I_c \times 40 \text{ W}$
100 V	$I_c \times 100 \text{ W}$
200 V	$I_c \times 200 \text{ W}$

a. I_c is the current compliance setting.

Current source mode:

Voltage Compliance ^a	Power Consumption ^b
$V_c \leq 20 \text{ V}$	$I_o \times 20 \text{ W}$
$20 \text{ V} < V_c \leq 40 \text{ V}$	$I_o \times 40 \text{ W}$
$40 \text{ V} < V_c \leq 100 \text{ V}$	$I_o \times 100 \text{ W}$
$100 \text{ V} < V_c \leq 200 \text{ V}$	$I_o \times 200 \text{ W}$

a. V_c is the voltage compliance setting.

b. I_o is the output current.

- Output terminal/connection: Triaxial connector, Kelvin (remote sensing)
- Voltage/Current Compliance (Limiting)

Voltage Compliance 0 V to $\pm 200 \text{ V}$

Current Compliance $\pm 1 \text{ pA}$ to $\pm 1 \text{ A}$

Compliance Accuracy Same as the current or voltage set accuracy.

Table 2-21 Voltage Range, Resolution, and Accuracy (E5280B)

Voltage Range	Force Resolution	Measurement Resolution		Force Accuracy $\pm (\% + \text{mV})^a$	Measurement Accuracy $\pm (\% + \text{mV})^a$		Maximum Current
		High Speed ADC	High Resolution ADC		High Speed ADC	High Resolution ADC	
$\pm 2 \text{ V}$	100 μV	100 μV	2 μV	$\pm (0.03 + 0.9)$	$\pm (0.03 + 0.7)$	$\pm (0.02 + 0.7)$	1 A
$\pm 20 \text{ V}$	1 mV	1 mV	20 μV	$\pm (0.03 + 4)$	$\pm (0.03 + 4)$	$\pm (0.02 + 2)$	1 A
$\pm 40 \text{ V}$	2 mV	2 mV	40 μV	$\pm (0.03 + 7)$	$\pm (0.03 + 8)$	$\pm (0.02 + 3)$	500 mA
$\pm 100 \text{ V}$	5 mV	5 mV	100 μV	$\pm (0.04 + 15)$	$\pm (0.03 + 20)$	$\pm (0.03 + 5)$	125 mA
$\pm 200 \text{ V}$	10 mV	10 mV	200 μV	$\pm (0.045 + 30)$	$\pm (0.035 + 40)$	$\pm (0.035 + 10)$	50 mA

a. $\pm(\%$ of output/measured value + offset value in mV)

Table 2-22 Current Range, Resolution, and Accuracy (E5280B)

Current Range	Force Resolution	Measurement Resolution		Force Accuracy $\pm (\%+A+A)^a$	Measurement Accuracy $\pm (\%+A+A)^a$	Maximum Voltage
		High Speed ADC	High Resolution ADC			
$\pm 1 \text{ nA}$	50 fA	50 fA	10 fA	$\pm (0.5+3E^{-12}+V_o \times 2E^{-15})$	$\pm (0.5+3E^{-12}+V_o \times 2E^{-15})$	200 V
$\pm 10 \text{ nA}$	500 fA	500 fA	10 fA	$\pm (0.5+7E^{-12}+V_o \times 2E^{-14})$	$\pm (0.5+5E^{-12}+V_o \times 2E^{-14})$	200 V
$\pm 100 \text{ nA}$	5 pA	5 pA	100 fA	$\pm (0.12+5E^{-11}+V_o \times 2E^{-13})$	$\pm (0.1+3E^{-11}+V_o \times 2E^{-13})$	200 V
$\pm 1 \mu\text{A}$	50 pA	50 pA	1 pA	$\pm (0.12+4E^{-10}+V_o \times 2E^{-12})$	$\pm (0.1+2E^{-10}+V_o \times 2E^{-12})$	200 V
$\pm 10 \mu\text{A}$	500 pA	500 pA	10 pA	$\pm (0.12+5E^{-9}+V_o \times 2E^{-11})$	$\pm (0.1+3E^{-9}+V_o \times 2E^{-11})$	200 V
$\pm 100 \mu\text{A}$	5 nA	5 nA	100 pA	$\pm (0.12+4E^{-8}+V_o \times 2E^{-10})$	$\pm (0.1+2E^{-8}+V_o \times 2E^{-10})$	200 V
$\pm 1 \text{ mA}$	50 nA	50 nA	1 nA	$\pm (0.12+5E^{-7}+V_o \times 2E^{-9})$	$\pm (0.1+3E^{-7}+V_o \times 2E^{-9})$	200 V
$\pm 10 \text{ mA}$	500 nA	500 nA	10 nA	$\pm (0.12+4E^{-6}+V_o \times 2E^{-8})$	$\pm (0.1+2E^{-6}+V_o \times 2E^{-8})$	200 V
$\pm 100 \text{ mA}$	5 μA	5 μA	100 nA	$\pm (0.12+5E^{-5}+V_o \times 2E^{-7})$	$\pm (0.1+3E^{-5}+V_o \times 2E^{-7})$	b
$\pm 1 \text{ A}$	50 μA	50 μA	1 μA	$\pm (0.5+5E^{-4}+V_o \times 2E^{-6})$	$\pm (0.1+3E^{-4}+V_o \times 2E^{-6})$	

a. $\pm(\%$ of output/measured value + fixed offset in A + proportional offset in A), V_o is the output voltage in V.

b. 200 V ($I_o \leq 50 \text{ mA}$), 100 V ($50 \text{ mA} < I_o \leq 125 \text{ mA}$), 40 V ($125 \text{ mA} < I_o \leq 500 \text{ mA}$), 20 V ($500 \text{ mA} < I_o \leq 1 \text{ A}$), I_o is the output current.

E5281B MPSMU

- Voltage Range, Resolution, and Accuracy

Refer to Table 2-23.

- Current Range, Resolution, and Accuracy

Refer to Table 2-24.

- Power Consumption

Voltage source mode:

Voltage Range	Power Consumption ^a
0.5 V	$I_c \times 20 \text{ W}$
2 V	$I_c \times 20 \text{ W}$
5 V	$I_c \times 20 \text{ W}$
20 V	$I_c \times 20 \text{ W}$
40 V	$I_c \times 40 \text{ W}$
100 V	$I_c \times 100 \text{ W}$

a. I_c is the current compliance setting.

Current source mode:

Voltage Compliance ^a	Power Consumption ^b
$V_c \leq 20 \text{ V}$	$I_o \times 20 \text{ W}$
$20 \text{ V} < V_c \leq 40 \text{ V}$	$I_o \times 40 \text{ W}$
$40 \text{ V} < V_c \leq 100 \text{ V}$	$I_o \times 100 \text{ W}$

a. V_c is the voltage compliance setting.

b. I_o is the output current.

- Output terminal/connection: Triaxial connector, Kelvin (remote sensing)
- Voltage/Current Compliance (Limiting)

Voltage Compliance 0 V to $\pm 100 \text{ V}$

Current Compliance $\pm 1 \text{ pA}$ to $\pm 100 \text{ mA}$

Compliance Accuracy Same as the current or voltage set accuracy.

Table 2-23 Voltage Range, Resolution, and Accuracy (E5281B)

Voltage Range	Force Resolution	Measurement Resolution		Force Accuracy $\pm (\% + \text{mV})^a$	Measurement Accuracy $\pm (\% + \text{mV})^a$		Maximum Current
		High Speed ADC	High Resolution ADC		High Speed ADC	High Resolution ADC	
$\pm 0.5 \text{ V}$	$25 \mu\text{V}$	$25 \mu\text{V}$	$0.5 \mu\text{V}$	$\pm (0.03 + 0.35)$	$\pm (0.03 + 0.25)$	$\pm (0.02 + 0.25)$	100 mA
$\pm 2 \text{ V}$	$100 \mu\text{V}$	$100 \mu\text{V}$	$2 \mu\text{V}$	$\pm (0.03 + 0.9)$	$\pm (0.03 + 0.7)$	$\pm (0.02 + 0.7)$	100 mA
$\pm 5 \text{ V}$	$250 \mu\text{V}$	$250 \mu\text{V}$	$5 \mu\text{V}$	$\pm (0.03 + 2)$	$\pm (0.03 + 2)$	$\pm (0.02 + 1)$	100 mA
$\pm 20 \text{ V}$	1 mV	1 mV	$20 \mu\text{V}$	$\pm (0.03 + 4)$	$\pm (0.03 + 4)$	$\pm (0.02 + 2)$	100 mA
$\pm 40 \text{ V}$	2 mV	2 mV	$40 \mu\text{V}$	$\pm (0.03 + 7)$	$\pm (0.03 + 8)$	$\pm (0.02 + 3)$	b
$\pm 100 \text{ V}$	5 mV	5 mV	$100 \mu\text{V}$	$\pm (0.04 + 15)$	$\pm (0.03 + 20)$	$\pm (0.03 + 5)$	

a. \pm (% of output/measured value + offset value in mV)

b. 100 mA ($V_o \leq 20 \text{ V}$), 50 mA ($20 \text{ V} < V_o \leq 40 \text{ V}$), 20 mA ($40 \text{ V} < V_o$), V_o is the output voltage.

Table 2-24 Current Range, Resolution, and Accuracy (E5281B)

Current Range	Force Resolution	Measurement Resolution		Force Accuracy $\pm (\% + A + A)^a$	Measurement Accuracy $\pm (\% + A + A)^a$	Maximum Voltage
		High Speed ADC	High Resolution ADC			
$\pm 1 \text{ nA}$	50 fA	50 fA	10 fA	$\pm (0.5 + 3E^{-12} + V_o \times 2E^{-15})$	$\pm (0.5 + 3E^{-12} + V_o \times 2E^{-15})$	100 V
$\pm 10 \text{ nA}$	500 fA	500 fA	10 fA	$\pm (0.5 + 7E^{-12} + V_o \times 2E^{-14})$	$\pm (0.5 + 5E^{-12} + V_o \times 2E^{-14})$	100 V
$\pm 100 \text{ nA}$	5 pA	5 pA	100 fA	$\pm (0.12 + 5E^{-11} + V_o \times 2E^{-13})$	$\pm (0.1 + 3E^{-11} + V_o \times 2E^{-13})$	100 V
$\pm 1 \mu\text{A}$	50 pA	50 pA	1 pA	$\pm (0.12 + 4E^{-10} + V_o \times 2E^{-12})$	$\pm (0.1 + 2E^{-10} + V_o \times 2E^{-12})$	100 V
$\pm 10 \mu\text{A}$	500 pA	500 pA	10 pA	$\pm (0.12 + 5E^{-9} + V_o \times 2E^{-11})$	$\pm (0.1 + 3E^{-9} + V_o \times 2E^{-11})$	100 V
$\pm 100 \mu\text{A}$	5 nA	5 nA	100 pA	$\pm (0.12 + 4E^{-8} + V_o \times 2E^{-10})$	$\pm (0.1 + 2E^{-8} + V_o \times 2E^{-10})$	100 V
$\pm 1 \text{ mA}$	50 nA	50 nA	1 nA	$\pm (0.12 + 5E^{-7} + V_o \times 2E^{-9})$	$\pm (0.1 + 3E^{-7} + V_o \times 2E^{-9})$	100 V
$\pm 10 \text{ mA}$	500 nA	500 nA	10 nA	$\pm (0.12 + 4E^{-6} + V_o \times 2E^{-8})$	$\pm (0.1 + 2E^{-6} + V_o \times 2E^{-8})$	100 V
$\pm 100 \text{ mA}$	$5 \mu\text{A}$	$5 \mu\text{A}$	100 nA	$\pm (0.12 + 5E^{-5} + V_o \times 2E^{-7})$	$\pm (0.1 + 3E^{-5} + V_o \times 2E^{-7})$	b

a. \pm (% of output/measured value + fixed offset in A + proportional offset in A), V_o is the output voltage in V.

b. 100 V ($I_o \leq 20 \text{ mA}$), 40 V ($20 \text{ mA} < I_o \leq 50 \text{ mA}$), 20 V ($50 \text{ mA} < I_o$), I_o is the output current.

E5287A HRSMU and E5288A ASU

- Voltage Range, Resolution, and Accuracy

Refer to Table 2-25.

- Current Range, Resolution, and Accuracy

Refer to Table 2-26. For the measurement resolution, minimum 1 aA display resolution at 1 pA range by 6 digits. Specified measurement resolution is limited by fundamental noise limits.

- Power Consumption

Voltage source mode:

Voltage Range	Power Consumption ^a	Voltage Range	Power Consumption ^a
0.5 V	$I_c \times 20 \text{ W}$	20 V	$I_c \times 20 \text{ W}$
2 V	$I_c \times 20 \text{ W}$	40 V	$I_c \times 40 \text{ W}$
5 V	$I_c \times 20 \text{ W}$	100 V	$I_c \times 100 \text{ W}$

a. I_c is the current compliance setting.

Current source mode:

Voltage Compliance ^a	Power Consumption ^b
$V_c \leq 20 \text{ V}$	$I_o \times 20 \text{ W}$
$20 \text{ V} < V_c \leq 40 \text{ V}$	$I_o \times 40 \text{ W}$
$40 \text{ V} < V_c \leq 100 \text{ V}$	$I_o \times 100 \text{ W}$

a. V_c is the voltage compliance setting.

b. I_o is the output current.

- Output terminal/connection: Triaxial connector, Kelvin (remote sensing)
- Voltage/Current Compliance (Limiting)

Voltage Compliance 0 V to $\pm 100 \text{ V}$

Current Compliance $\pm 10 \text{ fA}$ to $\pm 100 \text{ mA}$ (with ASU)
 $\pm 100 \text{ fA}$ to $\pm 100 \text{ mA}$ (without ASU)

Compliance Accuracy Same as the current or voltage set accuracy.

Table 2-25 Voltage Range, Resolution, and Accuracy (E5287A)

Voltage Range	Force Resolution	Measurement Resolution		Force Accuracy $\pm (\% + \text{mV})^a$	Measurement Accuracy $\pm (\% + \text{mV})^a$		Maximum Current
		High Speed ADC	High Resolution ADC		High Speed ADC	High Resolution ADC	
$\pm 0.5 \text{ V}$	$25 \mu\text{V}$	$25 \mu\text{V}$	$0.5 \mu\text{V}$	$\pm (0.02 + 0.15)$	$\pm (0.01 + 0.25)$	$\pm (0.01 + 0.15)$	100 mA
$\pm 2 \text{ V}$	$100 \mu\text{V}$	$100 \mu\text{V}$	$2 \mu\text{V}$	$\pm (0.02 + 0.4)$	$\pm (0.01 + 0.7)$	$\pm (0.01 + 0.2)$	100 mA
$\pm 5 \text{ V}$	$250 \mu\text{V}$	$250 \mu\text{V}$	$5 \mu\text{V}$	$\pm (0.02 + 0.75)$	$\pm (0.01 + 2)$	$\pm (0.01 + 0.25)$	100 mA
$\pm 20 \text{ V}$	1 mV	1 mV	$20 \mu\text{V}$	$\pm (0.02 + 3)$	$\pm (0.01 + 4)$	$\pm (0.01 + 1)$	100 mA
$\pm 40 \text{ V}$	2 mV	2 mV	$40 \mu\text{V}$	$\pm (0.025 + 6)$	$\pm (0.015 + 8)$	$\pm (0.015 + 2)$	b
$\pm 100 \text{ V}$	5 mV	5 mV	$100 \mu\text{V}$	$\pm (0.03 + 15)$	$\pm (0.02 + 20)$	$\pm (0.02 + 5)$	

a. $\pm(\%$ of output/measured value + offset value in mV)

b. 100 mA ($V_o \leq 20 \text{ V}$), 50 mA ($20 \text{ V} < V_o \leq 40 \text{ V}$), 20 mA ($40 \text{ V} < V_o$), V_o is the output voltage.

Table 2-26 Current Range, Resolution, and Accuracy (E5287A)

Current Range	Force Resolution	Measurement Resolution		Force Accuracy $\pm (\% + \text{A} + \text{A})^a$	Measurement Accuracy $\pm (\% + \text{A} + \text{A})^a$	Maximum Voltage
		High Speed ADC	High Resolution ADC			
$\pm 1 \text{ pA}^b$	1 fA	100 aA	100 aA	$\pm (1.8 + 15\text{E}^{-15})$	$\pm (1.8 + 12\text{E}^{-15})$	100 V
$\pm 10 \text{ pA}$	5 fA	1 fA	1 fA	$\pm (0.5 + 40\text{E}^{-15} + V_o \times 1\text{E}^{-17})$	$\pm (0.5 + 15\text{E}^{-15} + V_o \times 1\text{E}^{-17})$	100 V
$\pm 100 \text{ pA}$	5 fA	5 fA	$2 \text{ fA} / 1 \text{ fA}^b$	$\pm (0.5 + 12\text{E}^{-14} + V_o \times 1\text{E}^{-16})$	$\pm (0.5 + 4\text{E}^{-14} + V_o \times 1\text{E}^{-16})$	100 V
$\pm 1 \text{ nA}$	50 fA	50 fA	10 fA	$\pm (0.25 + 4\text{E}^{-13} + V_o \times 1\text{E}^{-15})$	$\pm (0.25 + 3\text{E}^{-13} + V_o \times 1\text{E}^{-15})$	100 V
$\pm 10 \text{ nA}$	500 fA	500 fA	10 fA	$\pm (0.25 + 4\text{E}^{-12} + V_o \times 1\text{E}^{-14})$	$\pm (0.25 + 2\text{E}^{-12} + V_o \times 1\text{E}^{-14})$	100 V
$\pm 100 \text{ nA}$	5 pA	5 pA	100 fA	$\pm (0.12 + 4\text{E}^{-11} + V_o \times 1\text{E}^{-13})$	$\pm (0.1 + 2\text{E}^{-11} + V_o \times 1\text{E}^{-13})$	100 V
$\pm 1 \mu\text{A}$	50 pA	50 pA	1 pA	$\pm (0.12 + 4\text{E}^{-10} + V_o \times 1\text{E}^{-12})$	$\pm (0.1 + 2\text{E}^{-10} + V_o \times 1\text{E}^{-12})$	100 V
$\pm 10 \mu\text{A}$	500 pA	500 pA	10 pA	$\pm (0.07 + 4\text{E}^{-9} + V_o \times 1\text{E}^{-11})$	$\pm (0.05 + 2\text{E}^{-9} + V_o \times 1\text{E}^{-11})$	100 V
$\pm 100 \mu\text{A}$	5 nA	5 nA	100 pA	$\pm (0.07 + 4\text{E}^{-8} + V_o \times 1\text{E}^{-10})$	$\pm (0.05 + 2\text{E}^{-8} + V_o \times 1\text{E}^{-10})$	100 V
$\pm 1 \text{ mA}$	50 nA	50 nA	1 nA	$\pm (0.06 + 4\text{E}^{-7} + V_o \times 1\text{E}^{-9})$	$\pm (0.04 + 2\text{E}^{-7} + V_o \times 1\text{E}^{-9})$	100 V
$\pm 10 \text{ mA}$	500 nA	500 nA	10 nA	$\pm (0.06 + 4\text{E}^{-6} + V_o \times 1\text{E}^{-8})$	$\pm (0.04 + 2\text{E}^{-6} + V_o \times 1\text{E}^{-8})$	100 V
$\pm 100 \text{ mA}$	$5 \mu\text{A}$	$5 \mu\text{A}$	100 nA	$\pm (0.12 + 4\text{E}^{-5} + V_o \times 1\text{E}^{-7})$	$\pm (0.1 + 2\text{E}^{-5} + V_o \times 1\text{E}^{-7})$	c

a. $\pm(\%$ of output/measured value + fixed offset in A + proportional offset in A), V_o is the output voltage in V.

b. Available when the Agilent E5288A Atto Sense and Switch Unit (ASU) is used.

c. 100 V ($I_o \leq 20 \text{ mA}$), 40 V ($20 \text{ mA} < I_o \leq 50 \text{ mA}$), 20 V ($50 \text{ mA} < I_o$), I_o is the output current.

E5288A Atto Sense and Switch Unit (ASU).

AUX Path Specification

- Maximum Voltage
 - 100 V (AUX input to AUX common)
 - 100 V (AUX input to circuit common)
 - 42 V (AUX common to circuit common)
- Maximum Current
 - 0.5 A (AUX input to Force output)

ASU Supplemental Information

- Band width (at -3 dB):
 - < 30 MHz (AUX port)

NOTE**Connect ASU to dedicated HRSMU**

The specifications are satisfied and guaranteed for the exclusive combination of the ASU and the HRSMU. So confirm the serial number of the ASU and connect it to the dedicated HRSMU properly.

E5290A HPSMU

- Voltage Range, Resolution, and Accuracy

Refer to Table 2-27.

- Current Range, Resolution, and Accuracy

Refer to Table 2-28.

- Power Consumption

Voltage source mode:

Voltage Range	Power Consumption ^a
2 V	$I_c \times 20 \text{ W}$
20 V	$I_c \times 20 \text{ W}$
40 V	$I_c \times 40 \text{ W}$
100 V	$I_c \times 100 \text{ W}$
200 V	$I_c \times 200 \text{ W}$

a. I_c is the current compliance setting.

Current source mode:

Voltage Compliance ^a	Power Consumption ^b
$V_c \leq 20 \text{ V}$	$I_o \times 20 \text{ W}$
$20 \text{ V} < V_c \leq 40 \text{ V}$	$I_o \times 40 \text{ W}$
$40 \text{ V} < V_c \leq 100 \text{ V}$	$I_o \times 100 \text{ W}$
$100 \text{ V} < V_c \leq 200 \text{ V}$	$I_o \times 200 \text{ W}$

a. V_c is the voltage compliance setting.

b. I_o is the output current.

- Output terminal/connection: Triaxial connector, Kelvin (remote sensing)
- Voltage/Current Compliance (Limiting)

Voltage Compliance 0 V to $\pm 200 \text{ V}$

Current Compliance $\pm 100 \text{ pA}$ to $\pm 1 \text{ A}$

Compliance Accuracy Same as the current or voltage set accuracy.

Table 2-27 Voltage Range, Resolution, and Accuracy (E5290A)

Voltage Range	Force/Measurement Resolution	Force Accuracy \pm (% + mV) ^a	Measurement Accuracy \pm (% + mV) ^a	Maximum Current
\pm 2 V	100 μ V	\pm (0.03 + 0.9)	\pm (0.03 + 0.7)	1 A
\pm 20 V	1 mV	\pm (0.03 + 4)	\pm (0.03 + 4)	1 A
\pm 40 V	2 mV	\pm (0.03 + 7)	\pm (0.03 + 8)	500 mA
\pm 100 V	5 mV	\pm (0.04 + 15)	\pm (0.03 + 20)	125 mA
\pm 200 V	10 mV	\pm (0.045 + 30)	\pm (0.035 + 40)	50 mA

a. \pm (% of output/measured value + offset value in mV)

Table 2-28 Current Range, Resolution, and Accuracy (E5290A)

Current Range	Force/Measurement Resolution	Force Accuracy \pm (%+A+A) ^a	Measurement Accuracy \pm (%+A+A) ^a	Maximum Voltage
\pm 100 nA	5 pA	\pm (0.12+5E ⁻¹¹ +V _p ×5E ⁻¹²)	\pm (0.1+3E ⁻¹¹ +V _p ×5E ⁻¹²)	200 V
\pm 1 μ A	50 pA	\pm (0.12+4E ⁻¹⁰ +V _p ×5E ⁻¹¹)	\pm (0.1+2E ⁻¹⁰ +V _p ×5E ⁻¹¹)	200 V
\pm 10 μ A	500 pA	\pm (0.12+5E ⁻⁹ +V _p ×5E ⁻¹⁰)	\pm (0.1+3E ⁻⁹ +V _p ×5E ⁻¹⁰)	200 V
\pm 100 μ A	5 nA	\pm (0.12+4E ⁻⁸ +V _p ×5E ⁻⁹)	\pm (0.1+2E ⁻⁸ +V _p ×5E ⁻⁹)	200 V
\pm 1 mA	50 nA	\pm (0.12+5E ⁻⁷ +V _p ×5E ⁻⁸)	\pm (0.1+3E ⁻⁷ +V _p ×5E ⁻⁸)	200 V
\pm 10 mA	500 nA	\pm (0.12+4E ⁻⁶ +V _p ×5E ⁻⁷)	\pm (0.1+2E ⁻⁶ +V _p ×5E ⁻⁷)	200 V
\pm 100 mA	5 μ A	\pm (0.12+5E ⁻⁵ +V _p ×5E ⁻⁶)	\pm (0.1+3E ⁻⁵ +V _p ×5E ⁻⁶)	b
\pm 1 A	50 μ A	\pm (0.5+5E ⁻⁴ +V _p ×5E ⁻⁵)	\pm (0.5+3E ⁻⁴ +V _p ×5E ⁻⁵)	

a. \pm (% of output/measured value + fixed offset in A + proportional offset in A), V_o is the output voltage in V, V_p is V_o/25. For the V_p value, the decimal point must be rounded out.

b. 200 V (I_o ≤ 50 mA), 100 V (50 mA < I_o ≤ 125 mA), 40 V (125 mA < I_o ≤ 500 mA), 20 V (500 mA < I_o ≤ 1 A), I_o is the output current.

E5291A MPSMU

- Voltage Range, Resolution, and Accuracy

Refer to Table 2-29.

- Current Range, Resolution, and Accuracy

Refer to Table 2-30.

- Power Consumption

Voltage source mode:

Voltage Range	Power Consumption ^a
2 V	$I_c \times 20 \text{ W}$
20 V	$I_c \times 20 \text{ W}$
40 V	$I_c \times 40 \text{ W}$
100 V	$I_c \times 100 \text{ W}$

- a. I_c is the current compliance setting.

Current source mode:

Voltage Compliance ^a	Power Consumption ^b
$V_c \leq 20 \text{ V}$	$I_o \times 20 \text{ W}$
$20 \text{ V} < V_c \leq 40 \text{ V}$	$I_o \times 40 \text{ W}$
$40 \text{ V} < V_c \leq 100 \text{ V}$	$I_o \times 100 \text{ W}$

- a. V_c is the voltage compliance setting.

- b. I_o is the output current.

- Output terminal/connection: Triaxial connector, Kelvin (remote sensing)
- Voltage/Current Compliance (Limiting)

Voltage Compliance 0 V to $\pm 100 \text{ V}$

Current Compliance $\pm 100 \text{ pA}$ to $\pm 200 \text{ mA}$

Compliance Accuracy Same as the current or voltage set accuracy.

Table 2-29 Voltage Range, Resolution, and Accuracy (E5291A)

Voltage Range	Force/Measurement Resolution	Force Accuracy \pm (% + mV) ^a	Measurement Accuracy \pm (% + mV) ^a	Maximum Current
\pm 2 V	100 μ V	\pm (0.03 + 0.9)	\pm (0.03 + 0.7)	200 mA
\pm 20 V	1 mV	\pm (0.03 + 4)	\pm (0.03 + 4)	200 mA
\pm 40 V	2 mV	\pm (0.03 + 7)	\pm (0.03 + 8)	b
\pm 100 V	5 mV	\pm (0.04 + 15)	\pm (0.03 + 20)	

a. \pm (% of output/measured value + offset value in mV)

b. 200 mA ($V_o \leq 20$ V), 50 mA (20 V < $V_o \leq 40$ V), 20 mA (40 V < V_o), V_o is the output voltage.

Table 2-30 Current Range, Resolution, and Accuracy (E5291A)

Current Range	Force/Measurement Resolution	Force Accuracy \pm (%+A+A) ^a	Measurement Accuracy \pm (%+A+A) ^a	Maximum Voltage
\pm 100 nA	5 pA	\pm (0.12+5E ⁻¹¹ +V _p ×5E ⁻¹²)	\pm (0.1+3E ⁻¹¹ +V _p ×5E ⁻¹²)	100 V
\pm 1 μ A	50 pA	\pm (0.12+4E ⁻¹⁰ +V _p ×5E ⁻¹¹)	\pm (0.1+2E ⁻¹⁰ +V _p ×5E ⁻¹¹)	100 V
\pm 10 μ A	500 pA	\pm (0.12+5E ⁻⁹ +V _p ×5E ⁻¹⁰)	\pm (0.1+3E ⁻⁹ +V _p ×5E ⁻¹⁰)	100 V
\pm 100 μ A	5 nA	\pm (0.12+4E ⁻⁸ +V _p ×5E ⁻⁹)	\pm (0.1+2E ⁻⁸ +V _p ×5E ⁻⁹)	100 V
\pm 1 mA	50 nA	\pm (0.12+5E ⁻⁷ +V _p ×5E ⁻⁸)	\pm (0.1+3E ⁻⁷ +V _p ×5E ⁻⁸)	100 V
\pm 10 mA	500 nA	\pm (0.12+4E ⁻⁶ +V _p ×5E ⁻⁷)	\pm (0.1+2E ⁻⁶ +V _p ×5E ⁻⁷)	100 V
\pm 100 mA	5 μ A	\pm (0.12+5E ⁻⁵ +V _p ×5E ⁻⁶)	\pm (0.1+3E ⁻⁵ +V _p ×5E ⁻⁶)	b
\pm 200 mA	10 μ A	\pm (0.12+1E ⁻⁴ +V _p ×1E ⁻⁵)	\pm (0.1+6E ⁻⁵ +V _p ×1E ⁻⁵)	

a. \pm (% of output/measured value + fixed offset in A + proportional offset in A), V_o is the output voltage in V, V_p is $V_o/25$, V_{px} is $V_o/50$. For the V_p and V_{px} values, the decimal point must be rounded out.

b. 100 V ($I_o \leq 20$ mA), 40 V (20 mA < $I_o \leq 50$ mA), 20 V (50 mA < I_o), I_o is the output current.

E5280B / E5281B / E5287A / E5290A / E5291A Supplemental Information

- Maximum allowable cable resistance (Kelvin connection)

Terminal	Cable resistance
Sense	10 Ω
Force	10 Ω ($I \leq 100$ mA) 1.5 Ω (100 mA < I)

- Voltage source output resistance (Force line, Non-Kelvin connection)
0.2 Ω (E5280B/E5290A)
0.3 Ω (E5281B/E5287A/E5291A)
- Voltage measurement input resistance: $\geq 10^{13}$ Ω
- Current source output resistance: $\geq 10^{13}$ Ω (1 nA range)
- Current compliance setting accuracy (for opposite polarity)

Current range	Accuracy
1 pA to 10 nA	Setting accuracy ± 12 % of range
≥ 100 nA	Setting accuracy ± 2.5 % of range

- Maximum capacitive load

Current range	Maximum capacitive load
1 pA to 10 nA	1000 pF
100 nA to 10 mA	10 nF
≥ 100 mA	100 μ F

- Maximum guard capacitance:
900 pF (E5280B/E5281B/E5287A/E5290A/E5291A)
660 pF (E5287A with ASU)

Introduction

Specifications

- Maximum shield capacitance:
5000 pF (E5280B/E5281B/E5287A/E5290A/E5291A)
3500 pF (E5287A with ASU)
- Maximum guard offset voltage:
 ± 1 mV (E5280B/E5290A/E5291A)
 ± 3 mV (E5281B/E5287A)
 ± 4.2 mV (E5287A with ASU, $I_{out} \leq 100 \mu\text{A}$)
- Noise characteristics (filter ON)
Voltage source: 0.01 % of V range (rms.)
Current source: 0.1 % of I range (rms.)
- Overshoot (filter ON)
Voltage source: 0.03 % of V range
Current source: 1 % of I range
- Range switching transient noise (filter ON)
Voltage ranging: 250 mV
Current ranging: 10 mV
- Slew rate: 0.2 V/ μs (maximum)
- SMU pulse setting accuracy (fixed measurement range)
Width 0.5 % + 50 μs
Period 0.5 % + 100 μs
- Trigger output delay (pulsed measurements)
0 to 32.7 ms with 100 μs resolution
Trigger output delay must be less than pulse width.

Functions

- Front Panel Operations
 - Display
 - Display error messages
 - Display spot measurement set value
 - Display spot measurement result
 - Keypad Operations
 - Set GPIB address
 - Set local/remote mode
 - Select measurement channel
 - Set spot measurement set value
 - ASU input (SMU/AUX) switching (E5270B)
 - Start calibration/diagnostics
- MPSMU and HPSMU Measurement Mode Details
 - Spot Measurement

Applies voltage or current, then measures voltage or current. A maximum of eight measurement channels can be used.
 - Staircase Sweep Measurement

Applies staircase sweep voltage or current, and measures voltage or current at each sweep step. A maximum of eight measurement channels can be used, and an extra sweep source forces the staircase sweep output synchronized to the primary sweep output.

Number of Steps: 1 to 1,001

Hold Time: 0 to 655.35s, 1 ms resolution

Delay Time: 0 to 65.5350s, 100 μ s resolution

Introduction

Specifications

- Multi Channel Sweep Measurement

Applies staircase sweep voltage or current using multiple sweep sources, and performs staircase sweep measurement. A maximum of eight sweep sources and eight measurement channels can be used.

Number of Steps: 1 to 1,001

Hold Time: 0 to 655.35s, 1 ms resolution

Delay Time: 0 to 65.5350s, 100 μ s resolution

- Pulsed Spot Measurement

Applies pulsed voltage or current, and measures voltage or current.

Pulse Width: 500 μ s to 2 s, 100 μ s resolution

Pulse Period: 5 ms to 5 s, 100 μ s resolution.

- Period \geq Width+2 ms (when Width \leq 100 ms)

- Period \geq Width+10 ms (when Width $>$ 100 ms)

Maximum Pulse Duty: 50%

- Pulsed Sweep Measurement

Applies pulsed sweep voltage or current, and measures voltage or current at each sweep step. An extra sweep source can be used to force the staircase sweep output synchronized to the pulsed sweep output.

- Staircase Sweep with Pulsed Bias Measurement

Applies pulsed voltage or current, and performs staircase sweep measurement. The staircase sweep output is synchronized to the pulsed bias. A synchronous staircase sweep source is also available.

- Quasi-pulsed Spot Measurement

Applies quasi-pulsed voltage or current, and measures voltage or current.

- Search Measurement (linear search and binary search)

Applies voltage or current, and measures voltage or current. Repeats this for various output values until the search stop condition is satisfied. Synchronous output is available.

- Time Stamp

The E5260/E5270 supports a time stamp function utilizing an internal quartz clock.

Resolution: 100 μ s

- Program Memory

The E5260/E5270 mainframe contains (volatile) memory that can be used to increase test measurement throughput. Program memory allows the storage of program code in the E5260/E5270, eliminating the need to communicate over the GPIB interface. In addition, input data can be passed to code sequences stored in program memory.

- Maximum lines of Storable Code: 40,000
- Maximum number of program sequences: 2,000

- Output Data Buffer

The number of data points that can be stored in the data buffer varies with the choice of the output data format.

Minimum number of Storable Data Points: 34,034

- Trigger I/O

Trigger in/out synchronization pulses before and after setting and measuring DC voltage and current. Arbitrary trigger events can be masked or activated independently.

- Input

Input Level: TTL level, negative or positive edge trigger, or TTL level, negative or positive gate trigger.

An external trigger input signal can be used to do any of the following:

1. Start a measurement.
2. Start a measurement at each sweep step for a staircase sweep or multi channel sweep measurement.
3. Start the source output at each sweep step for a staircase sweep, pulsed sweep, staircase sweep with pulsed bias, or multi channel sweep measurement.
4. Start the pulsed output for a pulsed spot measurement.
5. Recover from a wait state.

Introduction

Specifications

- Output

Output Level: TTL level, negative or positive edge trigger, or TTL level, negative or positive gate trigger.

An output trigger signal can be sent when one of the following events occurs:

1. The end of a measurement is reached.
2. The end of a measurement at each sweep step for a staircase sweep or multi channel sweep measurement is reached.
3. Completion of the source output setup at each sweep step for a staircase sweep, pulsed sweep, staircase sweep with pulsed bias, or multi channel sweep measurement.
4. Completion of the pulsed output setup for a pulsed spot measurement.
5. A trigger command is issued.

- Trigger Terminals

Ext Trig In/Out (BNC) and Digital I/O port can be used for trigger I/O.

- General Purpose Digital I/O

16 general-purpose digital I/O signals are available via a 25-pin DIN connector. These pins can be used as an alternative to the BNC trigger-in and trigger-out lines to synchronize the E5260/E5270 with other instruments. They can also be used as output and input ports for digital signals. The user can selectively assign pins to trigger mode or digital I/O mode.

- Furnished Software

- *VXIplug&play* driver
- TIS library (only for E5270B)

Supported operating systems:

Microsoft® Windows® 95, NT, 2000, and XP Professional

General Specifications

- Temperature Range
 - Operating** +5 °C to +40 °C
 - Storage** -20 °C to +60 °C
- Humidity
 - Operating** 15 % to 80 %RH (E5260)
15 % to 70 %RH (E5270B)
non-condensing
 - Storage** 5 % to 90 %RH (E5260)
5 % to 80 %RH (E5270B, at 50 °C)
non-condensing
- Altitude
 - Operating** 0 to 2,000 m (6,561 ft.)
 - Storage** 0 to 4,600 m (15,092 ft.)
- Power Requirement: 90 to 264 V, 47 to 63 Hz
- Maximum Volt-Amps (VA):
600 VA (E5260A/E5270B), 400 VA (E5262A/E5263A)
- Regulatory Compliance
 - EMC** IEC61326-1 / EN61326-1
AS/NZS CISPR 11
 - Safety** CSA C22.2 No.1010.1-1992
IEC61010-1 / EN61010-1
UL Std No. 61010B-1
- Certification: CE, CSA(c/us), C-Tick
- Dimensions
 - E5260A/E5270B: 426 mm (W) × 235 mm (H) × 575 mm (D)
 - E5262A/E5263A: 426 mm (W) × 150 mm (H) × 575 mm (D)
- Weight
 - 17 kg (E5260A/E5270B mainframe), 15 kg (E5262A), 16 kg (E5263A),
2.5 kg (E5280B/E5290A), 1.4 kg (E5281B), 1.5 kg (E5287A), 0.5 kg (E5288A),
1.6 kg (E5291A)

Accessories and Options

The Agilent E5260/E5270 is furnished with the following accessories.

- Power Cable, 1 ea.
- Operation Summary Sheet, 1 ea.
- Software CD, 1ea.

Table 2-31 lists the options and the available accessories for the Agilent E5260/E5270.

Table 2-31 Options and Accessories

Model Number	Option Item	Description
E5260A		8 Slot High Speed Measurement Mainframe
	E5260A-050	50 Hz power line frequency
	E5260A-060	60 Hz power line frequency
	E5260A-A6J	ANSI Z540 compliant calibration
	E5260A-UK6	Commercial cal. certificate w/ test data
	E5260A-ABA	Manual set, English
	E5260A-ABJ	Manual set, Japanese
E5262A		2 Channel Source/Monitor Unit (MPSMU/MPSMU)
	E5262A-050	50 Hz power line frequency
	E5262A-060	60 Hz power line frequency
	E5262A-A6J	ANSI Z540 compliant calibration
	E5262A-UK6	Commercial cal. certificate w/ test data
	E5262A-ABA	Manual set, English
	E5262A-ABJ	Manual set, Japanese
E5263A		2 Channel Source/Monitor Unit (HPSMU/MPSMU)
	E5263A-050	50 Hz power line frequency
	E5263A-060	60 Hz power line frequency
	E5263A-A6J	ANSI Z540 compliant calibration
	E5263A-UK6	Commercial cal. certificate w/ test data
	E5263A-ABA	Manual set, English
	E5263A-ABJ	Manual set, Japanese

Introduction
Accessories and Options

Model Number	Option Item	Description
E5270B		8 Slot Precision Measurement Mainframe
	E5270B-050	50 Hz power line frequency
	E5270B-060	60 Hz power line frequency
	E5270B-A6J	ANSI Z540 compliant calibration
	E5270B-UK6	Commercial cal. certificate w/ test data
	E5270B-ABA	Manual set, English
	E5270B-ABJ	Manual set, Japanese
E5280B		Precision High Power Source/Monitor Unit Module for Agilent E5270B
E5281B		Precision Medium Power Source/Monitor Unit Module for Agilent E5270B
E5287A		Atto Level High Resolution Source/Monitor Unit Module for Agilent E5270B
E5288A		Atto Sense and Switch Unit for Agilent E5287A
E5290A		High Speed High Power Source/Monitor Unit Module for Agilent E5260A
E5291A		High Speed Medium Power Source/Monitor Unit Module for Agilent E5260A
N1253A		Digital I/O accessories
	N1253A-100	Digital I/O T-cable
	N1253A-200	Digital I/O BNC Box
N1254A		Accessories
	N1254A-100	GNDU to Kelvin Adapter
	N1254A-107	Triax(m)-Triax(f) Adapter
	N1254A-108	ASU Magnetic Stand

Model Number	Option Item	Description
16442B		Test Fixture
	16442B-010	Add 1.5 m triaxial cables, 4 ea.
	16442B-011	Add 3.0 m triaxial cables, 4 ea.
	16442B-800	Extra blank teflon board
	16442B-801	Universal socket module, 0.1 inch pitch, with 10 pins
	16442B-802	Universal socket module, 0.075 inch pitch, with 10 pins
	16442B-803	Universal socket module, 0.05 inch pitch, with 10 pins
	16442B-810	Extra pin set (for universal socket module, 10 pins.)
	16442B-811	Extra wire set (mini banana to pin plug, 6 ea.)
	16442B-812	Extra wire set (pin plug to pin plug, 6 ea.)
	16442B-813	Extra wire set (mini banana to mini clip, 6 ea.)
	16442B-814	Extra wire set (mini banana to mini banana, 6 ea.)
	16442B-821	Socket module, 4-pin TO package
	16442B-822	Socket module, 18-pin DIP package
	16442B-823	Extra socket module, 28-pin DIP package
16442B-890	Extra accessory case	
16493G		Digital I/O Connection Cable
	16493G-001	1.5 m length
	16493G-002	3.0 m length
16493J		Interlock Cable
	16493J-001	1.5 m length
	16493J-002	3.0 m length
16493K		Kelvin Triaxial Cable (E5260/E5270 Kelvin to E5260/E5270 Kelvin)
	16493K-001	1.5 m length
	16493K-002	3.0 m length
16493L		GNDU Cable for E5260/E5270 series
	16493L-001	1.5 m length
	16493L-002	3.0 m length

Introduction
Accessories and Options

Model Number	Option Item	Description
16493M		Triaxial and D-sub Cable for ASU
	16493M-001	1.5 m length
	16493M-002	3.0 m length
16494A		Triaxial Cable
	16494A-001	1.5 m length
	16494A-002	3 m length
	16494A-003	80 cm length
16494B		Kelvin Triaxial Cable (E5260/E5270 to E5250 input)
	16494B-001	1.5 m length
	16494B-002	3 m length
	16494B-003	80 cm length
16495F		Connector plate w/ 12×triax., Interlock, GNDU
	16495F-001	Bulkhead feedthrough connectors (female to female)
	16495F-002	Connectors to contacts for soldering
16495G		Connector plate w/ 24×triax., Interlock, GNDU
	16495G-001	Bulkhead feedthrough connectors (female to female)
	16495G-002	Connectors to contacts for soldering
16495H		Connector plate w/ 6×triax., 6×coax., Interlock, GNDU
	16495H-001	Bulkhead feedthrough connectors (female to female)
	16495H-002	Connectors to contacts for soldering
16495J		Connector plate w/ 8×triax., 4×coax., Interlock, GNDU
	16495J-001	Bulkhead feedthrough connectors (female to female)
	16495J-002	Connectors to contacts for soldering
16495K		Connector Plate with Universal Cable Holder
	16495K-001	Connector Plate with Rubber Holder

3

Installation

Installation

This chapter describes how to install Agilent E5260/E5270 and accessories.

- “Requirements”
- “Inspection and Installation”
- “Installing Accessories”
- “Mounting Connectors”
- “Connecting Measurement Devices”
- “Maintenance”

WARNING



There are potentially hazardous voltages (200 V for HPSMU, and 100 V for MPSMU) present at the Force, Guard, and Sense terminals of the Agilent E5260/E5270. To prevent electrical shock, the following safety precautions must be observed during the use of the Agilent E5260/E5270.

- Use a three-conductor AC power cable to connect the cabinet (if used) and the Agilent E5260/E5270 to an electrical ground (safety ground).
 - If you do *not* use the 16442B test fixture, you must install and connect an interlock circuit that opens the Interlock terminal when the shielding box access door is opened.
 - Confirm periodically that the interlock function works normally.
 - Before touching the connections on the Force, Guard, and Sense terminals, turn the Agilent E5260/E5270 off and discharge any capacitors. If you do *not* turn the Agilent E5260/E5270 off, complete *all* of the following items, regardless of the Agilent E5260/E5270 settings.
 - Press the OutCh and On/Off keys, and confirm that the Output status indicator is not lit for all source channels.
 - Confirm that the HIGH VOLTAGE indicator is not lit.
 - Open the shielding box access door (open the Interlock terminal).
 - Discharge any capacitors connected to an SMU.
 - Warn persons working around the Agilent E5260/E5270 about dangerous conditions.
-

Requirements

This section contains information on:

- “Power Requirements”
- “Operating Environment”
- “Storing/Shipping Environment”
- “Ventilation Requirements”
- “Power Cable”

Power Requirements

The Agilent E5260/E5270 can operate from any single-phase AC power source supplying 90 to 264 V at 47 to 63 Hz. The maximum power consumption is 600 VA for the Agilent E5260A/E5270B, and 400 VA for the Agilent E5262A/E5263A. For details, see “Specifications” on page 2-26.

Operating Environment

The Agilent E5260/E5270 is specified to operate within the following environmental conditions:

Temperature:	5 °C to 35 °C
Humidity:	5 % to 70 % RH, non-condensing
Altitude:	0 to 2,000 m (6,561 ft.)

Storing/Shipping Environment

The Agilent E5260/E5270 is specified to store/ship within the following environmental conditions:

Temperature:	-20 °C to 60 °C
Humidity:	< 80 % RH, non-condensing
Altitude:	0 to 15,240 m (50,000 ft.)

Ventilation Requirements

The Agilent E5260/E5270 has cooling fans. To ensure adequate airflow, make sure that there is sufficient clearance around the cooling fans: 6 inches (150 mm) behind, 3 inches (70 mm) on the sides, and 0.5 inch (12 mm) above and below.

If the airflow is restricted, the internal operating temperature will be higher. This may reduce the instrument's reliability, or cause the thermal-protection circuits to turn the instrument off.

Power Cable

CAUTION

Before applying AC line power to the Agilent E5260/E5270, ensure that the correct power cable is used.

In accordance with international safety standards, this instrument is equipped with a three-prong power cable. When connected to an appropriate AC power outlet, this cable grounds the instrument frame. The type of power cable shipped with each instrument depends on the country of destination. Refer to the following table for the Agilent part numbers of the power cables available.











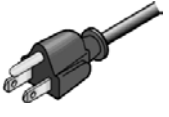

If the plug on the cable does not fit the power outlet, or the cable is to be attached to a terminal block, cut the cable at the plug end and re-wire it. This work should be performed by a qualified electrician, observing all local electrical codes.

The color coding used in the cable will depend on the cable supplied. If a new plug is to be connected, it must meet local safety requirements and include the following features:

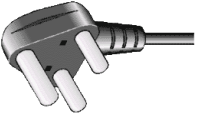
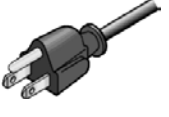
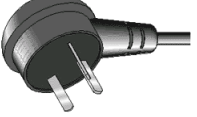
- adequate load-carrying capacity (see “Specifications” on page 2-26.)
- ground connection
- cable clamp

WARNING

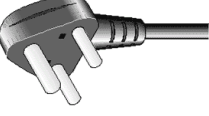
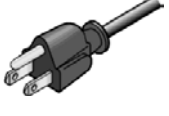
For protection from electrical shock, do *not* interrupt the power cable ground.

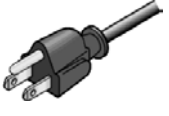
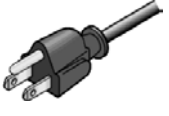
 <ul style="list-style-type: none"> • Plug: BS 1363/A, 250 V, 10 A • PN: 8120-4420 	 <ul style="list-style-type: none"> • Plug: AS 3112, 250 V, 10 A • PN: 8120-4419 	 <ul style="list-style-type: none"> • Plug: CEE 7 sheet VII, 250 V, 10 A • PN: 8120-4519 	 <ul style="list-style-type: none"> • Plug: NEMA 5-15P, 125 V, 10 A • PN: 8120-6825
 <ul style="list-style-type: none"> • Plug: NEMA 6-15P, 250 V, 10 A • PN: 8120-3996, 8120-0698 	 <ul style="list-style-type: none"> • Plug: SEV 1011, 250 V, 10 A • PN: 8120-2104 	 <ul style="list-style-type: none"> • Plug: SR 107-2-D1, 250 V, 10 A • PN: 8120-2956 	 <ul style="list-style-type: none"> • Plug: IS 1293 and IS 6538, 250 V, 10 A • PN: 8120-4211
 <ul style="list-style-type: none"> • Plug: JIS C 8303, 125 V, 12 A • PN: 8121-0743 	 <ul style="list-style-type: none"> • Plug: Israel SI 32, 250 V, 10 A • PN: 8120-5182 	 <ul style="list-style-type: none"> • Plug: IRAM 2073-10A, 250 V, 10 A • PN: 8120-6870 	 <ul style="list-style-type: none"> • Plug: CEI 23-16, 250 V, 10 A • PN: 8120-6978
 <ul style="list-style-type: none"> • Plug: GB 1002 figure 3, 250 V, 10 A • PN: 8120-8376 	 <ul style="list-style-type: none"> • Plug: SANS 164-1, 250 V, 10 A • PN: 8120-4211, 8121-0564 	 <ul style="list-style-type: none"> • Plug: TISI 166, 250 V, 10 A • PN: 8121-1866 	 <ul style="list-style-type: none"> • Plug: NBR 14136, 250 V, 10 A • PN: 8121-1809
 <ul style="list-style-type: none"> • Plug: CNS 10917-2, 125 V, 10 A • PN: 8120-6825, 8121-1635 	 <ul style="list-style-type: none"> • Plug: CS 0017:2003, 250 V, 10 A • PN: 8120-8871, 8121-1638 		

Inspection and Installation

This section describes what to do when you receive the Agilent E5260/E5270 and accessories.

1. Inspect the shipment. See “To Inspect the Agilent E5260/E5270 and Accessories”.
2. Verify the Agilent E5260/E5270 operation. See “To Check the Agilent E5260/E5270 Operation” and “To Execute Diagnostics and Self-calibration”.

After the normal condition and operation are confirmed, install the Agilent E5260/E5270 in the place that satisfies the requirements described in the previous section.

To Inspect the Agilent E5260/E5270 and Accessories

Perform the following inspections when the Agilent E5260/E5270 and accessories arrive at your site.

1. Before unpacking any components, inspect all boxes for any signs of damage that might have occurred during shipment, such as:
 - dents
 - scratches
 - cuts
 - water marks

If you suspect any damage, notify your local Agilent Technologies sales or service office.

2. When you open the boxes that contain the Agilent E5260/E5270 and accessories, check the components against the contents lists attached to the boxes.

If anything is missing, notify your local Agilent Technologies sales or service office.

To Check the Agilent E5260/E5270 Operation

1. Make sure that the Line switch is set to off.
2. On the Agilent E5260/E5270 front panel, connect the Circuit Common terminal to the frame ground terminal by using a shorting-bar.

WARNING

If the Circuit Common terminal is *not* connected to the frame ground terminal (for floating measurement), a potential shock hazard may present. Do not touch any of measurement circuit at any time while a floating measurement is in progress.

3. Connect the power cable from the Agilent E5260/E5270 to an AC power outlet.
4. Press the Line switch to turn on the Agilent E5260/E5270.

The initialization screen will appear on the display of the Agilent E5260/E5270. And the power-on self-test is automatically executed.

If the Agilent E5260/E5270 is operating correctly, the LCD displays as shown in Figure 3-1.

If a problem occurs, see *If You Have a Problem* manual.

5. Press the **Menu** key, and select CONFIG and UNIT menu. Then make sure that the units displayed match the units installed.
6. Press the **Exit** key three times to close the setup menu.

Figure 3-1

LCD Display Example

Stat	Meas Value #1	Meas Value #2	Setting Parameter	Shift
	OFF		OUT: 0.00 V	
	A	1 1	CPL: 100.0uA	
Remote	Lock	Meas	Trigger	Error
Integ	Output	Repeat	M-ch	S-ch

To Execute Diagnostics and Self-calibration

Perform the following functions as necessary.

Self-test See “To Perform Self-test” on page 5-7.

Self-calibration See “To Perform Self-Calibration” on page 5-8.

Diagnostics See “To Perform Diagnostics” on page 5-9.

To Remove or Install Plug-in Module

This section provides the plug-in module removal and installation instructions.

WARNING

To prevent electrical shock, turn off the mainframe and remove the power cable before starting the instruction.

CAUTION

Be careful about the interconnection connector and use clean handling and anti-static procedures when unpacking or doing the following procedure to prevent damage.

NOTE

Plug-in module is shipped from the factory after the specifications are confirmed. Agilent can guarantee that the modules will function and that the module performance is designed to meet its specifications. However, if you have any trouble, contact your nearest Agilent Technologies service center.

If you require that the modules be guaranteed to their specifications (for ISO compliance, etc.), then you must perform a calibration on the instrument (modules and mainframe together). This requirement arises because the mainframes contain both a Ground Unit and an A/D converter, which define the specification. Therefore, to guarantee the specifications it is necessary to take compensation data for the combination of mainframe and modules.

For calibration, you need the dedicated equipment and accessories. Prepare the all required items or contact your nearest Agilent Technologies service center.

Removal

1. Turn off the mainframe, then wait at least 10 seconds. See Figure 3-2.
2. Disconnect the power cable from rear panel.
3. Disconnect all cables from the modules.
4. Loosen the screws on the plate.
5. Remove the plate.
6. Set the module extractor to the knob position. The extractors are located at the left and right on the module front panel
7. Hold the module extractor and gently pull out the module.

Installation

1. Align the module with the left and right slot guide rails in the mainframe.
2. Hold the extractor at the left and right on the module front panel.
3. Gently push the module into the slot until you feel it contacts the connector of the slot.
4. Set the module extractor to the lock position.
5. Replace the plate by using the screws.
6. Check the operation of the mainframe with the modules as follows.
 - a. Connect the power cable and turn on the mainframe.
 - b. After the self-test is completed, check the front panel LCD. No mark must be set to the Error indicator.

Figure 3-2

Plug-in Module Removal and Installation

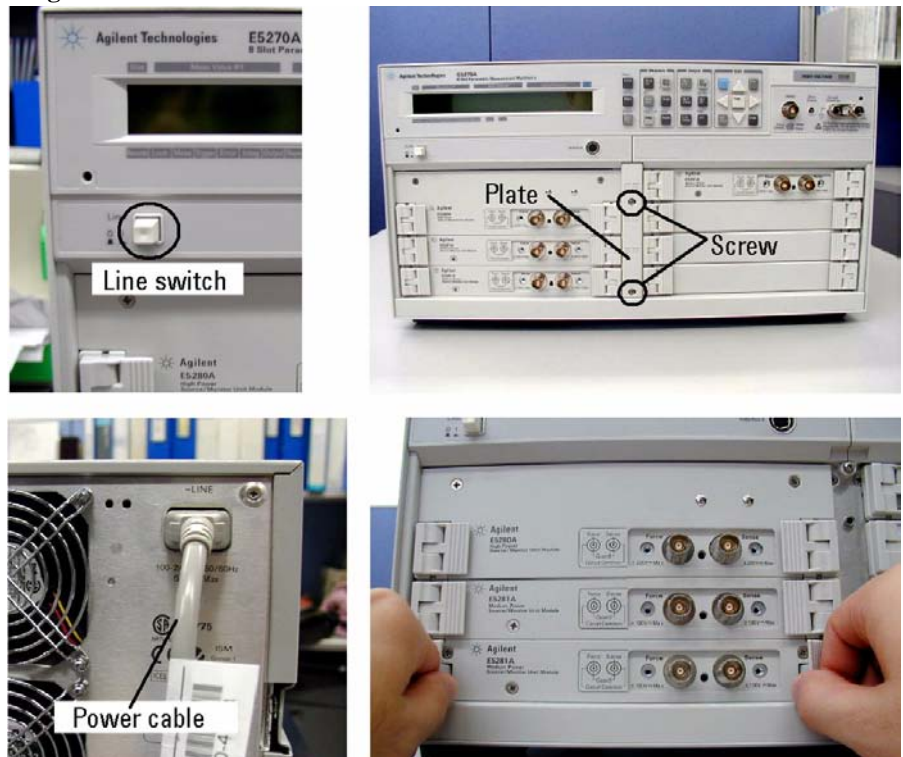

Installing Accessories

This section describes how to install the Agilent E5260/E5270 and accessories. Additional information regarding airflow can be found in the “Ventilation Requirements” on page 3-4.

This section describes how to:

- “To Connect 16442B Test Fixture”
- “To Connect Connector Plate”
- “To Connect ASU”
- “To Connect GNDU Adapter”

WARNING

There are potentially hazardous voltages of up to ± 100 V (MPSMU) or ± 200 V (HPSMU) at the Force, Sense, and Guard terminals. To prevent electrical shock, do *not* expose these lines.

WARNING

To prevent electrical shock during use, install and connect an interlock circuit that opens the Interlock terminal when the shielding box access door is opened. Use the Agilent 16493J Interlock cable to connect the interlock circuit.

CAUTION

The GNDU can sink current of up to 4 A (E5260A/E5270B) or 2.2 A (E5262A/E5263A). Use Agilent 16493L GNDU cable to connect the GNDU to a test fixture or a connector plate.

Do *not* use normal triaxial cable (16494A) because the maximum current rating of the cable is 1 A.

CAUTION

Never connect the Guard terminal to any output, including circuit common, chassis ground, or any other guard terminal. Doing so will damage the SMU.

To Connect 16442B Test Fixture

See this section if you use the Agilent 16442B Test Fixture. This section describes how to set up the 16442B and how to connect the E5260/E5270 to the 16442B.

To Set up 16442B

You can stabilize the 16442B as shown in the figure below.

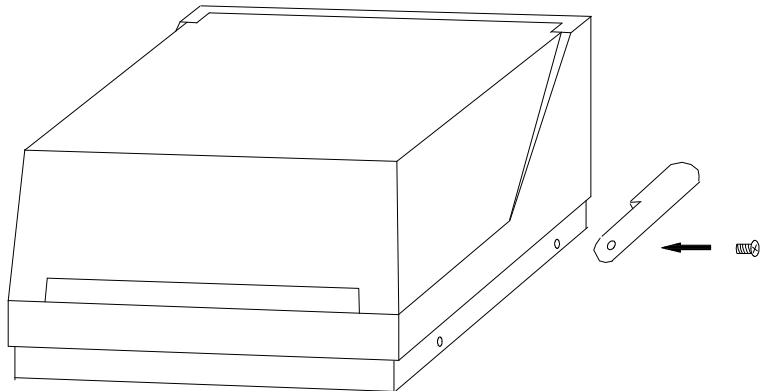

1. Put a stabilizer on both sides of the test fixture.
2. Attach each stabilizer to the unit with a flathead screw.

To Connect 16442B

Use the following cables to connect from the E5260/E5270 connectors to the 16442B's relative connectors.

Cables	16442B Terminals	E5260/E5270 Terminals	
Agilent 16493J Interlock Cable, 3 m or 1.5 m	Intlk	Interlock	
Agilent 16493L GNDU Cable, 3 m or 1.5 m	GNDU	GNDU	
For Kelvin connection: Agilent 16493K Kelvin Triaxial Cable, 3 m or 1.5 m Up to 3 SMUs can be connected to the 16442B by the Kelvin connection.	SMU1	SMU	Force
	SMU2		Sense
	SMU3	SMU	Force
	SMU4		Sense
	SMU5	SMU	Force
	SMU6		Sense
For non-Kelvin connection: Agilent 16494A Triaxial Cable, 3 m or 1.5 m Up to 6 SMUs can be connected to the 16442B by the non-Kelvin connection.	SMU1	SMU	Force
	SMU2	SMU	Force
	SMU3	SMU	Force
	SMU4	SMU	Force
	SMU5	SMU	Force
	SMU6	SMU	Force

NOTE

Making non-Kelvin connection

The Force terminals can be used to force and measure DC voltage or current. If you want to simplify the cable connections, open the Sense terminals and connect the Force terminals only to the test fixture by using the triaxial cables.

If you make the kelvin connection, use both Force and Sense terminals. Connecting the Force and Sense lines together at the terminal of the device under test minimizes the measurement error caused by the residual resistance of the connection cables. The kelvin connection is effective for the low resistance measurement and the high current measurement.

To Connect Connector Plate

The connector plates available are listed in Table 3-1. For connector plate installation information, refer to *Agilent 16495 Installation Guide*.

Table 3-1 Connector Plates

Model	Option Item	Connectors
16495F	16495F-001	Triax. (f-f) ×12, GNDU (f-f) ×1, Interlock (f) ×1
	16495F-002	Triax. (f) ×12, GNDU (f) ×1, Interlock (f) ×1
16495G	16495G-001	Triax. (f-f) ×24, GNDU (f-f) ×1, Interlock (f) ×1
	16495G-002	Triax. (f) ×24, GNDU (f) ×1, Interlock (f) ×1
16495H	16495H-001	Triax. (f-f) ×6, Coax. (f-f) ×6, GNDU (f-f) ×1, Interlock (f) ×1
	16495H-002	Triax. (f) ×6, Coax. (f) ×6, GNDU (f) ×1, Interlock (f) ×1
16495J	16495J-001	Triax. (f-f) ×8, Coax. (f-f) ×4, GNDU (f-f) ×1, Interlock (f) ×1
	16495J-002	Triax. (f) ×8, Coax. (f) ×4, GNDU (f) ×1, Interlock (f) ×1
16495K	16495K-001	Connector plate for ASU

Option 001 provides the through connectors except for the Interlock connector that provides the soldering patterns at the back side.

For the option 002, the back of each connector is designed for soldering.

NOTE

Making non-Kelvin connection

The Force terminals can be used to force and measure DC voltage or current. If you want to simplify the cable connections, open the Sense terminals and connect the Force terminals only to the connector plate by using the triaxial cables.

If you make the kelvin connection, use both Force and Sense terminals. Connecting the Force and Sense lines together at the terminal of the device under test minimizes the measurement error caused by the residual resistance of the connection cables.

The kelvin connection is effective for the low resistance measurement and the high current measurement.

Installation
Installing Accessories

Use the following cables to connect from the E5260/E5270 connectors to the connector plate's relative connectors.

Cables	Connector Plate	E5260/E5270 Terminals	
Agilent 16493J Interlock Cable, 3 m or 1.5 m	Intlk	Interlock	
Agilent 16493L GNDU Cable, 3 m or 1.5 m	GNDU	GNDU	
<p>For Kelvin connection:</p> <p>Agilent 16493K Kelvin Triaxial Cable, 3 m or 1.5 m</p> <p>Up to 4 SMUs can be connected to the 16495J by the Kelvin connection.</p> <p>Up to 6 SMUs can be connected to the 16495F by the Kelvin connection.</p> <p>Up to 3 SMUs can be connected to the 16495H by the Kelvin connection. Connectors 7 and 8 are not triaxial.</p>	1	SMU	Force
	2		Sense
	3	SMU	Force
	4		Sense
	5	SMU	Force
	6		Sense
	7	SMU	Force
	8		Sense
<p>For non-Kelvin connection:</p> <p>Agilent 16494A Triaxial Cable, 3 m or 1.5 m</p> <p>Up to 8 SMUs can be connected to the 16495J by the non-Kelvin connection.</p> <p>Up to 6 SMUs can be connected to the 16495H by the non-Kelvin connection. Connectors 7 and 8 are not triaxial.</p>	1	SMU	Force
	2	SMU	Force
	3	SMU	Force
	4	SMU	Force
	5	SMU	Force
	6	SMU	Force
	7	SMU	Force
	8	SMU	Force

NOTE

Use the Agilent 16494B Kelvin Triaxial Cable to connect to the Agilent E5250A Low Leakage Switch Mainframe or the connector plate for the Agilent 4142B Modular DC Source/Monitor by the kelvin connection.



Connecting the interlock terminal

The Agilent E5260/E5270 provides the Interlock connector to prevent you from receiving an electrical shock from high voltage (more than ± 42 V). If the Interlock connector is open, the Agilent E5260/E5270 *cannot* force high voltage more than ± 42 V.

When using the 16442B test fixture, connect the Interlock connectors together using the 16493J interlock cable.

If you use the 16495F/G/H/J connector plate, your own connector plate, or your own test fixture, make an interlock circuit as shown in “To Make an Interlock Circuit” on page 3-23. Then connect the Agilent E5260/E5270 Interlock connector to the external interlock connector by using the 16493J interlock cable.

To Connect ASU

The Agilent E5288A Atto Sense and Switch Unit (ASU) will add the 1 pA range to the high resolution SMU (HRSMU) when it is connected between the HRSMU and the device under test (DUT). And the ASU provides the input selection function when instruments are connected to the SMU input and the AUX input.

NOTE

For the installation of the ASU and the connection to the DUT interface (probe card, manipulators, and so on), contact your favorite prober vender. The prober vender will have the solutions. Dimensions of the ASU are 132 mm (W) × 88.5 mm (H) × 50 mm (D) excluding the connectors.

Figure 3-3 Image of ASU Installation

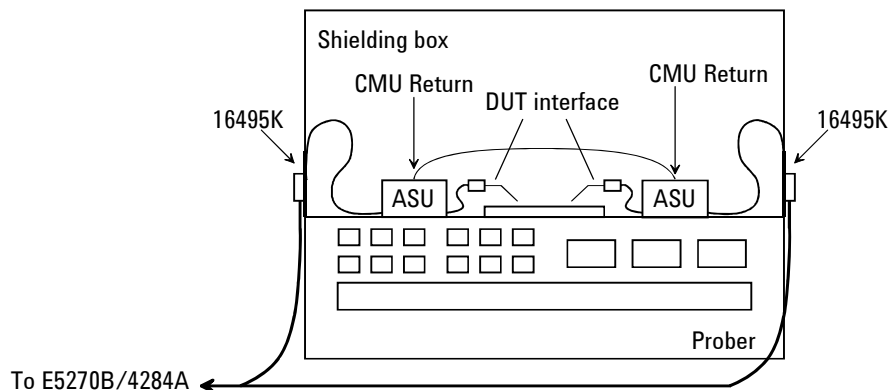

Required parts

- Agilent 16495K Connector plate
- Agilent 16493M ASU cable
- Agilent 16048D/E test leads
- Agilent N1254A-108 Magnet stand
- BNC cable, coaxial cable, manipulator, wire and so on

To install 16495K

Fix the 16495K plate to the shielding box or something that will cover the DUT interface. See *Agilent 16495 Installation Guide*. The 16495K is the plate that has the mechanism to block the light from the cable hole used to pass the cables in the shielding box.

To install ASU

1. Fix the ASU in the shielding box. The ASU must be fixed to the best position for accessing its connectors. The Agilent N1254A-108 Magnetic Stand will be useful for fixing the ASU.
2. Pass the 16493M (D-sub cable, triaxial cable), 16048D/E test leads, BNC cable and so on through the cable hole of the 16495K. They will be connected between the ASU and the instruments
3. Connect the D-sub cable to the ASU D-sub connector.
Connect the triaxial cable to the ASU Force terminal.
Connect the cable to the ASU CMU-cur/AUX In terminal. See Figure 3-4.
 - For the Agilent 4284A LCR meter, connect the Agilent 16048D/E test leads.
 - For the instrument other than the 4284A, connect the BNC cable to the CMU-cur/AUX In terminal. And open the CMU-pot terminal or cover it by using the BNC open cap.
4. Adjust the cable length in the shielding box, and catch in the cables by using the cover of the 16495K.
5. Connect the cable extended from the DUT interface to the ASU output terminal.
For the non Kelvin connection, open the Sense terminal or cover it by using the triaxial open cap.

To connect E5270B

1. Turn the Agilent E5270B off.
2. Connect the D-sub cable from the ASU to the HRSMU D-sub connector.
3. Connect the triaxial cable from the ASU to the HRSMU Force terminal.

NOTE

The specifications of the ASU are guaranteed while it is connected to the exclusive HRSMU. Confirm the serial number of the HRSMU and the ASU, and connect them properly. See “To Display Module Serial Number” on page 5-13.

To connect other instrument to AUX

1. Turn the instrument off.
2. Connect the BNC cable from the ASU CMU-cur/AUX In terminal to the instrument. Prepare an adapter if the instrument’s input/output connector is not BNC.

Figure 3-4

To Connect ASU

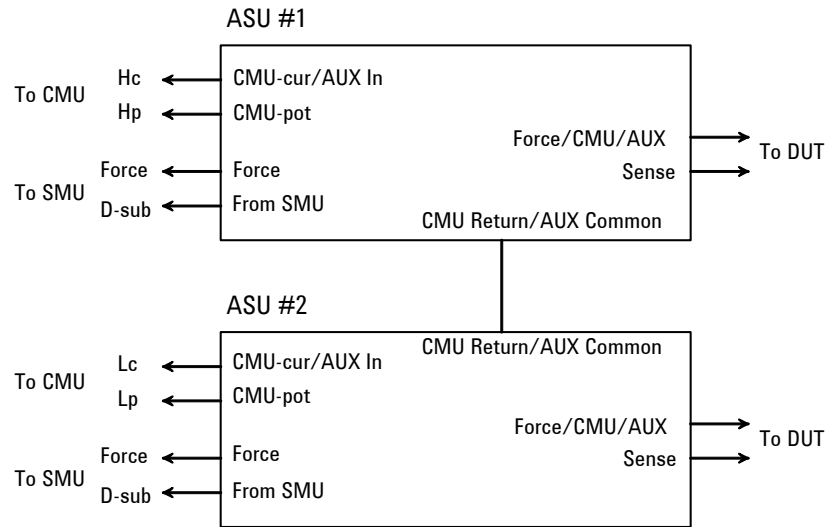
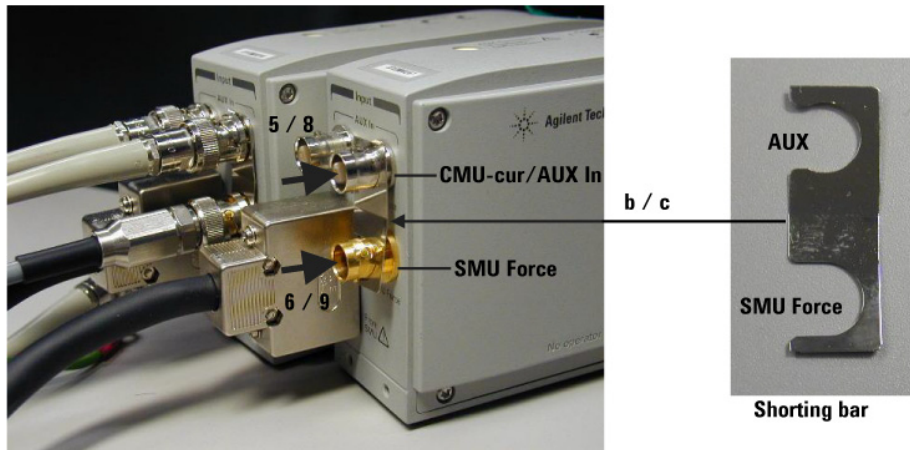

Figure 3-5

To Set Shorting Bar



**To connect 4284A
to AUX**

Perform the following procedure to connect the Agilent 4284A. See Figure 3-4 and Figure 3-5.

Prepare a shorting bar furnished with the ASU. The shorting bar is effective for reducing the offset capacitance caused by connecting a measurement terminal to the chuck of a wafer prober.

1. Turn the instrument off.
2. Prepare two ASUs (#1 and #2) and two shorting bar. And perform the following procedure for each ASU.
 - a. Disconnect the triaxial cable from the ASU if it is connected to the ASU Force terminal.
 - b. Face the concave side of the shorting bar to front.
 - c. Slide the shorting bar from the right side of the connectors.
3. Connect the 16048D/E test leads to the 4284A.
4. Connect the high potential (Hp) cable of the test leads to the ASU #1 CMU-pot terminal.
5. Connect the high current (Hc) cable to the ASU #1 CMU-cur/AUX In terminal. The shorting bar is fixed to the ASU #1 by the step 5 and 6.
6. Connect the triaxial cable from the HRSMU #1 Force terminal to the ASU #1 Force terminal.
7. Connect the low potential (Lp) cable to the ASU #2 CMU-pot terminal.
8. Connect the low current (Lc) cable to the ASU #2 CMU-cur/AUX In terminal. The shorting bar is fixed to the ASU #2 by the step 8 and 9.
9. Connect the triaxial cable from the HRSMU #2 Force terminal to the ASU #2 Force terminal.
10. Prepare the connection wire (both pin terminals) furnished with the ASU and connect it between the CMU Return terminals of the ASU #1 and ASU #2 together.

NOTE

About ASU output cables

To perform capacitance measurements accurately, the cable length between DUT and the ASU output must be as short as possible.

To Connect GNDU Adapter

The ground unit (GNDU) output is the single triaxial connector. The Agilent N1254A-100 GNDU to Kelvin Adapter enables to change it to the dual triaxial connector. Connect the adapter to the GNDU connector on the front panel, then connect a Kelvin triaxial cable to extend the GNDU terminal. Maximum current is restricted when the Kelvin triaxial cable is used. See Table 3-2.

Figure 3-6

Agilent N1254A-100 GNDU to Kelvin Adapter

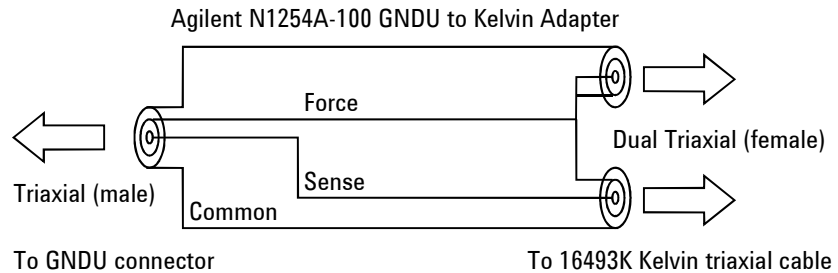

Table 3-2

Kelvin Triaxial Cable and Maximum Current

Model No. or Option Item	Description	Maximum Current
16493K-001	1.5 m Kelvin Triaxial Cable	3.0 A
16493K-002	3 m Kelvin Triaxial Cable	2.6 A

Mounting Connectors

Previous sections described how to install the available accessories, and *Agilent 16495 Installation Guide* provides the information on how to install connector plates on the shielding box. However, you may choose to mount connectors directly on your own connector plate or test fixture.

To do this, you will need to make connector holes and mount the connectors yourself. This section contains information on connector hole dimensions.

To mount connectors:

1. Select the appropriate parts for your application. See Table 3-3.
2. Make the holes and mount the connectors. See Table 3-4.

For Kelvin connections, use the Agilent 16493K Kelvin triaxial cable. The Kelvin triaxial cable requires a Kelvin triaxial connector, which has two connector holes and three screw holes.

3. Build the interlock circuit shown in “To Make an Interlock Circuit” on page 3-23.
4. Attach cables from the connectors to the DUT (device under test). Refer to “To Connect the GNDU Output” on page 3-26, “To Connect the SMU Output” on page 3-27.

Table 3-3

Recommended Parts

Usage	Agilent Part No.	Description
Making an interlock circuit	1252-1419C	Interlock Connector (6 pin, female)
	3101-0302 or 3101-3241	Switch
	1450-0641	LED ($V_F \cong 2.1 \text{ V} @ I_F = 10 \text{ mA}$)
	8150-5680	Wire
Connecting GNDU to DUT	1250-2457	Triaxial Connector (female)
	8121-1189 or 8150-2639	Coaxial Cable or Wire
Connecting SMU to DUT	1250-2457	Triaxial Connector (female)
	8121-1191	Low Noise Coaxial Cable

To Make an Interlock Circuit

The interlock circuit is designed to prevent electrical shock when a user touches the measurement terminals.

CAUTION

You must install an interlock circuit on a shielding box to prevent hazardous voltages when the door of the shielding box is open.

Figure 3-7 shows the pin assignments of the interlock connector that should be mounted on a connector plate or test fixture.

Figure 3-7

Interlock Connector Pin Assignments

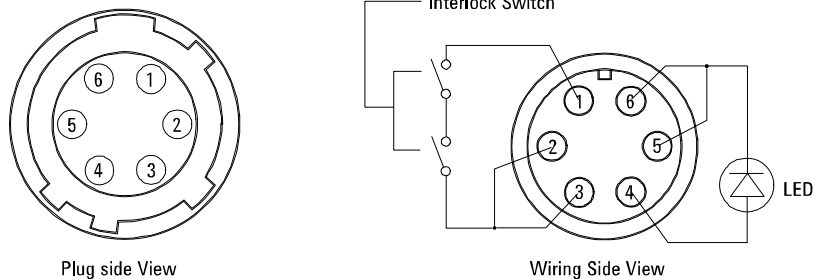

WARNING

Potentially hazardous voltages may be present at the Force, Guard, and Sense terminals when the interlock terminals are shorted.

Installing the interlock circuit

Install the interlock circuit as follows:

1. Mount two mechanical switches on your shielding box, so that the switches close when the door of the shielding box is closed, and open when the door is opened. For the dimensions of the switch, see Figure 3-9 and Figure 3-10 below.
2. Mount an LED on your shielding box. For the dimensions of the LED, see Figure 3-8.
3. Use wire to connect the two switches in series between pin number 1 and 2 (or 3) of the interlock connector. See Figure 3-7.
4. Use wire to connect the LED between pin number 4 and 5 (or 6) of the interlock connector. See Figure 3-7.

If the Agilent E5260/E5270 Interlock connector is connected to the interlock circuit, the Agilent E5260/E5270 SMU *cannot* force more than ± 42 V when the door is open. When the door is closed, it can force more than ± 42 V.

When more than ± 42 V is forced from an SMU, the LED lights to indicate *high voltage output*.

Figure 3-8

Dimensions of the LED (Agilent part number 1450-0641)

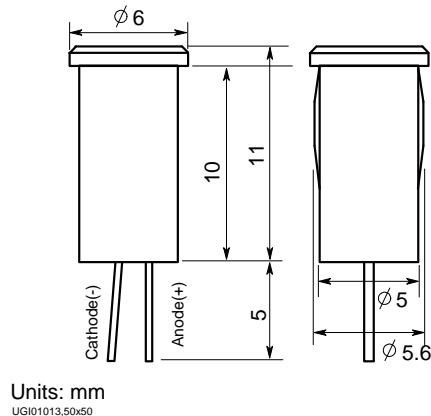

To Connect the GNDU Output

The following figures show connection examples for the GNDU output.

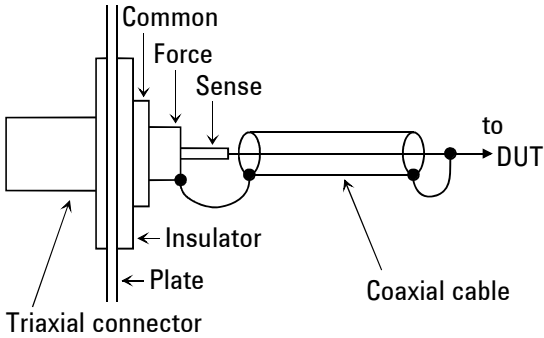
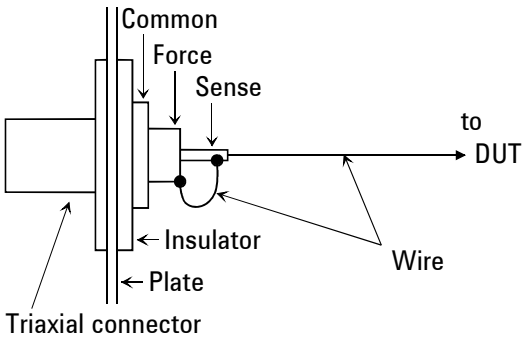
Kelvin connections	non-Kelvin connections
<p>Use a low-noise coaxial cable (Agilent part number 8121-1189) from the connector to the prober, socket, or DUT as shown.</p> <p>To cancel the effects of cable resistance, connect the Sense line and Force line as close as possible to the terminal of the DUT.</p>	<p>Short the Sense and Force on the connector as shown below. Measurement data will include the residual resistance of the connection wire.</p> <p>Use AWG 22 single-strand insulated wire (Agilent part number 8150-2639) from the connector plate to the prober, socket, or DUT.</p> <p>For a quick connection where measurement accuracy is not critical, connect only Force to the DUT, without shorting the Sense and Force. With this connection, the measurement data will include residual resistance from the connection cable between the GNDU and the connector plate.</p>
	

CAUTION

Use Agilent 16493L GNDU cable to connect the GNDU to your connector plate or test fixture. Do *not* use the triaxial cable. The GNDU is rated for up to 4 A (E5260A/E5270B) or 2.2 A (E5262A/E5263A), while the maximum current rating of the triaxial cable is 1 A.

To Connect the SMU Output

The following figures show connection examples for the SMU output.

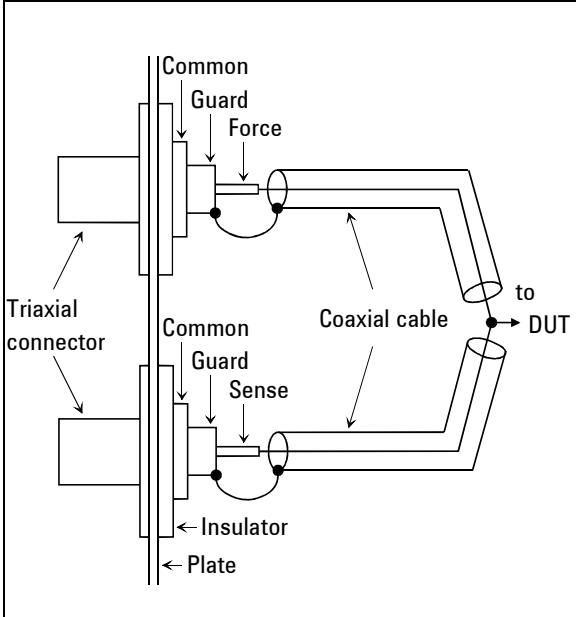
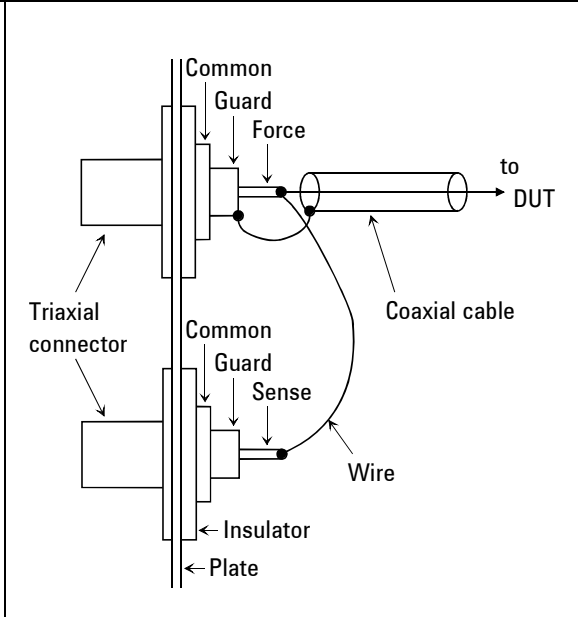
Kelvin connections	non-Kelvin connections
<p>Use low-noise coaxial cable (Agilent part number 8121-1191) from the connector to the prober, socket, or DUT as shown.</p> <p>To cancel the effects of cable resistance, connect the Sense line and Force line as close as possible to the DUT terminal.</p> <p>To prevent oscillations, do not use cables longer than 1.5 m.</p> <p>To make accurate measurements when applying high currents, extend the guard as far as possible from the front panel connector to the DUT. Physically stabilize the cables with tape.</p>	<p>The following figure is for the connection using Kelvin triaxial cable. For the connection using triaxial cable, connect the cable to the Force terminal only. Measurement data will include residual resistance from the connection cable.</p> <p>Use low-noise coaxial cable (Agilent part number 8121-1191).</p> <p>To make accurate measurements when applying high currents, extend the guard as far as possible from the front panel connector to the DUT.</p>
 <p>The diagram shows a Kelvin connection setup. On the left, a triaxial connector is connected to a front panel. The front panel has terminals for Common, Guard, Force, Sense, Insulator, and Plate. Two coaxial cables are connected to the Force and Sense terminals. The Force cable is connected to the DUT. The Sense cable is connected to the DUT as close as possible to the Force terminal. The Guard terminal is connected to the Common terminal.</p>	 <p>The diagram shows a non-Kelvin connection setup. On the left, a triaxial connector is connected to a front panel. The front panel has terminals for Common, Guard, Force, Sense, Insulator, and Plate. A single coaxial cable is connected to the Force terminal and extends to the DUT. A wire is connected to the Sense terminal and also extends to the DUT. The Guard terminal is connected to the Common terminal.</p>

Installation

Mounting Connectors

NOTE

Low-Noise Coaxial Cable

For the extended measurement paths over the connector plate, use low-noise coaxial cable (Agilent part number 8121-1191). This cable can maximize the guard effects and minimize the impression of the external noise.

Following figure shows the cutting example of this cable. Key point is the isolation between the conductive layer and the center conductor. So, cut and trim the end of the cable as shown in this figure by using a cutter and so on.

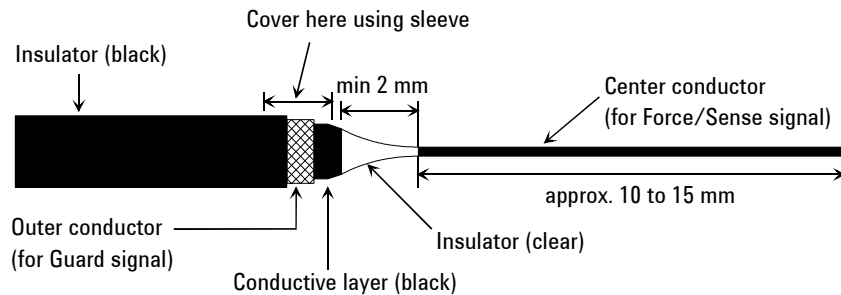

CAUTION

Never connect the Guard terminal to any output, including circuit common, chassis ground, or any other guard terminal. Doing so will damage the SMU.

WARNING

Potentially hazardous voltages, up to ± 100 V (MPSMU) or ± 200 V (HPSMU), are present at the Force, Sense, and Guard terminals.

To prevent electrical shock, do not expose these lines.

Before turning the Agilent E5260/E5270 on, connect the Interlock terminal to an interlock circuit.

Before you touch any connections to these terminals, turn the Agilent E5260/E5270 off, disconnect the power cable, and discharge any capacitors.

Connecting Measurement Devices

This section describes how to connect device under test (DUT) to the 16442B test fixture, and how to connect cables to the connector plate.

If you use a wafer prober, see wafer prober manuals.

Note that you must set the module output off when connecting or disconnecting DUTs. If not, the DUTs may be damaged.

To set the module output off, press **OutCh** and **On/Off** keys and confirm that the Output status indicator shows the off status for the all channels.

This section has the following descriptions:

- “Using Test Fixture”
- “Using Connector Plate”

NOTE

Kelvin connection and non-Kelvin connection

To make the Kelvin connection, use both Force and Sense terminals. Connecting the Force and Sense lines together at the terminal of the DUT (device under test) minimizes the measurement error caused by the residual resistance of the connection cables. The Kelvin connection is effective for the low resistance measurement and the high current measurement.

If you want to simplify the cable connections, open the Sense terminals and use the Force terminals only. This is the non-Kelvin connection. The Force terminals can be used to force and measure dc voltage or current.

Using Test Fixture

1. Press the **OutCh** and **On/Off** keys, and confirm that the Output status indicator shows the off status for the all channels.
2. Select a proper socket module for your DUT, then set the socket module on the test fixture.
3. Mount your DUT on the socket module.
4. Connect between the socket module and the test fixture by using the proper test leads.
5. Close the lid of the test fixture.

To force more than ± 42 V, close the lid of the test fixture. Otherwise, the interlock function will stop the Agilent E5260/E5270 output.

To connect between the socket module and the test fixture, you can use test leads that have the following terminals:

- Miniature banana-to-miniature banana
- Miniature banana-to-pin plug
- Miniature banana-to-miniature clip

CAUTION

Do not connect or disconnect your DUT while the Agilent E5260/E5270 is forcing voltage or current. Otherwise, your DUT may be damaged.

CAUTION

Do not touch the terminals of the test leads. Oil, perspiration, and dirt prevent good electrical contact, deteriorate insulation, and degrade measurement accuracy.

Connections for High Current Measurements

When you force or measure a large current, you may want to use a **Kelvin (4-wire) connection** to eliminate the residual resistance effects of test leads and contacts. For example, you can use the following connections as Kelvin connections on the test fixture.

Examples: Kelvin Connection

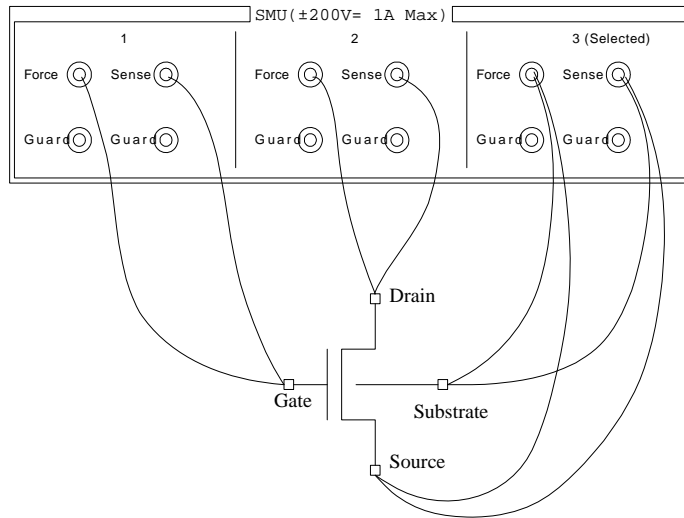

To cancel the effects of the residual resistance, test leads must be connected as close as possible to the DUT.

Using Connector Plate

This section provides the information useful for connecting cables and probing needles to a connector plate.

- “To Reduce Leakage Current”
- “To Measure Low Resistance”

To Reduce Leakage Current

To reduce the leakage current caused by connection cables, the guard technique is effective. Connect the probing needles to the terminals of the connector plate by using coaxial cables as shown below:

1. At end of cable, connect coaxial center conductor to force terminal of connector plate, and connect coaxial outer conductor to guard terminal of connector plate.
2. At another end, connect coaxial center conductor to tail of the probing needle. Never connect the outer conductor at this cable end.

Extend the outer conductor as close as possible to the probing needle.

Example

The following example connection can be used to reduce the leakage current. Extend the outer conductor as close as possible to the probing needle. This also reduces the induced noise.

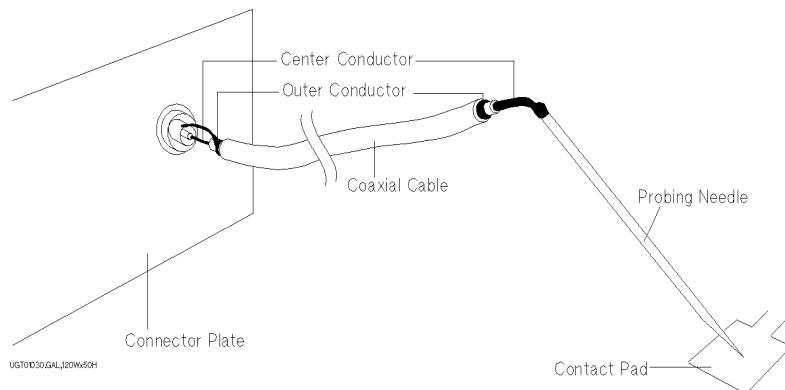

WARNING

Do not touch the guard terminal with bare hands because you may be shocked by high voltage. The potential of the guard terminal is equal to the output voltage.

CAUTION

Never connect the guard terminal to any other output, including circuit common, frame ground, or the terminals of any other unit. Doing so may damage the unit.

Guarding

Guarding reduces the leakage current between the measurement points and instrument. This is important when you measure low current.

The following figure shows the theory of guarding. The buffer amplifier ($\times 1$) keeps the potential of the guard conductor at the same potential as the force conductor, so current does not flow between the force and guard conductors. Therefore, the current measured by SMU is same as current at measurement point because no current is leaked.

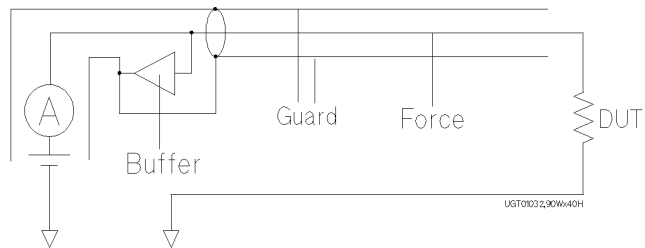

To Measure Low Resistance

When you measure a low resistance, high current flows through the DUT. This high current increases the measurement error caused by the residual resistance of cables. To cancel the effect of this resistance, you can use *Kelvin connections* (4-wire), which means the force and sense lines are extended separately to the DUT.

Connect the probing needles to the terminals of the connector plate by using test leads or coaxial cables. Following instruction uses the coaxial cables:

1. At end of cable, connect coaxial center conductor to force terminal of connector plate, and connect coaxial outer conductor to guard terminal of connector plate.
2. At another end, connect coaxial center conductor to tail of the probing needle. Never connect the outer conductor at this cable end.

Extend the outer conductor as close as possible to the probing needle.

3. Repeat 1 and 2 for the sense terminal of connector plate.
4. Contact the probing needles from force and sense terminals as close as possible to the DUT.

Example

The following example connection can be used to measure low resistance. The sense line is extended to the probing pad, and contacts the force line through the pad, so the voltage drop due to the residual resistance caused by cables and test leads is canceled.

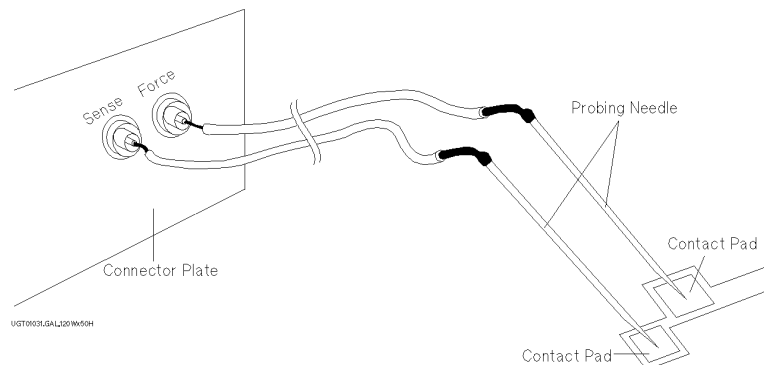

This example uses test leads. To reduce the leakage current, use coaxial cables.

Kelvin Connection

Kelvin connections give good measurement results when you force high-current. The following figure shows the equivalent circuits for Kelvin and non-Kelvin connections.

- For the non-Kelvin connection, the voltmeter measures the voltage drop of resistances r_{F1} , R_{DUT} , and r_{F2} .
- For the Kelvin connection, the voltmeter measures the voltage drop of resistance R_{DUT} only. The impedance of the voltmeter is very high, so the voltage drop of resistances r_{S1} and r_{S2} can be ignored.

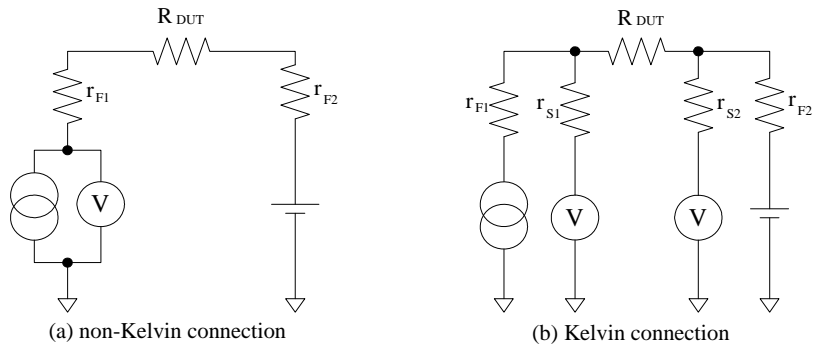

The Kelvin connection is effective even when forcing voltage. The voltage drop due to the residual resistance of the force line wiring is fed back to the voltage source via a comparator in the sense line. The input impedance of comparator is high, and current flow into the sense line is very low. So output error is not significant if the sense line wiring has a residual resistance of 10 Ω or less. Therefore, the specified voltage appears at the sense point (point where sense line contacts force line)

Maintenance

Maintenance should be performed periodically to keep the Agilent E5260/E5270 in good condition.

Calibration

Calibration and adjustments must be performed periodically so that the instruments satisfy the specifications, and keep a good condition. It is recommended to perform the calibration once a year at least. For the calibration and adjustments, contact your nearest Agilent Technologies Service Center. Trained service personnel will perform the calibration and adjustments.

NOTE

When shipping the Agilent E5260/E5270 to the service center

When you ship the Agilent E5260/E5270 to the Agilent Technologies service center, do not remove the source monitor unit (SMU) from the mainframe, and ship the mainframe with all SMU modules.

When you ship the Agilent E5270B used with the atto sense/switch unit (ASU), disconnect the connection cables between the ASU and the high resolution source monitor unit (HRSMU), and ship the ASU, connection cables, and the mainframe. Then do not remove any module from the mainframe. The ASU can be used with the dedicated HRSMU. So check the serial number, and ship the proper ASU.

Cleaning

Before performing cleaning, turn off the instrument, and disconnect power cable from the rear panel. Use a dry cloth to clean the external case parts.

To prevent electrical shock, do not perform cleaning when the instrument is turned on, and do not use a wet cloth.

Self-test and Diagnostics

Agilent E5260/E5270 provides the following functions to check the operation. Perform the following functions as necessary.

- Self-test
Refer to “To Perform Self-test” on page 5-7.
- Self-calibration
Refer to “To Perform Self-Calibration” on page 5-8.
- Diagnostics
Refer to “To Perform Diagnostics” on page 5-9.

Installation
Maintenance

Front Panel Reference

This chapter provides the reference information of the Agilent E5260/E5270 front panel keys and display.

- “Display and Front Panel Keys”
- “Front Panel Key Details”
- “Setup Menus”

Display and Front Panel Keys

The Agilent E5260/E5270 provides an LCD and 24 front panel keys for front panel operation. This section explains the user interface.

- “Display Images”
- “Front Panel Key Locations”
- “Channel Status Area”
- “Setup Data Area”
- “Measurement Data Area”
- “Status Data Area”

Display Images

The LCD displays the measurement data, the setup information, and the status information as shown in the following example.

Stat	Meas Value #1	Meas Value #2	Setting Parameter	Shift
C	1.23456mA	1.23456mV	OUT: 1.234mV	
	A ▼ ▼	1 1	CPL: 1.234mA	
Render	Lock	Meas	Trigger	Error
Integ	Output	Repeat	M-ch	S-ch

This example notifies you that channel 1 applies 1.234 mV with 1.234 mA compliance setting and executes repeat measurement with the integration time auto mode. It also shows the measurement results, 1.23456 mA and 1.23456 mV, and notifies you that channel 1 reaches its compliance setting.

Front Panel Reference

Display and Front Panel Keys

The display area consists of the following sub areas that have the meanings described below.

- In normal operation, or when changing source output or compliance value:

A	Meas Data 1	Meas Data 2	Setup Data 1	B
Status Data			Setup Data 2	

- When changing measurement setup or source setup:

A	Meas Data 1	Meas Data 2	Setup Data 1	B
Change Setup				

- A** Channel status T, C, V, X, or blank. See “Channel Status Area” on page 4-6.
- B** Shift key status on (triangle mark) or off (blank). The **Shift** key toggles the mark. While the mark appears, you can use the sub key function instead of the original key function.
- Setup Data 1, 2** Source output setting, source compliance setting, measurement range setting, or error code. See “Setup Data Area” on page 4-7.
- Meas Data 1, 2** Measured value, calculated power value, or calculated resistance value. See “Measurement Data Area” on page 4-8.
- Status Data** Status information, measurement channel number, and source channel number. See “Status Data Area” on page 4-9.
- Change Setup** Displays a setup menu or a setup message when you change any setup. For details, see “Front Panel Key Details” on page 4-10 and “Setup Menus” on page 4-18.

Front Panel Key Locations

The following 24 front panel keys are available.

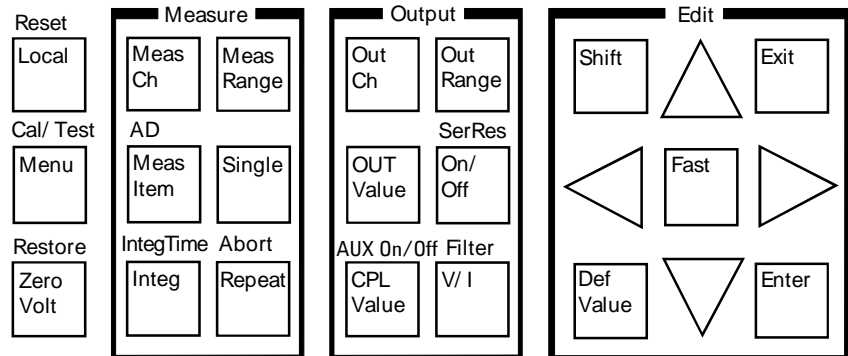

Local key sets the Agilent E5260/E5270 to the local condition.

Menu key displays a setup menu. See “Setup Menu” on page 4-18.

ZeroVolt key stores the present source settings and changes the output to 0 V.

Measure key group is used to set up the measurement condition and start measurement. See “Measure key group” on page 4-11.

Output key group is used to set up the source condition and apply the source output. See “Output key group” on page 4-14.

Edit key group is used to move the cursor in the display, make the setup effective, return to the previous menu or display, and so on.

Shift key enables use of the sub key function. The sub key label has been printed on the front panel above the key. The label color is blue.

DefValue key applies the default value to the setup item specified by the cursor in the display area.

Fast key is used with the arrow key. Pressing the **Fast** key and an arrow key speeds up changing the setting value.

Exit key returns to the previous menu or display without making the setup effective.

Enter key makes the setup effective, and returns to the previous menu or display.

For details of the front panel keys, see “Front Panel Key Details” on page 4-10.

Channel Status Area

This area displays one of the following status codes that indicate the status of the measurement channels. If some status errors are detected, the most serious status code is displayed in this area.

Table 4-1

Channel Status Code

Display	Description	Level of importance
	Blank means no status error occurred.	
T	Another channel reached its compliance setting.	1 (low)
C	This channel reached its compliance setting.	2
V	Measurement data is over the measurement range.	3
X	One or more channels are oscillating.	4 (high)

Setup Data Area

The Setup Data 1 and Setup Data 2 areas display the source output setting, the source compliance setting, the measurement range setting, or the error code. The display item can be selected by the MON_ITEM menu, displayed by pressing the **Menu** key. The item for the Setup Data 1 area can be specified by the ITEM1 parameter, and the item for the Setup Data 2 area can be specified by the ITEM2 parameter. Table 4-2 shows the display format in the setup data area.

Table 4-2 Setup Data Area

Display Example	Description
OUT: -123.4mV	Source output setting. Four-digit numeric value with arithmetic point, and unit. Pulse base value will be displayed for the pulse source. ^a
CPL: -12.34mA	Source compliance setting. Four-digit numeric value with arithmetic point, and unit.
VMR: 2V	Range value used for the voltage measurement. Available range values depend on the module.
IMR: 10uA	Range value used for the current measurement. Available range values depend on the module. where uA means μ A.
ERR: No Err	Error code.

- a. A pulse source is available for the pulsed spot measurement, pulsed sweep measurement, staircase sweep with pulsed bias measurement, or quasi-pulsed spot measurement when the E5260/E5270 is in the remote condition.

NOTE

If you press the **OUT Value** or **CPL Value** key, this area displays the following items:

- Setup Data 1: OUT (source output setting)
- Setup Data 2: CPL (source compliance setting)

Then, press the **Exit** or **Enter** key to return to the previous items.

Measurement Data Area

The Meas Data 1 and Meas Data 2 areas can display the following items. The display item can be selected by pressing the **MeasItem** key. Table 4-3 shows the display format in the measurement data area.

	For Voltage Output Channel		For Current Output Channel	
	Meas Data 1	Meas Data 2	Meas Data 1	Meas Data 2
Case 1	Current		Voltage	
Case 2	Current	Voltage	Voltage	Current
Case 3	Power		Power	
Case 4	Resistance		Resistance	

where power and resistance are given by the following formulas.

$$\text{Power} = \text{Measured Voltage} \times \text{Measured Current}$$

$$\text{Resistance} = \text{Measured Voltage} / \text{Measured Current}$$

Table 4-3

Measurement Data Area

Display	Description
Example: -123.456pA	Engineering display format. ^a Six-digit numeric value with arithmetic point, and unit.
Example: -1.234E-10A	Scientific display format. ^a Four-digit numeric value with arithmetic point, exponential part (E, +/- sign, and one- or two-digit numeric value), and unit.
OFF	Output off status. Source output is disabled. To perform measurement, set the output ON.
-----	No data to display.
Overflow	Overflow. Use higher measurement range.

a. The display format, engineering or scientific, can be selected by the DSPL_FRMT menu displayed by pressing the **Menu** key.

Status Data Area

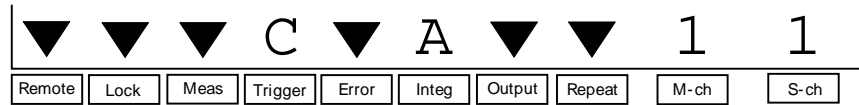

The Status data area shows the following statuses.

Label	Description
Remote	Remote status indicator. The triangle mark appears when the Agilent E5260/E5270 is in the remote condition.
Lock	Key status indicator. The triangle mark appears when the front panel keys are locked by an external computer.
Meas	Measurement status indicator. The triangle mark appears when the measurement has been performed. Then you cannot change the channel setup. If the time to get one measurement data item is too short, the triangle mark is not displayed.
Trigger	Trigger wait mode. C: GPIB command, S: Step source start, or M: Step measurement start. The trigger function is available for the GPIB remote condition. See <i>Programming Guide</i> .
Error	Error status indicator. The triangle mark appears when any error has occurred.
Integ	A/D converter operation mode. A: Auto, M: Manual, or P: PLC. For details, see “Measure key group” on page 4-11.
Output	Output status indicator. The triangle mark appears while the source output is being applied by the channel specified by S-ch. For the Agilent E5270B, if ASU (Atto Sense and Switch Unit) connects to the AUX side, not SMU side, the reversed triangle mark appears.
Repeat	Repeat measurement status indicator. The triangle mark appears when the repeat measurement mode is selected.
M-ch	Measurement channel number effective for the data displayed in the Meas Data area. 1 or 2 for 2-ch, one of 1 to 8 for 8-ch mainframe.
S-ch	Source channel number effective for the data displayed in the Setup Data area. 1 or 2 for 2-ch, one of 1 to 8 for 8-ch mainframe.

NOTE

In the remote mode and the default setting, the statuses of Output, Repeat, M-ch, and S-ch are not displayed. To display all information, set the RMT_DSPL function ON. Refer to “RMT_DSPL” on page 4-24.

Front Panel Key Details

The front panel keys are used to change the instrument settings, apply DC bias, measure DC current or voltage, and so on.

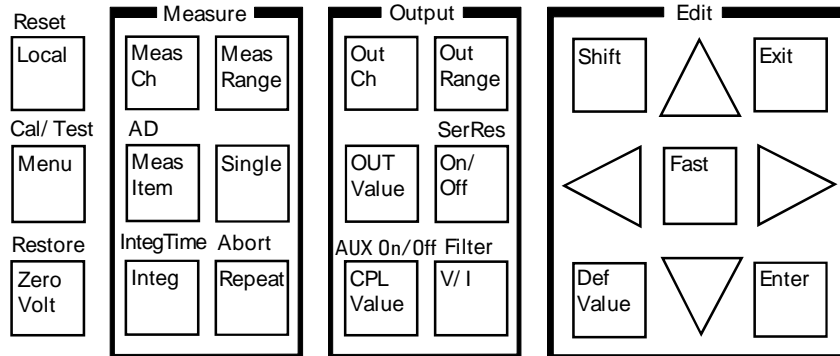

When the Change Setup area is displayed, only the Edit keys except for the **Shift** key are available.

Local

Sets the Agilent E5260/E5270 to the local condition.

Reset (Shift+Local)

Displays the following message. Press the arrow key to set **YES**, and then press the **Enter** key to reset the instrument.

Reset: NO

Menu

Displays the setup menu in the Change Setup area. See “Setup Menu” on page 4-18.

Cal/Test (Shift+Menu)

Displays the calibration and test menu in the Change Setup area. See “Calibration and Test Menu” on page 4-25.

ZeroVolt

Displays the following message. Press the arrow key to set **YES**, and then press the **Enter** key to store the present source settings and change the source output to 0 V. If the message shows `No enabled channel`, press the **Exit** key.

0 V Output: NO

Restore (Shift+ZeroVolt)

Displays the following message. Press the arrow key to set **YES**, and then press the **Enter** key to restore the source settings stored by the **ZeroVolt** key operation. If the message shows `No stored data`, press the **Exit** key.

Restore: NO

Measure key group

The Measure key group is used to set up the measurement condition and start measurement.

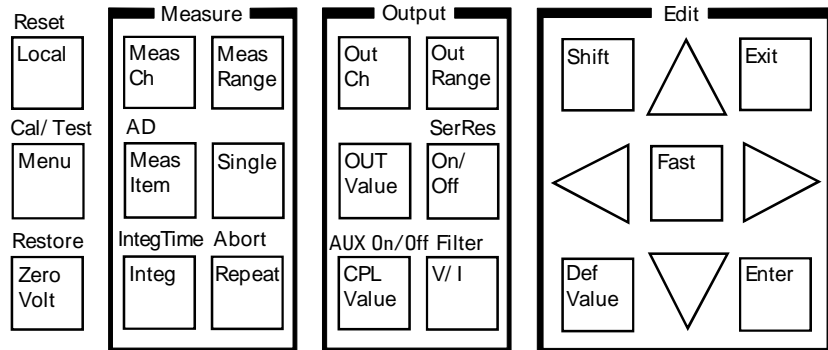

MeasCh

Selects the measurement channel effective for the data displayed in the Meas Data area. Press the **MeasCh** key repeatedly until the desired channel number appears in the M-ch status area.

MeasItem

Selects the measurement item, DC voltage or current, both DC voltage and current, resistance, or power.

Press the **MeasCh** key to specify the measurement channel, and press the **MeasItem** key repeatedly until the desired measurement item appears in the Meas Data area. The measurement item can be specified for each measurement channel.

AD (Shift+MeasItem)

The Agilent E5260 series does not have this shift key. Available only for the Agilent E5270B. This shift key operation displays the following message.

[M-ch #] AD Type: H-SPEED or H-RESOLN

where # is 1 or 2 for the 2-ch mainframe, 1, 2, ... or 8 for the 8-ch mainframe.

Press the **MeasCh** key to specify the measurement channel, and press the arrow key to select the A/D converter type, H-SPEED or H-RESOLN. Then, press the **Enter** key to make the setup effective, or press the **Exit** key to cancel changing the setup.

H-SPEED Selects the high-speed A/D converter that is mounted on each module. For high speed measurement.

H-RESOLN Selects the high-resolution A/D converter that will be shared by multiple measurement modules. For reliable and accurate measurement.

The AD type can be specified for each measurement channel.

Integ	<p>Selects the A/D converter (ADC) operation mode (A: auto, M: manual, or P: PLC). Refer to Table 4-4. For the Agilent E5260, see the description of the H-SPEED.</p> <p>Press the MeasCh key to specify the measurement channel, and press the Integ key repeatedly until the desired mode appears in the Integ status area.</p> <p>The setup value is effective for the channels that use the same AD type.</p>
IntegTime (Shift+Integ)	<p>Displays one of the messages shown in Table 4-4. The message depends on the AD and Integ settings. For the Agilent E5260, see the description of the H-SPEED.</p> <p>This function sets the number of averaging samples of the high-speed A/D converter or the integration time of the high-resolution A/D converter. The value should be increased for reliable and accurate measurement, or decreased for high speed measurement. The meaning of the setting value depends on the settings of the A/D converter type and the ADC operation mode. Refer to Table 4-4.</p> <p>Press the MeasCh key to specify the measurement channel, and press the arrow key to set the integration time or the number of averaging samples. Then, press the Enter key to make the setup effective, or press the Exit key to cancel changing the setup.</p> <p>The setup value is effective for the channels that use the same settings of the AD type and the ADC operation mode.</p>
MeasRange	<p>Displays the measurement range setup menu in the Change Setup area. See “Measurement Range Setup Menu” on page 4-31.</p>
Single	<p>Selects the spot measurement mode and performs measurement using the channel specified by the channel number displayed in the M-ch status area. If measurement is in progress, stops measurement and performs spot measurement.</p> <p>Note that the channel can perform measurement when its Output status is ON.</p>
Repeat	<p>Selects the repeat measurement mode and performs measurement using the channel specified by the channel number displayed in the M-ch status area. If measurement is in progress, stops measurement and starts repeat measurement.</p> <p>Note that the channel can perform measurement when its Output status is ON.</p>
Abort (Shift+Repeat)	<p>Displays the following message. Press the arrow key to set YES, and then press the Enter key to stop measurement.</p>

Abort: NO

NOTE

Perform the Abort operation if the Agilent E5260/E5270 still continues the previous operation even though the condition was changed from remote to local.

Table 4-4 AD, Integ, and IntegTime Values

AD	Integ	IntegTime message ^a and description
H-SPEED	A	[M-ch #] H-SPEED A N*Ref[pt], N= Specify the <i>N</i> value shown in the following formula. Available values are 1 to 1023. Initial value is 1. <i>Number of averaging samples = N × reference</i> where <i>reference</i> is the number of averaging samples automatically set by the Agilent E5260/E5270 and cannot be changed.
	M	[M-ch #] H-SPEED M N[pt], N= Specify the number of averaging samples (<i>N</i>). Available values are 1 to 1023. Initial value is 1.
	P	[M-ch #] H-SPEED P N*128[pt], N= Specify the <i>N</i> value shown in the following formula. Available values are 1 to 100. Initial value is 1. <i>Number of averaging samples = N × 128</i> The Agilent E5260/E5270 gets 128 samples in a power line cycle. Hence, the <i>N</i> value is equal to the number of power line cycles.
H-RESOLN	A	[M-ch #] H-RESOLN A N*Ref[s], N= Specify the <i>N</i> value shown in the following formula. Available values are 1 to 127. Initial value is 6. <i>Integration time = N × reference</i> where <i>reference</i> is the integration time automatically set by the Agilent E5270B and cannot be changed.
	M	[M-ch #] H-RESOLN M N*80[us], N= Specify the <i>N</i> value shown in the following formula. Available values are 1 to 127. Initial value is 3. <i>Integration time = N × 80 μsec</i>
	P	[M-ch #] H-RESOLN P N/Freq[s], N= Specify the <i>N</i> value shown in the following formula. Available values are 1 to 100. Initial value is 1. <i>Integration time = N / power line frequency</i> The <i>N</i> value means the number of power line cycles.

a. # is 1 or 2 for the 2-ch mainframe, 1, 2, ... or 8 for the 8-ch mainframe.

Output key group

The Output key group is used to set up the source condition and apply the source output.

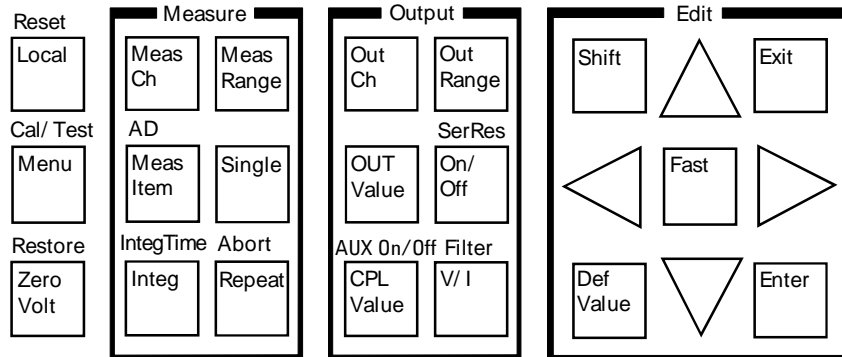

OutCh

Selects the source channel effective for the data displayed in the Setup Data area. Press the **OutCh** key repeatedly until the desired channel number appears in the S-ch status area.

OUT Value

Displays the source output setting (OUT) and the source compliance setting (CPL) in the Setup Data area. Then the cursor appears on the last digit of the integral part of the OUT value.

If the Output status indicator shows the source output ON status, the source channel applies the OUT value. Then, if you change the OUT value, the source channel changes the output value too.

To set the source output value, see “To Apply DC Current/Voltage” on page 5-16.

CPL Value

Displays the source output setting (OUT) and the source compliance setting (CPL) in the Setup Data area. Then the cursor appears on the last digit of the integral part of the CPL value.

The CPL value is current for voltage output, or voltage for current output.

To set the compliance value, see “To Apply DC Current/Voltage” on page 5-16.

**AUX On/Off
(Shift+CPL Value)**

The Agilent E5260 series does not have this function. This function is available for the Agilent E5270B installed with the high resolution SMU (HRSMU).

To use the ASU (Atto Sense and Switch Unit), connect the ASU to the HRSMU properly. The ASU adds the 1 pA range to the HRSMU. Connection must be performed before the Agilent E5270B is turned on.

If you use other instrument such as C meter, connect the instrument to the AUX input of the ASU. The ASU provides the input selection function.

This shift key operation is available when you are setting the HRSMU connected to the ASU, and switches the ASU input resource (HRSMU or the instrument connected to the AUX input) to be connected to the ASU output. When the E5270B is turned on, the SMU side is connected to the ASU output.

When the AUX side is connected to the ASU output, the HRSMU cannot be used. Then the Output indicator displays the reversed triangle mark.

The ASU is equipped with two LEDs that show which input is internally connected to the output.

OutRange

Displays the output range setup menu in the Change Setup area. See “Output Range Setup Menu” on page 4-32.

On/Off

Enables or disables the source output of the channel specified by the S-ch status indicator. Then the Output status indicator shows the source output ON or OFF status.

**SerRes
(Shift+On/Off)**

Displays the following message.

[S-ch #] Series Resistor: ON *or* OFF

where # is 1 or 2 for the 2-ch mainframe, 1, 2, ... or 8 for the 8-ch mainframe.

Press the **OutCh** key to specify the source channel, and press the arrow key to connect the series resistor (ON) to the channel or to disconnect it (OFF). Then press the **Enter** key to make the setup effective, or press the **Exit** key to cancel changing the setup.

A series resistor (1 M Ω) is mounted on each module. If you use a series resistor, the voltage you set is applied to the near side of the series resistor. Consequently, the voltage will be divided by the series resistor and the device under test.

The series resistor cannot be used for the measurements that use the high resolution SMU (HRSMU) connected to the Atto Sense and Switch Unit (ASU) or the measurements that use 1 A range of the high power SMU (HPSMU).

Front Panel Reference
Front Panel Key Details

V/I

Switches the source output mode, voltage output or current output.

Pressing the **V/I** key changes the output mode immediately. It also changes the measurement item as shown below:

Source Output Mode	OUT	CPL	Meas Data 1	Meas Data 2
V (voltage output)	Voltage	Current	Current	
			Current	Voltage
			Power	
			Resistance	
I (current output)	Current	Voltage	Voltage	
			Voltage	Current
			Power	
			Resistance	

**Filter
(Shift+V/I)**

Displays the following message.

[S-ch #] Filter: ON *or* OFF

where # is 1 or 2 for the 2-ch mainframe, 1, 2, ... or 8 for the 8-ch mainframe.

Press the **OutCh** key to specify the source channel, and press the arrow key to connect the filter (ON) to the channel or disconnect it (OFF). Then, press the **Enter** key to make the setup effective, or press the **Exit** key to cancel changing the setup.

A filter is mounted on each module. It assures clean source output with no spikes or overshooting.

Edit key group

The Edit key group is used to move the cursor in the display area, make the setup value effective, return to the previous menu or display, and so on.

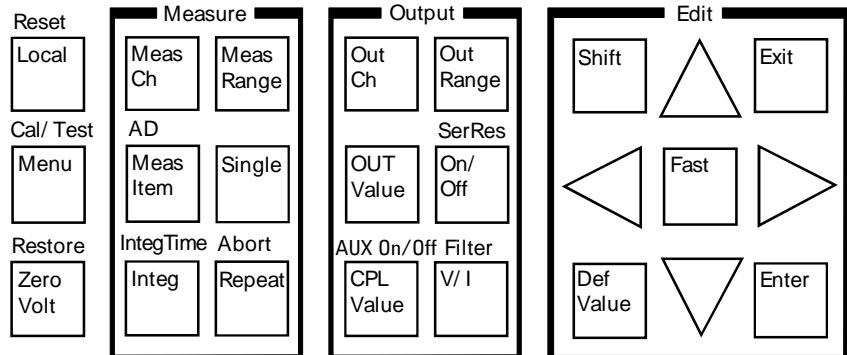

- Shift** Enables the sub key function. The sub key label has been printed on the front panel above the key. The label color is blue.
- DefValue** Applies the default value to the setup item specified by the cursor in the display area.
- Fast** Used with the arrow key. Pressing the **Fast** key and an arrow key speeds up changing the setting value.
- Exit** Returns the display to the previous menu or display without making the setup effective.
- Enter** Makes the setup effective, and returns the display to the previous menu or display.
- Up arrow** Increases the value of the digit specified by the cursor, displays another selection for a setup message, or moves the cursor to the left on a setup menu.
- Down arrow** Decreases the value of the digit specified by the cursor, displays another selection for a setup message, or moves the cursor to the right on a setup menu.
- Left arrow** Moves the cursor to the left or displays another selection for a setup message.
- Right arrow** Moves the cursor to the right or displays another selection for a setup message.

Setup Menus

This section explains the following setup menus displayed in the Change Setup area.

- “Setup Menu”
- “Calibration and Test Menu”
- “Measurement Range Setup Menu”
- “Output Range Setup Menu”

Setup Menu

Press the **Menu** key. The setup menu is displayed in the Change Setup area as shown in the following example. The setup menu is used to change the GPIB address, power line frequency, monitor items, data display format, and so on.

```
-123.456mA  -1.23456mV  OUT:-123.4mV  
CONFIG  MON_ITEM  DSPL_FRMT  >
```

```
-123.456mA  -1.23456mV  OUT:-123.4mV  
<WAIT_TIME  ERROR  RMT_DSPL  BEEP
```

Press the arrow key to move the cursor to the desired function name. Then, press the **Enter** key. The setup message or the sub menu will be displayed. To return to the previous menu, press the **Exit** key.

Function Tree

The setup menu provides the following functions.

- CONFIG
 - ADDRESS Sets the GPIB address.
 - LINEFREQ Sets the power line frequency.
 - REVISION Displays the firmware revision.
 - UNIT Displays the module information of each slot.
 - SERIAL Displays the serial number of each module.
- MON_ITEM
 - ITEM1 Selects the item displayed in the Setup Data 1 area.
 - ITEM2 Selects the item displayed in the Setup Data 2 area.
- DSPL_FRMT Selects the data display format, engineering or scientific.
- WAIT_TIME
 - SOURCE Sets the source wait time.
 - MEASURE Sets the measurement wait time.
- ERROR
 - DISPLAY Displays the error code and error message.
 - CLEAR Clears the error buffer.
- RMT_DSPL Selects on or off for the remote display mode.
- BEEP Selects on or off for the beeper.

Front Panel Reference

Setup Menus

CONFIG

Displays the sub menu that provides the following functions.

- ADDRESS

Displays the following message.

GPIB Address = Address

Press the arrow key to set the desired GPIB address. Then, press the **Enter** key to make the setup effective, or press the **Exit** key to cancel changing the setup.

- LINEFREQ

Displays the following message.

Line Frequency: 50Hz or 60Hz

Press the arrow key to select the power line frequency, 50 Hz or 60 Hz. Then press the **Enter** key to make the setup effective, or press the **Exit** key to cancel changing the setup.

- REVISION

Displays the following message.

FW: X.XX.XX AD: YY.YY

where *X.XX.XX* shows the firmware revision and *YY.YY* shows the revision number of the A/D converter (ADC) controller.

To return to the previous menu, press the **Exit** key.

- UNIT

Displays the following message.

Slot#: model, n, description

where # is 1 or 2 for the 2-ch mainframe, 1, 2, ... or 8 for the 8-ch mainframe, *model* is the model number, *n* is the revision number, and *description* is the module description.

To display another message, press the arrow key.

To return to the previous menu, press the **Exit** key.

- SERIAL

Displays the following message.

Slot#: xxxxxxxx

where # is 1 or 2 for the 2-ch mainframe, 1, 2, ... or 8 for the 8-ch mainframe, xxxxxxxx is the serial number of the module installed in the slot #.

If the atto sense and switch unit (ASU) is connected to the high resolution SMU (HRSMU), the following message will be displayed.

Slot#: xxxxxxxx yyyyyyyyyy

where xxxxxxxx is the serial number of the HRSMU, yyyyyyyyyy is the serial number of the ASU.

To display the serial number of the other module, press the arrow key.

To return to the previous menu, press the **Exit** key.

NOTE

If the incorrect ASU is connected to the HRSMU

The ASU can be used with only the HRSMU that was connected to it when the performance verification was performed. If the incorrect ASU is connected, “ERROR” will be displayed right of the serial number.

If “ERROR” is displayed, confirm the serial number of the ASU, turn the Agilent E5270B off, and connect the correct ASU.

Front Panel Reference

Setup Menus

MON_ITEM

Displays the sub menu that provides the following functions.

- ITEM1 Selects the item displayed in the Setup Data 1 area.
- ITEM2 Selects the item displayed in the Setup Data 2 area.

Move the cursor to the function you want to set, and press the **Enter** key. Then the following message will be displayed.

Monitor Item #: *Item*

where # is 1 for ITEM1 or 2 for ITEM2, and *Item* is one of the items listed below.

- OUT Source output setting of the output channel
- CPL Compliance setting of the output channel
- VMR Range value for the voltage measurement
- IMR Range value for the current measurement
- ERR Error code

Press the arrow key to select the item you want to display. Then, press the **Enter** key to make the setup effective, or press the **Exit** key to cancel changing the setup.

DSPL_FRMT

Displays the following message.

Display Format: ENGINEERING *or* SCIENTIFIC

Press the arrow key to select the data display format, ENGINEERING or SCIENTIFIC. Then, press the **Enter** key to make the setup effective, or press the **Exit** key to cancel changing the setup.

Display Format	Description
ENGINEERING	Six-digit numeric value with arithmetic point, and unit. Example: -123.456pA
SCIENTIFIC	Four-digit numeric value with arithmetic point, exponential part (E, +/- sign, and one- or two-digit numeric value), and unit. Example: -1.234E-10A

WAIT_TIME

Displays the sub menu that provides the following functions.

- SOURCE Sets the source wait time.
- MEASURE Sets the measurement wait time.

Move the cursor to the function you want to set, and press the **Enter** key. Then the following message will be displayed.

Wait Time =N*Ref [s]: N =

The source wait time is the time the source channel always waits after it starts the output and until it changes the output value. The measurement wait time is the time the measurement channel always waits after the source channel starts the output until the measurement channel starts the measurement. Refer to Figure 4-1. The wait time is given by the following formula:

$$\text{wait time} = N \times \text{reference}$$

where *reference* is the wait time the Agilent E5260/E5270 automatically sets according to the present settings; this wait time cannot be changed. Available *N* values are 0 to 10, 0.1 step. The initial value is 1. If you specify it too short, the measurement may start before device characteristics stable; if too long, time will be wasted.

Press the arrow key to set the *N* value. Then, press the **Enter** key to make the setup effective, or press the **Exit** key to cancel changing the setup. The settings are effective for all modules.

Figure 4-1

Source/Measurement Wait Time

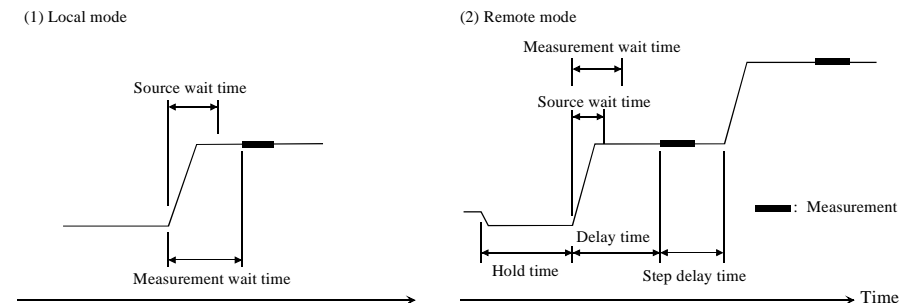

NOTE

In the local mode, you cannot set the hold time, delay time, and step delay time. They are automatically set to 0 s.

In the remote mode, if the delay time is longer than the wait time, the wait time can be ignored.

Front Panel Reference

Setup Menus

ERROR

Displays the sub menu that provides the following functions.

- DISPLAY

Displays the error code and error message, or `No Error`. A maximum of four error messages can be stored.

To return to the previous menu, press the **Exit** key.

- CLEAR

Displays the following message. Then, press the **Enter** key to clear the error buffer, or press the **Exit** key to cancel this operation.

`Clear Error Buffer: YES`

RMT_DSPL

Displays the following message.

`Display in Remote Mode: OFF or ON`

Press the arrow key to set the remote display mode ON or OFF. Then, press the **Enter** key to make the setup effective, or press the **Exit** key to cancel changing the setup.

This function changes the display items in the remote mode. If it is ON, the LCD displays the measured data, setup data, and all status information. If it is OFF (default setting), the LCD displays only a part of the status information. See “Display Images” on page 4-3 and “Status Data Area” on page 4-9.

Note that setting this function ON may adversely affect the performance such as the measurement speed.

BEEP

Displays the following message.

`BEEP: ON or OFF`

Press the arrow key to set the beeper ON or OFF. Then, press the **Enter** key to make the setup effective, or press the **Exit** key to cancel changing the setup.

Calibration and Test Menu

Press the **Shift** key and the **Menu** key. The calibration and test menu is displayed in the Change Setup area as shown below. The menu is used to set the auto-calibration, to execute the self-calibration, self-test, and diagnostics, and so on.

```

-123.456mA  -1.23456mV  OUT:-123.4mV
AUTO_CAL    ADC_ZERO   CAL    SELFTEST  >
```

```

-123.456mA  -1.23456mV  OUT:-123.4mV
<ADC_ZERO  CAL    SELFTEST  DIAG
```

Press the arrow key to move the cursor to the desired function name. Then, press the **Enter** key. The setup message or the sub menu will be displayed. To return to the previous menu, press the **Exit** key.

Function Tree

This menu provides the following functions.

- AUTO_CAL Sets auto-calibration on or off.
- ADC_ZERO Only for the E5270B. Sets the ADC zero function on or off.
- CAL
 - EXECUTE Executes self-calibration.
 - RESULT Displays the self-calibration result message.
- SELFTEST
 - EXECUTE Executes self-test.
 - RESULT Displays the self-test result message.
 - RECOVER Enables or disables use of the failed module.
- DIAG
 - EXECUTE Executes diagnostics.
 - RESULT Displays the diagnostics result message.

Front Panel Reference

Setup Menus

AUTO_CAL

Displays the following message.

Auto Calibration: ON *or* OFF

Press the arrow key to set auto-calibration ON or OFF. Then, press the **Enter** key to make the setup effective, or press the **Exit** key to cancel changing the setup.

The auto-calibration function automatically starts calibration for all modules every 30 minutes if the output switches of all modules are off for 30 minutes.

NOTE

To perform calibration correctly, the measurement terminals should be opened before starting calibration.

If auto-calibration is enabled, open the measurement terminals or disconnect the device under test from the measurement terminals after measurement.

ADC_ZERO

This function is not available for the Agilent E5260. Available only for the Agilent E5270B.

Displays the following message.

ADC Zero: ON *or* OFF

Press the arrow key to set the ADC zero function ON or OFF. Then, press the **Enter** key to make the setup effective, or press the **Exit** key to cancel changing the setup.

The ADC zero function is available for the high-resolution A/D converter (ADC) and not available for the high-speed ADC. This function measures the internal offset of the high-resolution ADC and compensates it automatically. The measurement data displayed on the LCD will be the data after compensation.

NOTE

This function is especially effective for low voltage measurements. Disable the function in cases where measurement speed is more important than measurement accuracy. This approximately halves integration time.

CAL

Displays the sub menu that provides the following functions.

- EXECUTE

Displays the following message.

Calibration: ALL

Press the arrow key to select the slot to calibrate. Then, press the **Enter** key to start self-calibration, or press the **Exit** key to return to the previous menu without performing self-calibration.

During self-calibration, the following message will be displayed.

Press [Exit] to abort

Then, press the **Exit** key to abort self-calibration, or wait until self-calibration is completed and the following message is displayed:

Calibration: Pass or Fail

Press the **Exit** key to return to the previous menu.

- RESULT

Displays the following message.

FRAME: Pass or Fail Error No.

Press the arrow key to display the result of another slot as shown below:

Slot#: Pass or Fail Error No.

where # is 1 or 2 for the 2-ch mainframe, 1, 2, ... or 8 for the 8-ch mainframe, and *Error No.* is the error number.

Press the **Exit** key to return to the previous menu.

NOTE

To execute CAL of Agilent E5270B installed with ASU

If you execute the CAL of the E5270B installed with the ASU (Atto Sense and Switch Unit), the E5270B executes the self-calibration and the 1 pA range offset measurement for the measurement channels connected to the ASUs. The offset data is temporarily memorized until the E5270B is turned off, and is used for the compensation of the data measured by the 1 pA range of the channels. The E5270B performs the data compensation automatically and returns the compensated data.

Since the E5270B is turned on, if you do not execute the CAL, the E5270B performs the data compensation by using the pre-stored offset data.

SELFTEST

Displays the sub menu that provides the following functions.

- EXECUTE

Displays the following message.

```
Selftest: ALL
```

Press the arrow key to select the test item. Then, press the **Enter** key to start the self-test, or press the **Exit** key to return to the previous menu without performing the self-test.

During the self-test, the following message will be displayed.

```
Press [Exit] to abort
```

Then, press the **Exit** key to abort the self-test. Or wait until the self-test is completed and the following message is displayed.

```
Selftest: Pass or Fail
```

Press the **Exit** key to return to the previous menu.

- RESULT

Displays the following message.

```
FRAME: Pass or Fail Error No.
```

Press the arrow key to display the result of another slot as shown below.

```
Slot#: Pass or Fail Error No.
```

where # is 1 or 2 for the 2-ch mainframe, 1, 2, ... or 8 for the 8-ch mainframe, and *Error No.* is the error number.

Press the **Exit** key to return to the previous menu.

- RECOVER

Displays the following message.

```
Recover Module: YES
```

Then, press the **Enter** key to use the failed modules, or press the **Exit** key to cancel this operation.

DIAG

Displays the sub menu that provides the following functions.

- EXECUTE

Displays the following message.

DIAG: *Item*

where *Item* is one of the following:

- GPIB GPIB diagnostics
- TRIGGER (BNC) Trigger In/Out diagnostics
- KEY Front panel key diagnostics
- HV-LED High voltage LED diagnostics
- DGFL-I/O Digital I/O diagnostics
- BEEPER Beeper diagnostics

Press the arrow key and the **Enter** key to select the diagnostics item, and refer to Table 4-5 to perform the diagnostics; or press the **Exit** key to return to the previous menu without performing diagnostics.

After the diagnostics, the following message is displayed:

DIAG: Pass or Fail or Aborted

Press the **Exit** key to return to the previous menu.

- RESULT

Displays the following message.

DIAG: *Item* Pass or Fail *Error No.* or Not performed yet

where *Item* is the diagnostics item and *Error No.* is the error number.

Press the arrow key to display the result of another item.

Press the **Exit** key to return to the previous menu.

Front Panel Reference
Setup Menus

Table 4-5 To Perform Diagnostics

Item	Description
GPIB	<p>For the next message, disconnect the GPIB cable from the GPIB connector. Then, press the Enter key to start diagnostics or the Exit key to return to the previous menu.</p> <p>Open GPIB, then press [Enter]. Press [Exit] to abort</p>
TRIGGER (BNC)	<p>For the next message, connect the BNC cable between the Ext Trig In and Out connectors. Then, press the Enter key to start diagnostics or the Exit key to return to the previous menu.</p> <p>Connect In to Out, then press [Enter]. Press [Exit] to abort</p>
KEY	<p>For the next message, press any front panel key.</p> <p>DIAG:KEY Press any key. OK: [Enter] twice or NG: [Exit] twice</p> <p>Then, the message will be changed as shown below:</p> <p>DIAG:KEY [label] OK: [Enter] twice or NG: [Exit] twice</p> <p>where <i>label</i> must be the name of the key you pressed.</p> <p>Press another key to continue the key diagnostics. Press the Enter key twice if all responses were good, or press the Exit key twice if any response was bad.</p>
HV-LED	<p>For the next message, press the Enter key if the High Voltage LED is blinking, or press the Exit key if the LED does not blink.</p> <p>DIAG:HV-LED Is the LED blinking? YES: [Enter] or NO: [Exit]</p>
DGTL-I/O	<p>For the next message, disconnect any cable from the digital I/O port. Then, press the Enter key to start the diagnostics, or press the Exit key to return to the previous menu.</p> <p>Open DGTL-I/O, then press [Enter]. Press [Exit] to abort</p>
BEEPER	<p>For the next message, press the Enter key to hear two types of beep sounds every second, or press the Exit key for no beep sounds.</p> <p>DIAG:BEEP Is beeper making 2 sounds? YES: [Enter] or NO: [Exit]</p>

Measurement Range Setup Menu

Press the **MeasRange** key to display the measurement range setup menu. The measurement range setup menu is displayed in the Change Setup area as shown below. The menu is used to set the voltage measurement ranging mode (V_RANGE) or the current measurement ranging mode (I_RANGE).

-123.456mA	-1.23456mV	OUT: -123.4mV
V_RANGE	I_RANGE	

Press the arrow key to move the cursor to the desired function name. Then, press the **Enter** key.

V_RANGE

Displays the following message.

[M-ch #] Meas Range: *Mode*

where # is 1 or 2 for the 2-ch mainframe, 1, 2, ... or 8 for the 8-ch mainframe, and *Mode* is the measurement ranging mode, AUTO, FIX xV, or LIM xV. Then, x indicates the range value. Available values depend on the module.

AUTO means auto ranging, FIX means fixed range, and LIM means limited auto ranging.

Press the arrow key to select the measurement ranging mode. Then, press the **Enter** key to make the setup effective, or press the **Exit** key to cancel changing the setup.

I_RANGE

Displays the following message.

[M-ch #] Meas Range: *Mode*

where # is 1 or 2 for the 2-ch mainframe, 1, 2, ... or 8 for the 8-ch mainframe, and *Mode* is the measurement ranging mode, AUTO, FIX xA, or LIM xA. Then, x indicates the range value. Available values depend on the module.

AUTO means auto ranging, FIX means fixed range, and LIM means limited auto ranging. Also, uA means μ A.

Press the arrow key to select the measurement ranging mode. Then, press the **Enter** key to make the setup effective, or press the **Exit** key to cancel changing the setup.

NOTE

Before using 1 pA range (only for E5270B)

The measurement channel connected to the ASU (Atto Sense and Switch Unit) supports the 1 pA range. To use the 1 pA range, set the 1 pA fixed range or the 1 pA limited auto ranging.

Output Range Setup Menu

Press the **OutRange** key to display the output range setup menu. The output range setup menu is displayed in the Change Setup area as shown below. The menu is used to set the voltage output ranging mode (V_RANGE) or the current output ranging mode (I_RANGE).

-123.456mA	-1.23456mV	OUT: -123.4mV
V_RANGE	I_RANGE	

Press the arrow key to move the cursor to the desired function name. Then, press the **Enter** key.

V_RANGE

Displays the following message.

[S-ch #] Output Range: *Mode*

where # is 1 or 2 for the 2-ch mainframe, 1, 2, ... or 8 for the 8-ch mainframe, and *Mode* is the output ranging mode, AUTO, FIX xV, or LIM xV. Then, x indicates the range value. Available values depend on the module.

AUTO means auto ranging, FIX means fixed range, and LIM means limited auto ranging.

Press the arrow key to select the output ranging mode. Then, press the **Enter** key to make the setup effective, or press the **Exit** key to cancel changing the setup.

I_RANGE

Displays the following message.

[S-ch #] Output Range: *Mode*

where # is 1 or 2 for the 2-ch mainframe, 1, 2, ... or 8 for the 8-ch mainframe, and *Mode* is the output ranging mode, AUTO, FIX xA, or LIM xA. Then, x indicates the range value. Available values depend on the module.

AUTO means auto ranging, FIX means fixed range, and LIM means limited auto ranging. Also, uA means μA .

Press the arrow key to select the output ranging mode. Then, press the **Enter** key to make the setup effective, or press the **Exit** key to cancel changing the setup.

5

Front Panel Operations

Front Panel Operations

This chapter explains how to use the Agilent E5260/E5270 in the local mode.

- “Available Functions”
- “Setting Up Agilent E5260/E5270”
- “Applying Source Output”
- “Making Measurement”

NOTE**Local Key**

Front panel operation is available when the Agilent E5260/E5270 is being set to local mode. Press the **Local** key to change the condition to local.

NOTE**Measurement Mode**

The Agilent E5260/E5270 supports the following measurement mode:

- High Speed Spot Measurement
- Spot Measurement
- Staircase Sweep Measurement
- Multi Channel Sweep Measurement
- 1 Channel Pulsed Spot Measurement
- Pulsed Sweep Measurement
- Staircase Sweep with Pulsed Bias Measurement
- Quasi-pulsed Spot Measurement
- Linear Search Measurement
- Binary Search Measurement

The measurement modes are available when the Agilent E5260/E5270 is being set to GPIB remote condition.

In local mode, the Agilent E5260/E5270 just applies DC voltage or current, and then measures DC voltage or current like the high speed spot measurement.

Available Functions

Table 5-1 lists the typical functions of the Agilent E5260/E5270.

Table 5-1 Typical Functions

Function	Operating Condition/Mode	
	Local	Remote
To use multiple source channels	Available	Available
To use multiple measurement channels	Not available	Available
To apply DC voltage or DC current	Available	Available
To apply DC voltage and measure DC current	Available	Available
To apply DC current and measure DC voltage	Available	Available
To apply DC voltage and measure DC voltage	Available	Available
To apply DC current and measure DC current	Available	Available
To display measurement, source, status data	Available	Available ^a
To calculate power and display the value	Available	Not available
To calculate resistance and display the value	Available	Not available
To set GPIB Address	Available	Not available
To set power line frequency	Available	Not available
To execute self-test	Available	Available
To execute self-calibration	Available	Available
To execute diagnostics	Available	Available
To use trigger input/output	Not available	Available
To use digital interface	Not available	Available

a. In the remote mode and the default setting, only a part of the status information is displayed. See “Status Data Area” on page 4-9.

Setting Up Agilent E5260/E5270

This section describes the following tasks of setting up the Agilent E5260/E5270.

- “To Set Line Frequency”
- “To Initialize Agilent E5260/E5270”
- “To Set Beeper”
- “To Apply Default Value”
- “To Select Monitor Items”
- “To Perform Self-test”
- “To Perform Self-Calibration”
- “To Perform Diagnostics”
- “To Set Auto-Calibration”
- “To Set ADC Zero Function”
- “To Read Error Message”
- “To Display Firmware Revision”
- “To Display Module Information”
- “To Display Module Serial Number”
- “To Set GPIB Address”
- “To Set Remote Display Mode”
- “To Return to Local Mode”

To Set Line Frequency

1. Press the **Menu** key.
2. Move the cursor to CONFIG, then press the **Enter** key.
3. Move the cursor to LINEFREQ, then press the **Enter** key.
4. Press the arrow keys to select the line frequency 50 Hz or 60 Hz.
5. Press the **Enter** key to make the setup effective, or press the **Exit** key to cancel changing the setup.
6. Press the **Exit** key twice to close the setup menu.

To Initialize Agilent E5260/E5270

1. Press the **Shift** key and the **Local** key.
2. Press the **Enter** key for the message `Reset : YES` to initialize the Agilent E5260/E5270, or press the **Exit** key to cancel initialization.

To Set Beeper

1. Press the **Menu** key.
2. Move the cursor to BEEP, then press the **Enter** key.
3. Press the arrow keys to select the beep ON or OFF.
4. Press the **Enter** key to make the setup effective, or press the **Exit** key to cancel changing the setup.
5. Press the **Exit** key to close the setup menu.

To Apply Default Value

Specify a setup item by using the cursor, then press the **DefValue** key to apply the default value to the setup item.

To Select Monitor Items

The following procedure selects the items displayed in the Setup Data area.

1. Press the **Menu** key.
2. Move the cursor to MON_ITEM, then press the **Enter** key.
3. Move the cursor to ITEM1 for the Setup Data 1 area, then press the **Enter** key.
4. Press the arrow keys to select the monitor item; OUT (source output value), CPL (compliance value), VMR (voltage measurement range setting), IMR (current measurement range setting), or ERR (error number).
5. Press the **Enter** key to make the setup effective, or press the **Exit** key to cancel changing the setup.
6. Move the cursor to ITEM2 for the Setup Data 2 area, then press the **Enter** key.
7. Perform 4 and 5 to set the item for ITEM2.
8. Press the **Exit** key twice to close the setup menu.

To Perform Self-test

1. Open the measurement terminals of the Agilent E5260/E5270.
2. Press the **Shift** key and the **Menu** key.
3. Move the cursor to SELFTEST, then press the **Enter** key.
4. Move the cursor to EXECUTE, then press the **Enter** key.
5. Press the arrow keys to select the self-test item; ALL, FRAME, or Slot n (n: 1 or 2 for 2-ch mainframe, 1 to 8 for 8-ch mainframe).
6. Press the **Enter** key to start the self-test, or press the **Exit** key to cancel it.
During the self-test, press the **Exit** key to abort the self-test.
7. Press the **Exit** key three times to close the setup menu.

To display test results

1. Press the **Shift** key and the **Menu** key.
2. Move the cursor to SELFTEST, then press the **Enter** key.
3. Move the cursor to RESULT, then press the **Enter** key.
4. Press the arrow keys to select the self-test item; FRAME or Slot n (n: 1 or 2 for 2-ch mainframe, 1 to 8 for 8-ch mainframe). The test result is displayed for each item.
5. Press the **Exit** key three times to close the setup menu.

To use modules that failed self-test

The following procedure enables you to use a module that failed self-test or self-calibration.

1. Press the **Shift** key and the **Menu** key.
2. Move the cursor to SELFTEST, then press the **Enter** key.
3. Move the cursor to RECOVER, then press the **Enter** key.
4. Press the arrow keys to select YES for the message Recover Module:.
5. Press the **Enter** key to perform this operation, or press the **Exit** key to cancel the operation.
6. Press the **Exit** key twice to close the setup menu.

To Perform Self-Calibration

1. Open the measurement terminals of the Agilent E5260/E5270.
2. Press the **Shift** key and the **Menu** key.
3. Move the cursor to CAL, then press the **Enter** key.
4. Move the cursor to EXECUTE, then press the **Enter** key.
5. Press the arrow keys to select the slot to calibrate; ALL or Slot n (n: 1 or 2 for 2-ch mainframe, 1 to 8 for 8-ch mainframe).
6. Press the **Enter** key to start calibration, or press the **Exit** key to cancel calibration.
During calibration, press the **Exit** key to abort it.
7. Press the **Exit** key three times to close the setup menu.

To display calibration results

1. Press the **Shift** key and the **Menu** key.
2. Move the cursor to CAL, then press the **Enter** key.
3. Move the cursor to RESULT, then press the **Enter** key.
4. Press the arrow keys to select the calibration item; FRAME or Slot n (n: 1 or 2 for 2-ch mainframe, 1 to 8 for 8-ch mainframe). The calibration result is displayed for each calibration item.
5. Press the **Exit** key three times to close the setup menu.

NOTE

To use a module that failed self-calibration, refer to “To use modules that failed self-test” on page 5-7. The procedure also applies to modules that failed self-calibration.

NOTE

If you execute the CAL of the E5270B installed with the ASU (Atto Sense and Switch Unit), the E5270B executes the self-calibration and the 1 pA range offset measurement for the measurement channels connected to the ASUs. The offset data is temporarily memorized until the E5270B is turned off, and is used for the compensation of the data measured by the 1 pA range of the channels. The E5270B performs the data compensation automatically and returns the compensated data.

Since the E5270B is turned on, if you do not execute the CAL, the E5270B performs the data compensation by using the pre-stored offset data.

To Perform Diagnostics

1. Press the **Shift** key and the **Menu** key.
2. Move the cursor to DIAG, then press the **Enter** key.
3. Move the cursor to EXECUTE, then press the **Enter** key.
4. Press the arrow keys to select the diagnostics item; GPIB, TRIGGER (BNC), KEY, HV-LED, DGTL-I/O, or BEEPER.

Before starting the diagnostics, perform the following:

- For GPIB, disconnect the GPIB cable.
 - For TRIGGER (BNC), connect a BNC cable between the Ext Trig In and Out connectors.
 - For DGTL-I/O, disconnect any cable from the digital I/O port.
 - For other diagnostics, no action is required.
5. Press the **Enter** key to start diagnostics, or press the **Exit** key to cancel diagnostics.

After starting the diagnostics, perform the following, or press the **Exit** key to abort the diagnostics.

- For KEY, press any front panel key; then the LCD displays the key name. Repeat this for all front panel keys.
If all responses were good, press the **Enter** key twice to stop.
If any response was bad, press the **Exit** key twice to stop.
 - For HV-LED, confirm that the LED blinks.
If the LED is blinking, press the **Enter** key to stop.
If the LED does not blink, press the **Exit** key to stop.
 - For BEEPER, confirm that the beeper makes two sounds every second.
If you hear it, press the **Enter** key to stop.
If you do not hear it, press the **Exit** key to stop.
 - For other diagnostics, no action is required.
6. Press the **Exit** key three times to close the setup menu.

To display diagnostics results

1. Press the **Shift** key and the **Menu** key.
2. Move the cursor to **DIAG**, then press the **Enter** key.
3. Move the cursor to **RESULT**, then press the **Enter** key.
4. Press the arrow keys to select the diagnostics item; **GPIB**, **TRIGGER (BNC)**, **KEY**, **HV-LED**, **DGTL-I/O**, or **BEEPER**. The diagnostics result is displayed for each diagnostics item.
5. Press the **Exit** key three times to close the setup menu.

To Set Auto-Calibration

1. Press the **Shift** key and the **Menu** key.
2. Move the cursor to AUTO_CAL, then press the **Enter** key.
3. Press the arrow keys to select the auto-calibration ON or OFF.
4. Press the **Enter** key to make the setup effective, or press the **Exit** key to cancel changing the setup.
5. Press the **Exit** key to close the setup menu.

NOTE

The auto-calibration function automatically starts calibration for all modules every 30 minutes if the output switches of all modules are off for 30 minutes.

If auto-calibration is enabled, open the measurement terminals or disconnect the device under test from the measurement terminals after measurement. To perform calibration properly, the measurement terminals should be opened before starting calibration.

To Set ADC Zero Function

This function is not available for the Agilent E5260. Available only for the Agilent E5270B.

1. Press the **Shift** key and the **Menu** key.
2. Move the cursor to ADC_ZERO, then press the **Enter** key.
3. Press the arrow keys to select the ADC zero function ON or OFF.
4. Press the **Enter** key to make the setup effective, or press the **Exit** key to cancel changing the setup.
5. Press the **Exit** key to close the setup menu.

NOTE

The ADC zero function is available for the high-resolution A/D converter (ADC) but not available for the high-speed ADC. This function measures the internal offset of the high-resolution ADC and compensates it automatically. The measurement data displayed on the LCD will be the data after compensation.

This function is especially effective for the low voltage measurement. Disable the function in cases where measurement speed is more important than measurement accuracy. This approximately halves the integration time.

To Read Error Message

1. Press the **Menu** key.
2. Move the cursor to ERROR, then press the **Enter** key.
3. Move the cursor to DISPLAY, then press the **Enter** key to display the message.
4. Press the arrow keys to read another error message. A maximum of four error messages can be stored.
5. Press the **Exit** key three times to close the setup menu.

To clear error buffer

1. Press the **Menu** key.
2. Move the cursor to ERROR, then press the **Enter** key.
3. Move the cursor to CLEAR, then press the **Enter** key.
4. Press the arrow key to select YES for the message Clear Error Buffer:.
5. Press the **Enter** key to clear the error buffer, or press the **Exit** key to cancel operation.
6. Press the **Exit** key twice to close the setup menu.

To Display Firmware Revision

1. Press the **Menu** key.
2. Move the cursor to CONFIG, then press the **Enter** key.
3. Move the cursor to REVISION, then press the **Enter** key. The firmware revision is displayed.
4. Press the **Exit** key three times to close the setup menu.

To Display Module Information

1. Press the **Menu** key.
2. Move the cursor to CONFIG, then press the **Enter** key.
3. Move the cursor to UNIT, then press the **Enter** key. The module information is displayed.
4. Press the arrow keys to display another module information item.
5. Press the **Exit** key three times to close the setup menu.

To Display Module Serial Number

1. Press the **Menu** key.
2. Move the cursor to CONFIG, then press the **Enter** key.
3. Move the cursor to SERIAL, then press the **Enter** key. The module serial number is displayed.

For the HRSMU (high resolution SMU) calibrated with the ASU (atto sense and switch unit), two serial numbers will be displayed. Then the HRSMU serial number is left and the ASU serial number is right. They always show the correct combination regardless of the ASU connection status. The HRSMU and the ASU are available only for the Agilent E5270B.

4. Press the arrow keys to display the serial number of the other module.
5. Press the **Exit** key three times to close the setup menu.

NOTE

Incorrect combination of HRSMU and ASU

The combination of HRSMU and ASU is important. The specifications of the ASU are guaranteed while it is connected to the exclusive HRSMU.

If the combination is incorrect, “ERROR” will be displayed right of the serial number. If “ERROR” is displayed, note the ASU serial number, turn the Agilent E5270B off, and connect the correct ASU.

To Set GPIB Address

1. Press the **Menu** key.
2. Move the cursor to CONFIG, then press the **Enter** key.
3. Move the cursor to ADDRESS, then press the **Enter** key.
4. Press the arrow keys to set the GPIB address.
5. Press the **Enter** key to make the setup effective, or press the **Exit** key to cancel changing the setup.
6. Press the **Exit** key twice to close the setup menu.

To Set Remote Display Mode

This instruction enables or disables the data display in the GPIB remote condition. See “RMT_DSPL” on page 4-24.

1. Press the **Menu** key.
2. Move the cursor to RMT_DSPL, then press the **Enter** key.
3. Press the arrow keys to set the remote display mode ON or OFF.
4. Press the **Enter** key to make the setup effective, or press the **Exit** key to cancel changing the setup.
5. Press the **Exit** key to close the setup menu.

To Return to Local Mode

Press the **Local** key. If the front panel keys are locked, send the KLC command from an external computer, then press the **Local** key.

Applying Source Output

This section describes the following tasks to apply DC current or DC voltage.

- “To Apply DC Current/Voltage”
- “To Set Output/Compliance Value”
- “To Set Source Output to Zero”
- “To Set Output Range”
- “To Use Series Resistor”
- “To Use Filter”
- “To Switch ASU Internal Connection”

To Apply DC Current/Voltage

The following procedure applies a DC bias using a source channel. To use multiple source channels, perform the procedure for all source channels.

1. Press the **OutCh** key repeatedly to specify the source channel.
The channel number must appear in the S-ch status area.
2. Confirm that the Output status indicator does not show the output enable status.
If the source output has been enabled, press the **On/Off** key. This disables the source output.
3. Press the **OutRange** key to select the output range.
See “To Set Output Range” on page 5-18.
4. Press the **Shift** key and the **On/Off** key if you are using a series resistor.
See “To Use Series Resistor” on page 5-19.
5. Press the **Shift** key and the **V/I** key if you are using a filter.
See “To Use Filter” on page 5-19.
6. If you are using the Agilent E5270B installed with the high resolution SMU (HRSMU) and if you want to change the internal connection of the ASU (Atto Sense and Switch Unit), see “To Switch ASU Internal Connection” on page 5-20.
7. Press the **OUT Value** key or the **CPL Value** key to set the source output value or the compliance value.
See “To Set Output/Compliance Value” on page 5-17.
8. Press the **On/Off** key to enable the source output.

NOTE

To change the source output value or the compliance value during source output, see “To Set Output/Compliance Value” on page 5-17.

To stop source output of the channel specified by the S-ch status, press the **On/Off** key.

To Set Output/Compliance Value

This instruction sets the source output or compliance value of the specified source channel.

1. Press the **OUT Value** key to set the output (OUT) value.
Or press the **CPL Value** key to set the compliance (CPL) value.
2. Press the **VI** key to select the output mode; V (voltage output) or I (current output).
3. Press the Left or Right arrow key to move the cursor to the digit whose value you want to change.
4. Press the Up or Down arrow key to change the value. Pressing the **Fast** key and the arrow key speeds up changing the value.
If the source output has been enabled (Output ON status), the new value will be applied to the output immediately.
5. Repeat 3 and 4 until the required OUT or CPL value is displayed on the LCD.
6. To set the value of another channel, press the **OutCh** key to select the channel, and perform 2 to 5.
7. Press the **Enter** key or the **Exit** key to end the output/compliance setup operation.

To multiply the value by 10 or 0.1

Move the cursor to the arithmetic point, and press the Up or Down arrow key. The Up arrow key will multiply the value by 10. The Down arrow key will multiply the value by 0.1.

Pressing the Up or Down arrow key changes the cursor condition from blink to inversion. This means the value is not effective yet. Then, press the **Enter** key to make the value effective, or press the **Exit** key to cancel multiplication.

This function is not effective for 0.0.

To set the digit over the highest digit

Move the cursor to the + or - sign, and press the Up or Down arrow key.

The Up/Down arrow key will add/subtract the value given by setting 1 instead of the sign and setting 0 to the other digits, to/from the present value. For example, if the present value is +0.100, the Up arrow key will set +10.10 (=0.100+10.000), and the Down arrow key will set -9.900 (=0.100-10.000).

To Set Source Output to Zero

This instruction stores the present source setup of all channels, and changes the output value to 0 V.

1. Press the **ZeroVolt** key.
2. Press the **Enter** key for the message `0 V Output : YES` to perform this operation, or press the **Exit** key to cancel operation.

To restore the source setup

This instruction restores the source setup stored by the **ZeroVolt** key function.

1. Press the **Shift** key and the **ZeroVolt** key.
2. Press the **Enter** key for the message `Restore : YES` to perform this operation, or press the **Exit** key to cancel operation.

To Set Output Range

This instruction sets the output range of the specified source channel.

1. Press the **OutRange** key.
2. For voltage output, move the cursor to `V_RANGE`, then press the **Enter** key.
For current output, move the cursor to `I_RANGE`, then press the **Enter** key.
3. Press the arrow keys to select the output range.
4. Press the **OutCh** key if you are setting the output range of the same output mode (voltage or current) channels, and perform 3.
5. Press the **Enter** key to make the setup effective, or press the **Exit** key to cancel changing the setup.
6. Press the **Exit** key to close the setup menu.

To Use Series Resistor

This instruction connects the series resistor to the specified channel internally.

1. Press the **Shift** key and the **On/Off** key.
2. Press the arrow keys, and select ON to connect the series resistor.
3. Press the **OutCh** key if you are setting the resistor for another channel, and perform 2.
4. Press the **Enter** key to make the setup effective, or press the **Exit** key to cancel changing the setup.

NOTE

A series resistor is mounted on each module. If you use a series resistor, the voltage you set is applied to the near side of the series resistor. Thus, the voltage will be divided by the series resistor and the device under test.

The series resistor cannot be used for the measurements that use the high resolution SMU (HRSMU) connected to the Atto Sense and Switch Unit (ASU) or the measurements that use 1 A range of the high power SMU (HPSMU).

To Use Filter

This procedure connects the filter to the specified channel internally.

1. Press the **Shift** key and the **V/I** key.
2. Press the arrow keys, and select ON to connect the filter.
3. Press the **OutCh** key if you are setting the filter for another channel, and perform 2.
4. Press the **Enter** key to make the setup effective, or press the **Exit** key to cancel changing the setup.

NOTE

A filter is mounted on each module. It assures clean source output with no spikes or overshooting.

To Switch ASU Internal Connection

The Agilent E5260 series does not have this function. This function is available for the Agilent E5270B installed with the high resolution SMU (HRSMU).

To use the ASU (Atto Sense and Switch Unit), connect the ASU to the HRSMU properly. The ASU adds the 1 pA range to the HRSMU. Connection must be done before the Agilent E5270B is turned on.

If you use other instrument such as C meter, connect the instrument to the AUX input of the ASU. The ASU provides the input selection function.

The following procedure switches the ASU input resource (HRSMU or the instrument connected to the AUX input) to be connected to the ASU output.

1. Press the **Shift** key and the **CPL Value** key.

The input resource will be switched. If you perform this key operation again, the connection will be switched to the previous resource. This key operation is available when you are setting the HRSMU connected to the ASU.

2. Press the **OutCh** key if you are setting the ASU for another channel, and perform 1.

NOTE

The ASU can be used with only the HRSMU that was connected to it when the performance verification was performed. To confirm if the ASU is the correct one, see “To Display Module Serial Number” on page 5-13.

When the E5270B is turned on, the SMU side is connected to the ASU output.

When the AUX side is connected to the ASU output, the HRSMU cannot be used. Then the Output indicator displays the reversed triangle mark.

Making Measurement

This section describes the following tasks to measure DC current or DC voltage.

- “To Measure DC Current/Voltage”
- “To Abort Measurement”
- “To Select Measurement Item”
- “To Select Measurement Range”
- “To Set A/D Converter”
- “To Set Wait Time”
- “To Set Data Display Format”

To Measure DC Current/Voltage

The following procedure performs DC current or voltage measurement using the specified measurement and source channel.

1. Press the **OutCh** key repeatedly to specify the source and measurement channel. The channel number must appear in the S-ch status area.
2. Confirm that the Output status indicator does not show the output enable status. If the source output has been enabled, press the **On/Off** key. This disables the source output.
3. Press the **MeasCh** key repeatedly to specify the source and measurement channel. The channel number displayed in the M-ch status area must be same as the channel number displayed in the S-ch status area.
4. Press the **MeasItem** key repeatedly to select the measurement item. See “To Select Measurement Item” on page 5-23.
5. Press the **MeasRange** key to set the measurement range. See “To Select Measurement Range” on page 5-24.
6. Press the **Integ** key repeatedly to select the A/D converter operation mode. See “To Set A/D Converter” on page 5-25.
7. Change the source output value if necessary. See “To Apply DC Current/Voltage” on page 5-16.
8. Press the **On/Off** key to enable the source output. The measurement channel Output status must be ON to perform the measurement.
9. Press the **Single** key to execute a spot measurement.
Or press the **Repeat** key to execute repeat measurements.

NOTE

To stop the repeat measurement, press the **Single** key.

To change the source output value or the compliance value during measurement, see “To Set Output/Compliance Value” on page 5-17.

To stop source output and measurement of the channel specified by the S-ch status, press the **On/Off** key.

To Abort Measurement

This instruction aborts measurement by all measurement channels.

1. Press the **Shift** key and the **Repeat** key.
2. Press the **Enter** key for the message `Abort: YES` to abort measurement, or press the **Exit** key to cancel the abort operation.

To Select Measurement Item

1. Press the **MeasCh** key repeatedly to specify the measurement channel. The channel number must appear in the M-ch status area.
2. Press the **MeasItem** key repeatedly to select the measurement item; voltage (V) or current (A), both voltage and current, resistance (Ω), or power (W).

To Select Measurement Range

This procedure sets the measurement range of the specified measurement channel.

1. Press the **MeasRange** key.
2. For voltage measurement, move the cursor to V_RANGE, then press **Enter**.
For current measurement, move the cursor to I_RANGE, then press **Enter**.
3. Press the arrow keys to select the measurement range.
4. If you set the measurement range of the same measurement mode (voltage or current) channels, press the **MeasCh** key to select the channel, and perform 3.
5. Press the **Enter** key to make the setup effective, or press the **Exit** key to cancel changing the setup.
6. Press the **Exit** key to close the setup menu.

NOTE

Before using 1 pA range (only for E5270B)

The measurement channel connected to the ASU (Atto Sense and Switch Unit) supports the 1 pA range. To use the 1 pA range, set the 1 pA fixed range or the 1 pA limited auto ranging.

The E5270B automatically performs the compensation of the data measured by the 1 pA range and returns the compensated data. You can use either the pre-stored offset data or the pre-measured offset data.

To measure the offset data, perform the self-calibration before starting the measurement for a DUT. This offset data is temporarily memorized until the E5270B is turned off.

To Set A/D Converter

The A/D converter (ADC) is set by the procedures below.

To select A/D converter

This function is not available for the Agilent E5260. Available only for the Agilent E5270B. This procedure selects the ADC type used by the specified measurement channel.

1. Press the **Shift** key and the **MeasItem** key.
2. Press the arrow keys to select the ADC type; H-SPEED (high-speed ADC) or H-RESOLN (high-resolution ADC, only for E5270B).
3. Press the **MeasCh** key if you are setting the ADC type of another channel, and perform 2.
4. Press the **Enter** key to make the setup effective, or press the **Exit** key to cancel changing the setup.

To select ADC operation mode

Press the **Integ** key repeatedly to select the ADC operation mode. There are three modes as below. The Integ status area shows the present setting. The setup is effective for all channels that use the same ADC type.

- A: auto mode
- M: manual mode
- P: PLC (power line cycle) mode

To set integration time

This procedure sets the number of averaging samples of the high-speed A/D converter or the integration time of the high-resolution A/D converter. The meaning of the setting value depends on the ADC type and ADC operation mode settings. The value should be increased for reliable and accurate measurement, or decreased for high speed measurement. Refer to Table 4-4 on page 4-13. The setup is effective for all channels that use the same ADC type.

1. Press the **Shift** key and the **Integ** key. The setup message shown in Table 4-4 is displayed. The message depends on the **Integ** and **AD** settings.
2. Press the arrow keys to set the *N* value for the message.
3. Press the **MeasCh** key if you are setting the value for measurement channels that use another ADC type, and perform 2.
4. Press the **Enter** key to make the setup effective, or press the **Exit** key to cancel changing the setup.

To Set Wait Time

This instruction sets the source wait time and the measurement wait time. The wait time settings are effective for all modules. Refer to “WAIT_TIME” on page 4-23.

1. Press the **Menu** key.
2. Move the cursor to WAIT_TIME, then press the **Enter** key.
3. Move the cursor to SOURCE to set the source wait time, then press the **Enter** key.
4. Press the arrow keys to set the N value shown in the formula below.
5. Press the **Enter** key to make the setup effective, or press the **Exit** key to cancel changing the setup.
6. Move the cursor to MEASURE to set the measurement wait time, then press the **Enter** key.
7. Press the arrow keys to set the N value shown in the formula below.
8. Press the **Enter** key to make the setup effective, or press the **Exit** key to cancel changing the setup.
9. Press the **Exit** key twice to close the setup menu.

Wait Time

The measurement wait time is the time the measurement channel always waits before starting measurement. The source wait time is the time the source channel always waits before changing the output value. Each wait time is given by the following formula:

$$\text{wait time} = N \times \text{reference}$$

where *reference* is the wait time the Agilent E5260/E5270 automatically sets; this wait time cannot be changed. Available N values are 0.0 to 10.0. The initial value is 1.0.

NOTE

It is not easy to determine the best wait time. If you specify it too short, the measurement may start before device characteristics stable. If too long, time will be wasted.

The initial wait time may be too short for measurements of high capacitance or slow response devices. Then set the wait time longer.

For measurements of low capacitance or fast response devices, if measurement speed has top priority or is more important than reliability and accuracy, set the wait time shorter.

To Set Data Display Format

This instruction selects the display format of the measurement data displayed in the Measurement Data area.

1. Press the **Menu** key.
2. Move the cursor to DSPL_FRMT, then press the **Enter** key.
3. Press the arrow keys to select the format ENGINEERING or SCIENTIFIC.

Display Format	Description
ENGINEERING	Six-digit numeric value with arithmetic point, and unit. Example: +123 . 456pA
SCIENTIFIC	Four-digit numeric value with arithmetic point, exponential part (E, +/- sign, and one- or two-digit numeric value), and unit. Example: +1 . 234E-10A

4. Press the **Enter** key to make the setup effective, or press the **Exit** key to cancel changing the setup.
5. Press the **Exit** key to close the setup menu.

6

Function Details

Function Details

This chapter explains the following measurement functions of the Agilent E5260/E5270, and the initial settings.

- “Measurement Mode”
- “Ranging Mode”
- “Compliance”
- “SMU Pulse”
- “Measurement Time”
- “Atto Sense and Switch Unit”
- “Filter”
- “Series Resistor”
- “Interlock Function”
- “Auto Power Off Function”
- “Initial Settings”

Measurement Mode

The Agilent E5260/E5270 provides different measurement functions for each operation mode; local and remote.

Measurement Mode in Local Condition

You can select one from the following measurement items:

- Current (when applying voltage) or voltage (when applying current)
- Current and voltage
- Power (=voltage×current)
- Resistance (=voltage/current)

Press the **Single** key to perform one point measurement, or the **Repeat** key to perform repeat measurement.

Measurement Mode in Remote Condition

You can select one of the following measurement modes:

- **Spot Measurement**
Applies voltage or current, then measures voltage or current. A maximum of eight measurement channels can be used.
- **Staircase Sweep Measurement**
Applies staircase sweep voltage or current, and measures voltage or current at each sweep step. A maximum of eight measurement channels can be used, and an extra sweep source forces the staircase sweep output synchronized to the primary sweep output.
- **Multi Channel Sweep Measurement**
Applies staircase sweep voltage or current using multiple sweep sources, and performs staircase sweep measurement. A maximum of eight sweep sources and eight measurement channels can be used.
- **Pulsed Spot Measurement**
Applies pulsed voltage or current, and measures voltage or current.
- **Pulsed Sweep Measurement**
Applies pulsed sweep voltage or current, and measures voltage or current at each sweep step. An extra sweep source can be used to force the staircase sweep output synchronized to the pulsed sweep output.
- **Staircase Sweep with Pulsed Bias Measurement**
Applies pulsed voltage or current, and performs staircase sweep measurement. The staircase sweep output is synchronized to the pulsed bias. A synchronous staircase sweep source is also available.
- **Quasi-pulsed Spot Measurement**
Applies quasi-pulsed voltage or current, and measures voltage or current.
- **Search Measurement (linear search and binary search)**
Applies voltage or current, and measures voltage or current. Repeats this for various output values until the search stop condition is satisfied. Synchronous output is available.

To perform measurement, refer to *Programming Guide*.

Ranging Mode

The Agilent E5260/E5270 provides the following operation modes for the measurement range and the output range. The ranging mode must be set for each channel.

- “Auto Ranging”
- “Limited Auto Ranging”
- “Compliance Range”
- “Fixed Range”

To Set the Ranging Mode

The following points must be noted when setting the ranging mode.

For measurement channels

- If you do not specify the ranging mode, the auto ranging mode is set automatically.
- For the channels that perform Vf/Vm (voltage force and voltage measurement) or If/Im (current force and current measurement), the measurement range is always the same as the output range.
- For measurement with pulse output, the measurement channel uses the compliance range or the specified fixed range. The channel cannot perform the auto ranging operation or the limited auto ranging operation.
- If the voltage output range is changed when the DV, DI, XE, or CL command is executed, the voltage measurement range is automatically set to the voltage output range or the compliance range.
- If the current output range is changed when the DV, DI, XE, DZ, or CL command is executed, the current measurement range is automatically set to the current output range or the compliance range.

For output channels

- The auto ranging mode and the limited auto ranging mode are available for the output channels.
- When the voltage output range or the voltage compliance range is changed, the channel forces 0 V at that moment.

Auto Ranging

Range changing is performed as below.

For measurement channels

The measurement channel automatically searches for and measures at the range that provides the best resolution as follows:

- For current measurement, the measurement channel uses the present range if the following formula is satisfied; otherwise, the channel changes the range.

$$\text{Range} \times 0.1 \leq \text{Measurement value} \leq \text{Range} \times X/100$$

where X=115, or 100 at the maximum range.

See also “Enhanced Auto Ranging for Current Measurement” on page 6-8.

- For voltage measurement, the measurement channel uses the present range if the following formula is satisfied; otherwise, the channel changes the range.

$$\text{Next lower range value} \leq \text{Measurement value} \leq \text{Range} \times X/100$$

where X=110, or 100 at the maximum range.

For output channels

The output channel automatically searches for and forces at the lowest range that covers the output value as follows:

- For staircase sweep output, the output channel uses the lowest range that covers the start and stop values. However, it uses the lowest range that covers the step output value for the logarithmic current sweep. For the voltage sweep that sets the power compliance, the channel uses the lowest range (20 V range or more) that covers the step output value.
- For pulsed bias output, the output channel uses the lowest range that covers the base and peak values.
- For pulsed sweep output, the output channel uses the lowest range that covers the base, start, and stop values.
- For quasi-pulsed output and search source output, the output channel uses the lowest range that covers the start and stop values.

The maximum output value is as follows:

- Maximum current output value = $\text{Range} \times X/100$

where X=115, or 100 at the maximum range.

- Maximum voltage output value = Range value

Limited Auto Ranging

Limited auto ranging is similar to auto ranging. However, limited auto ranging does not use the range(s) less than what you specified. For example, if you select 10 mA limited auto ranging, the measurement unit does not use the 1 mA range or less. Consequently, the measurement time for limited auto ranging is less than for auto ranging.

Fixed Range

The channel uses the specified range only.

For the current measurement channel, if you specify a range higher than the compliance range, the measurement channel uses the compliance range. See “Compliance Range” on page 6-7.

Compliance Range

The compliance range is effective for the Vf/Im (voltage output and current measurement) or If/Vm (current output and voltage measurement) channel. The measurement channel automatically selects and uses the lowest range that covers the specified compliance value.

For the measurement channel that performs source output set by the DI or DV command, you can set the compliance ranging type. If you set it to limited auto ranging, the channel does not use a range less than the specified range.

For the measurement channel that performs sweep output, you can set the power compliance value. If you set the power compliance value, the channel uses the lowest range that covers the lower value of either the specified compliance value or the compliance value given by the following formula:

Current compliance = Specified power compliance value / Step voltage

Voltage compliance = Specified power compliance value / Step current

For details about setting compliance, refer to “Compliance” on page 6-9.

NOTE

Range change is performed when the compliance value is set, not when the measurement is performed.

Enhanced Auto Ranging for Current Measurement

Expanded functions are available for the auto ranging operation of the current measurement channel. To use the functions, execute the RM command. The RM command selects the following operation mode and the rate value. The rate value defines the boundary of ranging.

- Mode 1:
Performs normal auto ranging operation. If a condition shown below is satisfied, the range changes immediately, even during measurement.

$$\text{Measurement value} > \text{Range} \times X/100$$

$$\text{Measurement value} \leq \text{Range} \times 0.1$$

where $X=115$, or 100 at the maximum range.

- Mode 2:
If the following condition is satisfied, the range changes up after measurement.

$$\text{Measurement value} \geq \text{current1}$$

- Mode 3:
If the following condition is satisfied, the range changes down immediately, even during measurement.

$$\text{Measurement value} \leq \text{current2}$$

If the following condition is satisfied, the range changes up after measurement.

$$\text{Measurement value} \geq \text{current1}$$

where *current1* and *current2* are given by the following formula. Then *rate* must be an integer, 11 to 100.

$$\text{current1} = \text{Range} \times \text{rate}/100$$

$$\text{current2} = \text{Range} \times \text{rate}/1000$$

For 200 mA, they must be:

$$\text{current1} = 200 \text{ mA} \times \text{rate}/100$$

$$\text{current2} = 100 \text{ mA} \times \text{rate}/100$$

For example, if the range value is 10 mA and *rate* is 90, they are:

$$\text{current1} = 9 \text{ mA}$$

$$\text{current2} = 0.9 \text{ mA}$$

Compliance

Compliance is the output limiter to prevent damage to the test device from overcurrent, overvoltage, or overpower. Voltage compliance is for the current output channels, and current compliance is for the voltage output channels.

When a channel reaches compliance, the channel acts as a constant voltage source or a constant current source. The channel keeps the output value when reaching compliance.

Compliance can be set with the same resolution and accuracy as output current or output voltage. For the values, refer to “Specifications” on page 2-26.

Polarity and Output Area

- Polarity of current compliance

The Agilent E5260/E5270 automatically sets current compliance for both positive and negative polarity. For opposite polarity as the output voltage, the compliance value is increased by an amount that is 2.5 % to 12 % of the range value in the lowest range that covers the specified compliance value. See Figure 6-1.

- Polarity of voltage compliance

The Agilent E5260/E5270 automatically sets voltage compliance to the same polarity as the output current. There is no compliance for opposite polarity.

Figure 6-1

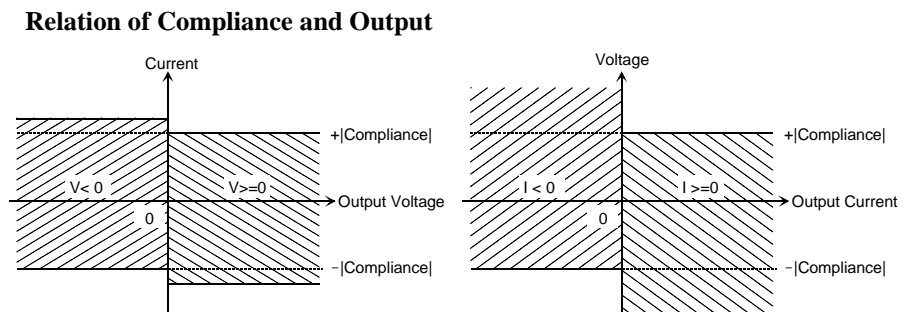

Function Details

Compliance

Polarity of DV/DI output

DV and DI commands enable you to specify the polarity mode, auto or manual.

Auto Sets the compliance as described above. Initial setting.

Manual Sets the compliance as described below.

- Polarity of current compliance

The Agilent E5260/E5270 automatically sets current compliance for both positive and negative polarity. For opposite polarity as the specified compliance value, the compliance value is increased by an amount that is 2.5 % to 12 % of the range value in the lowest range that covers the specified compliance value. See Figure 6-2.

- Polarity of voltage compliance

If the output current is the same polarity as the specified compliance value, the compliance works as the maximum voltage limiter for the same direction as the compliance polarity. For opposite polarity, the compliance works as the minimum voltage limiter. See Figure 6-3.

Figure 6-2

Relation of Compliance and Output (DV, Manual Mode)

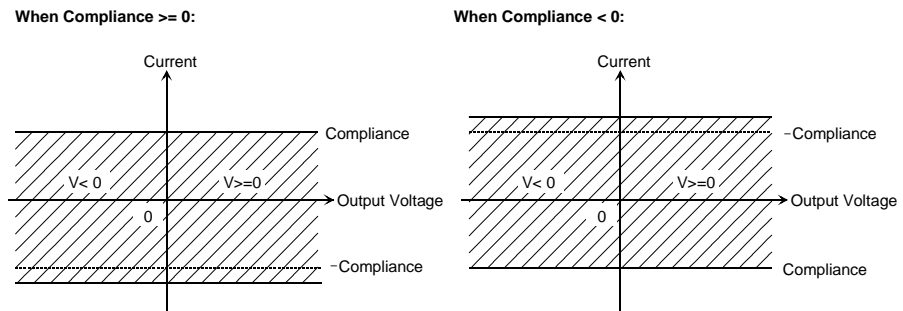
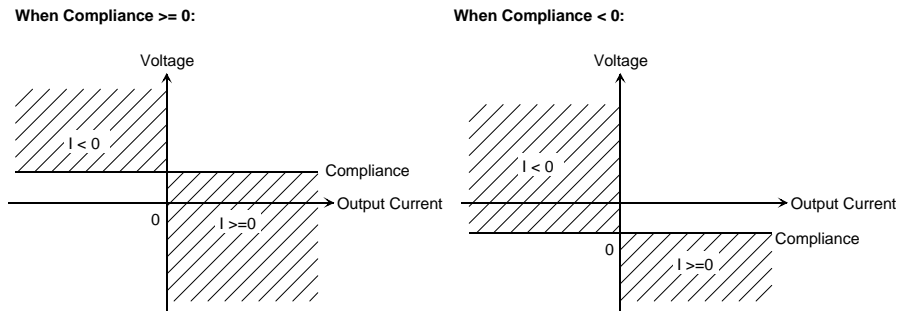

Figure 6-3

Relation of Compliance and Output (DI, Manual Mode)



Power Compliance

In addition to V compliance or I compliance, you can set power compliance for the staircase sweep source. Power compliance is set by the WI, WV, WSI, WSV, or WNX command.

If you specify power compliance, the source/monitor unit (SMU) changes the current or voltage compliance value every sweep step. The value is the lower value of either the specified compliance value or the compliance value given by the following formula. See Figure 6-4.

Current compliance = Specified power compliance value / Step voltage

Voltage compliance = Specified power compliance value / Step current

Figure 6-4

Power Compliance Output Area

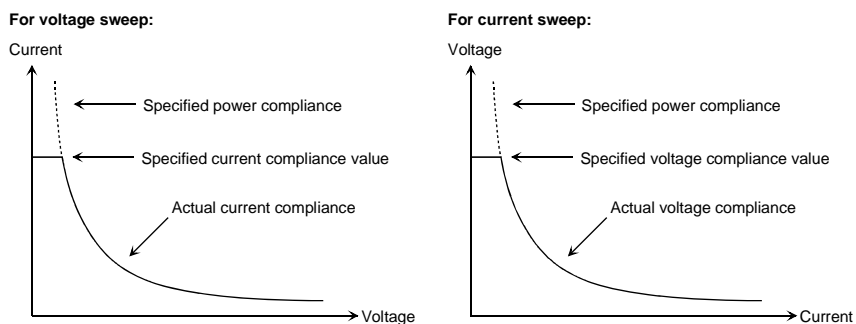

Available values

The following values are available for the power compliance:

MPSMU 1 mW to 4 W

HPSMU 1 mW to 20 W

Conditions after compliance

When a channel reaches compliance, the staircase sweep source automatically stops the sweep and forces the start value. For the measurement data after reaching the compliance, the dummy data 199.999E+99 will be returned.

Function Details

Compliance

SMU output values If you specify power compliance, the SMU changes the current or voltage compliance every sweep step. Hence, the SMU can apply voltage or current with the maximum power. Figure 6-5 shows the differences between the output with power compliance and the output without power compliance, for MPSMU.

Figure 6-5

Allowable Current in Voltage Sweep (0 V to 100 V, MPSMU)

When power compliance is set:

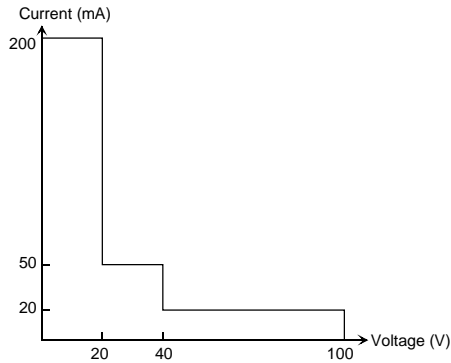

When power compliance is not set:

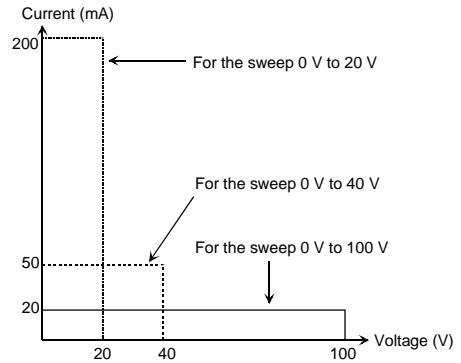

NOTE

If you specify power compliance, the measurement time increases slightly because the E5260/E5270 adjusts the compliance for every sweep step.

To Set Compliance

The following points must be noted when setting the compliance.

- If the current compliance value is too low, the SMU will take a long settling time.
- The SMU will reach voltage compliance if the SMU cannot force the specified current for the following reasons:
 - Over current for test device.
 - Another channel has reached compliance.
 - Current measurement data of another channel has reached the limit for the present measurement range.
- If you set the manual mode for compliance polarity of the DI command, set the voltage compliance value as shown below. See Figure 6-6.
 - If the output current is a positive value or zero ($I_{set} \geq 0$):
Set the compliance value to more than V_{ref} .
 - If the output current is a negative value ($I_{set} < 0$):
Set the compliance value to less than V_{ref} .

In Figure 6-6, ΔI is 2.5 % to 12 % of the range value in the current output range.

Figure 6-6

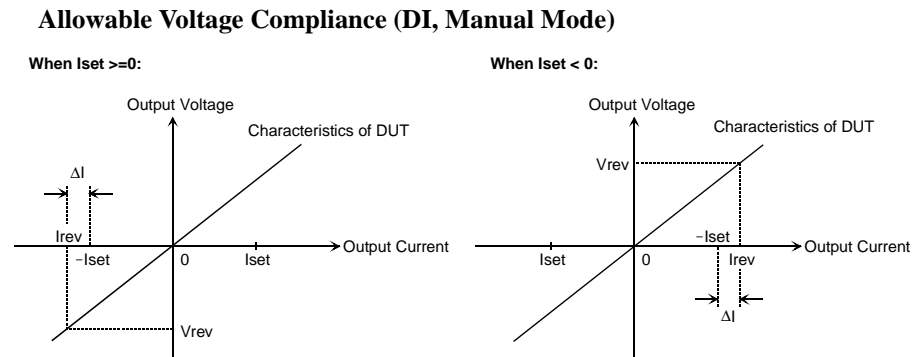

NOTE

If you set the manual mode for compliance polarity of the DI command, and if you do not set the allowable compliance value, the SMU may force I_{rev} , not I_{set} . Refer to “Operation of SMU in Current Output” on page 6-14.

Operation of SMU in Current Output

The I/V characteristics of the SMU in current output is determined by the current output value (I_{set}) and the voltage compliance value. Refer to Figure 6-7.

The SMU output depends on the SMU I/V characteristics and the characteristics of the test device (DUT). The output value will be I_{set} , V_{comp} , or I_{rev} . To force the I_{set} value, the voltage compliance must be set to the allowable value shown in Figure 6-6. If you do not set the allowable compliance value, the SMU forces the I_{rev} value as shown in Figure 6-8.

In Figure 6-7, ΔI is 2.5 % to 12 % of the range value in the current output range.

Figure 6-7

SMU I/V Characteristics

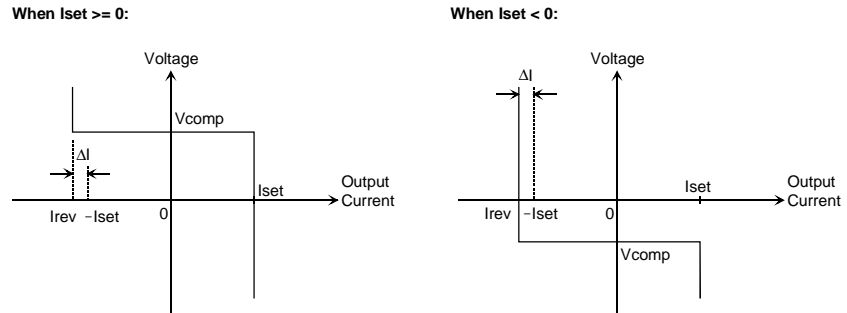
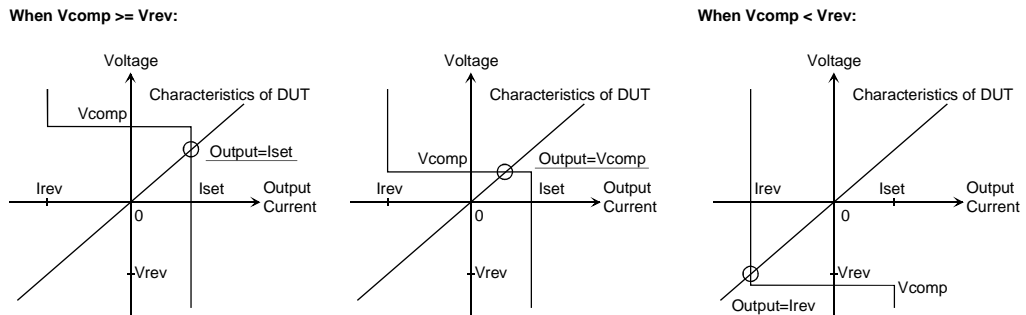

Figure 6-8

SMU Output Transition ($I_{set} \geq 0$, resistance load)



SMU Pulse

The source/monitor unit (SMU) can apply voltage or current pulse. The PI, PV, PWI, or PWV command is used to set the pulse output. The PT command is used to set the pulse timing parameters.

The following values are available for the pulse width and pulse period:

Pulse width 0.5 ms to 2 s, 0.1 ms resolution

Pulse period 5 ms to 5 s, 0.1 ms resolution

where the parameters must satisfy the following conditions:

- $\text{period} \geq \text{width} + 2 \text{ ms}$ (for pulse width $\leq 100 \text{ ms}$)
- $\text{period} \geq \text{width} + 10 \text{ ms}$ (for pulse width $> 100 \text{ ms}$)

To Set Pulse Output

The following points must be noted when setting the pulse output.

- The 1 nA range cannot be used.
- Multiple measurement channels cannot be used.
- The measurement channel uses the compliance range or the specified fixed range. The channel cannot perform the auto ranging operation or the limited auto ranging operation.
- If the measurement range differs from the compliance range, the SMU might not perform the pulsed output specified.

Measurement Time

Measurement time depends on integration time, measurement range, and other measurement conditions, and can be expressed by the following formula:

$$\text{Measurement time} = \text{Integration time} + \text{Overhead time}$$

Integration time is the time required for measurement, and does not include such factors as range changing or data compensation, which would be the overhead time.

Integration Time

Integration time is the time required to get measurement data. For accurate and reliable measurement, integration time should be increased. Integration time can be set for each type of A/D converter (ADC) used by the measurement channel.

For the Agilent E5260, see the description of the high-speed ADC. The high-resolution ADC is equipped with the Agilent E5270B only.

- High-speed ADC

You can adjust the number of averaging samples instead of the integration time. For high speed measurement. Installed in each measurement module.

- High-resolution ADC

Available only for the Agilent E5270B. You can adjust the integration time directly. For high accuracy and high resolution measurement. This ADC is mounted on the mainframe, and used by the multiple modules alternately.

To set the integration time or the number of averaging samples, select the mode and set the value as shown in Table 6-1. For the Agilent E5260, see the description of High Speed ADC.

ADC Zero Function

Available only for the E5270B. The ADC zero function is available for the high-resolution A/D converter (ADC) and not available for the high-speed ADC. This function measures the internal offset of the high-resolution ADC and compensates it automatically. The measurement data displayed on the LCD will be the data after compensation.

NOTE

This function is especially effective for the low voltage measurement. Disable the function in cases where measurement speed is more important than measurement accuracy. This approximately halves integration time.

Table 6-1

Integration Time and Number of Samples

ADC	Mode	Description
High Speed ADC	Auto	<p>$Number\ of\ averaging\ samples = N \times reference$</p> <p>where <i>reference</i> is the number of averaging samples automatically set by the Agilent E5260/E5270; this cannot be changed.</p> <p>Specify the <i>N</i> value shown above. Available values are 1 to 1023. Initial value is 1.</p>
	Manual	<p>Specify the number of averaging samples (<i>N</i>).</p> <p>Available values are 1 to 1023. Initial value is 1.</p>
	PLC	<p>$Number\ of\ averaging\ samples = N \times 128$</p> <p>Specify the <i>N</i> value shown above. Available values are 1 to 100. Initial value is 1.</p> <p>The Agilent E5260/E5270 gets 128 samples in a power line cycle. Hence, the <i>N</i> value is equal to the number of power line cycles.</p>
High Resolution ADC	Auto	<p>$Integration\ time = N \times reference$</p> <p>where <i>reference</i> is the integration time automatically set by the Agilent E5270B; it cannot be changed.</p> <p>Specify the <i>N</i> value shown above. Available values are 1 to 127. Initial value is 6.</p>
	Manual	<p>$Integration\ time = N \times 80\ \mu sec$</p> <p>Specify the <i>N</i> value shown above. Available values are 1 to 127. Initial value is 3.</p>
	PLC	<p>$Integration\ time = N / power\ line\ frequency$</p> <p>Specify the <i>N</i> value shown above. Available values are 1 to 100. Initial value is 1.</p> <p>The <i>N</i> value means the number of power line cycles.</p>

Overhead Time

The overhead time is the time required for range changing and so on. This time depends on the measurement condition, and cannot be specified. Major elements of the overhead time are:

- Range changing time during measurement (when measurement ranging mode is set to auto or limited auto)
- Range changing time at measurement start (when the measurement range is less than the compliance value)

To Specify Source Output Time

As shown in the discussion of the overhead time, you cannot specify the measurement time. However, in sweep measurement mode, you can specify a source output time that includes the measurement time. To specify the source output time, set the delay time and the step delay time. The step delay time is defined as the time from the measurement trigger up to the trigger for changing the source output value. See the figure below.

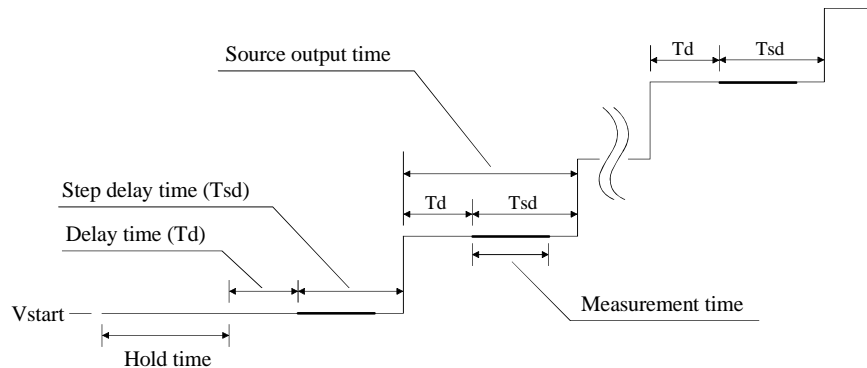

The step delay time must cover the measurement time to keep the source output time constant.

These values can be set by the WT command.

Wait Time

Wait time is the time after starting source output until changing the source output value or until starting measurement. You can set the source wait time and the measurement wait time individually.

The source wait time is the time the source channel always waits after it starts output until it changes the output value. The measurement wait time is the time the measurement channel always waits after the source channel starts output until the measurement channel starts measurement. Refer to Figure 6-9. The wait time is given by the following formula:

$$\text{wait time} = N \times \text{reference}$$

where *reference* is the wait time the Agilent E5260/E5270 automatically sets according to the present settings; this wait time cannot be changed. Available *N* values are 0 to 10, 0.1 step. Initial value is 1.

It is not easy to determine the best wait time. If you specify it too short, the measurement may start before device characteristics are stable. If too long, time will be wasted. For measurements of low capacitance or fast response devices, if measurement speed has top priority or is more important than reliability and accuracy, set the wait time shorter.

The initial wait time may be too short for measurements of high capacitance or slow response devices. Then set the wait time longer.

Figure 6-9 Source/Measurement Wait Time

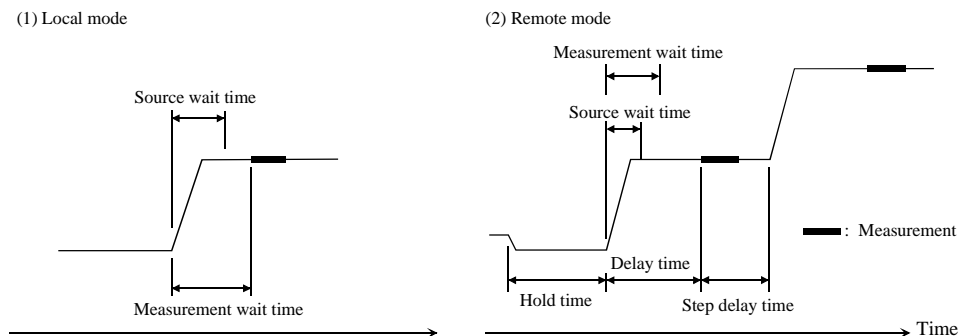

NOTE

In the local mode, you cannot set the hold time, delay time, and step delay time. They are automatically set to 0 s.

In the remote mode, if the delay time is longer than the wait time, the wait time can be ignored.

Atto Sense and Switch Unit

The Agilent E5260 series cannot use the Atto Sense and Switch Unit (ASU). The ASU is available for the Agilent E5270B installed with the high resolution SMU (HRSMU). To use the ASU, connect the ASU to the HRSMU properly. The ASU adds the 1 pA range to the HRSMU. If you use other instrument such as C meter, connect the instrument to the AUX input. The ASU provides the input selection function.

The internal connection can be controlled by the AUX On/Off shift key. See Setup 1 and 2 of Figure 6-10. When the E5270B is turned on, the connection will be the Setup 1. To use the HRSMU, the connection must be the Setup 1. To use the instrument connected to the AUX input, change the connection to the Setup 2. In this condition, the Output indicator in the front panel LCD displays the reversed triangle mark, and the HRSMU cannot be used. The ASU is equipped with the connection status indicator (LED) that shows which input is internally connected to the output.

Figure 6-10

Internal Connection of ASU

Setup 1: AUX Off (SMU input to ASU output)

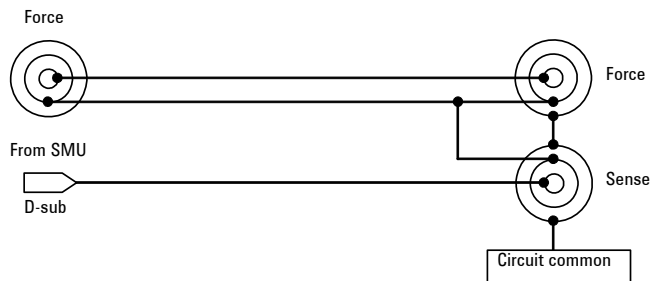

Setup 2: AUX On (CMU/AUX input to ASU output)

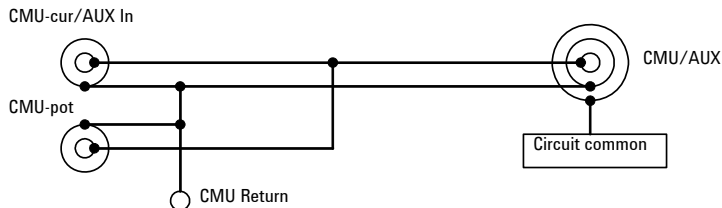

NOTE

Before using ASU

Instrument connection must be done before the Agilent E5270B is turned on.

The ASU can be used with only the HRSMU that was connected to it when the performance verification was performed. See “To Display Module Serial Number” on page 5-13 and confirm that the ASU is the correct one. If it is not correct, get the correct one and connect it to the HRSMU properly.

The CMU-pot connector is for the LCR meter such as the Agilent 4284A that uses the four-terminal-pairs. For the other instrument, connect a BNC open connector or nothing to there. The line will be internally connected to the CMU-cur/AUX-in line.

It is unavailable to use the series resistor in the HRSMU connected to the ASU.

NOTE

Before using 1 pA range

The measurement channel connected to the ASU supports the 1 pA range. To use the 1 pA range, set the 1 pA fixed range or the 1 pA limited auto ranging.

The E5270B automatically performs the compensation of the data measured by the 1 pA range and returns the compensated data. You can use either the pre-stored offset data or the pre-measured offset data.

To measure the offset data, perform the self-calibration before starting the measurement for a DUT. This offset data is temporarily memorized until the E5270B is turned off.

Filter

The filter is mounted on each source/monitor unit (SMU) module. It assures clean source output with no spikes or overshooting. However, using a filter may increase the SMU settling time.

To set the filter, refer to “To Use Filter” on page 5-19.

In remote mode, use the FL command to set the filter ON or OFF.

Series Resistor

The series resistor (approx. 1 M Ω) is mounted on each source/monitor unit (SMU) module. The series resistor may be used for the device protection, negative resistance measurement, and so on. It depends on the characteristics of test device and measurement environment.

If you use a series resistor, the voltage you set is applied to the near side of the series resistor. Thus, the voltage will be divided by the series resistor and the device under test. Then, the measurement data is not compensated.

To set the series resistor, refer to “To Use Series Resistor” on page 5-19.

In remote mode, use the SSR command to set the series resistor ON or OFF.

NOTE

Restrictions

The series resistor cannot be used for the measurements that use the high resolution SMU (HRSMU) connected to the Atto Sense and Switch Unit (ASU) or the measurements that use 1 A range of the high power SMU (HPSMU).

Interlock Function

The interlock function is designed to prevent electrical shock when a user touches the measurement terminals. If the Interlock terminal is open, maximum output is limited to ± 42 V.

To perform high voltage measurement more than ± 42 V, connect the Interlock terminal to an interlock circuit of test fixture or connector plate. The interlock circuit must have one LED and two mechanical switches placed near the shielding box opening doors. And they must be connected together. For details on how to install the interlock circuit, see “To Make an Interlock Circuit” on page 3-23.

The interlock function works as shown below.

- When the interlock circuit is open, maximum output is limited to ± 42 V.
- When the interlock circuit is close, source channel can force its maximum output value.
- When the interlock circuit is opened in the high voltage condition more than ± 42 V, output voltage is set to 0 V immediately.

CAUTION

If the actual output value is not set to 0 V within 120 msec, the Agilent E5260/E5270 automatically performs the initialization. Then perform self-test. Any module may be defective.

WARNING

Dangerous voltage of up to the maximum voltage of SMUs may be present at force, guard, and sense terminals if the Interlock terminal is closed.

Auto Power Off Function

If an abnormal voltage or current is detected in the Agilent E5260/E5270, the Agilent E5260/E5270 automatically turns off to prevent damage.

If this function is activated, the Agilent E5260/E5270 is turned off, but the Line switch is left ON. Perform the following steps to turn the Agilent E5260/E5270 on again.

1. Press the Line switch to set it to the OFF position.
2. Wait for 10 seconds or more.
3. Press the Line switch to set it to the ON position.

Abnormal voltage or current can be caused by incorrect connections of the Agilent E5260/E5270 to the test device, excess voltage or current input, momentary power loss, defects of the instrument, and so on.

If no cable is connected to the measurement terminals of the Agilent E5260/E5270, and the line voltage is correct, the Agilent E5260/E5270 may have a defect. Contact the nearest Agilent Technologies Service Center for assistance.

Initial Settings

Agilent E5260/E5270 is initialized by turning the E5260/E5270 on, the *RST command, or the device clear. Initial settings of the Agilent E5260/E5270 are shown in Table 6-2 and Table 6-3. Table 6-3 fits into one page, and lists all initial settings.

Table 6-2 Initial Settings

Setup Item	Initial Setting		Commands
Measurement channel	Channel assigned the lowest number.		MCH
Measurement data to be displayed	Data 1	Compliance side data	MPA
	Data 2	none	MPA
Output channel	Channel assigned the lowest number.		SCH
Output data to be displayed	Data 1	OUT	SPA
	Data 2	CPL	SPA
Data display format	ENGINEERING		DFM
Remote mode data display	off		RED
Remote mode key lock/unlock	unlock		KLC
Auto calibration	on		CM
ADC zero function (for E5270B)	off		AZ
SMU output switch	open		CN, CL
ASU path/1 pA auto range/indicator	SMU side/disabled/enabled		SAP/SAR/SAL
Filter	off		FL
Series resistor	off		SSR
A/D converter	High speed ADC		AAD
Integration time (High resolution ADC is available for E5270B)	High speed ADC: auto		AIT
	High resolution ADC: auto		AIT

Setup Item	Initial Setting		Commands
AV command parameter	<i>number=1, mode=0</i>		AV
Current measurement range	with pulse	Compliance range	RI
	without pulse	auto	
Voltage measurement range	with pulse	Compliance range	RV
	without pulse	auto	
Sweep source parameters	cleared		WV, WSV, WI, WSI
Automatic sweep abort function	off		WM
Output after sweep measurement	Start value		WM
Pulse source parameters	cleared		PV, PI
Pulse sweep source parameters	cleared		PWV, PWI
Pulse width	0.001 s		PT
Pulse period	0.01 s		PT
Search source parameters	cleared		BSV, BSSV, BSI, BSSI, LSV, LSSV, LSI, LSSV
Search monitor parameters	cleared		BGV, BGI, LGV, LGI
Output after search measurement	Start value		BSM, LSM
Search measurement data	Source output value only		BSVM, LSVM
Quasi-pulse source parameters	cleared		BDV
Quasi-pulsed spot measurement mode	Voltage		BDM
Quasi-pulse settling detection interval	Short		BDM
Hold time	0 s		WT, PT, BDT, BST, LSTM

Function Details
Initial Settings

Setup Item	Initial Setting		Commands
Delay time	0 s		WT, PT, BDT, BST, LSTM
Step delay time	0 s		WT
Trigger delay time	0 s		WT, PT
Trigger mode	XE, TV, TI, or GET		TM
Trigger port	Ext Trig In	Start Measurement trigger input	TGP
	Ext Trig Out	Measurement Completion trigger output	TGP
	Digital I/O	cleared	TGP
Trigger condition of Start Step Output Setup trigger	with trigger for first sweep step		TGSI
Type of output trigger	Edge trigger		TGXO, TGSO, TGMO
Digital I/O port	Output for all port		ERM
Program memory	cleared ^a		SCR
Value of internal variable (%In, %Rn)	0		VAR
Data output format	ASCII with header, CR/LF^EOI		FMT
Data output buffer	cleared		BC
Status byte	Only bit 6 is enabled.		*SRE
Error code register	cleared		ERR?

a. Program memory is not cleared by the *RST command or the device clear.

Table 6-3 Initial Settings

Setup Item	Initial Setting		Commands
Measurement channel	Channel assigned the lowest number.		MCH
Measurement data to be displayed	Data 1	Compliance side data	MPA
	Data 2	none	MPA
Output channel	Channel assigned the lowest number.		SCH
Output data to be displayed	Data 1	OUT	SPA
	Data 2	CPL	SPA
Data display format	ENGINEERING		DFM
Remote mode data display	off		RED
Remote mode key lock/unlock	unlock		KLC
Auto calibration	on		CM
ADC zero function (for E5270B)	off		AZ
SMU output switch	open		CN, CL
ASU path/1 pA auto range/indicator	SMU side/disabled/enabled		SAP/SAR/SAL
Filter/Series resistor	off/off		FL/SSR
A/D converter	High speed ADC		AAD
Integration time (High resolution ADC is available for E5270B)	High speed ADC: auto		AIT
	High resolution ADC: auto		AIT
AV command parameter	<i>number=1, mode=0</i>		AV
Current measurement range	with pulse	Compliance range	RI
	without pulse	auto	
Voltage measurement range	with pulse	Compliance range	RV
	without pulse	auto	
Sweep source parameters	cleared		WV, WSV, WI, WSI
Automatic sweep abort function	off		WM
Output after sweep measurement	Start value		WM
Pulse source parameters	cleared		PV, PI
Pulse sweep source parameters	cleared		PWV, PWI
Pulse width	0.001 s		PT
Pulse period	0.01 s		PT
Search source parameters	cleared		BSV, BSSV, BSI, BSSI, LSV, LSSV, LSI, LSSV
Search monitor parameters	cleared		BGV, BGI, LGV, LGI
Output after search measurement	Start value		BSM, LSM
Search measurement data	Source output value only		BSVM, LSVM
Quasi-pulse source parameters	cleared		BDV
Quasi-pulsed spot measurement mode	Voltage		BDM
Quasi-pulse settling detection interval	Short		BDM
Hold time	0 s		WT, PT, BDT, BST, LSTM
Delay time	0 s		WT, PT, BDT, BST, LSTM
Step delay time	0 s		WT
Trigger delay time	0 s		WT, PT
Trigger mode	XE, TV, TI, or GET		TM
Trigger port	Ext Trig In	Start Measurement trigger input	TGP
	Ext Trig Out	Measurement Completion trigger output	TGP
	Digital I/O	cleared	TGP
Trigger condition of Start Step Output Setup trigger	with trigger for first sweep step		TGSI
Type of output trigger	Edge trigger		TGXO, TGSO, TGMO
Digital I/O port	Output for all port		ERM
Program memory	cleared. Not cleared by *RST command or device clear.		SCR
Value of internal variable (%In, %Rn)	0		VAR
Data output format	ASCII with header, CR/LF^EOI		FMT
Data output buffer	cleared		BC
Status byte	Only bit 6 is enabled.		*SRE
Error code register	cleared		ERR?

Function Details

Initial Settings

7

If You Have a Problem

If You Have a Problem

This chapter explains how to solve a problem or how to read status and error codes, if you encounter some problem, and consists of the following sections:

- “When You Install the E5260/E5270”

This section explains how to solve the problems that may occur when installing the Agilent E5260/E5270.

- “When You Make a Measurement”

This section explains how to solve the problems that may occur when making a measurement.

- “Channel Status Code”

This section lists channel status codes that may be displayed on the LCD when operating the Agilent E5260/E5270.

- “Error Codes”

This section lists codes and messages of errors that may cause when operating the Agilent E5260/E5270.

Error causes if the Agilent E5260/E5270 is not operated correctly, or it fails self-test or calibration.

If error occurs, find solutions in the following sections and solve problems. However, if problems still remain, perform self-test.

If the E5260/E5270 fails self-test, contact your nearest Agilent Technologies Service Center.

NOTE

When shipping the Agilent E5260/E5270 to the service center

When you ship the Agilent E5260/E5270 to the Agilent Technologies service center, do not remove the source monitor unit (SMU) from the mainframe, and ship the mainframe with all SMU modules.

When you ship the Agilent E5270B used with the atto sense/switch unit (ASU), disconnect the connection cables between the ASU and the high resolution source monitor unit (HRSMU), and ship the ASU, connection cables, and the mainframe. Then do not remove any module from the mainframe. The ASU can be used with the dedicated HRSMU. So check the serial number, and ship the proper ASU.

When You Install the E5260/E5270

This section covers the following basic problems that you may encounter when you install the E5260/E5270, and the solutions.

- “If the E5260/E5270 cannot be Powered on”
- “To Simplify the Connections”

If the E5260/E5270 cannot be Powered on

- Check that the power cable is firmly connected to the E5260/E5270 and to power outlet.
- Check that the front-panel Line switch is on.

To Simplify the Connections

If you want to simplify the measurement connections, use the triaxial cables instead of the kelvin triaxial cables, and connect the triaxial cables between the Force terminals and the test fixture or the connector plate. Then the Sense terminals must be opened.

NOTE

The Agilent E5260/E5270 has the Force and Sense terminals to make the kelvin connection. And the kelvin triaxial cables are effective to extend the measurement terminals near by the device under test. Connecting the Force and Sense lines together at the device terminals can minimize the measurement error caused by the residual resistance of the connection cables. The kelvin connection is effective for the low resistance measurement and the high current measurement. Also it is one of the conditions to satisfy the measurement specifications of the Agilent E5260/E5270.

When You Make a Measurement

This section covers the following basic problems that you may encounter when you making a measurement, and the solutions.

- “If Leaving Connections Damages Devices after Measurement”
- “If Measured Value Oscillates when Measuring High-Frequency Devices”
- “If Measured Value Oscillates when Measuring Negative Resistance”
- “If Noise Affects the Measured Values”
- “If Measured Voltage has some Error when Forcing a Large Current”
- “If Large Current Causes High Temperature (Thermal Drift)”
- “If Measurement Takes More Time than Specified”
- “If Measurement Damages the Device under Test”

If Leaving Connections Damages Devices after Measurement

After the measurements, open the measurement terminals or disconnect the device under test from the measurement terminals. If you leave the connection with the device, the device may be damaged by unexpected operations.

Do not leave the connection over 30 minutes after the measurement if the auto calibration is set to ON. Then, the E5260/E5270 performs the self-calibration automatically every 30 minutes after the measurement. The calibration requires to open the measurement terminals.

If Measured Value Oscillates when Measuring High-Frequency Devices

When measuring parameters of high-frequency devices, such as GaAs MESFETs or high-frequency bipolar transistors, oscillation may cause measurement problems. Normal measurement cannot be performed because of oscillation.

To solve this problem:

- For FETs, add resistive ferrite beads as close as possible to the gate.
- For bipolar transistors, add resistive ferrite beads as close as possible to the base or emitter.
- Make connection cables as short as possible. Long wires cause oscillation because of their large inductance.

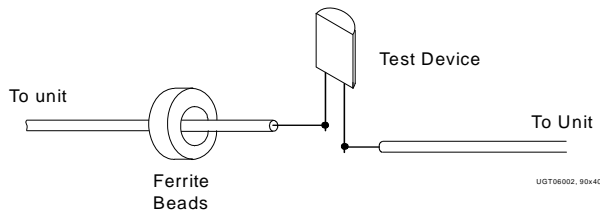

If Measured Value Oscillates when Measuring Negative Resistance

If the DUT has negative resistance characteristics, SMUs may oscillate. Because SMUs operate as negative feedback amplifier.

To solve this problem:

- For voltage controlled negative resistance device
 - Connect G in parallel with your DUT to cancel negative resistance. To obtain an output I-V curve, use the following equation.

$$IY = I - G \times V$$

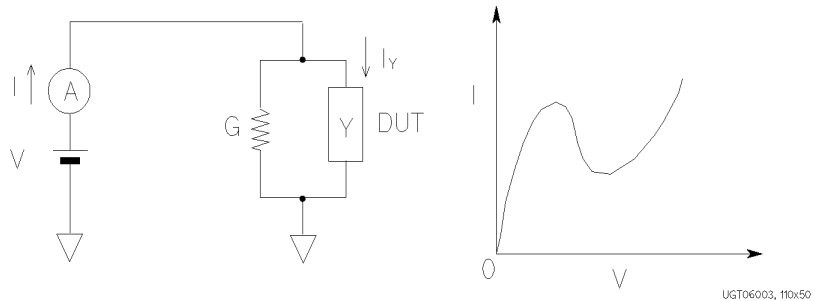

- For current controlled negative resistance device
 - Connect R in series with your DUT to cancel negative resistance. To obtain an output I-V curve, use the following equation.

$$VZ = V - R \times I$$

- If the resistance of the DUT is less than 1 MΩ, you can use a series resistor built into the SMU.

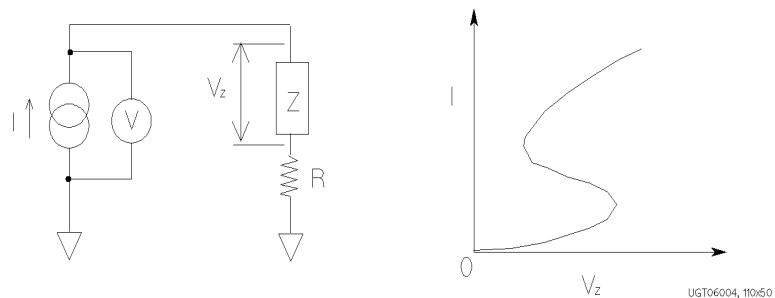

If Noise Affects the Measured Values

When you measure low current of a DUT, the measured values may not be stable.

To solve this problem:

- Set the power line frequency correctly. The value affects the integration time. So the wrong value causes the measurement error by the power line noise.
- Use guarding to reduce the leakage current between your prober and the E5260/E5270. Note that long wires cause oscillation because of their large inductance.
- If some high-power electric machines are operating around the E5260/E5270, turn off the machines, then perform the measurements. The machines affect the power line waveform.
- Shut the lid of test fixture or shield box to prevent effects of light.
- If these are vibrations due to nearby machines or due to air flow, put cushioning material under prober, cable, and the E5260/E5270; install stabilizer on the prober; and make the cables stable by taping.
- Wait several minutes after connecting cables or moving probe needles. Because these operations cause electromotive force.
- If you use only Force terminal and triaxial cables, connect an open cap to Sense terminal.
- Keep constant temperature in the room when you use the E5260/E5270. Shift of 1 °C may shift the measurement values. Temperature change causes the following.
 - Offset current in the E5260/E5270.
 - Thermoelectromotive force in DUT, which causes low current.
 - Expansion and contraction of cables, which causes noise.

If Measured Voltage has some Error when Forcing a Large Current

Voltage measurement may have some error because of the effects of the cable resistance when forcing a large current.

To solve this problem:

- Use kelvin connections between SMUs and DUT. To cancel the effects of cable resistance, connect the sense line as close as possible to the terminal of the DUT.

If Large Current Causes High Temperature (Thermal Drift)

If a large current is forced to a DUT, the temperature of the DUT may increase, which may cause characteristics to drift.

To solve this problem:

- Use the pulse output mode of the SMU.
For large currents, the SMU should be set to pulse output mode. This decreases the average power output to prevent temperature rise of DUT.

If Measurement Takes More Time than Specified

If you set many measurement channels, auto ranging mode, or too long integration time, measurement takes a longer time.

To solve this problem:

Depending on your measurement requirements, perform following:

- Decreases measurement channels.
- Uses limited auto ranging mode.
- Uses fixed range.
- Decreases averaging samples of the high-speed A/D converter.
- Decreases integration time of the high-resolution A/D converter (for E5270B).
- Disables the ADC zero function (for E5270B).

If Measurement Damages the Device under Test

When performing breakdown measurements, DUTs may be damaged.

When voltage is forced from an SMU, the current is limited by the compliance setting, which prevents the DUT from being damaged by a large current. But when the current rapidly increases, the current limiter in the SMU cannot follow the rapid current increase, so a large amount of current may flow through the DUT for a moment, which may damage the DUT.

To solve this problem:

- Insert a protecting resistor as close as possible to DUT. You can also use a series resistor built into the SMU.

Channel Status Code

The channel status code indicates the following statuses of the measurement channel, and is displayed in the channel status area on the LCD. No status code is displayed if the Agilent E5260/E5270 is in the normal condition.

- X** One or more channels are oscillating.
- V** Measurement data exceeds the measurement range.
- C** This channel reached its compliance setting.
- T** Another channel reached its compliance setting.

The status priority is:

$X > V > C > T$

Error Codes

If errors occur, error codes are stored in the error buffer. To read the error code, execute the “ERR?” command. To read the error message, execute the “EMG?” command.

The output of the error codes is in the order that they occurred, and the first four error codes are stored in the buffer. If no errors occurred, “0, 0, 0, 0” is returned.

Operation Error

- | | |
|------------|--|
| 100 | Undefined GPIB command.
Send the correct command. |
| 102 | Incorrect numeric data syntax.
Correct the data syntax. |
| 103 | Incorrect terminator position.
Correct the command syntax. The number of parameters will be incorrect. |
| 120 | Incorrect parameter value.
Correct the parameter value. |
| 121 | Channel number must be 1 to 2, or 1 to 8.
Correct the channel number. The channel number must be 1 to 2 for the Agilent E5262A/E5263A, or 1 to 8 for the Agilent E5260A/E5270B. |
| 122 | Number of channels must be corrected.
Check the MM, FL, CN, CL, IN, DZ, or RZ command, and correct the number of channels. |
| 123 | Compliance must be set correctly.
Incorrect compliance value was set. Set the compliance value correctly. |
| 124 | Incorrect range value for this channel.
Check the range value available for the channel, and correct the range value. |

If You Have a Problem

Error Codes

- 126** Pulse base and peak must be same polarity.
The polarity of the base and peak values must be the same in the PI command. Also the polarity of the base, start, and stop values must be the same in the PWI command.
- 130** Start and stop must be same polarity.
For a log sweep, the polarity of the start and stop values must be the same in the WV, WI, WSV, WSI, or WNX command. Also, 0 is not allowed for the start and stop values.
- 150** Command input buffer is full.
The Agilent E5260/E5270 can receive 256 characters maximum including the terminator at one time.
- 152** Cannot use failed module.
The channel number specifying the module failed the self-test or calibration. Specify another module that passed the self-test or calibration. For the service purpose, execute the RCV command to enable the module.
- 153** No module for the specified channel.
Module is not installed in the slot specified by the channel number.
- 160** Incorrect ST execution.
The internal memory programming can be started by the ST command and completed by the END command. Do not enter the ST command between the ST command and the END command.
- 161** Incorrect END execution.
The internal memory programming can be started by the ST command and completed by the END command. Do not send the END command before starting the programming.
- 162** Incorrect command for program memory.
Specified command cannot be stored in the program memory. For the incorrect commands, refer to Table 2-1 in Programming Guide.

- 170** Incorrect usage of internal variable.
The internal variable must be %In for integer data, or %Rn for real data. where *n* is an integer, 0 to 99. Use %In for the integer type command parameters; and use %Rn for the real type command parameters. For the internal variables, refer to “VAR” command in Programming Guide.
- 171** Internal variable is not allowed.
The internal variables %In and %Rn are not available for the ACH, VAR, and VAR? commands. Do not use the internal variables for the commands.
- 200** Channel output switch must be ON.
To enter the specified command, set the channel output switch to ON.
- 201** Compliance must be set.
To change the source output mode (voltage or current), set the compliance value.
- 202** Interlock circuit must be closed.
To set the output voltage or the voltage compliance to more than ± 42 V (high voltage state), close the interlock circuit. If the interlock circuit is opened in the high voltage state, outputs of all units will be set to 0 V.
- 203** Cannot enable channel.
The channel output switch cannot be set to ON in the high voltage state. Set the output voltage or the voltage compliance to ± 42 V or less to set the switch to ON.
- 204** Cannot disable channel.
The channel output switch cannot be set to OFF in the high voltage state. Set the output voltage or the voltage compliance to ± 42 V or less to set the switch to OFF. Or send the CL command with no parameter to set switches of all channels to OFF immediately.
- 205** DZ must be sent before RZ.
The RZ command is effective for the channels set to 0 V output by the DZ command.

If You Have a Problem

Error Codes

- 206** Do not specify the channel recovered by RZ.
Specify the channels that have not been recovered yet by the RZ command after the DZ command. The RZ command cannot be executed if the specified channels include a channel that has already been recovered by the RZ command.
- 210** Ext trigger could not start measurement.
External trigger cannot start measurement because of busy condition.
- 211** TM1 must be sent to use GET.
Send the TM1 command to use the GPIB GET command (TRIGGER statement in HP BASIC).
- 212** Compliance must be set correctly.
Compliance was not set or an incorrect compliance value was set in the DV, DI, PV, PI, PWV, PWI, TDV, TDI, LSV, LSI, LSSV, LSSI, BSV, BSI, BSSV, or BSSI command. Set the compliance value correctly.
- 213** Cannot perform self-test or calibration.
Self-test and calibration cannot be performed in the high voltage state. Set the output voltage or the voltage compliance to ± 42 V or less to perform the self-test or calibration.
- 214** Send MM before measurement trigger.
Before sending the measurement trigger, the MM command must be sent to set the measurement mode.
- 220** Send WV or WI to set primary sweep source.
Before triggering the staircase sweep measurement, triggering the staircase sweep with pulsed bias measurement, or sending the WSV, WSI, or WNX command to set the synchronous sweep source, send the WV or WI command to set the primary sweep source.
- 221** Send PWV or PWI to set pulse sweep source.
Before triggering the pulsed sweep measurement, or sending the WSV or WSI command to set the synchronous sweep source, send the PWV or PWI command to set the pulse sweep source.
- 222** Send PV or PI to set pulse source.
Before triggering the staircase sweep with pulsed bias measurement, send the PV or PI command to set the pulse source.

- 223** Compliance must be set correctly.
Compliance was not set or an incorrect compliance value was set in the WV, WI, WSV, WSI, WNX, or BDV command. Set the compliance value correctly.
- 224** Sweep and sync output modes must be the same.
The primary sweep channel and the synchronous sweep channel must be different, and they must be set to the same output mode (voltage or current).
- 225** Send WSV, WSI, or WNX to get sync sweep data.
If you enable data output of the synchronous sweep source, do not forget to set the synchronous sweep source by the WSV, WSI, or WNX command. For data output, refer to “FMT” command in Programming Guide.
- 226** Set linear sweep for MM4 or MM5.
Only the linear sweep is available for the PWV or PWI command for the pulsed sweep measurement (MM4) or the WV or WI command for the staircase sweep with pulsed bias measurement (MM5).
- 227** Sweep measurement was aborted.
Sweep measurement was aborted by the automatic sweep abort function or the power compliance.
- 230** Pulse source must be set.
To perform the pulsed spot measurement (MM3), send the PV or PI command to set the pulse source.
- 231** Compliance must be set correctly.
Compliance was not set or an incorrect compliance value was set in the PV, PI, PWV, or PWI command. Set the correct compliance value effective for the pulse output.
- 238** Too large pulse width (max. 2 s).
The maximum value of the pulse width is 2 s. And the available value depends on the pulse period value. Refer to “PT” command in Programming Guide.
- 239** Pulse width must be 0.5 ms or more.
Set the pulse width to 0.5 ms or more. Refer to “PT” command in Programming Guide.

If You Have a Problem

Error Codes

- 253** Program memory is full.
Maximum of 2000 programs or 40000 commands can be stored in the program memory. Refer to “ST” command in Programming Guide.
- 254** Invalid input for a memory program.
The GPIB GET command (TRIGGER statement in HP BASIC) and an external trigger input are not allowed in a memory program (between the ST and END commands).
- 255** Maximum nesting level is eight.
Nesting (one program calling another) of a memory program must be eight levels or less.
- 260** Data output buffer is full.
Maximum 34034 measurement data items can be stored in the data output buffer.
- 270** Search source channel must be set.
Before triggering the search measurement or sending the LSSV, LSSI, BSSV, or BSSI command to set the synchronous search source, send the LSV, LSI, BSV, or BSI command to set the primary search source.
- 271** Search monitor channel must be set.
Before triggering the search measurement, send the LGV, LGI, BGV, or BGI command to set the search monitor channel.
- 273** Search and sync output modes must be the same.
The primary search source channel and the synchronous source channel must be different, and they must be set to the same output mode (voltage or current).
- 274** Search sync source is overflow.
Set the search sources so that the same output range is set to both primary and synchronous search sources.
- 275** Search target must be compliance value or less.
The search target value must be less than or equal to the compliance value of the search monitor channel. Correct the search target value or the compliance value.
- 276** Start and stop must be different.
Set different values for the search start and stop values.

- 277** Step must be output resolution or more.
Set the search step value to the output resolution or more.
- 278** Search and sync channels must be different.
Set the search source and the synchronous source to different channels.
- 279** Search monitor mode must be compliance side.
Send the LGI/BGI command to set the voltage source search monitor channel, or send the LGV/BGV command to set the current source search monitor channel.
- 303** Excess voltage in MPSMU.
Voltage that exceeds maximum voltage at the present current range was detected by a MPSMU. All output switches were set to OFF.
- 305** Excess current in HPSMU.
Current that exceeds maximum current at the present voltage range was detected by a HPSMU. All output switches were set to OFF.
- 307** Unsupported module.
This module is not supported by this firmware version. Until you update the firmware, use the Agilent E5260/E5270 with this module removed.
- 310** Interlock open operation error. Initialized.
Initialization was automatically performed because the E5260/E5270 failed to set its output to 0 V when the interlock circuit was opened in the high voltage condition. Any module may be defective. Perform self-test.
- 311** ASU control cable was connected/disconnected.
The E5270B must be turned off when the Atto Sense and Switch Unit (ASU) is connected/disconnected.
- 603** Sweep and pulse channels must be different.
Set the sweep source and the pulse source to different channels for the staircase sweep with pulsed bias measurement (MM5).
- 610** Quasi-pulse source channel must be set.
Before triggering the quasi-pulsed spot measurement, send the BDV command to set the quasi-pulse source.

If You Have a Problem

Error Codes

- 620** TGP specified incorrect I/O port.
Specify trigger input for the Ext Trig In port, or trigger output for the Ext Trig Out port by the TGP command. Refer to “TGP” command in Programming Guide.
- 621** Specify trigger input port for PAX/WSX.
No trigger input port was specified for the PAX or WSX command. Specify the trigger input port, or set the port as the trigger input port. Refer to “TGP” command in Programming Guide to set trigger port.
- 622** Specify trigger output port for OSX.
No trigger output port was specified for the OSX command. Specify the trigger output port, or set the port as the trigger output port. Refer to “TGP” command in Programming Guide to set trigger port.
- 630** Incorrect polarity of search step value.
For the linear search measurement. The step value must be positive if start<stop, or negative if start>stop.
- 631** Number of search steps must be 1001 or less.
For the linear search measurement. The number of search steps between start and stop must be 1001 or less. This means the |step| value must be |stop-start|/1001 or more.
- 632** Search measurement was aborted.
Search measurement was aborted by the automatic abort function.
- 640** Search limits must be range/20000 or more.
For the binary search measurement. The limit value for the search target must be *range*/20000 or more. where *range* means the measurement range actually used for the measurement.
- 650** Data format must be ASCII to get time data.
The time stamp function is not available for the binary data output format. To use the time stamp function, set the data output format to ASCII.
- 655** Cannot connect/disconnect series resistor.
The series resistor status cannot be changed in the high voltage state. Set the output voltage or the voltage compliance to ± 42 V or less to connect or disconnect the series resistor.

- 656** Series resistor must be OFF for 1 A range.
The series resistor cannot be set to ON for the measurement channels or the output channels that use 1 A range.
- 657** Series resistor cannot be used with ASU.
The series resistor is not available for the channel connected to the Atto Sense and Switch Unit (ASU).
- 670** Specified channel does not have ASU.
Specify the module that can be used with the ASU.

Self-test/Calibration Error

When the Agilent E5260/E5270 fails the self-test or self-calibration, the Agilent E5260/E5270 returns the following error code and error message.

In the error code, N indicates the slot number. If the module is installed in slot 1, and it fails the function test, the error code will be 1760.

700	CPU failed NVRAM read/write test.
701	CPU failed FPGA read/write test.
702	CPU failed H-RESOLN ADC end signal test.
703	CPU failed H-RESOLN ADC start signal test.
704	CPU failed emergency status signal test.
705	CPU failed SRQ status signal test.
706	CPU failed high voltage status signal test.
707	CPU failed low voltage status signal test.
708	CPU failed DAC settling status signal test.
709	CPU failed measure ready status signal test.
710	CPU failed set ready status signal test.
711	CPU failed measure end status signal test.
712	CPU failed measure trigger signal test.
713	CPU failed pulse trigger signal test.
714	CPU failed abort trigger signal test.
715	CPU failed DAC set trigger signal test.
716	CPU failed LCD read/write test.
720	H-RESOLN ADC is not installed.
721	H-RESOLN ADC failed ROM/RAM test.
722	H-RESOLN ADC failed B-COM offset DAC test.
723	H-RESOLN ADC failed sampling ADC test.
724	H-RESOLN ADC failed integrating ADC test.
725	H-RESOLN ADC failed bus function test.
740	GNDU failed calibration.

N760	SMU failed function test.
N761	SMU failed VF/VM function test.
N762	SMU failed IF/IM function test.
N763	SMU failed loop status test.
N764	SMU failed temperature sensor test.
N765	SMU failed CMR amplifier calibration.
N766	SMU failed CMR amplifier adjustment.
N767	SMU failed CMR 100 V range full output test.
N768	SMU failed VF/VM calibration.
N769	SMU failed VM offset calibration.
N770	SMU failed VM gain calibration.
N771	SMU failed VF offset calibration.
N772	SMU failed VF gain calibration.
N773	SMU failed VF gain calibration at 20 V range.
N774	SMU failed VF filter offset calibration.
N775	SMU failed H-SPEED ADC self-calibration.
N776	SMU failed H-SPEED ADC VM offset calibration.
N777	SMU failed H-SPEED ADC VM gain calibration.
N778	SMU failed IF/IM calibration.
N779	SMU failed calibration bus test.
N780	SMU failed IM offset calibration.
N781	SMU failed IM gain calibration.
N782	SMU failed IF offset calibration.
N783	SMU failed IF gain calibration.
N784	SMU failed IDAC filter offset calibration.
N785	SMU failed oscillation detector test.
N786	SMU failed I bias test.
N787	SMU failed common mode rejection test.

If You Have a Problem

Error Codes

N789	SMU failed high voltage detector test.
N790	SMU failed zero voltage detector test.
N791	SMU failed V hold test.
N792	SMU failed V switch test.