

# TM2I Radio- telemetry System

USER MANUAL

for Datapaq®  
Tracker Systems

*with*

**insight**  
software

Issue 2a



**DATA PAQ®**

Fluke Process Instruments

# TM21 Radio-telemetry System

for Datapaq® Tracker Systems with **insight**  
software

# User Manual

Issue 2a



*Datapaq is the world's leading manufacturer of process temperature-monitoring instrumentation. The company maintains this leadership by continual development of its advanced, easy-to-use Tracker systems.*

## **Europe & Asia**

Datapaq Ltd.  
Lothbury House, Cambridge Technopark  
Newmarket Road  
Cambridge CB5 8PB  
United Kingdom  
Tel. +44-(0)1223-652400  
Fax +44-(0)1223-652401  
Email [sales@datapaq.co.uk](mailto:sales@datapaq.co.uk)  
[www.datapaq.com](http://www.datapaq.com)

## **North & South America**

Datapaq, Inc.  
3 Corporate Park Dr., Unit 1  
Derry  
NH 03038  
USA  
Tel. +1-603-537-2680  
Fax +1-603-537-2685  
Email [sales@datapaq.com](mailto:sales@datapaq.com)  
[www.datapaq.com](http://www.datapaq.com)

# SAFETY WARNINGS

For safe use of Datapaq equipment, always:

- Take care to follow its supplied instructions.
- Observe any warning signs shown on the equipment itself.



Indicates **potential hazard**.

On Datapaq equipment this normally warns of high temperature, but where you see the symbol you should consult the manual for further explanation.



Warns of **high temperatures**.

Where this symbol appears on Datapaq equipment, the surface of the equipment may be excessively hot (or excessively cold) and may thus cause skin burns.

© Datapaq Ltd., Cambridge, UK 2013

All rights reserved

Datapaq Ltd. makes no representations or warranties of any kind whatsoever with respect to the contents hereof and specifically disclaims any implied warranties of merchantability or fitness for any particular purpose. Datapaq Ltd. shall not be liable for errors contained herein or for incidental or consequential damages in connection with the furnishing, performance or use of the Datapaq software, associated hardware or this material.

Datapaq Ltd. reserves the right to revise this publication from time to time and to make changes to the content hereof without obligation to notify any person of such revisions or changes.

Datapaq, the Datapaq logo and Oven Tracker are registered trademarks of Datapaq. Microsoft and Windows are registered trademarks of Microsoft Corporation.

Manual set in 10 pt Gill Sans.

User manuals are available in other languages;  
contact Datapaq for details.

The following product types

TM21 Transmitter and Receiver  
manufactured by Datapaq Ltd.,  
Lothbury House, Cambridge CB5 8PB, UK  
comply with the requirements of regional  
directives as follows.

---

#### European Union

*Directive 2004/108/EC* –  
Electromagnetic compatibility (EMC) –  
electrical equipment for measurement, control  
and laboratory use



EN 61326-1:2006 – Group I, Class B equipment  
– Emissions section only

EN 61326-1:2006 – Industrial Location  
Immunity – Immunity section only. (For cables  
up to 30 m in length, a surge test is required  
only on the mains power supply, not on the  
cable; Performance Criterion A is achieved. For  
cables longer than 30 m, the Long Signal 1-kV  
Line–Earth Surge test is applied, IEC 61000-4-  
5; Performance Criterion C is achieved.)

*Directive 99/5/EC* – Radio and telecommunication  
terminal equipment (RTTE)

EN 300 220-1:2000. The declaration of con-  
formity may be consulted at the address above.

*Directive 2006/95/EC* – Low-voltage equipment  
EN 61010-1:2001. If the equipment is used in a  
manner not specified in this manual, the  
protection provided by the equipment may be  
impaired.

*Directive 2002/95/EC* – Restriction of the use of  
certain hazardous substances in electrical and  
electronic equipment (RoHS)

Datapaq temperature-monitoring equipment is  
exempt from the directive under EEE Category  
9 Monitoring and Control Instruments. This  
Datapaq product nevertheless uses RoHS-  
compliant components and manufacturing  
processes.

---

#### Federal Communications Commission, USA

Electromagnetic Compatibility Directive for  
digital devices

CFR47:2007 Class A – Code of Federal  
Regulations: Part 15 Subpart B, Radio

Frequency Devices, Unintentional radiators  
CFR 47 Part 90: Private Land Mobile Radio  
Services

This equipment contains Transceiver Module FCC  
ID: YEETM21.

This device complies with part 15 of the FCC  
Rules. Operation is subject to the following two  
conditions: (1) This device may not cause harmful  
interference, and (2) this device must accept any  
interference, including interference that may  
cause undesired operation.

FCC 15.21 – Changes or modifications to this  
equipment, not expressly approved by Datapaq,  
could void the user's authority to operate the  
equipment.

FCC 15.105 – Note: This equipment has been  
tested and found to comply with the limits for a  
Class A digital device, pursuant to part 15 of the  
FCC Rules. These limits are designed to provide  
reasonable protection against harmful  
interference when the equipment is operated in a  
commercial environment. This equipment  
generates, uses, and can radiate radio frequency  
energy and, if not installed and used in  
accordance with the instruction manual, may  
cause harmful interference to radio  
communications. Operation of this equipment in  
a residential area is likely to cause harmful  
interference in which case the user will be  
required to correct the interference at his own  
expense.

---

#### Industry Canada

This Class A digital apparatus complies with  
Canadian ICES-003.

RSS-119 Issue 9: Land Mobile and Fixed Radio  
Transmitters and Receivers Operating in the  
Frequency Range 27.41–960 MHz

This equipment contains Module IC ID: 9012A-  
TM21.

The abbreviation, IC, before the registration  
number signifies that registration was performed  
based on a Declaration of Conformity indicating  
that Industry Canada technical specifications  
were met. It does not imply that Industry Canada  
approved the equipment.



# CONTENTS

## **7 Introduction**

## **9 Hardware Specifications**

**9 Transmitter**

**10 Primary Receiver**

**11 Secondary Receiver**

## **13 Setting Up the System**

**13 Setting Up Receivers**

**17 Establishing Connection with Insight**

**17 Changing the System's Frequency**

**18 Setting Up the Transmitter Antenna**

## **19 Setup and Procedures in Specific Industries**

**19 Furnace Industry**

**20 Ceramics Industry**

**24 Oven Industry**

**25 Food Industry**

**27 Electronics Assembly Industry**

**27 Datapaq Service Department**

## **29 Running a Temperature Profile**

**29 Resetting the Logger and Starting the Run**

**33 Real-time Data Collection**

**36 Recovering the Logger and Downloading Data**

**38 Using Multiple Loggers**

# Introduction

The TM2I radio-telemetry system has been specifically developed for remote real-time monitoring of heat-treatment processes in harsh industrial environments. It provides a wireless communication link from a Datapaq® data logger inside the heat-treatment process to a PC running Datapaq Insight™ analysis software. The user can then see temperature data from their product in real time as the product passes through the process, and thus watch the whole temperature profile of the process developing in real time. This has significant benefits in many long-duration processes as well as in those semi-batch processes where, once a given time at temperature has been achieved at all locations, the product can be immediately moved on to the next stage of the process.

The TM2I system features:

- Support for multiple loggers within one process transmitting data simultaneously, thus enabling data from a large number of thermocouple channels to be gathered.
- Support for multiple secondary receivers via a single primary receiver connected to the PC's USB port, ensuring good data reception even from long kilns and other processes where a single receiver would have limited coverage. Insight displays information about individual receivers' status and signal strength.
- Ability to configure receivers, with optional automatic choice of radio-frequency to minimize interference.
- Automatic setting of transmitter and receiver(s) to same frequency.
- Multiple transmission of individual data-packets to increase security of data transfer.

The procedures for performing non-telemetry profile runs, and the use of hardwired telemetry, are covered in your logger's dedicated *User Manual* and in Insight's online Help system. The present manual focuses on the process of creating temperature profiles with radio telemetry using the TM2I system, and should be used in conjunction with the logger's *User Manual* in order to cover such aspects as basic logger operation, batteries, and the process of establishing communication between the logger and the Insight software.

You may also need to refer to the *User Manual* or other documentation specific to the Tracker system and/or other Datapaq equipment in use.



# Hardware Specifications

The basic Tracker system hardware comprises:

- Data logger (including communications lead and charger).
- Thermal barrier and thermocouple probes.

Use of these is covered by the relevant *User Manuals* supplied with your system.

Additional equipment for the TM21 radio-telemetry system comprises:

- Transmitter (built into the logger).
- Application-specific transmitter antenna.
- Primary receiver with power-supply unit and antenna.
- Optional secondary receivers.
- Antenna for each secondary receiver.
- Mounting brackets and stands for receivers and antennas, as required.
- Connection cables, as required.

## Transmitter

The TM21 transmitter is a factory-fitted option, internal to the data logger.

<b>Transmitter model</b>	TXI40I
<b>Suitable antenna</b>	Varies with application (see p. 19).
<b>Logger types</b>	MultiPaq21, Q18, Tpaq21
<b>Frequency range</b>	Australia, Brazil, China, Europe, Indonesia, New Zealand, Russia, Thailand, United Arab Emirates 434.065–434.740 MHz Japan 429.275–429.725 MHz Korea 447.8625–447.9750 MHz Mexico 463.7625–463.9875 MHz N America 463.525–463.975 MHz Taiwan 429.8125–429.9250 MHz Rest of the world: contact Datapaq.
<b>Operating temperature</b>	0–110°C/32–230°F
<b>Transmission range</b>	200 m/656 ft in 'open field' conditions.
<b>Max. number of transmitters per system</b>	6
<b>Sample interval</b>	Minimum 1 s, with no interleaving. Minimum value increases with increasing number of interleaving transmissions.
<b>Max. number of interleaving transmissions</b>	10 (see p. 31).
<b>Max. transmitting power</b>	10 mW

# Primary Receiver

<b>Part number</b>	Europe RX4200 – USA RX4100 – Rest of world RX4000
<b>Dimensions (L × W × H)</b>	139 × 98 × 44 mm/5.5 × 3.9 × 1.7 in. (overall, including sockets and brackets).
<b>Suitable antenna</b>	<i>Standard:</i> helical-coil ('whip' antenna), RX1011 (N America), RX1010 (rest of the world). <i>Optional:</i> unity-gain end-feed, RX1024 (N America), RX1023 (rest of the world).
<b>Frequency range</b>	To match transmitter (p. 9).
<b>Communications to PC</b>	USB
<b>Operating temperature</b>	0–50°C/32–122°F
<b>Status display</b>	2-line 16-character LCD + 1 red power LED.
<b>Power supply</b>	CH0070B power-supply unit: input 90–264 V AC, 50–60 Hz, 400 mA.



*TM21 primary receiver: helical-coil ('whip') antenna attached on the upper side of the unit, USB connection cable on the lower left, and an RS485 terminator in place in the secondary-receiver socket on the lower right.*



*TM2I secondary receiver (above): antenna socket is on upper side of the unit, two secondary-receiver/terminator sockets on the lower side (either of the secondary-receiver sockets can be used for the 'in' or for the 'out' cable).*

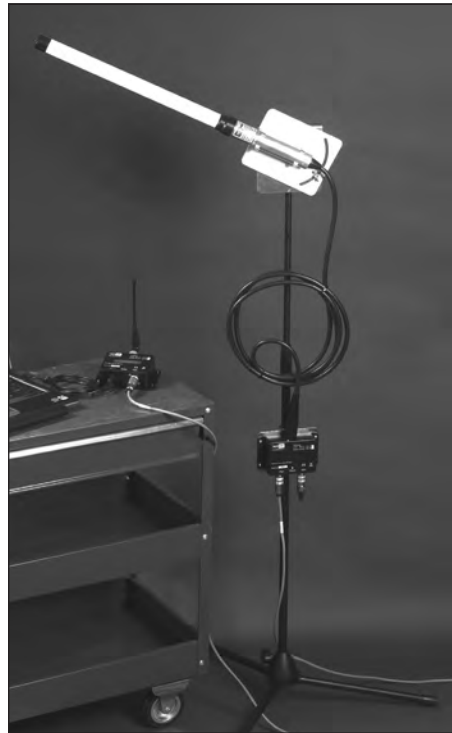

*Unity-gain end-feed antenna (right), with secondary receiver mounted on the antenna stand.*

## Secondary Receiver

<b>Part number</b>	Europe RX4201 – USA RX4101 – Rest of world RX4001
<b>Dimensions (L × W × H)</b>	139 × 98 × 44 mm/5.5 × 3.9 × 1.7 in. (overall, including sockets and brackets).
<b>Suitable antenna</b>	<i>Standard:</i> unity-gain end-feed, RX1024 (N America), RX1023 (rest of the world). <i>Optional:</i> helical-coil ('whip' antenna), RX1011 (N America), RX1010 (rest of the world).
<b>Frequency range</b>	To match transmitter (p. 9).
<b>Connection</b>	To primary receiver and other secondary receivers by RS485 cable.
<b>Maximum no. of secondary receivers in one system</b>	6 (depending on cable lengths).
<b>Operating Temperature</b>	0–50°C/32–122°F
<b>Status display</b>	1 green LED (on when powered up, flashes off when signal received).
<b>Power supply</b>	Via primary receiver.



# Setting Up the System

Basic setup of the TM2I system is similar for all applications, but special considerations apply to its use in different industries, and these are also described (p. 19).

The TM2I system permits simultaneous use of single or multiple loggers (see p. 38) which transmit data to single or multiple radio receivers and transfer it to the PC for recording and analysis by the system's Insight software. The whole system uses a single selectable radio frequency making use of on-air collision avoidance to prevent interference between multiple transmitters monitoring a single process.

As with all radio-frequency systems, the correct setup and siting of antennas is critical to obtaining good reception.

The easiest sequence of operations to adopt when setting up a system for the first time is typically as follows.

1. Set up the system's receiver(s).
2. Establish Insight's connection to the receiver(s) and initiate the search for a clear frequency – and meanwhile . . .
3. Organize the logger, probes, thermal barrier and transmitter antenna.
4. Set or change the system's radio frequency.
5. After this, you can go on to reset the logger(s) and start the profile run.

## Setting Up Receivers

The TM2I system can be used with one or more radio receivers. The use of **multiple radio receivers** is of value chiefly in applications where the secure transmission and reception of radio-telemetry data requires receivers to be sited at various widely separated points to pick up data from a logger moving through the heat-treatment process.

A (single) **primary receiver** is attached to a PC running Insight software. If multiple receivers are being used, additional **secondary receivers** are daisy-chained to the primary receiver using an RS485 digital communications link.

Data received by Insight from multiple radio receivers is displayed and analyzed just as if only a single receiver was in use. However, while a telemetry run is in progress you can use Insight's **Real Time Tool dialog** to obtain confirmation in real time of the data being received by individual receivers (click  on the toolbar, or select View > Real Time Tool).

## Setting Up a Single Receiver

1. Start by connecting the primary receiver's USB cable to any available port on the PC.
2. Plug an RS485 terminator into the secondary-receiver socket on the lower side of the primary receiver.
3. Plug the receiver's power-supply unit into the electricity supply, connect it to the receiver, and switch on the power; the receiver's red power LED comes on. If the PC is also powered on, the receiver's display (see p. 32) should show 'PC OK' to indicate a valid connection to the PC (Insight does not need to be running); if there is no connection, or if the PC is powered down, 'PC XX' will show.
4. Connect the antenna to the type-N coaxial socket on upper side of the receiver (p. 10).

*Ensure that all cables are arranged so that no strain is placed on them and that there is no chance of them become disconnected during a profile run.*

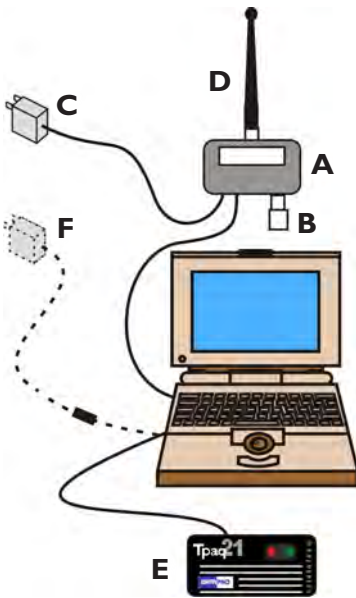

The setup for a basic TM21 radio-telemetry system with a **single (primary) receiver** (A); it has a terminator (B) in place and a power-supply unit (C) attached, and either a whip antenna (D) or a remote antenna may be used. The logger (E) is shown attached, for either reset or download; optionally, the logger's charger (F) can be attached at this time. Such a system may be suitable for, e.g., a batch furnace where it is possible to monitor the process from a position near the furnace.

The **receiver** displays useful status information (p. 32), so it is helpful to place it where the display can be readily seen. A variety of receiver and antenna mounting kits is available from Datapaq, e.g. for fixed installation attached to vertical surfaces.



*Correct fitting of unity-gain end-feed antenna in the rotating clamp of its antenna stand.*

**Choice of antenna** depends on the environment and on the strength of the signal that can be received from the transmitter when it is within the process being monitored. If a remote antenna (p. 11) is used (instead of the whip antenna mounted directly on the receiver), it should be sited where the received signal is strongest. This will usually be near the process chamber, but the location can be optimized when the first profile run is carried out.

**Cable length** from receiver to antenna should not be greater than 20 m. If a greater distance is required, it is advisable to incorporate a secondary receiver attached by cable (see below) and attach the antenna to that, as this arrangement will result in substantially better reception.

### **Setting Up Multiple Receivers**

1. Connect the primary receiver to the PC and to its antenna, as described above – but do not connect a terminator to it.
2. Connect the primary receiver to its power-supply unit, but **do not switch on the power** at this stage.
3. Choose a length of RS485 cable to run between the primary receiver and the first secondary receiver. Take into account the layout of the process's oven/furnace/kiln in relation to a suitable location for the PC.
4. Connect one end of the cable to the socket on the lower side of the primary receiver (p. 10), and the other end to one of the sockets on the lower side of the secondary receiver.

*Either of the sockets on the lower side of the secondary receiver can be used for the 'in' or for the 'out' cable.*

5. If further secondary receivers are used, fit RS485 connection cables to connect the receivers together in a chain.
6. Fit a terminator to the free socket of last receiver in the chain.
7. Switch on power to the primary receiver. If the PC is powered on, the primary receiver's display should show 'PC OK' to indicate a valid connection to the PC (Insight does not need to be running). The primary receiver's display should also register that each of the secondary receivers is connected (see p. 32 for details of the display). If this is not the case, check all connections and retry.
8. Connect an antenna to each receiver. Receiver antennas can either be mounted on Datapaq height-adjustable stands (p. 11) or attached to a suitable available surface. In either case, antennas should be located at least 1 m away from any parallel conductive surface, e.g. metal-clad walls, steel posts, large pipes. The location and orientation (vertical or horizontal) can be optimized when the first profile run is carried out.

See above for choice of antennas and maximum length of antenna cables.

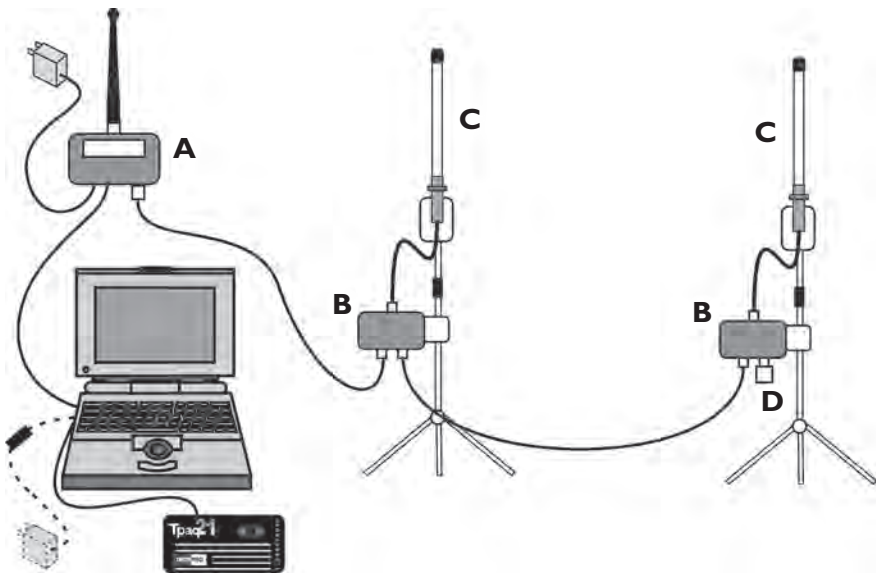

The setup for a TM21 radio-telemetry system with **multiple receivers**: primary receiver (A) with whip antenna, and two secondary receivers (B) attached to unity-gain end-feed antennas (C). Further secondary receivers may be added. The receiver at the end of the chain is fitted with a terminator (D). Such a system may be suitable for, e.g., a long continuous furnace.

*Rarely, cables between receivers over 30 m long may be subject to disruption of communication due to strong power surges (e.g. from lightning). This is rectified by powering the receivers off and on; communications should then resume and Insight will continue to log incoming data from that point onwards.*

## Establishing Connection with Insight

If Insight has not previously been set up for use with radio-telemetry receivers, or if the setup has been changed, it is necessary to inform Insight of the receivers attached and to confirm correct connection as follows.

1. Ensure that the primary receiver and its power-supply unit, secondary receivers (if used), antennas and PC are connected as detailed above, and that the primary receiver's power is switched on.
2. In Insight, open the **Radio Receivers dialog** (click  on the toolbar, or select View > Radio Receivers).
3. In the dialog, click Detect to make Insight find the receivers, and to display information about them.

The dialog then shows:

- The radio frequency currently in use.
- The serial number of each receiver connected.

Where two or more secondary receivers are connected, their sequence in the dialog will not necessarily be the same as that in which they are connected. If you wish, you may correct this: click on the image of a receiver and drag it to the correct position.

If a receiver is not detected initially, due to a connection or power problem, a warning is displayed on the icon for that receiver. If preferred, you may remove that receiver's icon from the display: right-click on the icon and select 'Remove'.

Close the dialog to proceed.

## Changing the System's Frequency

The TM2I system is supplied with transmitter(s) and receiver(s) configured so that they operate on the same radio frequency and can thus communicate. The system's operating frequency can however be changed, if thought necessary, by using the Insight software:

1. Ensure all (primary and secondary) receivers are connected, as detailed above.
2. In Insight, open the **Radio Receivers dialog** (click  on the toolbar, or select View > Radio Receivers).

3. In the dialog, click 'Radio Frequency Wizard' and follow the on-screen instructions.

You may select a specific frequency, or Insight will search for suitable frequencies and rank them according to their susceptibility to external interference.

When the logger is reset to receive fresh data (p. 29), it is automatically instructed to use the same transmitter frequency as that set for the receivers. If multiple loggers are used (see p. 38), they all use the same transmitter frequency.

*If you already know the transmitter frequency you wish to use, you may select it as part of resetting the logger (see p. 31).*

## Setting Up the Transmitter Antenna

Datapaq radio-transmitter antennas are designed specifically to resist the temperature environment in which they operate and to match the operational frequency of the transmitter. Failure to use the correct antenna may result in degraded radio performance.

The orientation of the antenna (e.g. horizontal or vertical) is not important, but **the active portion of the antenna should be kept straight**. Coiling the antenna will reduce the transmitted power and degrade performance of the system.

- For antennas which incorporate a ground-plane base-plate (TX2020 and similar), the active portion of the antenna is the flexible section that protrudes from the base-plate.
- For antennas used in the furnace industry (typically the TX2040), the active portion is the entire length of the antenna that is visible outside the closed thermal barrier.

See also p. 19 for setup with furnace applications.

*Whenever possible, **position the transmitter antenna so that it is not close to any metal surfaces which lie parallel with the plane of the antenna**; metal surfaces which run at right angles to the antenna do not present a problem.*

If the connection-cable section of a transmitter antenna becomes damaged or cut, the whole antenna should be replaced. It is not recommended to re-terminate or repair the cable as special tools are required to ensure that a good matched-impedance connection is achieved.

# Setup and Procedures in Specific Industries

Each individual installation of the TM2I system will require a degree of experimentation in establishing a good working setup. The following guidelines are relevant to applications in specific industries.

## Furnace Industry

*If carrying out a **temperature uniformity survey** of a furnace using telemetry with **Insight Furnace Surveying** software, see the *Furnace Surveying User Manual*.*

### Transmitter Antenna Setup

Two types of antenna are available for furnace systems:

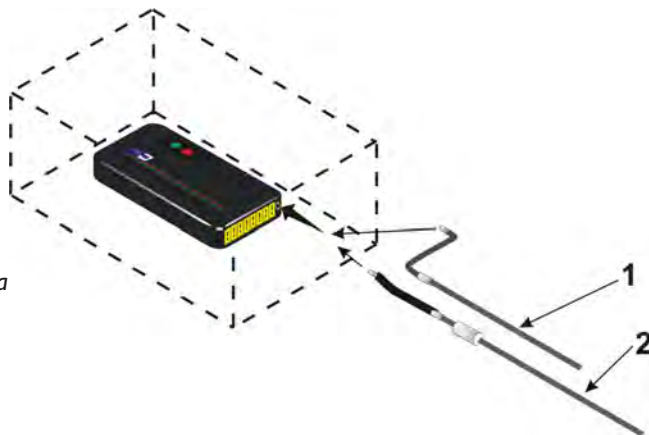

Attachment of antenna types for use with furnace systems. The logger is shown within a thermal barrier (dashed outline).

- 1: TX2040A Furnace transmitter antenna for general applications.
- 2: TX2051A Furnace transmitter antenna for use **only** in low-height-quench thermal barriers (TB4065, TB4072, TB4080, TB4086, TB4101, TB4120, TB4189, TB4196, TB4239, TB4270).

If using the TX2040A antenna, it is important to ensure that the antenna runs across the thermocouple plugs of the logger before turning 90° and exiting through the thermal barrier.

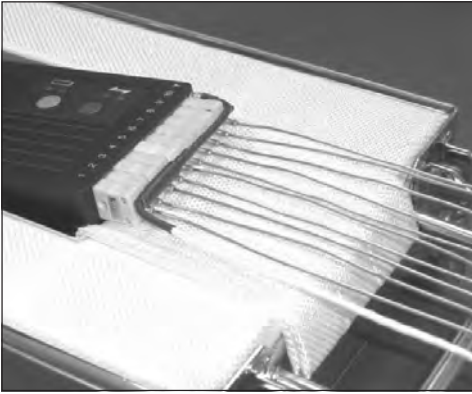

*Trpaq21 logger with TX2040A antenna correctly routed across thermocouple plugs.*

*Ensure that the covering on the transmitter antenna remains intact and that no part of it comes into contact with anything metallic, as this will seriously reduce signal power.*

## **Receiver Antenna Setup**

Position the receiver antenna carefully to maximize reception. Tests have shown that it is normally best for the receiver antenna to be in the same plane as the transmitter antenna (usually horizontal), and the Datapaq antenna stand (p. 11) allows the antenna to be oriented to achieve this.

If your furnace has glass viewing portals (usually in vacuum applications) or cable exits, start by placing the antenna near these as they are good areas for the signal to escape. If multiple receivers are used, it is usually effective to position antennas at the entrance and exit of the furnace.

## **Ceramics Industry**

### **Transmitter Antenna Setup**

Two types of antenna are available, depending on whether it is to be plugged into the front or rear of the thermal barrier.

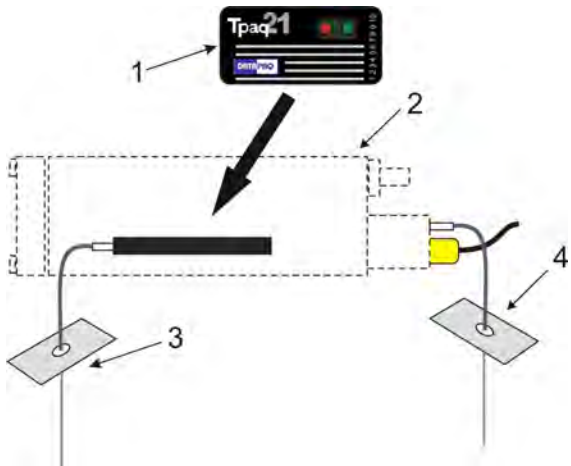

Antenna types for use with a typical kiln thermal barrier.

- 1: Data logger.
- 2: Kiln thermal barrier.
- 3: Transmitter antenna TX2020A (1 m/3 ft), TX2022A (2 m/6 ft), TX2023A (4 m/13 ft), for use when the front of the barrier faces the operator during setup.
- 4: Transmitter antenna TX2021A (1 m/3 ft), TX2024A (2 m/6 ft), TX2025A (4 m/13 ft), for use when the rear of the barrier faces the operator during setup.

*If using the antenna that plugs into the rear of the thermal barrier, ensure that the barrier telemetry wire is plugged into the logger.*

Both types of antenna have a ground-plane plate which must be securely attached to the underside of the kiln car: use a G-clamp to fix to one of the car's I-beams, as close as possible to the sand-seal at the side of the car (without fouling).

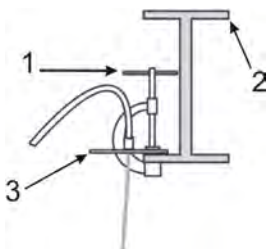

*Attachment of transmitter antenna under a kiln car.*

- 1: G-clamp.
- 2: Kiln car's steel I-beam in section.
- 3: Ground-plane plate.

*It is vital that:*

- the ground-plane plate is clamped to the kiln car, and
- the antenna hangs vertically.

## Receiver Antenna Setup

Typically, the primary receiver and PC will be located in the kiln office, well away from the kiln, and connected to the first secondary receiver by cable (see p. 15).

The recommended **maximum spacing between secondary antennas** for brick-built and steel-clad kilns is as follows.

	Kiln Length	No. of Antennas	Maximum Spacing
Brick-built kilns	< 120 m/394 ft	3	40 m/131 ft
	120–150 m/394–492 ft	4	40 m/131 ft
	150–200 m/492–656 ft	5	40 m/131 ft
Steel-clad kilns	< 90 m/295 ft	3	30 m/98 ft
	90–120 m/295–394 ft	4	30 m/98 ft
	120–150 m/394–492 ft	5	30 m/98 ft
	150–180 m/492–591 ft	6	30 m/98 ft

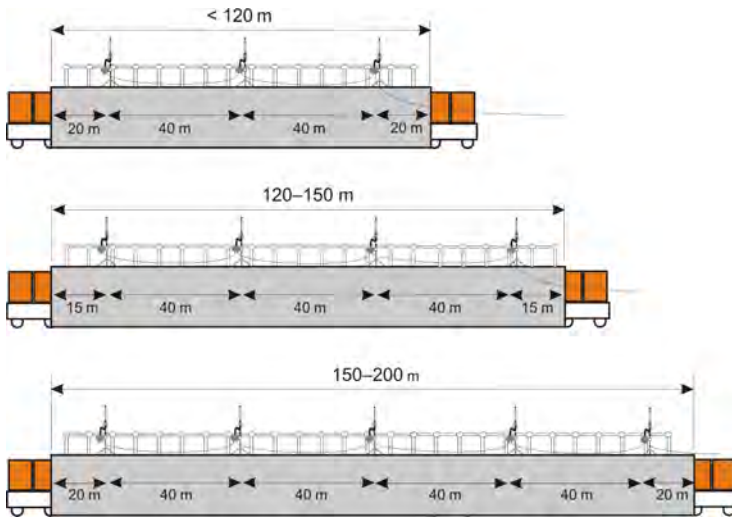

Recommended numbers of antennas, and antenna spacing, for **brick-built kilns** of different lengths.

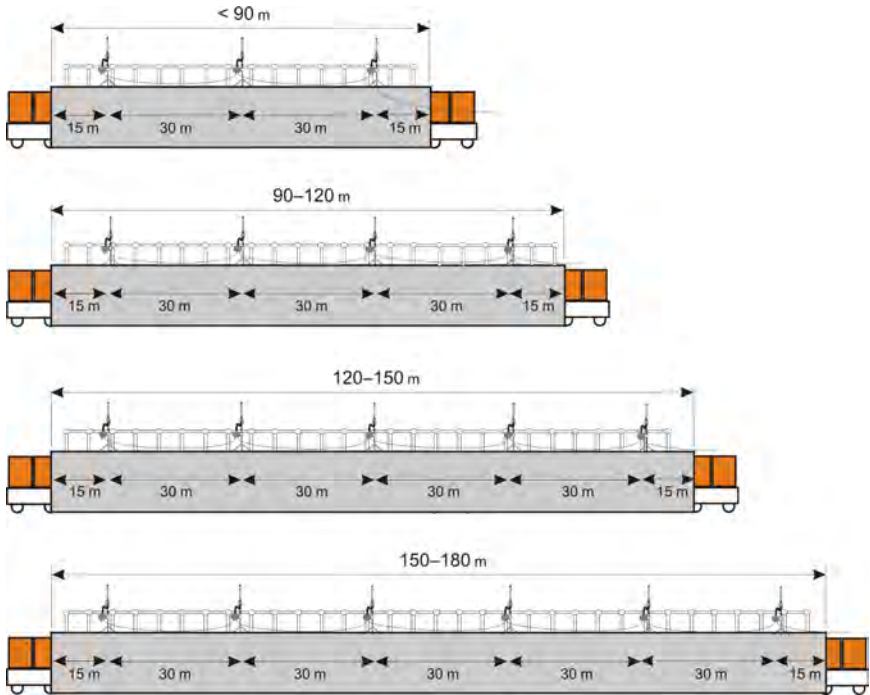

*Recommended numbers of antennas, and antenna spacing, for steel-clad kilns of different lengths.*

Transmitter and receiver antennas should be in the same plane (normally both vertical), with the receiver antennas as close as possible to being directly above the transmitter antenna, i.e. on the same side of the kiln.

Use the receiver antenna's swivel clamp to fasten the antenna to the kiln handrail. The adjacent diagram shows the correct part of the antenna that may be clamped.

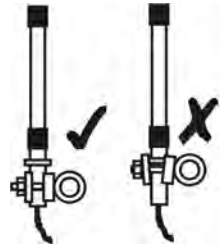

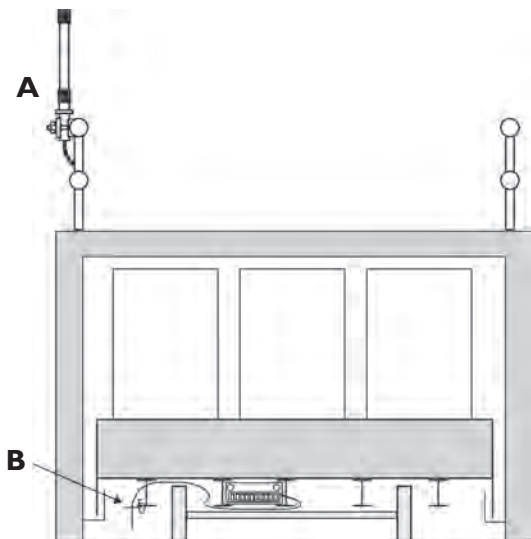

*Vertical section through a kiln and kiln car, showing a typical installation of receiver antennas (A, one shown) on the kiln's handrail, and transmitter antenna (B) below the kiln car. Receiver and transmitter antennas must be on the same side of the kiln.*

## Oven Industry

In most coating applications the process time is relatively short (less than 30 mins), so, in general, monitoring of the process by radio-telemetry provides little benefit. However, in batch or semi-batch applications, radio-telemetry can allow efficient management of the process by monitoring temperature data in real time without the need to have thermocouples trailing out of the oven. Cure times can then be customized to the needs of specific products so that they are removed from the oven at exactly the moment that cure has been identified. Oven heating times are thus reduced, and productivity is improved.

### ***Transmitter Antenna for General Batch Ovens***

For oven applications the preferred transmitter antenna is the TX2040 which plugs directly into the antenna socket (labelled  $\Upsilon$ ) of the Tpaq21 logger. Within the process, the antenna should be positioned so that it does not touch either the product or any of the oven's metalwork. The antenna should be kept straight if space allows (see also p. 19).

### ***RotoPaq System (Rotomolding)***

In rotomolding applications, in which the mold rotates during the process, it is essential that the system is secured to the mold to minimize vibration of the logger and of the transmitter antenna, and to prevent the system falling off. Thus, if using the TB5000-RP or TB5016-RP thermal barriers, they should be

secured using their mounting brackets. Ensure that the system is positioned so that the antenna does not hit any part of the machine during rotation.

Choose the transmitter antenna as follows.

Thermal Barrier	Transmitter Antenna
TB5000-RP	TX2040
TB5016-RP	TX2091
TB4215 *	TX2080

\* See *Oven Tracker® TB4215 RotoPaq Thermal Barrier User Guide* supplied with the barrier.

When using the waterproof **TB5016-RP thermal barrier**, the TX2091 antenna exits the barrier through the barrier's available exit port. The aerial is sealed in the port using a white probe seal (see photographs).

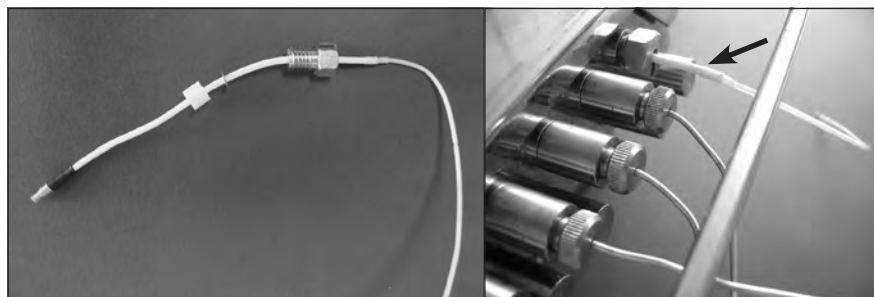

*TX2091 antenna for use with TB5016-RP thermal barrier.*

*Left: antenna showing probe-seal and finger-screw used to create a seal in the barrier's face-plate. Right: antenna (arrowed) fitted in the face-plate.*

## Food Industry

Real-time monitoring by radio-telemetry in the food-processing industry is most beneficial for batch or semi-batch process. An example of this is long-duration cooks in Double D batch or rotating batch ovens followed by blast-chilling in a separate unit: radio-telemetry allows the whole process to be monitored in real time, which would not be possible with trailing thermocouples (hard-wired telemetry) as the product and equipment are constantly rotating and need to be transferred physically from cook to chill.

In many food processes, steam and water/brine are either used as part of the cook/chill process or are produced during the process, and water and water vapor can significantly inhibit radio-frequency transmission. Radio-telemetry is not feasible for any cooking where the system is submerged either in water or oil.

## Transmitter Antenna for MultiPaq21 Logger

Part Number	Description	Operating Temperature	Typical Applications
TX2071A	PTFE flexible coaxial cable with reflector plate	Up to 265°C/ 509°F	Conveyorized and batch oven processes without submersion

*Extreme care should be taken when handling, fitting or positioning the antenna, as the performance of the whole system will deteriorate if it is fitted incorrectly. Any damage to it could make the system inoperable.*

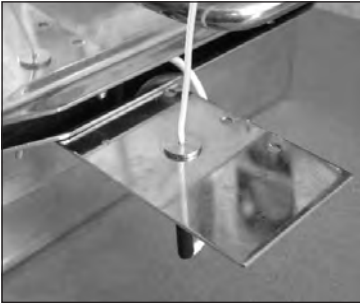

*Transmitting antenna screwed to the thermal barrier's splash guard.*

When used with a non-submersible thermal barrier (TB5009, TB5010, TB5011), the antenna's reflector plate is screwed to the barrier's splash guard. With a submersible barrier (TB5815, TB5816), a separate mounting bracket on the side of the barrier is used.

The section of coaxial cable beyond the reflector plate should be kept as perpendicular to the plate as possible.

In installing the transmitter cable and MultiPaq21 logger into the barrier, treat the cable as if it is a thermocouple cable (see

the *Food Tracker® User Manual*) and connect it to the logger's antenna socket next to probe no. 1 on the end of the logger. For submersible barriers, feed the transmitter cable through the appropriate port in the barrier using a white probe seal.

### Receiver Antenna Set-up

The primary receiver is not IP rated against water ingress, so care must be taken to protect it from moisture or other physical damage resulting either from the process itself or from other shop-floor conditions including any regular clean-down practices. Consequently it may be desirable to use a secondary receiver and locate the PC and primary receiver well away from the hazards of the food-processing environment. See p. 15 for details of setup.

# Electronics Assembly Industry

## *Reflow Soldering*

The typical receiver arrangement for use with reflow ovens will consist of a primary receiver only, normally equipped with whip antenna mounted on the receiver. However, if the PC and receiver are not located directly adjacent to the oven, the whip antenna should be replaced by a unity-gain end-feed antenna which can then be located close enough to the oven to guarantee reception.

If a number of reflow ovens is to be monitored using telemetry, it can be valuable to add a **secondary receiver** and antenna next to each oven. This enables data to be received at a single PC from any one of the monitored ovens without the need to repeatedly relocate the receiving antenna.

When the Reflow Tracker® system is placed in the oven, the **transmitter antenna** should be laid horizontally but held above the oven's mesh belt by placing it on PTFE blocks or similar. If the antenna is allowed to lay directly on the belt, signal quality may be significantly reduced.

## *Other Processes*

Radio-telemetry is generally not recommended for use in monitoring of **wave-solder** processes as the minimum sample interval available is 1 s (see p. 9), whereas the wave-solder process should be sampled every 0.05 s to ensure accuracy of measurement of contact time.

Radio-telemetry is not available for use in **vapor-phase soldering** processes.

## Datapaq Service Department

If you cannot resolve your problem, please contact the Service Department at Datapaq (see title page for contact details).



# Running a Temperature Profile

When both hardware and software for the TM2I system have been set up (p. 13 and p. 19), you can proceed to conduct a temperature-profile run.

By following the procedure described here you will use the Logger Reset and Logger Download dialogs to run a temperature profile using radio telemetry. Thus, as the logger gathers data from the product inside the process, this is transmitted directly to the PC by radio transmitter/receiver. The temperature profile can be watched developing as it happens, i.e. in real time.

After the run is completed, the data received by telemetry can be saved as a new file (a 'paqfile'). However, as data is also stored internally in the logger during the run, it may be preferable instead to download the data from logger to PC after the run is finished and to save that as the final paqfile (p. 36). This means there is less chance of the paqfile having missing data points due to losses in transmission.

The TM2I system permits use of **multiple loggers**, so data can then be gathered from a greater number of thermocouple channels than can be achieved with a single logger (see p. 38).

## Resetting the Logger and Starting the Run

Ensure first that:

- The (primary) receiver is connected to the PC via a USB port, and to its power supply (see p. 14).
- If Insight has not previously been set up with radio-telemetry receivers, or if the setup has been changed, open the Radio Receivers dialog to inform Insight of the receivers attached, and to provide confirmation of correct connection (see p. 17).

The data logger needs to be reset, as follows, before it can receive fresh data. (If multiple loggers are used for the run, this process is repeated for each logger.)

The procedure described here uses the Insight software's Logger Reset dialog. If you are less sure of the process, and **if using a single logger** for a profile run, you can instead use the Logger Reset Wizard to guide you, step-by-step, through this stage of running a profile: click  on the Insight toolbar, or select Tools > Wizards from the menu.

If carrying out a **temperature uniformity survey** of a furnace using **Insight Furnace Surveying** software with single or multiple loggers and single or multiple radio receivers, temperature profiles should be run using the software's Temperature Uniformity Survey Wizard, and not as described below.

Depending on the model of your logger, it may not necessary to go through the reset procedure if the previous reset options are to be re-used: see your logger's User Manual.

Ensure that your logger has cooled sufficiently from the previous run. Some models of logger cannot be reset if they are too hot: see your logger's User Manual.

Any data stored in the logger but not yet analyzed must be downloaded before proceeding, as **resetting the logger will permanently erase all data stored in it.**

If the system's **radio frequency** needs to be changed, this can be done either before the logger is reset, by using the Radio Frequency Wizard (see p. 17), or during the reset (see below).

1. If the logger is fitted with a **rechargeable NiMH battery**, ensure it is adequately charged. The logger may be on charge during the reset. See your hardware manual for the charging process.
2. Use the **communications lead** supplied to connect the logger to a free USB or COM (serial) port on the PC (if using multiple loggers, you must use USB).

*To minimize communications problems: a) connect the lead first to the PC and then to the logger; b) if using USB, always use the same USB port – the one which was first used to set up communications.*

The red LED on the logger should flash five times to confirm that the connection between the communications lead and the logger has been made.

3. Open the **Logger Reset dialog** (click  on the Insight toolbar, or press function key F2, or select Logger > Reset from the menu bar) and specify the use of **radio telemetry**.

Using radio telemetry increases the logger's power consumption and will thus tend to shorten the logger battery's operation time. This effect can be minimized by choosing appropriate reset options, as follows:

- **Sample Interval** Longer sample intervals reduce power consumption.

- **Probes Selected** Deselect unused probe channels to prevent transmission of redundant data.
- **Transmissions** (click 'Advanced Telemetry' button) The system's transmitter can make multiple transmissions (**interleaving**), i.e. it sends each reading a number of times in order to increase reception quality. This can overcome momentary interference such as that caused by the switching of large electrical loads, but it consumes more power. Typically, three transmissions is a good compromise for most industrial processes. Using interleaving increases the minimum sample interval which can be achieved (see p. 9).

Select other reset options, including **trigger mode**, and note whether the memory and battery status are adequate for your run (the display of battery status is invalid for lithium batteries).

*If required, the transmitter's radio frequency can be set here (click the 'Advanced Telemetry' button) – though in normal use it is best to let Insight set this automatically, to match the receiver frequency (which is set by using the Radio Frequency Wizard before the logger is reset, see p. 17). For more details of this and other reset options, see Insight's Help system and select Menu Functions > Logger > Reset.*

4. After clicking **OK**, the logger is reset and a message box confirms the sample interval and trigger mode you have set.
5. Disconnect the **communications lead** from the logger.
6. The logger's red and green status LEDs then briefly flash alternately to confirm logger reset; click **OK**.
7. If enabled, the **Select Process** dialog or the **Select Oven, Recipe and Product** dialog then appears in order that you may choose a process, oven, recipe or product file which will be applied to the results as the profile appears on screen during the run. Click 'No Process' or 'Cancel' if you do not want to apply one. (A process file allows you to see the temperature profile in relation to the oven zones as the profile appears on screen during the run. See the Insight software for an introduction to process files: press function key F1, or select Help > Contents from the menu bar, and click the section 'Process Files: Oven, Recipe, Product'.)
8. If **multiple loggers** are used for the run (see p. 38), the sequence above is then repeated for each logger until all are reset.
9. Plug the **thermocouples** into the logger's numbered sockets. If you are using a process or product file, ensure that the probe/socket numbers on the logger correspond to those used to define probe numbers and locations in that file.
10. Ensure the sealing surfaces of the **thermal barrier** are clean and

undamaged. Good barrier seals, including those between the barrier and the thermocouple cables, are essential if the logger is to be protected.





11. If the trigger mode is Start Button, press and hold the logger's **start button** for about 1 second until the green LED starts to flash at the sample interval.
12. Put the logger into the barrier, seal it, and place the logger–barrier assembly into your process together with your instrumented product or test-piece.

For guidance specific to your application, see p. 19 and your system's *User Manual*.

You may specify that a **password** is required when an attempt is made to close Insight while a real-time telemetry run is in progress:  
select *Tools > Options > General*.

## Receiver Status

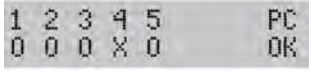
As soon as transmitted data is being received by the primary receiver, its display records the status. Details of the receiver displays are shown below.

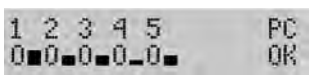
Display	Meaning
	Good USB connection to powered-up PC.
	No USB connection, or PC not powered up.
	Primary receiver (1) and four secondary receivers (2–5) are connected, and communication is established.
	One secondary receiver has become disconnected or communication is not fully established. <i>NB The numbering of secondary receivers in the display is arbitrary and does not reflect their connection sequence, though the numbering will be constant during each powered-up session.</i>
	Data-packet being received by primary receiver.
	After the SIGNAL display when the primary receiver receives a data-packet, this display appears until the next data-packet is received: the height of the bar shown briefly adjacent to each receiver's number represents the signal strength recorded by it.

Display	Meaning
Red LED – <i>primary receiver</i>	LED on when powered up.
Green LED – <i>secondary receiver</i>	LED on when powered up. Flashes off when signal is being received.

## Real-time Data Collection

Once new data starts to be received, it is displayed in Insight's Graph and Analysis Windows, scrolling in real time as new data arrives. You may change the way the data is displayed with the Axes tab of the Graph Options dialog (from the right-click menu, or from the main menu select View > Graph Options): under Telemetry, specify how much of the recently received data is displayed, and whether you wish to see only a certain temperature (y-axis) range, centered on the latest data.

You may **zoom** the display as when viewing a paqfile, except that:

- Double-clicking on the graph (or selecting Real Time Zoom from the View menu or right-click menu) shows only the most recently received portion of the data on the scrolling graph (see above).
- Saved zoom modes are not available.

If the **y-axis** is not set to be centered (see above), the default y-axis zoom changes as more data is received, in order to accommodate all received data.

*To **move the graph** across the viewing area, hold Shift and drag the mouse pointer.*

You may **overlay** one or more **tolerance/ideal curves** or other paqfiles on the graph to compare with the data as it is being received (select View > Overlay).

*If you wish to **open another paqfile** and view it in a separate tab while the logger is in listen mode, i.e. while data is being received and viewed in real time, you must first stop real time mode (see p. 35). You may instead, however, open the other paqfile as an overlay while still in real time mode, as above.*

You may adjust the **oven/furnace/kiln start** position while a real-time run is in progress (select Process > Adjust Oven/Furnace/Kiln Start, or use the right-click menu; see also Insight's Help system or your logger's *User Manual*).

Calculations shown in the **Analysis Window** for the chosen data analysis mode update continuously as new data is received. As for non-real-time runs, calculations are performed only on the currently zoomed area shown on the graph. However, if the graph is scrolling and showing just the most recently

received portion of the results, the analysis calculations will be performed as if on the full zoom view.

## Real Time Tool

While a radio-telemetry run is in progress, you may use the **Real Time Tool dialog** to check the integrity of data-packets as they are received, as well as the status of the logger(s) and the receiver(s) (click  on the toolbar, or select View > Real Time Tool).

The dialog shows:

- The status of **receivers** and **loggers** in use.
- **Real-time confirmation of data** being transmitted and received, and its quality.

Information is transmitted from the logger as **data-packets** (i.e. sets of data from all of the logger's probes at a given instant, determined by the sample interval specified). The TM21 radio-telemetry system can transmit a given data-packet multiple times, interleaving this with other data-packets, thus greatly increasing the security of data transmission (see also p. 31).

Click **Contract** to remove the receivers from the dialog's display, and to reduce logger information to that which concerns packet transmission/reception. **Expand** restores the full display.

## Receivers

The dialog shows icons representing all of the attached receivers, each with their receiver number and serial number. The primary receiver is shown as receiver number 1.



When each receiver receives a data-packet, the signal-strength window within its icon (see left) shows a green bar which lengthens in proportion to the signal strength while the data-packet is being received. A small vertical black bar in the signal-strength window shows the strength of the previous signal received. If no further data is received, the black bar moves to the left.

Where two or more secondary receivers are connected, their sequence in the dialog will not necessarily be the same as that in which they are connected. If you wish, you may correct this: click on the image of a receiver and drag it to the correct position.



If a receiver is not detected initially, due to a connection or power problem, a warning is displayed on the icon for that receiver (see left) until Insight detects it. If preferred, you may remove that receiver's icon from the display: right-click on the icon and select 'Remove'.

## Loggers

The loggers section of the dialog shows a summary of status and data transmission for each logger in use.

**Logger ID** The logger's serial number – highlighted in blue for the logger which sent the last data-packet to be received.

**Battery** Percentage of full charge. For lithium batteries a figure is not shown, but the display will show a warning ⚠ when the battery charge is low.

**Temperature** Temperature of the logger's thermocouple cold junction (logger's internal temperature). A warning ⚠ indicates that the maximum permitted value has been exceeded.

**Frequency** The radio frequency currently being used by the system (see above).

**Packet ID** Identity number of last data-packet received.

**Next Data Due** A countdown, in steps of 1 s, to the time when the next data-packet is expected (according to the sample interval set).

**Data Received** The number of valid data-packets received, as a percentage of the total number of data-packets transmitted so far. The reset button  next to the percentage figure forces this calculation to restart.



**Last Transmission** The scrolling display shows groups of data-packets as they are received. Green packets indicate good data, red packets show invalid data (e.g. with a checksum error).

Larger-than-usual gaps between the groups of packets indicate transmissions not received. The time of receipt of the last transmission is shown below the display. You may choose to have the PC beep as each valid data-packet is received.

## Ending Real-time Data Collection

You may wish to **end data-collection** when the logger is removed from the oven/furnace/kiln – or, by selecting **Logger > Stop Real Time Mode**, you may end or pause it while a telemetry run is still in progress. Data then continues to be collected by the logger, but it is no longer received in real time by Insight (download from the logger after the run is finished to retrieve the full data). The graphical and numerical data received up to that point remain on screen, available for viewing and analysis, and can be saved as a paqfile.

While the logger is still transmitting, you may **resume the collection of transmitted data** (select **Logger > Logger Listen Mode**). After the first few data-packets have been received, the data starts to be displayed in the Graph and Analysis Windows. This second bout (and any subsequent bouts) of data-collection can also be ended and saved as a separate paqfile, as above.

If **Autosave** is enabled (select Tools > Options > General), the data being gathered is automatically saved during a telemetry run. If the PC system fails during the run, the autosaved version of the data is displayed automatically when Insight is next run, and you may then choose to save it as a paqfile.

Although the full data from the profile run should already have been received by Insight, and can thus be saved as described above, it is best practice also to download the data from the logger (see below) and to retain that version as well as the transmitted version of data.

When the run is complete, go on to remove the logger from the furnace.

## Recovering the Logger and Downloading Data

Recover the system from the oven/furnace/kiln as soon as the run is over.

### WARNING

*The logger will be **hot**. Use protective gloves.  
Failure to remove the logger from the hot thermal barrier could damage the logger.  
See your system's User Manual.*

1. Open the **thermal barrier**. Placing it on a cold surface will increase its rate of cooling. (An additional thermal barrier should be purchased if insufficient time is available to allow it to cool between test runs.)
2. Remove the logger from its thermal barrier.
3. If data acquisition has to be stopped manually, press and hold the **stop button** until the red and green status LEDs are on simultaneously. A red LED flashing every 5 s indicates data stored in the logger but not yet downloaded to the PC.
4. Use the **communications lead** supplied to connect the logger to a free USB or COM (serial) port on the PC (if using multiple loggers, you must use USB).

*To minimize communications problems: a) connect the lead first to the PC and then to the logger; b) if using USB, always use the same USB port – the one which was first used to set up communications.*

The red LED on the logger should flash five times to confirm that the connection between the communications lead and the logger has been made.

5. Open the Logger Download dialog (click  on the toolbar, or press function

key F3, or select Logger > Download from the menu bar) and wait while the data is downloaded to the PC.

*If using a single logger for a profile run, you can also download the logger using the **Logger Download Wizard** (click  or select Tools > Wizards).*

*You can set **run alarms** to be triggered during a logger download, to warn you of incomplete data recorded during the profile run (from the menu bar, select Tools > Options > Run Alarms).*

*If you see the message*

**Logger stopped due to going over temperature**

*the data logger's maximum-permitted internal temperature has been exceeded, and it may have suffered damage. The reason for the excessive temperature – which may be the result of process operational problems or the use of an inappropriate thermal barrier – must be resolved before further profile runs take place; contact Datapaq for advice.*

*A warning message will also be shown if the logger has stopped recording data due to a **discharged battery**.*

*In both cases, data recorded up to that point will have been preserved.*

6. If enabled, the **Select Process** dialog or the **Select Oven, Recipe and Product** dialog then appears in order that you may choose a process, oven, recipe or product file which will be applied to the results. Click 'No Process' or 'Cancel' if you do not want to apply one.

*If you will normally not wish to apply a process file to the results, you can opt not to have the Select Process dialog displayed immediately after a download (from the menu bar, select Tools > Options > Process File); a process file may then still be applied subsequently.*

7. The newly downloaded data then appears on screen numerically and graphically. Save the data as a **paqfile**.

The data from your profile run can now be displayed, printed and analyzed as you wish (see Insight's Help system).

If you have not applied a process file, or if the process file you applied did not specify that the **oven/furnace/kiln start** position be adjusted, you may want to adjust that start position now (select Process > Adjust Oven/Furnace/Kiln Start). This can be valuable as it permits different paqfiles, i.e. data from different temperature profile runs, to be compared with each other.

Information about the logger and the data-collection process for the paqfile (including time/date, trigger mode and maximum internal logger temperature)

can be seen in the Paqfile Properties dialog (select File > Properties, or graph right-click menu).

## Multiple Loggers

Using multiple loggers permits data to be gathered from a greater number of thermocouple channels than can be achieved with a single logger.



*To use multiple loggers with hardwired telemetry, all loggers must be connected to the PC via **USB** (not by COM port).*

*When using the **Furnace Surveying** module of Insight, the use of multiple loggers is handled entirely by the Temperature Uniformity Survey Wizard which is available within that module.*

Use the **Logger Reset Wizard** to guide you step-by-step through the whole process of resetting multiple loggers: click  on the Insight toolbar, or select Tools > Wizards (with hardwired telemetry, multiple loggers cannot be reset using the Logger Reset dialog). You must first enable the use of multiple loggers in the Global Options dialog: select Tools > Options > General.

Data from multiple loggers used in a single profile run is stored by default in a single paqfile. The whole of the data contained in that paqfile is then displayed and analyzed just as for a single-logger paqfile.

Insight's floating **logger toolbar** controls the display of data from each logger, and allows data from any one logger to be saved as a separate paqfile. The logger number – shown in the logger toolbar – allows duplicate probe numbers from the multiple loggers to be separately identified in the Analysis Window, in the probe toolbar, and in the probe key to the right of the graph.

The **sort order** of the duplicate probe numbers in the Analysis Window is changed by the  and  buttons.

While a telemetry run is in progress, the **Real Time Tool** dialog gives a summary of status and data transmission for each logger in use: click  on the toolbar, or select View > Real Time Tool; see also Insight's Help system.



## **Europe & Asia**

Datapaq Ltd  
Lothbury House  
Cambridge Technopark  
Newmarket Road  
Cambridge CB5 8PB  
United Kingdom  
Tel. +44-(0)1223-652400  
Fax +44-(0)1223-652401  
sales@datapaq.co.uk

## **North & South America**

Datapaq, Inc.  
3 Corporate Park Dr., Unit 1  
Derry, NH 03038  
USA  
Tel. +1-603-537-2680  
Fax +1-603-537-2685  
sales@datapaq.com

## **China**

Datapaq Ltd  
3rd Floor, Lane 280-6  
Linhong Road  
Shanghai 200335  
China  
Tel. +86(0)21-6128-6200  
Fax +86(0)21-6128-6221  
Fax +86(0)21-6128-6222  
sales@datapaq.com.cn



Fluke Process Instruments