

**Agilent Technologies**  
**Solar Array Simulator**  
**Series E4360**

**Service Guide**



**Agilent Technologies**

## Legal Notices

© Agilent Technologies, Inc. 2008 - 2010

No part of this document may be photocopied, reproduced, or translated to another language without the prior agreement and written consent of Agilent Technologies, Inc. as governed by United States and international copyright laws.

### Warranty

The material contained in this document is provided “as is,” and is subject to being changed, without notice, in future editions. Further, to the maximum extent permitted by applicable law, Agilent disclaims all warranties, either express or implied, with regard to this manual and any information contained herein, including but not limited to the implied warranties of merchantability and fitness for a particular purpose. Agilent shall not be liable for errors or for incidental or consequential damages in connection with the furnishing, use, or performance of this document or of any information contained herein. Should Agilent and the user have a separate written agreement with warranty terms covering the material in this document that conflict with these terms, the warranty terms in the separate agreement shall control.

### Manual Editions

Manual Part Number: E4360-90010  
Fifth Edition, October, 2010  
Printed in Malaysia.

Reprints of this manual containing minor corrections and updates may have the same printing date. Revised editions are identified by a new printing date.

### Waste Electrical and Electronic Equipment (WEEE) Directive 2002/96/EC

This product complies with the WEEE Directive 2002/96/EC marketing requirement. The affixed product label (see below) indicates that you must not discard this electrical/electronic product in domestic household waste.

**Product Category:** With reference to the equipment types in the WEEE directive Annex 1, this product is classified as “Monitoring and Control instrumentation” product.

Do not dispose in domestic household waste.

To return unwanted products, contact our local Agilent office, or see [www.agilent.com/environment/product](http://www.agilent.com/environment/product) for more information.



### Certification

Agilent Technologies certifies that this product met its published specifications at time of shipment from the factory. Agilent Technologies further certifies that its calibration measurements are traceable to the United States National Institute of Standards and Technology, to the extent allowed by the Institute's calibration facility, and to the calibration facilities of other International Standards Organization members.

### Exclusive Remedies

THE REMEDIES PROVIDED HEREIN ARE THE CUSTOMER'S SOLE AND EXCLUSIVE REMEDIES. AGILENT TECHNOLOGIES SHALL NOT BE LIABLE FOR ANY DIRECT, INDIRECT, SPECIAL, INCIDENTAL, OR CONSEQUENTIAL DAMAGES, WHETHER BASED ON CONTRACT, TORT, OR ANY OTHER LEGAL THEORY.

### Assistance

This product comes with the standard product warranty. Warranty options, extended support contacts, product maintenance agreements and customer assistance agreements are also available. Contact your nearest Agilent Technologies Sales and Service office for further information on Agilent Technologies' full line of Support Programs.

### Technologies Licenses

The hardware and or software described in this document are furnished under a license and may be used or copied only in accordance with the terms of such license.

### U.S. Government Restricted Rights

Software and technical data rights granted to the federal government include only those rights customarily provided to end user customers. Agilent provides this customary commercial license in Software and technical data pursuant to FAR 12.211 (Technical Data) and 12.212 (Computer Software) and, for the Department of Defense, DFARS 252.227-7015 (Technical Data – Commercial Items) and DFARS 227.7202-3 (Rights in Commercial Computer Software or Computer Software Documentation).

### Trademarks

Microsoft and Windows are U.S. registered trademarks of Microsoft Corporation.

## Safety Notices

The following general safety precautions must be observed during all phases of operation of this instrument. Failure to comply with these precautions or with specific warnings or instructions elsewhere in this manual violates safety standards of design, manufacture, and intended use of the instrument. Agilent Technologies assumes no liability for the customer's failure to comply with these requirements.

### General

Do not use this product in any manner not specified by the manufacturer. The protective features of this product may be impaired if it is used in a manner not specified in the operation instructions.

### Before Applying Power

Verify that all safety precautions are taken. Make all connections to the unit before applying power. Note the instrument's external markings described under "Safety Symbols"

### Ground the Instrument

This product is a Safety Class 1 instrument (provided with a protective earth terminal). To minimize shock hazard, the instrument chassis and cover must be connected to an electrical ground. The instrument must be connected to the ac power mains through a grounded power cable, with the ground wire firmly connected to an electrical ground (safety ground) at the power outlet. Any interruption of the protective (grounding) conductor or disconnection of the protective earth terminal will cause a potential shock hazard that could result in personal injury.

### Fuses

The instrument contains an internal fuse, which is not customer accessible.

### Do Not Operate in an Explosive Atmosphere

Do not operate the instrument in the presence of flammable gases or fumes.

### Do Not Remove the Instrument Cover

Only qualified, service-trained personnel who are aware of the hazards involved should remove instrument covers. Always disconnect the power cable and any external circuits before removing the instrument cover.

### Do Not Modify the Instrument

Do not install substitute parts or perform any unauthorized modification to the product. Return the product to an Agilent Sales and Service Office for service and repair to ensure that safety features are maintained.

### In Case of Damage

Instruments that appear damaged or defective should be made inoperative and secured against unintended operation until they can be repaired by qualified service personnel.



















#### CAUTION

A **CAUTION** notice denotes a hazard. It calls attention to an operating procedure, practice, or the like that, if not correctly performed or adhered to, could result in damage to the product or loss of important data. Do not proceed beyond a **CAUTION** notice until the indicated conditions are fully understood and met.

#### WARNING

A **WARNING** notice denotes a hazard. It calls attention to an operating procedure, practice, or the like that, if not correctly performed or adhered to, could result in personal injury or death. Do not proceed beyond a **WARNING** notice until the indicated conditions are fully understood and met.

## Safety Symbols

	Direct current
	Alternating current
	Both direct and alternating current
	Three phase alternating current
	Earth (ground) terminal
	Protective earth ground terminal.
	Frame or chassis terminal
	Terminal is at earth potential.
	Neutral conductor on permanently installed equipment
	Line conductor on permanently installed equipment.
	On supply
	Off supply
	Standby supply. Unit is not completely disconnected from ac mains when switch is off
	In position of a bi-stable push switch
	Out position of a bi-stable push switch
	Caution, risk of electric shock
	Caution, hot surface
	Caution, refer to accompanying description

# Contents

<b>1 - Introduction .....</b>	<b>5</b>
Returning an Instrument.....	6
Instrument Identification.....	6
Firmware Upgrade .....	7
<b>2 - Performance Verification.....</b>	<b>9</b>
Verification Description.....	10
Verification Procedure.....	12
Constant Current Tests .....	15
Test Record Forms .....	18
<b>3 - Calibration .....</b>	<b>27</b>
Calibration Description .....	28
Calibration Procedure .....	29
<b>4 - Disassembly .....</b>	<b>33</b>
Electrostatic Discharge (ESD) Precautions.....	34
Disassembly Procedures.....	34
Installing a Redundant Ground for 400 Hz Operation .....	39
<b>5 - Troubleshooting .....</b>	<b>41</b>
Preliminary Checkout.....	42
Overall Troubleshooting .....	43
Front Panel Troubleshooting .....	46
Bias Board Troubleshooting.....	46
Backplane Board Troubleshooting .....	47
Power Module Troubleshooting .....	48
Calibration and Passwords .....	50
Initialization .....	50
<b>6 - Replaceable Parts.....</b>	<b>51</b>
E4360A Mainframe Parts List.....	52
E4360A Mainframe Parts Location Diagram.....	53
E4361A/E4362A Parts List .....	54
E4361A/E4362A Parts Location Diagram .....	54
<b>Appendix A - Error Messages.....</b>	<b>55</b>
Displaying Error Messages .....	56
Error List.....	56

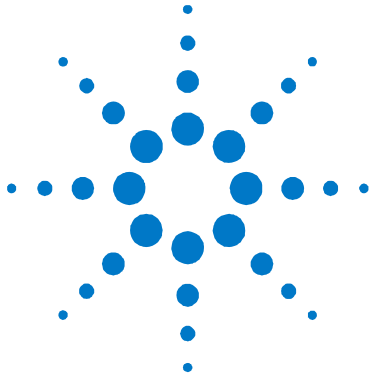

# 1 Introduction

<a href="#">Returning an Instrument</a> .....	6
<a href="#">Instrument Identification</a> .....	6
<a href="#">Firmware Upgrade</a> .....	7

This manual discusses the troubleshooting procedures for the E4360 Series Solar Array Simulator. Troubleshooting procedures are provided to isolate defective assemblies. These procedures do not troubleshoot to the component level.

No procedures are provided for troubleshooting individual modules - other than identifying if a specific module is defective. If you have a defective module, you can return it to Agilent Technologies for repair or replacement. Refer to the following note.

## NOTE

You can contact Agilent Technologies at one of the following telephone numbers for warranty, service, or technical support information.

In the United States: (800) 829-4444

In Europe: 31 20 547 2111

In Japan: 0120-421-345

Or use our Web link for information on contacting Agilent in your country or specific location: [www.agilent.com/find/assist](http://www.agilent.com/find/assist)

Or contact your Agilent Technologies Representative.

The web contains the most up to date version of the manuals. Go to <http://www.agilent.com/find/E4360> to get the latest version of the manuals.

## Returning an Instrument

Before returning your instrument to Agilent Technologies for service or repair, perform the “Preliminary Checkout” procedures in the beginning of chapter 4.

### Warranty Repair

If your instrument fails during the warranty period, Agilent Technologies will replace or repair it free of charge. After your warranty expires, Agilent Technologies will replace or repair it at a competitive price. The standard repair process is “whole unit exchange”. The replacement units are fully refurbished and are shipped with new calibration certificates.

Contact your nearest Agilent Technologies Service Center. They will arrange to have your instrument repaired or replaced.

### Repackaging for Shipment

If the unit is to be shipped to Agilent Technologies for service or repair, be sure to:

- Attach a tag to the unit identifying the owner and indicating the required service or repair. Include the model and serial number.
- Place the unit in its original container with the appropriate packaging material and secure the container with strong tape or metal bands.

If the original shipping container is not available, place your unit in a container that will ensure at least 4 inches of compressible packaging material around all sides for the instrument. Use static-free packaging materials to avoid additional damage to your unit.

*Agilent Technologies suggests that you always insure shipments.*

## Instrument Identification

### Serial Number

Agilent E4360 SAS mainframes are identified by the serial number located on the interface cover.

The serial number consists of a 10-character number (e.g. MY24D00013) located on the label on the top of the interface board. The first two characters indicate the country of manufacture, and the last five digits are a sequential number assigned to each mainframe.

## Additional Information

For Agilent E4360 SAS mainframes, you can query the model number, serial number, firmware revision, backup and active firmware.

For output modules, you can query the model number, serial number, installed options, voltage, current and power rating.

Front Panel:	SCPI Command:
Select <b>System\About\Frame</b> . or	For mainframe information: *IDN?
Select <b>System\About\Module</b> .	For information about the output module in channel 1: SYST:CHAN:MOD? (@1) SYST:CHAN:OPT? (@1) SYST:CHAN:SER? (@1)

## Firmware Upgrade

You can query the instrument's firmware revision either from the front panel or over the remote interface as previously described under "Additional Information".

To upgrade your instrument with the latest firmware revision, go to <http://www.agilent.com/find/E4360firmware>. The upgrade procedure consists of the following three steps:

- Download and install the Agilent E4360 Firmware Update Utility from the Web.
- Download and unzip the Agilent E4360 Firmware Update file from the Web.
- Run the Agilent E4360 Firmware Update Utility and update the firmware on your instrument.



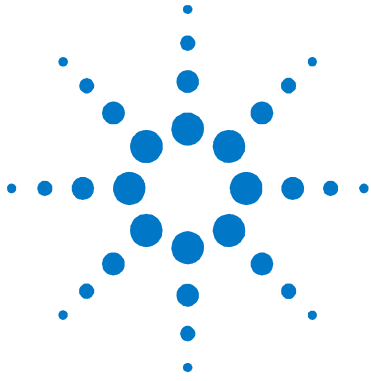

## 2

# Performance Verification

<a href="#">Verification Description</a> .....	10
<a href="#">Verification Procedure</a> .....	12
<a href="#">Constant Current Tests</a> .....	15
<a href="#">Test Record Forms</a> .....	18

The verification procedures described in this chapter verify that the Agilent E4360 Series Solar Array Simulator is operating normally and is within published specifications.

**NOTE**

Perform the verification tests before calibrating your solar array simulator. If the solar array simulator passes the verification tests, the unit is operating within its calibration limits and does not need to be re-calibrated.

---

## Verification Description

Verification procedures perform two primary functions:

**Performance Tests** These tests verify that the solar array simulator is operating normally and meets the specifications published in Appendix A in the User's Guide.

**Calibration Tests** These tests verify that the solar array simulator is operating within its calibration limits.

If the solar array simulator fails any of the tests or if abnormal test results are obtained, try calibrating the unit. If calibration is unsuccessful, return the unit to an Agilent Technologies Service Center.

## Equipment Required

The equipment listed in the following table, or the equivalent to this equipment, is required for the performance tests and for calibration. Test record sheets are included at the back of this section.

Type	Specifications	Recommended Model
Current monitor	15 A (0.1 ohm), TC=4ppm/°	Guildline 9230A/15R
DC power supply	5 V, 5 A (for negative current readback)	Agilent 6611C or equivalent
Digital multimeter	Resolution: 10 nV @ 1V; Readout: 8 1/2 digits Accuracy: 20 ppm	Agilent 3458A or equivalent
Load resistors	3 – 8Ω 300W (for CV ripple & noise) 1 – 3.1Ω 300W (for CV ripple & noise)	Ohmite C300K8R0E Ohmite C300K3R1E
Electronic load	120 V, 8.5 A minimum, with transient capability and a slew rate of 833 kA/s or better.	Agilent N3300A mainframe, with N330xA modules
GPIB controller	Full GPIB capabilities	Agilent 82350B or equivalent
Oscilloscope	Sensitivity: 1 mV Bandwidth limit: 20 MHz Probe: 1:1 with RF tip	Agilent Infiniium or equivalent
RMS voltmeter	True RMS Bandwidth: 20 MHz Sensitivity: 100 μV	Rohde & Schwarz URE3 RMS/Peak voltmeter or equivalent
Differential amplifier	Bandwidth: 20 MHz (for CV ripple & noise)	LaCroy 1855A, DA1850A, or equivalent
Variable-voltage transformer or AC source	Adjustable to highest rated input voltage range. Power: 1000 VA	Agilent 6813B or equivalent

## Measurement Techniques

### Voltmeter

To ensure that the values read by the voltmeter during both the verification procedure and the calibration procedure are not affected by the instantaneous measurement of the AC peaks of the output current ripple, several DC measurements should be made and averaged.

If you are using an Agilent 3458A DMM, you can set up the voltmeter to do this automatically. From the instrument's front panel, program 100 power line cycles per measurement.

Press NPLC 100 ENTER.

### Current-Monitoring Resistor

The 4-terminal current shunt is used to eliminate output current measurement error caused by voltage drops in the load leads and connections. It has special current-monitoring terminals inside the load connection terminals. Connect the voltmeter directly to these current-monitoring terminals.

### Electronic Load

Many of the test procedures require the use of a variable load capable of dissipating the required power. If a variable resistor is used, switches should be used to connect, disconnect, or short the load resistor. For most tests, an electronic load can be used. The electronic load is considerably easier to use than load resistors, but it may be too noisy for the noise (PARD) tests.

Fixed load resistors may be used in place of a variable load, with minor changes to the test procedures. Also, if computer controlled test setups are used, the relatively slow (compared to computers and system voltmeters) settling times and slew rates of the solar array simulator may have to be taken into account. "Wait" statements can be used in the test program if the test system is faster than the solar array simulator.

### Verification Test Set-up

The following figures illustrate the test set-ups used for the verification procedures.

## 2 Performance Verification

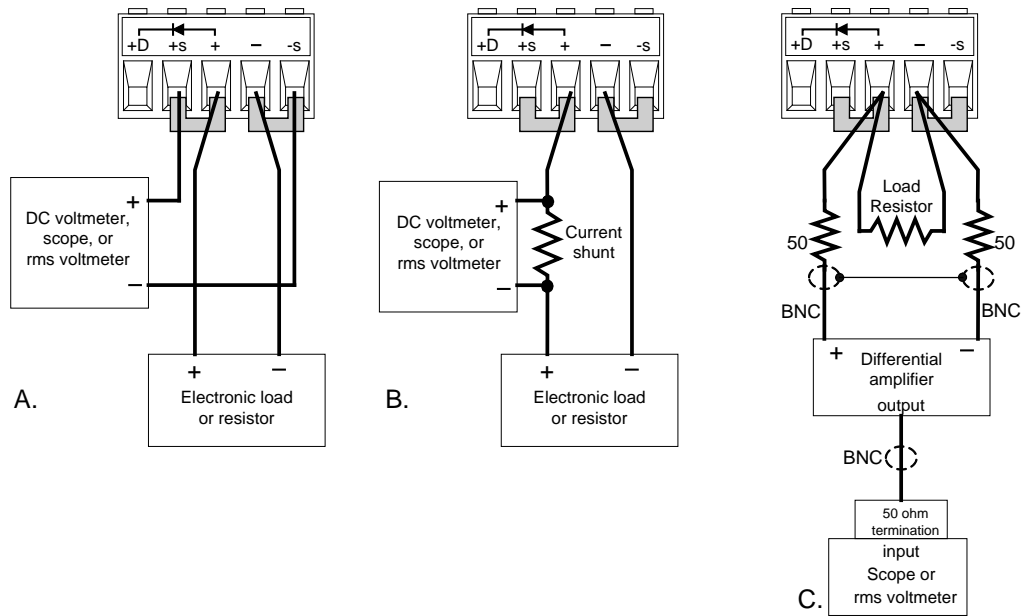

## Verification Procedure

### Constant Voltage Tests

**NOTE**

Test each output channel individually. Refer to the appropriate test record form for the instrument settings of the model you are checking.

#### Voltage Programming and Readback Accuracy

*Test category = performance, calibration*

This test verifies that the voltage programming and measurement functions are within specifications.

- 1 Turn off the solar array simulator and connect a DMM directly across the sense terminals (see Test Setup figure A). Do not connect a load.
- 2 Turn on the solar array simulator and program the instrument as indicated in the test record form under “Voltage Programming & Readback, Min Voltage” with the load off. The CV annunciator should be on and the output current should be close to zero.
- 3 Record the output voltage reading from the DMM and the voltage measured over the interface. The readings should be within the limits specified in the test record form under “Voltage measured over interface” for Min Voltage.
- 4 Program the instrument as described in the test record form under “Voltage Programming & Readback, High Voltage”.
- 5 Record the output voltage reading from the DMM and the voltage measured over the interface. The readings should be within the limits specified in the test record form under “Voltage measured over interface” for High Voltage.

### CV Load Effect

*Test category = performance*

This test measures the change in output voltage resulting from a change in output current from full load to no load.

- 1 Turn off the solar array simulator and connect a DMM and an electronic load (see Test Setup figure A).
- 2 Turn on the solar array simulator and program the instrument as indicated in the test record form under “CV Load Effect”.
- 3 Set the electronic load for the output channel’s current as described in the test record form under “CV Load Effect”. The CV annunciator on the front panel must be on. If not, adjust the load so that the output current drops slightly.
- 4 Record the output voltage reading from the DMM.
- 5 Open the load. Record the voltage reading from the DMM again. The difference between the DMM readings in steps 4 and 5 is the load effect, which should not exceed the value listed in the test record form under “CV Load Effect”.

### CV Source Effect

*Test category = performance*

This test measures the change in output voltage that results from a change in AC line voltage from the minimum to maximum value within the line voltage specifications.

- 1 Turn off the solar array simulator and connect the ac power line through a variable voltage transformer or an AC source.
- 2 Connect a DMM and an electronic load (see Test Setup figure A). Set the variable voltage transformer or AC source to nominal line voltage.
- 3 Turn on the solar array simulator and program the instrument as indicated in the test record form under “CV Source Effect”.
- 4 Set the electronic load for the output channel’s current as described in the test record form under “CV Source Effect”. The CV annunciator on the front panel must be on. If not, adjust the load so that the output current drops slightly.
- 5 Adjust the transformer or AC source to the lowest rated line voltage (86 VAC).
- 6 Record the output voltage reading from the DMM.
- 7 Adjust the transformer or AC source to the highest rated line voltage (264 VAC).
- 8 Record the output voltage reading on the DMM. The difference between the DMM reading in steps 6 and 8 is the source effect, which should not exceed the value listed in the test record form under “CV Source Effect”.

## CV Ripple and Noise

*Test category = performance*

Periodic and random deviations in the output combine to produce a residual AC voltage superimposed on the DC output voltage. This residual voltage is specified as the peak-to-peak or rms noise in the frequency range specified in Appendix A in the User's Guide.

- 1 Turn off the solar array simulator and connect the load resistor (not the electronic load), differential amplifier, and an oscilloscope (ac coupled) to the output (see Test Setup figure D). Use a 7.1  $\Omega$  load for Model E4361A (two 8  $\Omega$  resistors in parallel with one 3.1  $\Omega$  resistor in series). Use a 24  $\Omega$  load for model E4362A (three 8  $\Omega$  resistors in series).
- 2 As shown in the diagram, use two BNC cables to connect the differential amplifier to the + and – output terminals. Each cable should be terminated by a 50  $\Omega$  resistor. The shields of the two BNC cables should be connected together. Connect the output of the differential amplifier to the oscilloscope with a 50  $\Omega$  termination at the input of the oscilloscope.
- 3 Set the differential amplifier to multiply by ten, divide by one, and 1 Megohm input resistance. The positive and negative inputs of the differential amplifier should be set to AC coupling. Set the oscilloscope's time base to 5 ms/div, and the vertical scale to 10 mV/div. Turn the bandwidth limit on (usually 20 or 30 MHz), and set the sampling mode to peak detect.
- 4 Turn on the solar array simulator and program the instrument as indicated in the test record form under "CV Ripple and Noise" and enable the output. Let the oscilloscope run for a few seconds to generate enough measurement points. On the Agilent Infiniium scope, the maximum peak-to-peak voltage measurement is shown at the bottom of the screen on the right. Divide this value by 10 to get the CV peak-to-peak noise measurement. The result should not exceed the peak-to-peak limits in the test record form under "CV Ripple and Noise, peak-to-peak (Fixed mode)".
- 5 Disconnect the load from the solar array simulator and check the results again. The results should not exceed the peak-to-peak limits in the test record form under "CV Ripple and Noise, peak-to-peak (Fixed mode)".
- 6 Reconnect the load and program the solar array simulator to SAS mode. Set the instrument as indicated in the in the test record form under "SAS Curve Settings for Ripple and Noise" and enable the output. Let the oscilloscope run for a few seconds to generate enough measurement points. Divide this value by 10 to get the CV peak-to-peak noise measurement. The result should not exceed the peak-to-peak limits in the test record form under "CV Ripple and Noise, peak-to-peak (SAS & Table mode)".
- 7 Disconnect the load from the solar array simulator and check the results again. The results should not exceed the peak-to-peak limits in the test record form under "CV Ripple and Noise, peak-to-peak (SAS & Table mode)".

- 8 Disconnect the oscilloscope and connect an rms voltmeter in its place. Do not disconnect the 50 ohm termination. Program the solar array simulator to Fixed mode. Set the instrument as indicated in the in the test record form under “CV Ripple and Noise” and enable the output. Divide the reading of the rms voltmeter by 10. The result should not exceed the rms limits in the test record form under “CV Ripple and Noise, rms (Fixed mode)”.
- 9 Disconnect the load from the solar array simulator and check the results again. The result should not exceed the rms limits in the test record form under “CV Ripple and Noise, rms (Fixed mode)”.
- 10 Reconnect the load and program the solar array simulator to SAS mode. Set the instrument as indicated in the in the test record form under “SAS Curve Settings for Ripple and Noise” and enable the output. Divide the reading of the rms voltmeter by 10. The result should not exceed the rms limits in the test record form under “CV Ripple and Noise, rms (SAS & Table mode)”.
- 11 Disconnect the load from the solar array simulator and check the results again. The result should not exceed the rms limits in the test record form under “CV Ripple and Noise, rms (SAS & Table mode)”.

## Constant Current Tests

### NOTE

Test each output channel individually. Refer to the appropriate test record form for the instrument settings of the model you are checking.

### Current Programming and Readback Accuracy

*Test category = performance, calibration*

This test verifies that the current programming and measurement functions are within specifications.

- 1 Turn off the solar array simulator and connect the current shunt directly across the output terminals. Connect the DMM directly across the current shunt (see Test Setup figure B). Note that the electronic load is not used in this portion of the test.
- 2 Turn on the solar array simulator and program the instrument settings as indicated in the test record form under “Current Programming & Readback, Min Current”. The CC annunciator should be on and the output voltage should be about zero.
- 3 Divide the voltage drop (DMM reading) across the current shunt by the shunt resistance to convert to amperes and record this value ( $I_{out}$ ). Also, record the current measured over the interface. The readings should be within the limits specified in the test record form under “Current Programming and Readback, Min Current”.

- 4 Program the instrument settings as described in the test record form under “Current Programming & Readback, High Current”.
- 5 Divide the voltage drop (DMM reading) across the current shunt by the shunt resistance to convert to amperes and record this value ( $I_{out}$ ). Also, record the current reading measured over the interface. The readings should be within the limits specified in the test record form under “Current Programming and Readback, High Current”.

### Current Sink Readback

*Test category = performance*

This test verifies current sink operation and readback.

- 1 Turn off the solar array simulator and connect the output as shown in Test Setup figure B, except connect a DC power supply in place of the electronic load. The polarity of the power supply should be the same as the electronic load.
- 2 Set the external power supply to 5 V and its current limit to 20% of the full scale current value of the output under test. For a full scale current of 5 A, set the external supply's current limit to 1 A. For a full scale current of 8.5 A, set the current limit to 1.7 A.
- 3 Turn on the solar array simulator and program the output voltage to zero. The current on the display should be approximately 20% of the full-scale current.
- 4 Divide the voltage drop across the current monitoring resistor by its resistance to obtain the current sink value in amps and subtract this from the current reading on the display. The difference between the readings should be within the limits specified in the Performance Test Record Form under “–Current measured over interface.”

### CC Load Effect

*Test category = performance*

This test measures the change in output current resulting from a change in output voltage from full scale to short circuit.

- 1 Turn off the solar array simulator and connect the current shunt, DMM, and electronic load (see Test Setup figure B). Connect the DMM directly across the current shunt.
- 2 Turn on the solar array simulator and program the instrument as indicated in the test record form under “CC Load Effect”.
- 3 Set the electronic load for CV mode and program it to the output channel's voltage as described in the test record form under “CC Load Effect”. The CC annunciator on the front panel must be on. If not, adjust the load so that the output voltage drops slightly.

- 4 Divide the voltage drop (DMM reading) across the current monitoring resistor by its resistance to convert to amperes and record this value ( $I_{out}$ ).
- 5 Short the electronic load. Divide the voltage drop (DMM reading) across the current monitoring resistor by its resistance to convert to amperes and record this value ( $I_{out}$ ). The difference in the current readings in steps 4 and 5 is the load effect, which should not exceed the value listed in the test record form under “CC Load Effect”.

### CC Source Effect

*Test category = performance*

This test measures the change in output current that results from a change in AC line voltage from the minimum to maximum value within the line voltage specifications.

- 1 Turn off the solar array simulator and connect the ac power line through a variable voltage transformer or AC source.
- 2 Connect the current shunt, DMM, and electronic load (see Test Setup figure B). Connect the DMM directly across the current shunt. Set the variable voltage transformer or AC source to nominal line voltage.
- 3 Turn on the solar array simulator and program the instrument as indicated in the test record form under “CC Source Effect”.
- 4 Set the electronic load for the output channel’s voltage under “CC Source Effect”. The CC annunciator on the front panel must be on. If not, adjust the load so that the output voltage drops slightly.
- 5 Adjust the transformer or AC source to the lowest rated line voltage (86 VAC).
- 6 Divide the voltage drop (DMM reading) across the current monitoring resistor by its resistance to convert to amperes and record this value ( $I_{out}$ ).
- 7 Adjust the transformer or AC source to the highest rated line voltage (264 VAC).
- 8 Divide the voltage drop (DMM reading) across the current monitoring resistor by its resistance to convert to amperes and record this value ( $I_{out}$ ). The difference between the DMM reading in steps 6 and 8 is the source effect, which should not exceed the value listed in the test record form under “CC Source Effect”.

## Test Record Forms

### Test Record Form – Agilent E4361A

Agilent Model E4361A	Report No _____	Date _____	
Description	Minimum Specs.	Results	Maximum Specs.
<b>Constant Voltage Tests</b>			
<b>Voltage Programming &amp; Readback</b>			
Min. Voltage Vout	– 25 mV	_____	+ 25 mV
Voltage measured over interface	Vout – 25 mV	_____	Vout + 25 mV
High Voltage Vout	59.93 V	_____	60.07 V
Voltage measured over interface	Vout – 73 mV	_____	Vout + 73 mV
<b>CV Load Effect</b>			
	– 2 mV	_____	+ 2 mV
<b>CV Source Effect</b>			
	– 2 mV	_____	+ 2 mV
<b>CV Ripple and Noise (at full and no load)</b>			
peak-to-peak (Fixed mode)	N/A	_____	+ 150 mV
rms (Fixed mode)	N/A	_____	+ 24 mV
peak-to-peak (SAS & Table mode)	N/A	_____	+ 125 mV
rms (SAS & Table mode)	N/A	_____	+ 20 mV
<b>Constant Current Tests</b>			
<b>Current Programming &amp; Readback</b>			
Min. Current Iout	– 20 mA	_____	+ 20 mA
Current measured over interface	Iout – 20 mA	_____	Iout + 20 mA
High Current Iout	8.463 A	_____	8.537 A
Current measured over interface	Iout – 37 mA	_____	Iout + 37 mA
–Current measured over interface (@ 1.7 A)	Iout – 54 mA	_____	Iout – 54 mA
<b>CC Load Effect</b>			
	– 1 mA	_____	+ 1 mA
<b>CC Source Effect</b>			
	– 1 mA	_____	+ 1 mA
<b>E4361A Settings</b>			
Test Description	E4361A Setting		
<b>Voltage Programming &amp; Readback, Min</b>	0 mV, 8.67 A		
<b>Voltage Programming &amp; Readback, High</b>	60 V, 8.67 A		
<b>CV Load Effect, Source Effect, Ripple and Noise</b>	60 V, 8.67 A; Rload for ripple & noise= 7.1Ω		
<b>Current Programming &amp; Readback, Min</b>	0 mA, 61.5 V		
<b>Current Programming &amp; Readback, High</b>	8.5 A, 61.5 V		
<b>CC Load Effect, Source Effect</b>	8.5 A, 61.5 V		
<b>SAS Curve settings for Ripple and Noise tests</b>	Isc = 8.5; Imp = 8.5; Vmp = 60; Voc = 65		

## Test Record Form – Agilent E4361A-J01

Agilent Model E4361A-J01	Report No _____	Date _____	
Description	Minimum Specs.	Results	Maximum Specs.
<b>Constant Voltage Tests</b>			
<b>Voltage Programming &amp; Readback</b>			
Min. Voltage Vout	– 22 mV	_____	+ 22 mV
Voltage measured over interface	Vout – 22 mV	_____	Vout + 22 mV
High Voltage Vout	53.438 V	_____	53.562 V
Voltage measured over interface	Vout – 64.8 mV	_____	Vout + 64.8 mV
<b>CV Load Effect</b>			
	– 2 mV	_____	+ 2 mV
<b>CV Source Effect</b>			
	– 2 mV	_____	+ 2 mV
<b>CV Ripple and Noise (at full and no load)</b>			
peak-to-peak (Fixed mode)	N/A	_____	+ 150 mV
rms (Fixed mode)	N/A	_____	+ 24 mV
peak-to-peak (SAS & Table mode)	N/A	_____	+ 125 mV
rms (SAS & Table mode)	N/A	_____	+ 20 mV
<b>Constant Current Tests</b>			
<b>Current Programming &amp; Readback</b>			
Min. Current Iout	– 22 mA	_____	+ 22 mA
Current measured over interface	Iout – 23 mA	_____	Iout + 23 mA
High Current Iout	9.2594 A	_____	9.3406 A
Current measured over interface	Iout – 41.6 mA	_____	Iout + 41.6 mA
–Current measured over interface (@ 1.7 A)	Iout – 59 mA	_____	Iout – 59 mA
<b>CC Load Effect</b>			
	– 1 mA	_____	+ 1 mA
<b>CC Source Effect</b>			
	– 1 mA	_____	+ 1 mA
<b>Test Description</b>		<b>E4361A-J01 Setting</b>	
<b>Voltage Programming &amp; Readback, Min</b>		0 mV, 9.48 A	
<b>Voltage Programming &amp; Readback, High</b>		53.5 V, 9.48 A	
<b>CV Load Effect, Source Effect, Ripple and Noise</b>		53.5 V, 9.48 A; Rload for ripple & noise= 5.75Ω	
<b>Current Programming &amp; Readback, Min</b>		0 mA, 54.8 V	
<b>Current Programming &amp; Readback, High</b>		9.3 A, 54.8 V	
<b>CC Load Effect, Source Effect</b>		9.3 A, 54.8 V	
<b>SAS Curve settings for Ripple and Noise tests</b>		Isc = 9.3; Imp = 9.3; Vmp = 53.5; Voc = 58	

## Test Record Form – Agilent E4361A-J02

Agilent Model E4361A-J02	Report No _____	Date _____	
Description	Minimum Specs.	Results	Maximum Specs.
<b>Constant Voltage Tests</b>			
<b>Voltage Programming &amp; Readback</b>			
Min. Voltage Vout	- 29 mV	_____	+ 29 mV
Voltage measured over interface	Vout - 29 mV	_____	Vout + 29 mV
High Voltage Vout	69.1191 V	_____	69.2809 V
Voltage measured over interface	Vout - 84.3 mV	_____	Vout + 84.3 mV
<b>CV Load Effect</b>			
	- 2 mV	_____	+ 2 mV
<b>CV Source Effect</b>			
	- 2 mV	_____	+ 2 mV
<b>CV Ripple and Noise (at full and no load)</b>			
peak-to-peak (Fixed mode)	N/A	_____	+ 150 mV
rms (Fixed mode)	N/A	_____	+ 25 mV
peak-to-peak (SAS & Table mode)	N/A	_____	+ 136 mV
rms (SAS & Table mode)	N/A	_____	+ 21 mV
<b>Constant Current Tests</b>			
<b>Current Programming &amp; Readback</b>			
Min. Current Iout	- 19 mA	_____	+ 19 mA
Current measured over interface	Iout - 19 mA	_____	Iout + 19 mA
High Current Iout	7.965 A	_____	8.035 A
Current measured over interface	Iout - 35 mA	_____	Iout + 35 mA
-Current measured over interface (@ 1.7 A)	Iout - 52 mA	_____	Iout - 52 mA
<b>CC Load Effect</b>			
	- 1 mA	_____	+ 1 mA
<b>CC Source Effect</b>			
	- 1 mA	_____	+ 1 mA
<b>Test Description</b>		<b>E4361A-J02 Setting</b>	
<b>Voltage Programming &amp; Readback, Min</b>		0 mV, 8.16 A	
<b>Voltage Programming &amp; Readback, High</b>		69.2 V, 8.16 A	
<b>CV Load Effect, Source Effect, Ripple and Noise</b>		69.2 V, 8.16 A; Rload for ripple & noise= 8.65Ω	
<b>Current Programming &amp; Readback, Min</b>		0 mA, 71 V	
<b>Current Programming &amp; Readback, High</b>		8 A, 71 V	
<b>CC Load Effect, Source Effect</b>		8 A, 71 V	
<b>SAS Curve settings for Ripple and Noise tests</b>		Isc = 8; Imp = 8; Vmp = 69.2; Voc = 75	

## Test Record Form – Agilent E4362A and E4362A-J51

Agilent Model E4362A & E4362A-J51	Report No _____	Date _____	
Description	Minimum Specs.	Results	Maximum Specs.
<b>Constant Voltage Tests</b>			
<b>Voltage Programming &amp; Readback</b>			
Min. Voltage Vout	– 50 mV	_____	+ 50 mV
Voltage measured over interface	Vout – 50 mV	_____	Vout + 50 mV
High Voltage Vout	119.86 V	_____	120.14 V
Voltage measured over interface	Vout – 146 mV	_____	Vout + 146 mV
<b>CV Load Effect</b>			
	– 2 mV	_____	+ 2 mV
<b>CV Source Effect</b>			
	– 2 mV	_____	+ 2 mV
<b>CV Ripple and Noise (at full and no load)</b>			
peak-to-peak (Fixed mode)	N/A	_____	+ 150 mV
rms (Fixed mode)	N/A	_____	+ 30 mV
peak-to-peak (SAS & Table mode)	N/A	_____	+ 195 mV
rms (SAS & Table mode)	N/A	_____	+ 24 mV
<b>Constant Current Tests</b>			
<b>Current Programming &amp; Readback</b>			
Min. Current Iout	– 10 mA	_____	+ 10 mA
Current measured over interface	Iout – 10 mA	_____	Iout + 10 mA
High Current Iout	4.98 A	_____	5.02 A
Current measured over interface	Iout – 20 mA	_____	Iout + 20 mA
–Current measured over interface (@ 1 A)	Iout – 27.5 mA	_____	Iout + 27.5 mA
<b>CC Load Effect</b>			
	– 1 mA	_____	+ 1 mA
<b>CC Source Effect</b>			
	– 1 mA	_____	+ 1 mA
<b>Test Settings</b>			
Test Description	E4362A & E4362A-J51 Setting		
<b>Voltage Programming &amp; Readback, Min</b>	0 mV, 5.1 A		
<b>Voltage Programming &amp; Readback, High</b>	120 V, 5.1 A		
<b>CV Load Effect, Source Effect, Ripple and Noise</b>	120 V, 5.1 A; Rload for ripple & noise = 24Ω		
<b>Current Programming &amp; Readback, Min</b>	0 mA, 123 V		
<b>Current Programming &amp; Readback, High</b>	5 A, 123 V		
<b>CC Load Effect, Source Effect</b>	5 A, 123 V		
<b>SAS Curve settings for Ripple and Noise tests</b>	Isc = 5; Imp = 5; Vmp = 120; Voc = 130		

## Test Record Form – Agilent E4362A-J01

Agilent Model E4362A-J01	Report No _____	Date _____	
Description	Minimum Specs.	Results	Maximum Specs.
<b>Constant Voltage Tests</b>			
<b>Voltage Programming &amp; Readback</b>			
Min. Voltage Vout	– 50 mV	_____	+ 50 mV
Voltage measured over interface	Vout – 50 mV	_____	Vout + 50 mV
High Voltage Vout	107.869 V	_____	108.131 V
Voltage measured over interface	Vout – 136 mV	_____	Vout + 136 mV
<b>CV Load Effect</b>			
	– 2 mV	_____	+ 2 mV
<b>CV Source Effect</b>			
	– 2 mV	_____	+ 2 mV
<b>CV Ripple and Noise (at full and no load)</b>			
peak-to-peak (Fixed mode)	N/A	_____	+ 150 mV
rms (Fixed mode)	N/A	_____	+ 30 mV
peak-to-peak (SAS & Table mode)	N/A	_____	+ 195 mV
rms (SAS & Table mode)	N/A	_____	+ 24 mV
<b>Constant Current Tests</b>			
<b>Current Programming &amp; Readback</b>			
Min. Current Iout	– 11 mA	_____	+ 11 mA
Current measured over interface	Iout – 11 mA	_____	Iout + 11 mA
High Current Iout	5.478 A	_____	5.522 A
Current measured over interface	Iout – 22 mA	_____	Iout + 22 mA
–Current measured over interface (@ 1 A)	Iout – 29.5 mA	_____	Iout + 29.5 mA
<b>CC Load Effect</b>			
	– 1 mA	_____	+ 1 mA
<b>CC Source Effect</b>			
	– 1 mA	_____	+ 1 mA
<b>Test Description</b>		<b>E4362A-J01 Setting</b>	
<b>Voltage Programming &amp; Readback, Min</b>		0 mV, 5.61 A	
<b>Voltage Programming &amp; Readback, High</b>		108 V, 5.61 A	
<b>CV Load Effect, Source Effect, Ripple and Noise</b>		108 V, 5.61 A; Rload for ripple & noise = 20Ω	
<b>Current Programming &amp; Readback, Min</b>		0 mA, 110.7 V	
<b>Current Programming &amp; Readback, High</b>		5.5 A, 110.7 V	
<b>CC Load Effect, Source Effect</b>		5.5 A, 110.7 V	
<b>SAS Curve settings for Ripple and Noise tests</b>		Isc = 5.5; Imp = 5.5; Vmp = 108; Voc = 117	

## Test Record Form – Agilent E4362A-J02

Agilent Model E4362A-J02	Report No _____	Date _____	
Description	Minimum Specs.	Results	Maximum Specs.
<b>Constant Voltage Tests</b>			
<b>Voltage Programming &amp; Readback</b>			
Min. Voltage Vout	– 50 mV	_____	+ 50 mV
Voltage measured over interface	Vout – 50 mV	_____	Vout + 50 mV
High Voltage Vout	109.8675 V	_____	110.1325 V
Voltage measured over interface	Vout – 138 mV	_____	Vout + 138 mV
<b>CV Load Effect</b>	– 2 mV	_____	+ 2 mV
<b>CV Source Effect</b>	– 2 mV	_____	+ 2 mV
<b>CV Ripple and Noise (at full and no load)</b>			
peak-to-peak (Fixed mode)	N/A	_____	+ 150 mV
rms (Fixed mode)	N/A	_____	+ 30 mV
peak-to-peak (SAS & Table mode)	N/A	_____	+ 195 mV
rms (SAS & Table mode)	N/A	_____	+ 24 mV
<b>Constant Current Tests</b>			
<b>Current Programming &amp; Readback</b>			
Min. Current Iout	– 11 mA	_____	+ 11 mA
Current measured over interface	Iout – 11 mA	_____	Iout + 11 mA
High Current Iout	5.3782 A	_____	5.4218 A
Current measured over interface	Iout – 21.8 mA	_____	Iout + 21.8 mA
–Current measured over interface (@ 1 A)	Iout – 29.5 mA	_____	Iout + 29.5 mA
<b>CC Load Effect</b>	– 1 mA	_____	+ 1 mA
<b>CC Source Effect</b>	– 1 mA	_____	+ 1 mA
<b>Test Description</b>		<b>E4362A-J02 Setting</b>	
<b>Voltage Programming &amp; Readback, Min</b>		0 mV, 5.51 A	
<b>Voltage Programming &amp; Readback, High</b>		110 V, 5.51 A	
<b>CV Load Effect, Source Effect, Ripple and Noise</b>		110 V, 5.51 A; Rload for ripple & noise = 20Ω	
<b>Current Programming &amp; Readback, Min</b>		0 mA, 112.75 V	
<b>Current Programming &amp; Readback, High</b>		5.4 A, 112.75 V	
<b>CC Load Effect, Source Effect</b>		5.4 A, 112.75 V	
<b>SAS Curve settings for Ripple and Noise tests</b>		Isc = 5.4; Imp = 5.4; Vmp = 110; Voc = 120	

### Test Record Form – Agilent E4362A-J03 and E4362A-J52

Agilent Model E4362A-J03 & E4362A-J52	Report No _____	Date _____	
Description	Minimum Specs.	Results	Maximum Specs.
<b>Constant Voltage Tests</b>			
<b>Voltage Programming &amp; Readback</b>			
Min. Voltage Vout	- 42 mV	_____	+ 42 mV
Voltage measured over interface	Vout - 42 mV	_____	Vout + 42 mV
High Voltage Vout	99.883 V	_____	100.117 V
Voltage measured over interface	Vout - 122 mV	_____	Vout + 122 mV
<b>CV Load Effect</b>			
	- 2 mV	_____	+ 2 mV
<b>CV Source Effect</b>			
	- 2 mV	_____	+ 2 mV
<b>CV Ripple and Noise (at full and no load)</b>			
peak-to-peak (Fixed mode)	N/A	_____	+ 150 mV
rms (Fixed mode)	N/A	_____	+ 28 mV
peak-to-peak (SAS & Table mode)	N/A	_____	+ 172 mV
rms (SAS & Table mode)	N/A	_____	+ 23 mV
<b>Constant Current Tests</b>			
<b>Current Programming &amp; Readback</b>			
Min. Current Iout	- 12 mA	_____	+ 12 mA
Current measured over interface	Iout - 12 mA	_____	Iout + 12 mA
High Current Iout	5.976 A	_____	6.024 A
Current measured over interface	Iout - 24 mA	_____	Iout + 24 mA
-Current measured over interface (@ 1 A)	Iout - 32.5 mA	_____	Iout + 32.5 mA
<b>CC Load Effect</b>			
	- 1 mA	_____	+ 1 mA
<b>CC Source Effect</b>			
	- 1 mA	_____	+ 1 mA
<hr/>			
Test Description	E4362A-J03 & E4362A-J52 Setting		
<b>Voltage Programming &amp; Readback, Min</b>	0 mV, 6.12 A		
<b>Voltage Programming &amp; Readback, High</b>	100 V, 6.12 A		
<b>CV Load Effect, Source Effect, Ripple and Noise</b>	100 V, 6.12 A; Rload for ripple & noise = 16.7Ω		
<b>Current Programming &amp; Readback, Min</b>	0 mA, 102.5 V		
<b>Current Programming &amp; Readback, High</b>	6 A, 102.5 V		
<b>CC Load Effect, Source Effect</b>	6 A, 102.5 V		
<b>SAS Curve settings for Ripple and Noise tests</b>	Isc = 6; Imp = 6; Vmp = 100; Voc = 108		

## Test Record Form – Agilent E4362A-J04

Agilent Model E4362A-J04	Report No _____	Date _____	
Description	Minimum Specs.	Results	Maximum Specs.
<b>Constant Voltage Tests</b>			
<b>Voltage Programming &amp; Readback</b>			
Min. Voltage Vout	– 66 mV	_____	+ 66 mV
Voltage measured over interface	Vout – 66 mV	_____	Vout + 66 mV
High Voltage Vout	156.81625 V	_____	157.18375 V
Voltage measured over interface	Vout – 191.6 mV	_____	Vout + 191.6 mV
<b>CV Load Effect</b>			
	– 2 mV	_____	+ 2 mV
<b>CV Source Effect</b>			
	– 2 mV	_____	+ 2 mV
<b>CV Ripple and Noise (at full and no load)</b>			
peak-to-peak (Fixed mode)	N/A	_____	+ 150 mV
rms (Fixed mode)	N/A	_____	+ 34 mV
peak-to-peak (SAS & Table mode)	N/A	_____	+ 239 mV
rms (SAS & Table mode)	N/A	_____	+ 27 mV
<b>Constant Current Tests</b>			
<b>Current Programming &amp; Readback</b>			
Min. Current Iout	– 8 mA	_____	+ 8 mA
Current measured over interface	Iout – 8 mA	_____	Iout + 8 mA
High Current Iout	3.7844 A	_____	3.8156 A
Current measured over interface	Iout – 15.6 mA	_____	Iout + 15.6 mA
–Current measured over interface (@ 1 A)	Iout – 22.5 mA	_____	Iout + 22.5 mA
<b>CC Load Effect</b>			
	– 1 mA	_____	+ 1 mA
<b>CC Source Effect</b>			
	– 1 mA	_____	+ 1 mA
<b>Test Description</b>		<b>E4362A-J04 Setting</b>	
<b>Voltage Programming &amp; Readback, Min</b>		0 mV, 3.876 A	
<b>Voltage Programming &amp; Readback, High</b>		157 V, 3.876 A	
<b>CV Load Effect, Source Effect, Ripple and Noise</b>		157 V, 3.876 A; Rload for ripple & noise = 41.3Ω	
<b>Current Programming &amp; Readback, Min</b>		0 mA, 160.9 V	
<b>Current Programming &amp; Readback, High</b>		3.8 A, 160.9 V	
<b>CC Load Effect, Source Effect</b>		3.8 A, 160.9 V	
<b>SAS Curve settings for Ripple and Noise tests</b>		Isc = 3.8; Imp = 3.8; Vmp = 157; Voc = 170	

### Test Record Form – Agilent E4362A-J05

Agilent Model E4362A-J05	Report No _____	Date _____	
Description	Minimum Specs.	Results	Maximum Specs.
<b>Constant Voltage Tests</b>			
<b>Voltage Programming &amp; Readback</b>			
Min. Voltage Vout	- 37 mV	_____	+ 37 mV
Voltage measured over interface	Vout - 37 mV	_____	Vout + 37 mV
High Voltage Vout	87.5972 V	_____	87.8028 V
Voltage measured over interface	Vout - 107 mV	_____	Vout + 107 mV
<b>CV Load Effect</b>			
	- 2 mV	_____	+ 2 mV
<b>CV Source Effect</b>			
	- 2 mV	_____	+ 2 mV
<b>CV Ripple and Noise (at full and no load)</b>			
peak-to-peak (Fixed mode)	N/A	_____	+ 150 mV
rms (Fixed mode)	N/A	_____	+ 27 mV
peak-to-peak (SAS & Table mode)	N/A	_____	+ 158 mV
rms (SAS & Table mode)	N/A	_____	+ 22 mV
<b>Constant Current Tests</b>			
<b>Current Programming &amp; Readback</b>			
Min. Current Iout	- 15 mA	_____	+ 15 mA
Current measured over interface	Iout - 15 mA	_____	Iout + 15 mA
High Current Iout	6.2724 A	_____	6.3276 A
Current measured over interface	Iout - 27.6 mA	_____	Iout + 27.6 mA
-Current measured over interface (@ 1 A)	Iout - 39.5 mA	_____	Iout + 39.5 mA
<b>CC Load Effect</b>			
	- 1 mA	_____	+ 1 mA
<b>CC Source Effect</b>			
	- 1 mA	_____	+ 1 mA
<b>Test Description</b>		<b>E4362A-J05 Setting</b>	
<b>Voltage Programming &amp; Readback, Min</b>		0 mV, 6.426 A	
<b>Voltage Programming &amp; Readback, High</b>		87.7 V, 6.426 A	
<b>CV Load Effect, Source Effect, Ripple and Noise</b>		87.7 V, 6.426 A; Rload for ripple & noise = 13.9Ω	
<b>Current Programming &amp; Readback, Min</b>		0 mA, 89.9 V	
<b>Current Programming &amp; Readback, High</b>		6.3 A, 89.9 V	
<b>CC Load Effect, Source Effect</b>		6.3 A, 89.9 V	
<b>SAS Curve settings for Ripple and Noise tests</b>		Isc = 6.3; Imp = 6.3; Vmp = 87.7; Voc = 95	

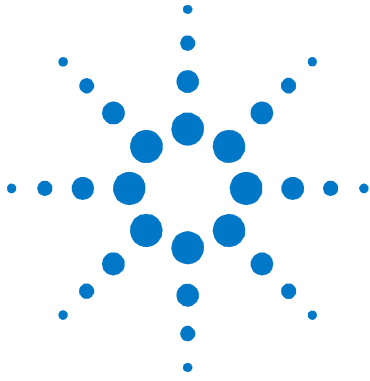

# 3 Calibration

<a href="#">Calibration Description</a> .....	28
<a href="#">Calibration Procedure</a> .....	29

This chapter includes calibration procedures for the Agilent E4360 Series Solar Array Simulator. Instructions are given for performing the procedures from either the front panel or a controller over the remote interface.

Refer to the “Equipment Required” section in chapter 2 for a list of the equipment required for calibration. Also refer to “Measurement Techniques” for information about connecting the voltmeter and current shunt.

**NOTE**

Perform the verification tests before calibrating your solar array simulator. If the solar array simulator passes the verification tests, the unit is operating within its calibration limits and does not need to be re-calibrated.

---

### Calibration Interval

The recommended calibration interval for Agilent E4361A/E4362A output modules is one year. Agilent E4360A SAS mainframes do not require calibration.

## Calibration Description

Refer to the “Equipment Required” section in chapter 2 for a list of the equipment required for calibration. Also refer to “Measurement Techniques” for information about connecting the voltmeter and current shunt. A general outline of the calibration procedure is as follows:

- Enter the calibration mode by providing the correct password. The password is factory-set to 0 (zero). You can change the password once calibration mode is entered to prevent unauthorized access to the calibration mode. Refer to “Change the Calibration Password” at the end of this section.
- Calibrate only ONE channel at a time. The calibration commands accept only a single channel number for the channel parameter. Calibration cannot be performed on channels that have been grouped. If any channels have been grouped, they must be ungrouped before they can be calibrated.
- When calibrating the instrument using SCPI commands, most steps involve sending a \*OPC? query to synchronize with the instrument’s command completion before proceeding. The instrument’s response must be read each time \*OPC? is given.
- **Once started, you must perform the complete calibration procedure in its entirety.** As each calibration section is completed, the instrument calculates new calibration constants and begins using them. However, these constants are not saved in nonvolatile memory until a SAVE command is explicitly given.
- Exit the calibration mode either by logging out of the front panel menu or by sending CAL:STAT OFF. Note that any channels that were calibrated but not saved will revert to their previous calibration constants.

## Calibration Switches

Two switches control the access to calibration commands. The switches are on the interface board and are accessible by removing the top cover. Refer to “Accessing the Calibration switch” in chapter 4. Switches 1 and 2 set the calibration configuration as follows:

	Sw 1	Sw 2	Description
<b>Normal</b>	ON	ON	This is the default or as-shipped switch setting. The calibration functions are accessible after entering a numeric password. The default password is 0 (zero).
<b>Clear password</b>	OFF	ON	The admin/calibration password is reset to 0 when the instrument is first powered on. Use this setting if you have forgotten the password.
<b>Inhibit calibration</b>	OFF	OFF	All calibration commands are disabled. This is useful where calibration access is guarded by instrument seals.

## Calibration Procedure

### Enter Calibration mode

Front Panel:	SCPI Command:
Select <b>System\Admin&gt;Login</b> . Enter your password in the Password field and press Select.	CAL:STAT ON, <password>

### Voltage Programming, Measurement, and Protection Calibration

**Step 1.** Connect the DMM's voltage input to an output channel. Connect the +sense terminal to the +output and the -sense terminal to the -output.

**Step 2.** Select the first voltage calibration point.

Front Panel:	SCPI Command:
Select Next. The information field should indicate: Enter P1 data	CAL:VOLT:LEV P1 *OPC?

**Step 3.** Measure the output voltage with the DMM and enter the data.

Front Panel:	SCPI Command:
Select the Measured Data field. Enter the data from the external DMM. Press Select when done.	CAL:VOLT <data>

**Step 4.** Select the second voltage calibration point.

Front Panel:	SCPI Command:
Select Next. The information field should indicate: Enter P2 data	CAL:VOLT:LEV P2 *OPC?

**Step 5.** Measure the output voltage with the DMM and enter the data.

Front Panel:	SCPI Command:
Select the Measured Data field. Enter the data from the external DMM. Press Select when done.	CAL:VOLT <data>

**Step 6.** Select voltage protection calibration. Note that the output voltage will go to near full-scale during this procedure.

Front Panel:	SCPI Command:
Select OVP. Press Select when done. Press Next to finish calibration	CAL:VOLT:PROT *OPC?

## Current Programming and Measurement Calibration

**Step 7.** Connect the +sense terminal to the +output, and the -sense terminal to the -output. Connect a precision shunt resistor to the output. The shunt resistor should be able to measure at least 120% of the output's rated full-scale current. Connect the DMM across the shunt resistor.

**Step 8.** Select the first current calibration point.

Front Panel:	SCPI Command:
Select Next. The information field should indicate: Enter P1 data	CAL:CURR:LEV P1 *OPC?

**Step 9.** Calculate the shunt current ( $I=V/R$ ) and enter the data.

Front Panel:	SCPI Command:
Select the Measured Data field. Enter the data from the external DMM. Press Select when done.	CAL:CURR <data>

**Step 10.** Select the second current calibration point.

Front Panel:	SCPI Command:
Select Next. The information field should indicate: Enter P2 data	CAL:CURR:LEV P2 *OPC?

**Step 11.** Calculate the shunt current ( $I=V/R$ ) and enter the data.

Front Panel:	SCPI Command:
Select the Measured Data field. Enter the data from the external DMM. Press Select when done. Press Next to finish calibration.	CAL:CURR <data>

**Step 12.** Select current protection calibration.

Front Panel:	SCPI Command:
Select OCP. Press Select when done. Press Next to finish calibration	CAL:CURR:PROT *OPC?

## Save and Exit Calibration Mode

### CAUTION

Storing calibration constants overwrites the existing ones in non-volatile memory. If you are not sure you want to permanently store the new constants, do not Save the data when you exit the calibration mode. The calibration will then remain unchanged.

Front Panel:	SCPI Command:
Select <b>System\Admin\Cal\Date</b> . Enter the calibration date in the Date field. If desired, you can enter alphanumeric data in this field.	To enter a calibration date: CAL:DATE "<date>", (@1)
Select <b>System\Admin\Cal\Save</b> . Select Save to save all calibration data.	To save calibration data: CAL:SAVE
Select <b>System\Admin\Logout</b> to exit calibration mode.	To exit calibration mode: CAL:STAT OFF

## Change the Admin/Calibration Password

The password must be numeric, and can be up to 15 digits in length. After it has been changed, you can only enter the calibration mode by providing the correct password. If the password is lost, access can be restored by setting an internal switch that resets the password to 0. If the message "Locked out by internal switch setting" or "Calibration is inhibited by switch setting" appears, the internal switch is set to prevent the password from being changed (Refer to "Accessing the Calibration switch" in chapter 4).

Front Panel:	SCPI Command:
Select <b>System\Admin&gt;Login</b> . Enter the original password in the Password field and press Select.	Enter calibration mode using the original password CAL:STAT ON, <password>
Select <b>System\Admin&gt;Password</b> . Enter a new password in the Password field.	To change the password: CAL:PASS <NRf>
Logout of the Admin menu to activate the password.	To exit calibration mode and activate the password: CAL:STAT OFF



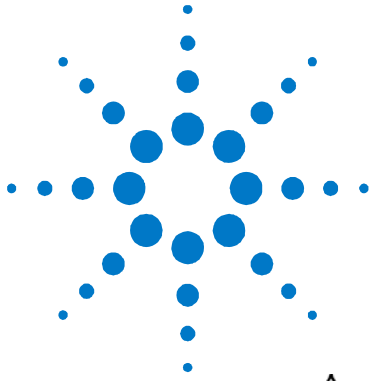

## 4 Disassembly



<a href="#">Electrostatic Discharge (ESD) Precautions</a> .....	34
<a href="#">Disassembly Procedures</a> .....	34
<a href="#">Installing a Redundant Ground for 400 Hz Operation</a> .....	39

This chapter discusses the disassembly procedures for troubleshooting and repairing Agilent E4360 SAS mainframes.

## Electrostatic Discharge (ESD) Precautions

Almost all electrical components can be damaged by electrostatic discharge (ESD) during handling. Component damage can occur at electrostatic discharge voltages as low as 50 volts. The following guidelines will help prevent ESD damage when servicing the instrument or any electronic device.

- Disassemble instruments *only* in a static-free work area.
- Use a conductive work area to reduce static charges.
- Use a conductive wrist strap to reduce static accumulation.
- Minimize handling.
- Keep replacement parts in original static-free packaging.
- Remove all plastic, foam, vinyl, paper, and other static-generating materials from the immediate work area.



## Disassembly Procedures

### WARNING

**SHOCK HAZARD.** Turn off the mainframe and disconnect its power cord before attempting any of the following procedures.

### Required Disassembly Tools

Tool	Use
9/32 Hex driver	Removing GPIB connector
5/16 Hex driver	Removing DC cable assembly from bias supply
T20 Torx driver	Removing bias board, handles, and bulk supply
T10 Torx driver	Removing covers and board assemblies

### Ribbon Cables

- Note the position of the conductive side of the cable for re-installation. (The blue tab is on the non-conductive side.)
- Release the ribbon cable by pulling up on the locking tab as shown by the arrows in the following figure.

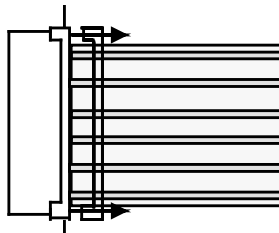

- To replace the cable, fully insert the cable into the connector; then push down on the locking tab to secure the cable.

## Removing/Installing Output Modules

### CAUTION

If you are only installing a single power module, it must be installed in slot 1. The unused slot must have a filler module installed to ensure proper cooling..

- Step 1.** Remove the blower cover. Remove three screws from the top of the cover and four screws on the sides. Tilt the cover up and slide it out.
- Step 2.** To remove a module, first remove the two fastening screws at either end of the module. Grasp the module at the ends and lift it straight up out of the mainframe.
- Step 3.** To install a power module, align the module over the alignment pins, and push it down onto the mainframe connector.
- Step 4.** Fasten the power module or filler module to the mainframe. Use the screws provided with the module and install them at either end of the module.
- Step 5.** Replace the blower cover when finished. Be careful not to bend the spring clips on the edge of the cover when sliding it under the lip of the power modules.

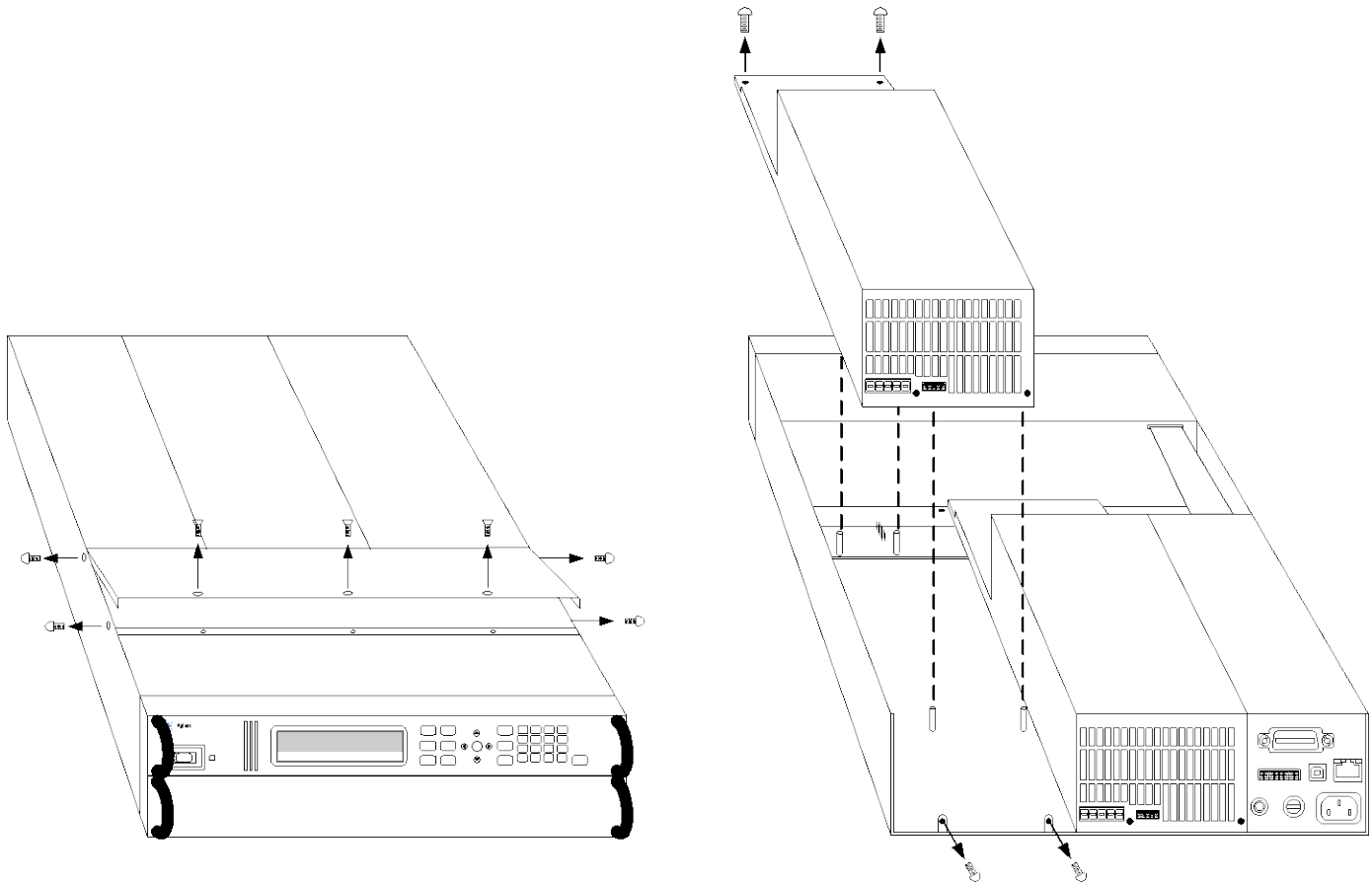

### Accessing the Calibration switch

- Step 1.** Remove the blower cover. Remove three screws from the top of the cover and two screws on the sides. Tilt the cover up and slide it out.
- Step 2.** Remove the interface cover. Remove the three screws along the left side and two at the rear of the unit. Then remove the screw at the front of the cover. Lift off the cover.
- Step 3.** The calibration switch is on the interface board near the ribbon cable. To change the calibration switch settings, use a small screwdriver to move the switches. Refer to chapter 3 for settings information.

**CAUTION** Do not use a pencil to move the switches. Any graphite dust that gets on the switches will conduct electricity.

- Step 4.** Replace all covers when finished.

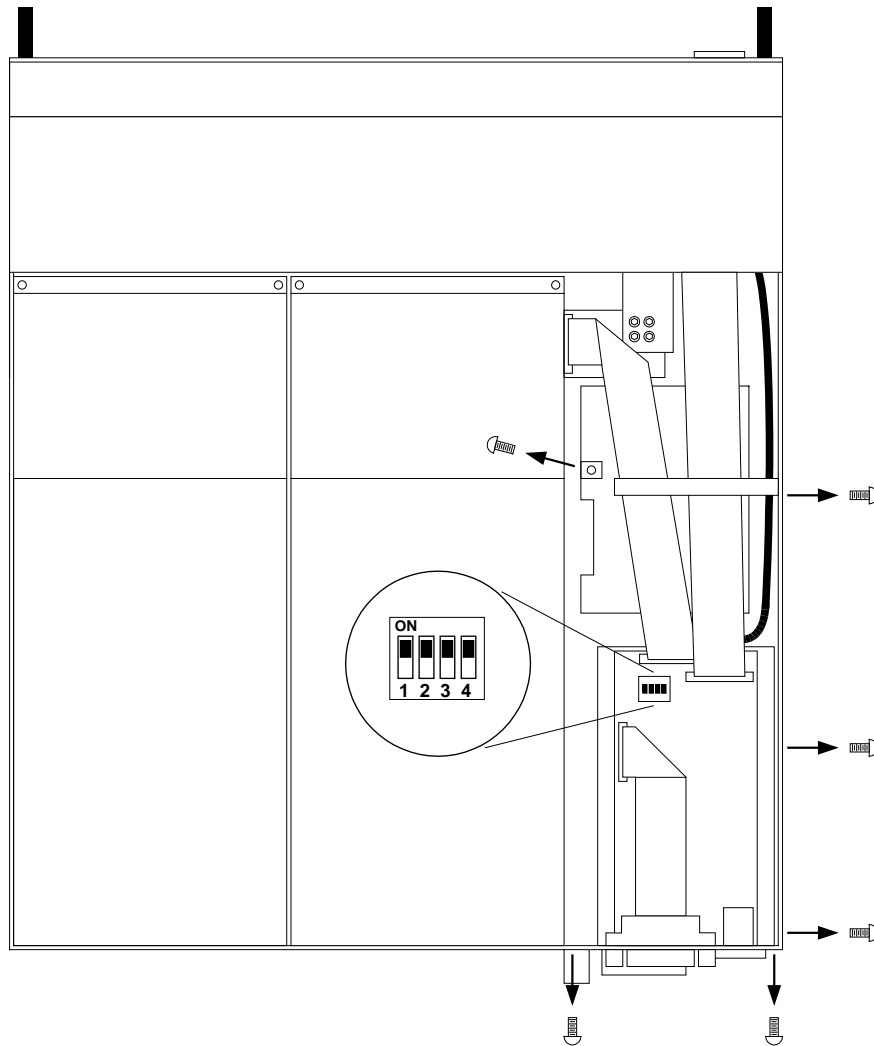

## Removing/Installing the Interface (PPMC) board

- Step 1.** Remove the blower cover. Remove three screws from the top of the cover and two screws on the sides. Tilt the cover up and slide it out.
- Step 2.** Remove the interface cover. Remove the three screws along the left side and two at the rear of the unit. Then remove the screw at the front of the cover. Lift off the cover.
- Step 3.** Use a hex wrench to remove the GPIB connector from the rear of the mainframe. Disconnect all cable assemblies from the interface board.
- Step 4.** Disconnect the 3 cable assemblies located along the front edge of the board. Use a T10 driver and remove the screws that attach the board to the chassis. Lift the board out.
- Step 5.** To reinstall the interface board, perform the above steps in reverse order. Replace all covers when finished.

## Removing/Installing the Bias board

- Step 1.** Remove the blower and interface covers as previously described.
- Step 2.** Disconnect all cable assemblies from the bias board.
- Step 3.** Use a T10 driver and remove the screws that attach the bias board to the chassis. Use a T20 driver and remove the 4 screws that attach the board to the backplane assembly. Lift the board out.
- Step 4.** To reinstall the bias board, perform the above steps in reverse order. Replace all covers when finished.

## Removing/Installing the Front Panel Assembly

- Step 1.** Remove the two screws along the front of the bulk supply cover as well as the four screws on each side of the front panel assembly that attach the front panel assembly to the chassis.
- Step 2.** Slide the front panel assembly forward and away from the chassis to access the test points for troubleshooting.
- Step 3.** To completely remove the front panel assembly, disconnect the ribbon cable between the front panel board and the interface board at the front panel board.
- Step 4.** Disconnect the wires going to the S1 switch assembly. For reassembly, make a note of the color coding of the wires and the pins to which they are connected.

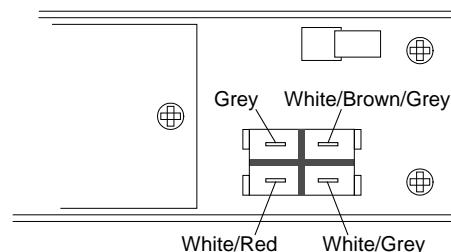

- Step 5.** To remove the front panel board, remove the six screws that secure the board to the front frame assembly.
- Step 6.** To remove the display module, first disconnect the cable at the P1 connector and the ribbon cable at the J2 connector. Then untwist the tabs that hold the display module to the front panel board.
- Step 7.** To reinstall the front panel assembly, perform the above steps in reverse order.

### Removing/Installing the Bulk Supply

- Step 1.** Remove the blower cover, bulk supply cover, and interface cover as previously described.
- Step 2.** Remove the output modules from the mainframe. You now have access to two of the screws that install the bulk supplies.
- Step 3.** Remove the four screws on each side of the front panel assembly that attach the front panel assembly to the chassis. Slide the front panel assembly forward and away from the chassis. You now have access to the remaining screws that install the bulk supplies.
- Step 4.** Use a T20 driver and remove all screws that fasten the bulk supplies to the chassis.
- Step 5.** Disconnect the ribbon cable that connects the interface board to the front panel by gently lifting up on the interface board connector. Slide the ribbon cable out so that you can access the AC and DC cable assembly connectors.
- Step 6** Disconnect the DC and AC cable assemblies and lift the bulk supplies out of the unit. For reassembly, make a note of the color-coding of the wires and the pins to which they are connected.

Cable assembly	Connected to Pin
Red (DC)	+48 V
Black (DC)	-48 V
Grey (AC)	AC
Red/white (AC)	ACC
Green/yellow (AC)	ground

- Step 7.** To reinstall the bulk supplies, perform the above steps in reverse.

## Installing a Redundant Ground for 400 Hz Operation

Operation at 400 Hz requires the installation of a redundant ground from the instrument chassis to earth ground. The redundant ground must be permanently attached to the unit as well as to the earth ground point.

The following procedure only describes how to make the permanent connection at the unit. The user must ensure the integrity and permanence of the connection at the earth ground point.

### The following customer-supplied hardware is required:

- Ground wire (14/16 AWG)
- Uninsulated ring terminal for attaching wire to unit (Tyco p/n 34124 or equivalent)
- Hardware for attaching wire to earth ground point

### The following tools are required to install the redundant ground:

- 3/8 inch hex wrench

- Step 1.** Remove the top cover of the interface board as previously described under “Accessing the Calibration switch”.
- Step 2.** Use the wrench and remove the binding post (1) from the rear of the chassis. The binding post is located between the AC input connector and the GPIB connector.
- Step 3.** Crimp the appropriate ring terminal (2) onto the end of the ground wire.
- Step 4.** Place the ring terminal onto the threaded end of the binding post. Re-install the binding post on the chassis with the washer and nut (3).
- Step 5.** Rotate the ring terminal so that the ground wire does not interfere with any other connectors on the back of the unit. Use the wrench and tighten the binding post to the chassis (Torque = 20 – 25 in-lb.).

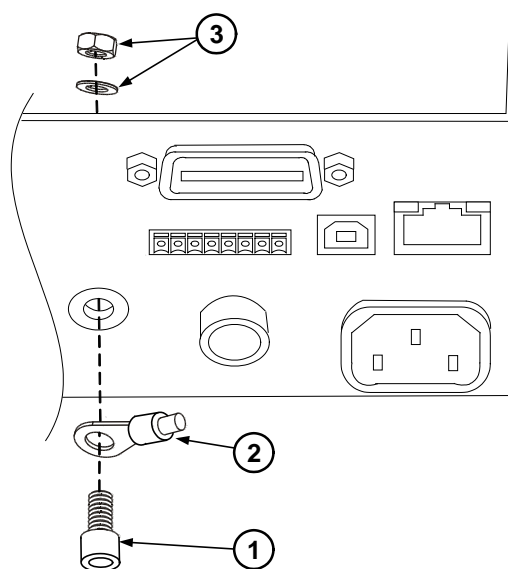



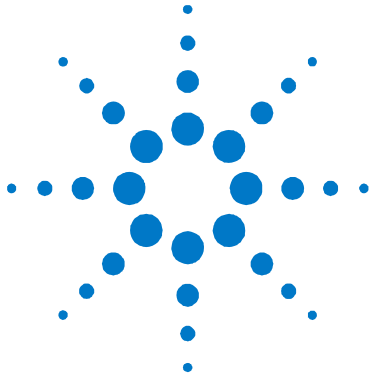

## 5 Troubleshooting

<a href="#">Preliminary Checkout</a> .....	42
<a href="#">Overall Troubleshooting</a> .....	43
<a href="#">Front Panel Troubleshooting</a> .....	46
<a href="#">Bias Board Troubleshooting</a> .....	46
<a href="#">Backplane Board Troubleshooting</a> .....	47
<a href="#">Power Module Troubleshooting</a> .....	48
<a href="#">Calibration and Passwords</a> .....	50
<a href="#">Initialization</a> .....	50

Before performing the Overall Troubleshooting procedures, perform the Preliminary Checkout procedure in the beginning of this chapter.

If the solar array simulator passes selftest and there are no obvious faults, perform the verification procedures in chapter 2 to determine if any output modules are not calibrated, or are not operating properly. This will help isolate a problem to a specific output module.

The following table documents the test equipment required for troubleshooting Agilent E4360 SAS mainframes.

<b>Model</b>	<b>Description</b>
Agilent 34401A or equivalent	Digital multimeter (for measuring voltage and resistance)

## Preliminary Checkout

### Is the instrument inoperative?

- Verify that the AC power cord is connected to the instrument.
- Verify that the front-panel On/Standby switch has been pushed.

### Is the display working?

- If the display is hard to read, but front-panel LED is lit and the fans are working, the display contrast setting may be too light or too dark. Use the front panel menu to set the display contrast.

### Does the instrument fail selftest?

- Remove all external connections to the instrument.
- Check that modules are installed next to each other, starting with slot 1. If there are any empty slots (or filler modules) *between* the output modules, the solar array simulator will not operate.
- Check that the mainframe has the latest firmware installed.
- Turn off the unit and cycle power to run selftest again.

If the supply passes selftest and there are no obvious faults, perform the verification procedures in chapter 2 to determine if any functions are not calibrated, or are not operating properly.

## Selftest Error List

The following table documents the selftest error messages. Refer to Appendix A for other error messages.

<b>Selftest Errors</b> (these errors set Standard Event Status register bit #3)	
202	<b>Thermistor Failed &lt;chan&gt;</b> The internal temperature thermistor has failed. <chan> is the channel location of the failure.
202	<b>Mass Storage Error</b> The user table flash memory is not initialized. This can occur if the table flash memory has been cleared or sanitized. Use SYST:MMEM:INIT to restore the table flash memory.

# Overall Troubleshooting

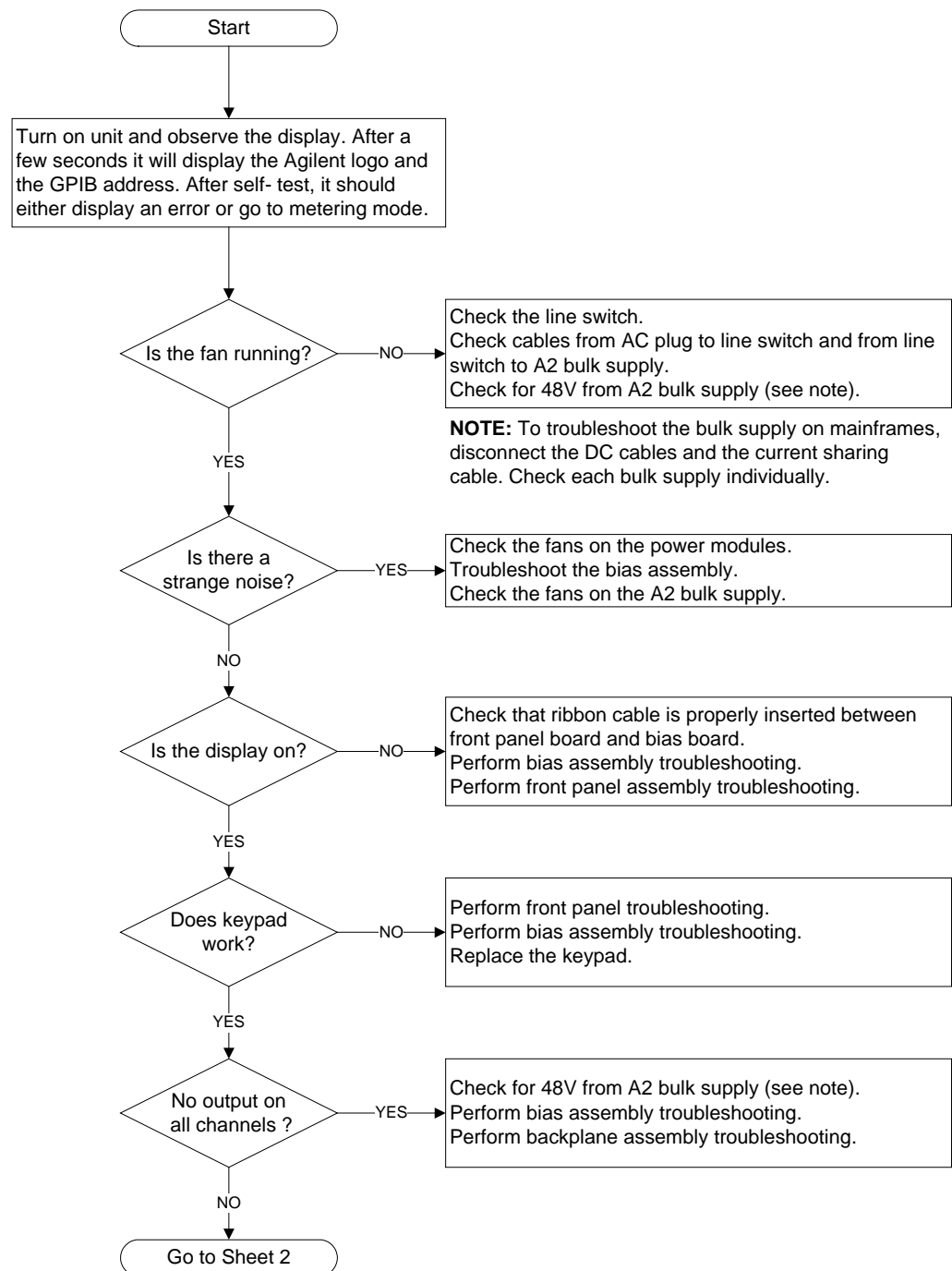

Overall Troubleshooting Sheet 1

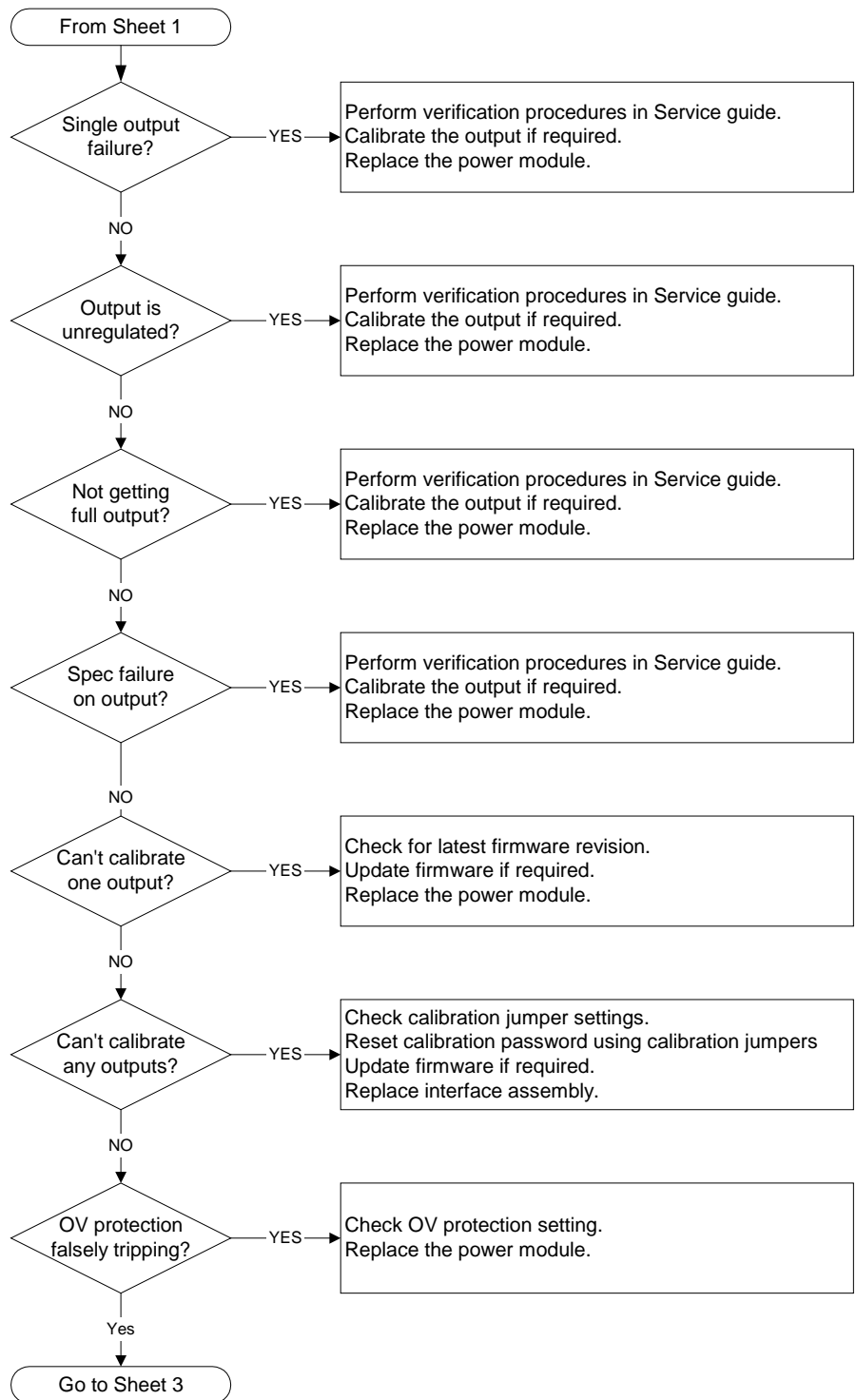

**Overall Troubleshooting Sheet 2**

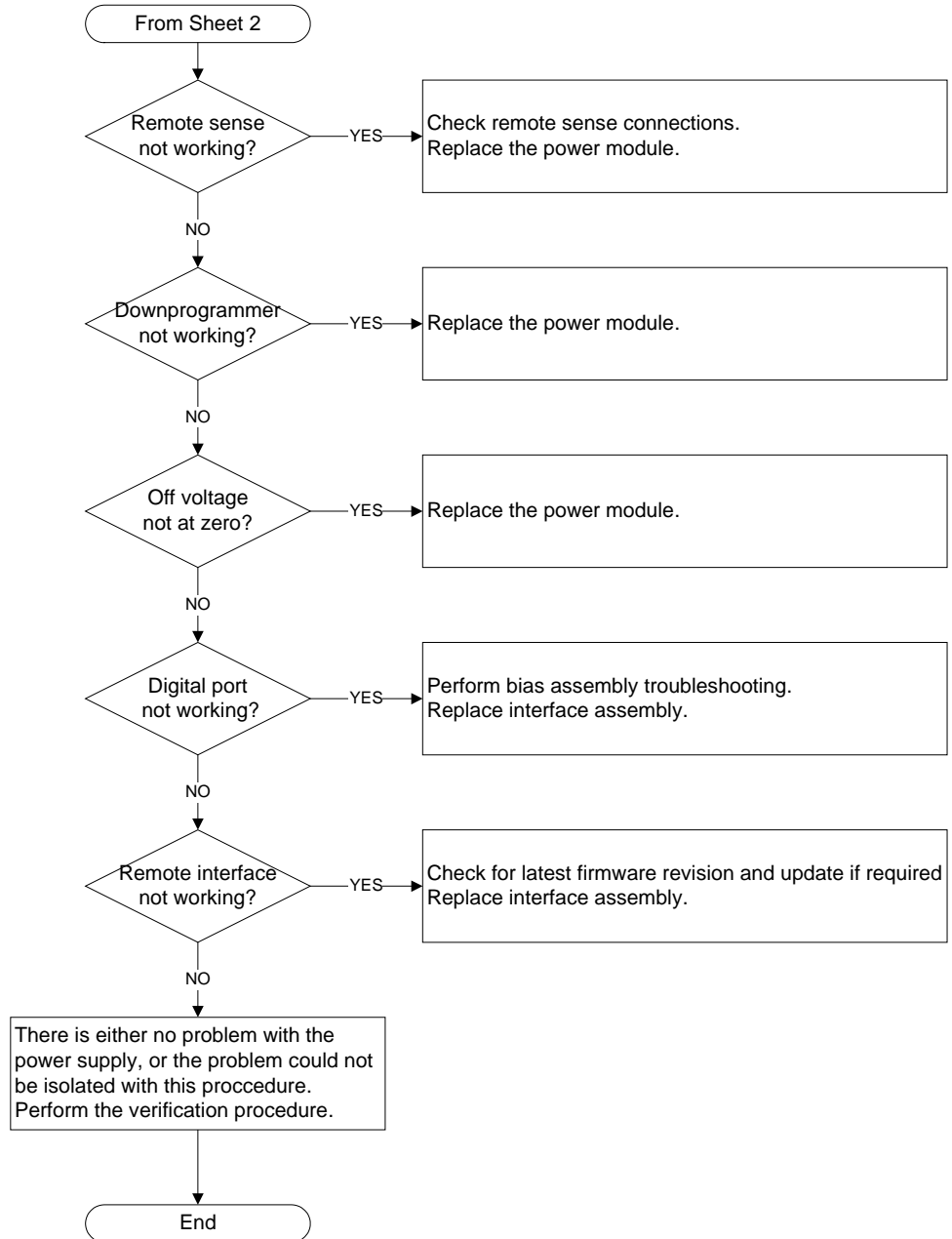

**Overall Troubleshooting Sheet 3**

## Front Panel Troubleshooting

Troubleshooting the front panel board involves checking for the presence of the correct bias voltages on the board. Refer to the following table and figure.

Test Point	Location	Voltage	Action
TP 1	BKL_VCC	+12 V	If bias not present, troubleshoot the bias board or replace the front panel board.
TP 2	P1 pin 3	+12 V	If backlight voltage not present, replace the front panel board. If voltage is present and the display is not lit, replace the display.
Common	GNDB	Common	

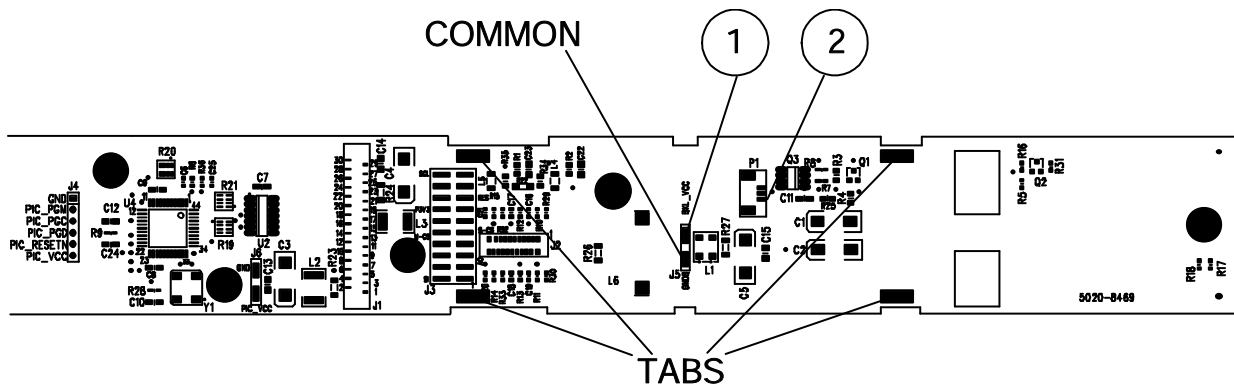

## Bias Board Troubleshooting

Troubleshooting the bias board involves checking for the presence of the correct bias voltages on the board. Refer to the following table and figures.

Note that if the bias voltages at test points 2 - 4 in the following table are not present, it could be caused by a defect in the output module or interface board that is pulling the bias voltage low.

Test Point	Location	Voltage	Action
TP 1	+ RED	+48 V	Output of bulk supply. If not present, replace the bulk supply.
TP 2	+ C4	+12 V	If biases at TP 2, TP 3, or TP 4 are not present, disconnect the backplane and interface board cable assemblies and recheck. If biases are still not present, replace the bias board.
TP 3	U9 - 2	+5 V	Same as above.
TP 4	+ C3	+3.3 V	Same as above.
Common	- BLK	Common	

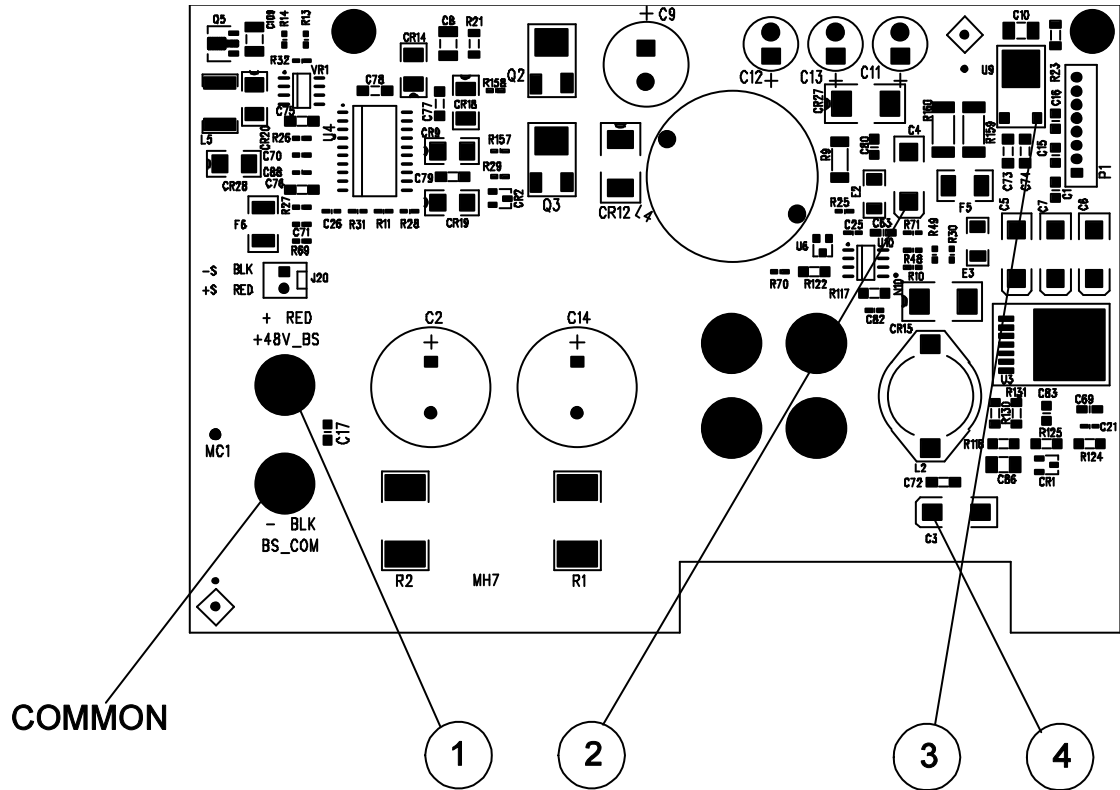

## Backplane Board Troubleshooting

Troubleshooting the backplane board consists of visually inspecting the pins and pin connections.

If there are missing or broken pins, replace the board.

If there are bent pins, carefully try to straighten the pin. If you are unsuccessful, replace the board.

Closely examine the solder connections at the pins. If there are cracks in the solder, carefully re-solder the connector. If unsuccessful, replace the board.

## Power Module Troubleshooting

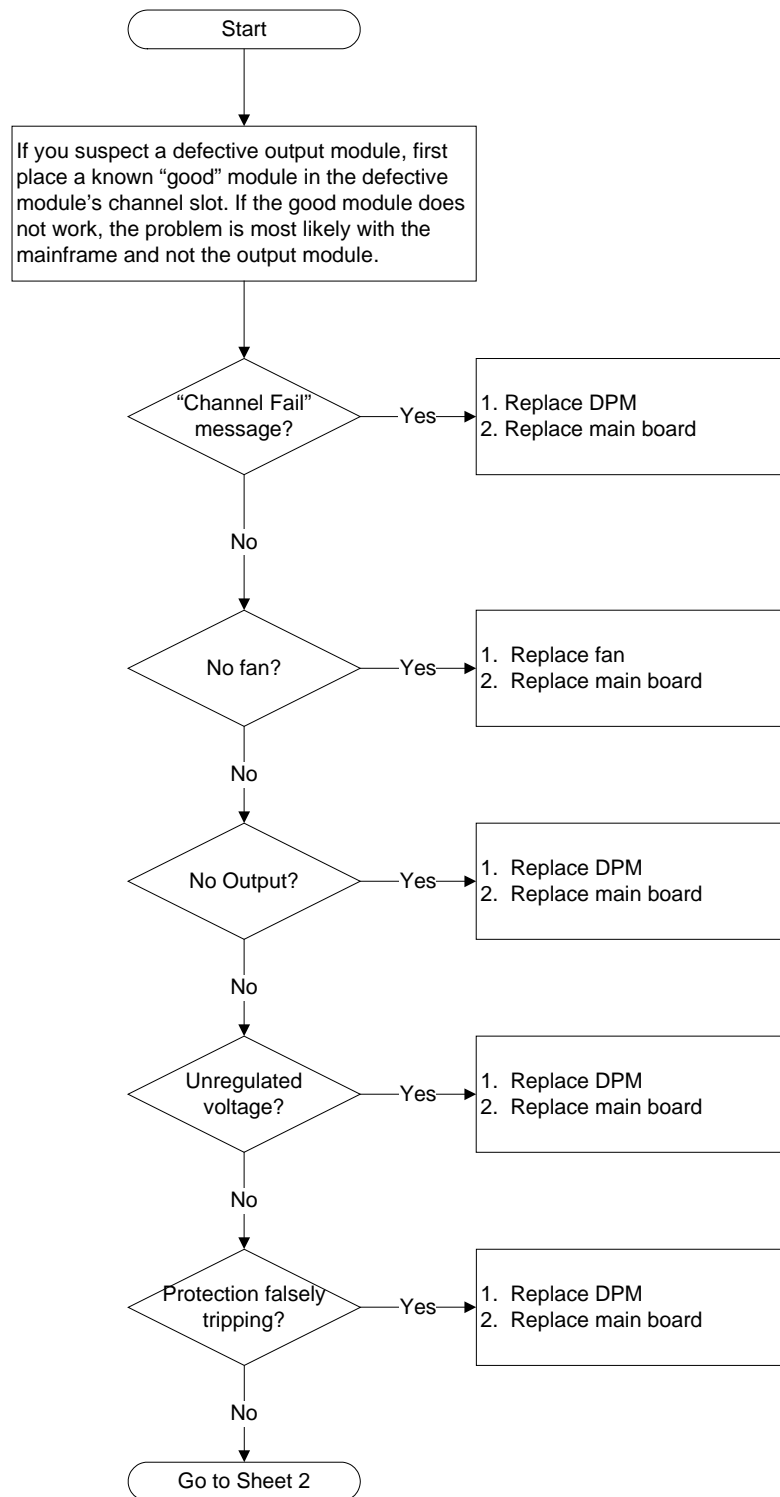

Power Module Troubleshooting Sheet 1

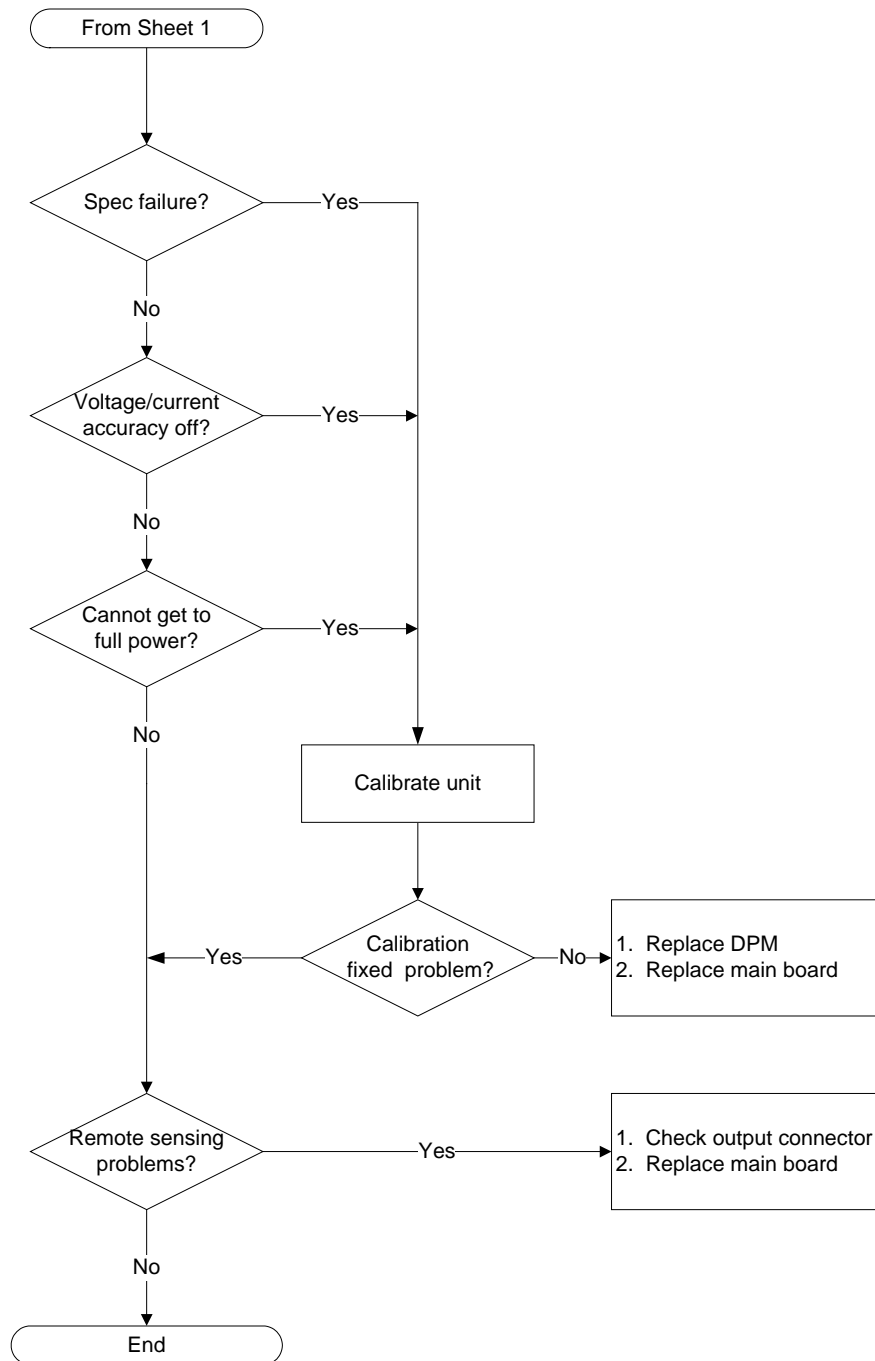

**Power Module Troubleshooting Sheet 2**

## Calibration and Passwords

Calibration is not required after the mainframe has been repaired. All calibration information is module-specific and resides in each output module.

However, if the A6 board that contains the calibration switches has been replaced, any calibration password that has been set will be lost. Passwords that are used to prevent access to the front panel Admin menu will also be lost.

The calibration password will automatically be reset to the factory default, which is zero (0). Front panel access to the Admin menu will be unrestricted unless a password is set.

Refer to the User's Guide for information on setting the calibration password as well as the Admin menu password.

## Initialization

The solar array simulator's model number, serial number, and other constants that are required to program the instrument are stored in an EEPROM on the A6 board. If this board is replaced, the instrument must be re-initialized.

To initialize the solar array simulator, you must send the following information to the solar array simulator over the interface:

```
DIAGnostic:FRAMe:ATTRibute "ModelNumber", "value"
```

where "value" is the model number, e.g. E4360B.

```
DIAGnostic:FRAMe:ATTRibute "SerialNumber", "value"
```

where "value" is the serial number located on top of the interface cover.

At power-up, the solar array simulator will go through the turn-on self test sequence. All other parameters will be set to the factory defaults. The mainframe is now initialized.

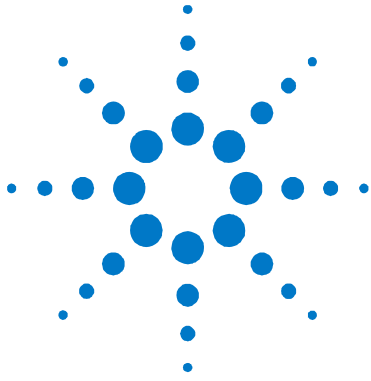

## 6 Replaceable Parts

<a href="#">E4360A Mainframe Parts List</a> .....	52
<a href="#">E4360A Mainframe Parts Location Diagram</a> .....	53
<a href="#">E4361A/E4362A Parts List</a> .....	54
<a href="#">E4361A/E4362A Parts Location Diagram</a> .....	54

The following table documents the replaceable parts assemblies. The diagrams show the location of the parts

## E4360A Mainframe Parts List

Reference Designator	Part number	Description
<b>Electrical Assemblies</b>		
A1	E4360-60103	A1 Front Panel PCA (tested)
A2	0950-4687 (qty. 2)	A2 Bulk Supply
A3	5067-2600	A3 Backplane PCA
A4	5067-2575	A4 Interconnect PCA (with cable assemblies)
A5	5067-4301	A5 Bias PCA
A6	E4360-60102	A6 Interface PCA (tested)
<b>Individual Parts</b>		
1	5002-2872	Chassis frame
2	5002-2873	Front frame
3	1390-1079 (qty. 4)	Front handles
4	N6700-40001	Keypad
5	2090-0886	Display
6	4040-2556	Window
7	N6700-00001	Front panel
8	3101-4019	Line switch
9	5188-4205	AC cable, line switch to bulk supplies
10	5188-4207	Current share cable, bulk supply to bulk supply
11	5185-1358 (qty. 2)	Cable, bulk supply to ground
12	5185-1354	Ribbon cable, to front panel
13	5188-4236	Bias cable assembly to backplane
14	5185-8865	AC cable, ac line filter to line switch
15	5185-8864	Ribbon cable, to backplane
16	5188-4219	Bias cable assembly to interface board
17	5063-9208	Strap handle
18	E6601-21033	Handle retainer
19	E4400-40018	End cap
20	5188-4226	AC line filter
21	5185-8809	AC cable assembly with ferrite core
22	5185-8866	AC cable, socket to line filter (1 wire)
23	1253-7050	AC input socket
24	E5810-61605	GPIB connector with cable
25	1253-6408	Digital plug
26	1510-0038	Binding post
<b>Covers and Labels</b>		
27	5002-2880	RFI cover
	5002-2878	Bulk supply cover
	5002-2876	Blower cover
	5002-2877	Interface cover
	E4360-80001	Front/Rear/Interface labels

### E4360A Mainframe Parts Location Diagram

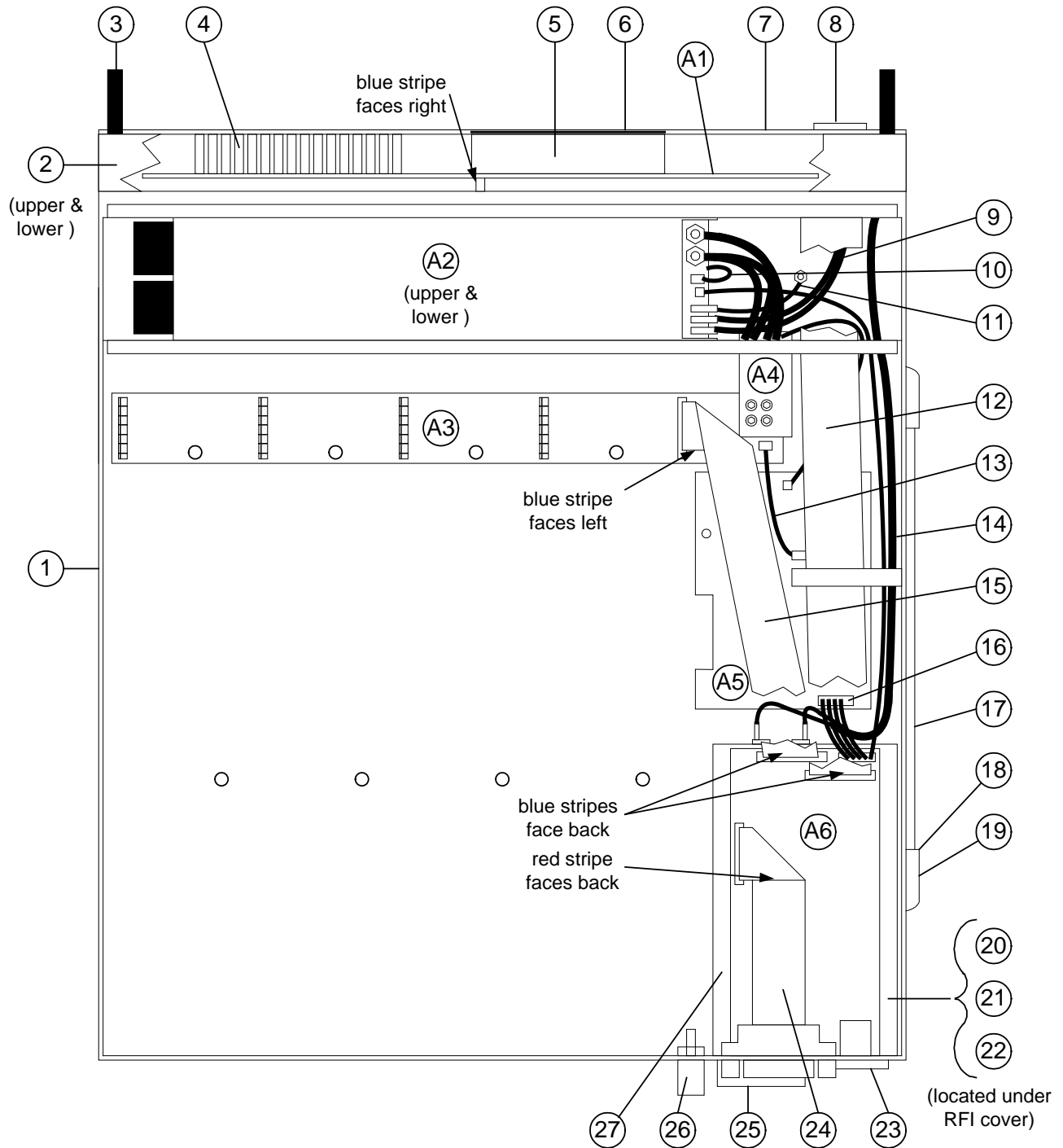

## E4361A/E4362A Parts List

Reference Designator	Part number	Description
	5002-2875	Top cover
	E4361-80001	E4361A Label
	E4362-80001	E4362A Label
	5185-8869	Bottom insulator paper
	5185-8870	Top insulator paper
1	5002-2874	Chassis - base
2	5065-7091	Fan - circuit board
3	5002-2879	Fan bracket
4	5182-9006	Thermal cable
5	E4360-20001	Heatsink
6	06611-40006	Fan spacer (3)
7	5067-2577	Fan – on heatsink
A1 – E4361A	E4361-60102	A1 main board PCA (tested)
A1 – E4361A J01	E4361-60002	A1 main board PCA (tested)
A1 – E4361A J02	E4361-60103	A1 main board PCA (tested)
A1 – E4362A	E4362-60102	A1 main board PCA (tested)
A1 – E4362A J01	E4362-60105	A1 main board PCA (tested)
A1 – E4362A J02	E4362-60106	A1 main board PCA (tested)
A1 – E4362A J03	E4362-60107	A1 main board PCA (tested)
A1 – E4362A J04	E4362-60109	A1 main board PCA (tested)
A1 – E4362A J05	E4362-60111	A1 main board PCA (tested)
A2	E4360-60101	A2 DPMM PCA (tested)

## E4361A/E4362A Parts Location Diagram

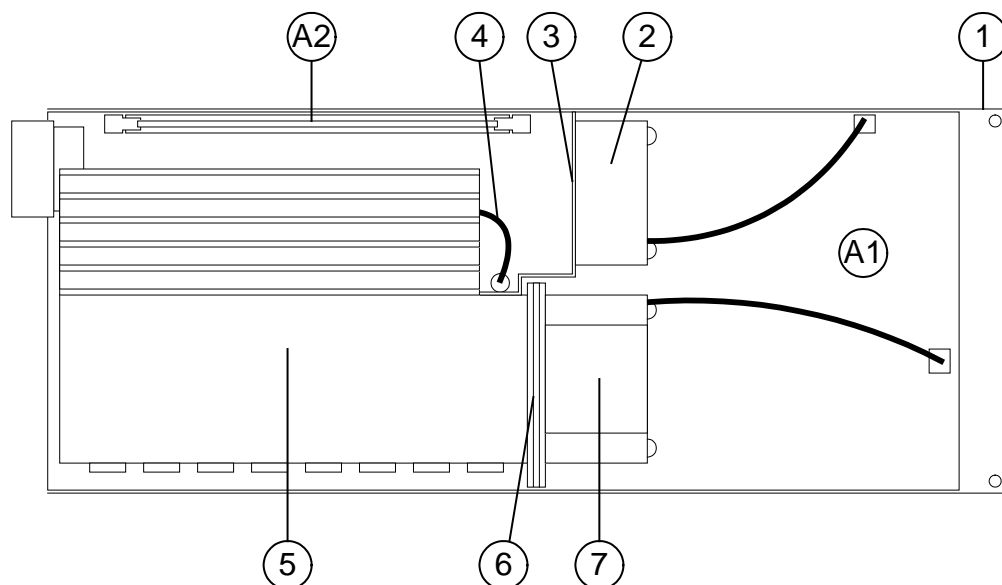

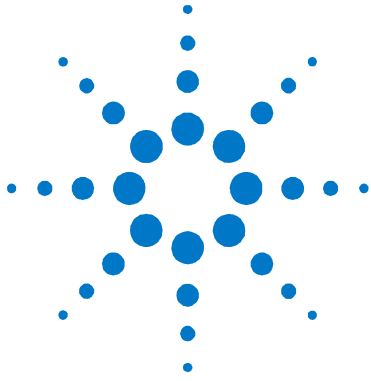

## Appendix A Error Messages

<a href="#">Displaying Error Messages</a> .....	56
<a href="#">Error List</a> .....	56

This appendix gives the error numbers and descriptions that are returned by the Agilent E4360 Series Solar Array Simulator.

Error messages can be displayed on the front panel and also read back programmatically.

## Displaying Error Messages

The instrument beeps each time a command syntax or hardware error is generated. The front-panel **ERR** annunciator turns on when one or more errors are currently stored in the SCPI error queue.

Front Panel:	SCPI Command:
Press the Error key.	SYST:ERR?
If errors appear, use the navigation keys to scroll through the list.	

Errors are cleared as they are read. When all errors have been read, the **ERR** annunciator turns off and the error queue is cleared.

## Error List

Error	Device-dependent Errors (these errors set Standard Event Status register bit #3)
0	<b>No error</b> This is the response to the ERR? query when there are no errors.
100	<b>Too many channels</b> You have specified more channels than are installed in the mainframe.
101	<b>Calibration state is off</b> Calibration is not enabled. The instrument will not accept calibration commands.
102	<b>Calibration password is incorrect</b> The calibration password is incorrect.
103	<b>Calibration is inhibited by switch setting</b> Calibration mode is locked out by the calibration switch.
104	<b>Bad sequence of calibration commands</b> Calibration commands have not been entered in the proper sequence.
105	<b>Unexpected output current</b> The measured output current is outside the acceptable range.
106	<b>Zero measurement out of range error</b> The "zero" measurement value is outside the acceptable range.
107	<b>Programming cal constants out of range</b> The programmed calibration constant is outside the acceptable range.
108	<b>Measurement cal constants out of range</b> The measurement calibration constant is outside the acceptable range.
109	<b>Over voltage cal constants out of range</b> The over voltage calibration constant is outside the acceptable range.
110	<b>Wrong V+I</b> The instrument was unable to set the correct voltage or current value.
111	<b>Aux vloc cal constants out of range</b> Calibration constants on the internal auxiliary local ADC are outside the acceptable range.
112	<b>Aux vrem cal constants out of range</b> Calibration constants on the internal auxiliary remote ADC are outside the acceptable range.
113	<b>Aux imon cal constants out of range</b> Calibration constants on the internal auxiliary imon ADC are outside the acceptable range.

---

<b>Device-dependent Errors (continued)</b>	
114	<b>Wrong status</b> The wrong status was reported. Instrument was expected to be in either CV or CC mode.
116	<b>Locked out by internal switch setting</b> Calibration mode is locked out by the calibration switch. Refer to the Service Guide.
117	<b>Calibration Error</b> An error occurred during calibration. Exit calibration mode and do not save calibration settings.
118	<b>Must be in Fixed mode to calibrate</b> The instrument must be set to Fixed mode operation before it can be calibrated.
200	<b>Hardware error channel &lt;channel&gt;</b> A hardware error has occurred on the specified channel.
201	<b>Invalid configuration, empty slots</b> There is an empty slot between modules. This configuration is not allowed.
202	<b>Selftest Fail</b> A selftest failure has occurred. See selftest failure list for details.
204	<b>NVRAM checksum error</b> A checksum error has occurred in the instrument's nonvolatile random access memory.
205	<b>NVRAM full</b> The nonvolatile random access memory of the instrument is full.
206	<b>File not found</b> The internal calibration file or the internal channel attribute file was not found in NVRAM.
207	<b>Cal file version error</b> The calibration file was written or read using old firmware. Firmware must be updated.
208	<b>Running backup firmware</b> Backup firmware is running because something is wrong with the primary firmware. Firmware must be updated.
209	<b>Modules do not match group NV config</b> A module has been replaced in the mainframe that does not match the characteristics required for it to be a grouped module.
210	<b>Frame NVRAM error</b> An error has occurred in the mainframe's nonvolatile random access memory.
302	<b>Option not installed</b> The option that is programmed by this command is not installed.
303	<b>There is not a valid acquisition to fetch from</b> There is no valid data in the measurement buffer.
304	<b>Volt and curr in incompatible transient modes</b> Voltage and current cannot be in Step and List mode at the same time.
305	<b>A triggered value is on a different range</b> A triggered value is on a different range than the one that is presently set.
306	<b>Too many list points</b> Too many list points have been specified.
307	<b>List lengths are not equivalent</b> One or more lists are not the same length.
308	<b>This setting cannot be changed while transient trigger is initiated</b> Setting cannot be changed while the instrument is waiting for or executing a trigger sequence.
309	<b>Cannot initiate, voltage and current in fixed mode</b> Cannot initiate the transient generator because either the voltage or the current function is set to Fixed mode. Transient triggering is not available in Fixed mode.

---

<b>Device-dependent Errors</b> (continued)	
311	<b>This group of channels has non-identical features</b> The characteristics of the modules that have been selected to be grouped do not match.
312	<b>The command is disabled when the channel is grouped</b> The command is disabled when the channel is grouped. Ungroup the channel to use command.
313	<b>Datalog time interval out of range</b> The datalog time interval is set to a value that is outside the allowable range.
315	<b>Settings conflict error</b> There is a settings conflict error. For example, the Vmp setting may be greater than the Voc setting. This is not allowed.
316	<b>Mass storage error</b> An error has occurred with the mass storage. For example, the mass storage could be full.
318	<b>Datalog error</b> An error has occurred with the data logger.
320	<b>VMP must be less than VOC</b> The value of the maximum-point voltage must be less than the value of the open-circuit voltage.
321	<b>IMP must be less than or equal to ISC</b> The maximum-point current value must be less than or equal to the short-circuit current value.
322	<b>VMP and/or IMP too small</b> The values of either the maximum-point voltage or the maximum-point current are too small.
323	<b>Can't init unless output in SAS mode with List submode selected</b> The instrument cannot be initialized unless it is set to SAS mode with List mode selected.
324	<b>Cannot change resolution unless in Fixed mode</b> The instrument must be set to Fixed mode operation before the resolution can be changed.
325	<b>Too many table points</b> Too many table points have been specified. The maximum is 4000.
326	<b>Table not found</b> A table with that name has not been found.
327	<b>Cannot de-select table in Table mode</b> The table cannot be de-selected because the instrument is operating in Table mode. Set the instrument to Fixed mode to de-select the table.
328	<b>Calculated open circuit voltage too large</b> The calculated open-circuit voltage exceeds the output voltage rating of the instrument.
329	<b>Exceeds soft limit</b> The programmed value exceeds the soft limit setting.
330	<b>Table error</b> An error has occurred because of one of the table value parameters.
331	<b>Exceeds low-line limit</b> The programmed current exceeds the reduced current that is available when the instrument is operating at low AC line (100 VAC or 120 VAC nominal).
400	<b>Power must be cycled for new settings to take effect</b> Cycle AC power for the new settings to take effect.
401	<b>IO settings have been reset to factory defaults. Cycle power for settings to take effect</b> Cycle AC power for the new IO settings to take effect.
402	<b>NVRAM settings have been reset to factory defaults. Cycle power for settings to take effect</b> Cycle AC power for the new NVRAM settings to take effect.
414	<b>Settings conflict warning</b> Settings conflict error. For example, the Vmp setting may be greater than the Voc setting.

---

<b>Command Errors</b> (these errors set Standard Event Status register bit #5)	
-100	<b>Command error</b> Generic syntax error.
-101	<b>Invalid character</b> An invalid character was found in the command string.
-102	<b>Syntax error</b> Invalid syntax was found in the command string. Check for blank spaces.
-103	<b>Invalid separator</b> An invalid separator was found in the command string. Check for proper use of , ; :
-104	<b>Data type error</b> A different data type than the one allowed was found in the command string.
-105	<b>GET not allowed</b> A group execute trigger is not allowed in a command string.
-108	<b>Parameter not allowed</b> More parameters were received than were expected.
-109	<b>Missing parameter</b> Fewer parameters were received than were expected.
-110	<b>Command header error</b> An error was detected in the header.
-111	<b>Header separator error</b> A character that was not a valid header separator was found in the command string.
-112	<b>Program mnemonic too long</b> The header contains more than 12 characters.
-113	<b>Undefined header</b> A command was received that was not valid for this instrument.
-114	<b>Header suffix out of range</b> The value of the numeric suffix is not valid.
-120	<b>Numeric data error</b> Generic numeric data error.
-121	<b>Invalid character in number</b> An invalid character for the data type was found in the command string.
-123	<b>Exponent too large</b> The magnitude of the exponent was larger than 32000.
-124	<b>Too many digits</b> The mantissa of a numeric parameter contained more than 255 digits, excluding leading zeros.
-128	<b>Numeric data not allowed</b> A numeric parameter was received but a character string was expected.
-130	<b>Suffix error</b> Generic suffix error
-131	<b>Invalid suffix</b> A suffix was incorrectly specified for a numeric parameter.
-134	<b>Suffix too long</b> The suffix contains more than 12 characters.
-138	<b>Suffix not allowed</b> A suffix is not supported for this command.
-140	<b>Character data error</b> Generic character data error

---

<b>Command Errors (continued)</b>	
-141	<b>Invalid character data</b> Either the character data element contains an invalid character, or the element is not valid.
-144	<b>Character data too long</b> The character data element contains more than 12 characters.
-148	<b>Character data not allowed</b> A discrete parameter was received, but a string or numeric parameter was expected.
-150	<b>String data error</b> Generic string data error
-151	<b>Invalid string data</b> An invalid character string was received. Check that the string is enclosed in quotation marks.
-158	<b>String data not allowed</b> A character string was received, but is not allowed for this command.
-160	<b>Block data error</b> Generic block data error
-161	<b>Invalid block data</b> The number of data bytes sent does not match the number of bytes specified in the header.
-168	<b>Block data not allowed</b> Data was sent in arbitrary block format but is not allowed for this command.
-170	<b>Expression error</b> Generic expression error
-171	<b>Invalid expression data</b> The expression data element was invalid.
-178	<b>Expression data not allowed</b> Expression data element was sent but is not allowed for this command.
<b>Execution Errors (these errors set Standard Event Status register bit #4)</b>	
-200	<b>Execution error</b> Generic syntax error
-220	<b>Parameter error</b> A data element related error occurred.
-221	<b>Settings conflict</b> A data element could not be executed because of the present instrument state.
-222	<b>Data out of range</b> A data element could not be executed because the value was outside the valid range.
-223	<b>Too much data</b> A data element was received that contains more data than the instrument can handle.
-224	<b>Illegal parameter value</b> An exact value was expected but not received.
-225	<b>Out of memory</b> The device has insufficient memory to perform the requested operation.
-226	<b>Lists not same length</b> One or more lists are not the same length.
-230	<b>Data corrupt or stale</b> Possible invalid data. A new reading was started but not completed.
-231	<b>Data questionable</b> The measurement accuracy is suspect.

<b>Execution Errors</b> (continued)	
-232	<b>Invalid format</b> The data format or structure is inappropriate.
-233	<b>Invalid version</b> The version of the data format is incorrect to the instrument.
-240	<b>Hardware error</b> The command could not be executed because of a hardware problem with the instrument.
-241	<b>Hardware missing</b> The command could not be executed because of missing hardware, such as an option.
-260	<b>Expression error</b> An expression program data element related error occurred.
-261	<b>Math error in expression</b> An expression program data element could not be executed due to a math error.
<b>Query Errors</b> (these errors set Standard Event Status register bit #2)	
-400	<b>Query Error</b> Generic error query
-410	<b>Query INTERRUPTED</b> A condition causing an interrupted query error occurred.
-420	<b>Query UNTERMINATED</b> A condition causing an unterminated query error occurred.
-430	<b>Query DEADLOCKED</b> A condition causing a deadlocked query error occurred.
-440	<b>Query UNTERMINATED after indefinite response</b> A query was received in the same program message after a query indicating an indefinite response was executed.
<b>Selftest Errors</b> (these errors set Standard Event Status register bit #3)	
202	<b>Thermistor Failed &lt;chan&gt;</b> The internal temperature thermistor has failed. <chan> is the channel location of the failure.
202	<b>Mass Storage Error</b> The user table flash memory is not initialized. This can occur if the table flash memory has been cleared or sanitized. Use SYST:MMEM:INIT to restore the table flash memory.



# Index

B		F	
backplane board .....	43	firmware upgrade.....	7
bias board .....	33, 42	flowchart .....	39
bulk supply.....	34	front panel.....	33, 42
C		G	
calibration .....	24	ground	
current programming and measurement.....	26	redundant for 400 Hz.....	35
enable.....	23, 25		
equipment .....	10	H	
password .....	27	history .....	2
post repair .....	46		
save and exit.....	27	I	
switches .....	24, 32	initialization	
voltage programming and measurement .....	25	post repair.....	46
Caution .....	3	installing modules .....	31
CC		instrument	
load effect .....	16	identification .....	6, 7
source effect.....	16, 17	interface board .....	33
contact numbers.....	5		
current		O	
monitoring resistor .....	11	operating checklist.....	6
programming accuracy .....	15	overall troubleshooting.....	39
readback accuracy.....	15		
CV		P	
load effect .....	13	password	
noise.....	14	calibration.....	24
source effect.....	13	post repair.....	46
		preliminary checklist.....	38
D		print date .....	2
disassembly.....	30, 31		
bias board.....	33	R	
bulk supply .....	34	removing modules .....	31
front panel.....	33	repackaging.....	6
interface board .....	33	replaceable parts	
parts location.....	49	location .....	49
ribbon cables .....	30	returning units.....	6
tools.....	30	ribbon cables .....	30
E			
electronic load .....	11	S	
electrostatic discharge precautions .....	6, 30	safety.....	3
error codes.....	52	selftest errors .....	38
displaying .....	52		
selftest.....	38		

