

Operation Manual

ShockLine™

MS46322A/B Series

Economy Vector Network Analyzer

MS46322A-004, 1 MHz to 4 GHz, 2-Port

MS46322A/B-010, 1 MHz to 8 GHz, 2-Port

MS46322A-014, 1 MHz to 14 GHz, 2-Port

MS46322A/B-020, 1 MHz to 20 GHz, 2-Port

MS46322A-030, 1 MHz to 30 GHz, 2-Port

MS46322A/B-040, 1 MHz to 43.5 GHz, 2-Port

MS46322B-043, 1 MHz to 43.5 GHz, 2-Port



Anritsu

Chapter Descriptions

Chapter 1 — Overview

This chapter provides an overview of the ShockLine™ MS46322A/B Series Vector Network Analyzer (VNA). It describes the instrument's major functions and identifies product documentation. It also identifies available precision component kits including mechanical calibration kits and verification kits.

Chapter 2 — Front and Rear Panels

The chapter provides an overview of the MS46322A/B Series VNA hardware user interface including front panel buttons, front panel connectors, and back panel connectors. Included are photographs of the front and rear panels. Each front panel item is described with its function and a cross reference to the menu it activates on the user interface display. Each port and connector is described with its connector type, its function, input/output limits, and a cross-reference to a detailed connector pin-out diagram.

Chapter 3 — Installation

This chapter provides information for the initial inspection and preparation for use of the ShockLine MS46322A/B Series VNA and includes information on instrument installation, required operating environment, power requirements, and initial inspection. After power up, the various power modes are described with general warm-up and calibration time intervals. The preventive maintenance section includes information on cleaning along with preparation for storage or shipment. General set up procedures are provided for remote programming control over Ethernet networks.

Chapter 4 — User Interface Display

The chapter provides orientation to the ShockLine application user interface for the ShockLine MS46322A/B Series VNAs. It also provides general descriptions and procedures for trace graph setup, marker setup, and limit line setup.

Appendix A — Vector Network Analyzer Primer

This chapter describes the basic functions of a Vector Network Analyzer (VNA) and how it measures magnitude and phase characteristics of networks, amplifiers, attenuators, and antennas. Scattering parameters (S-parameters) are defined.

Appendix B — Security and Maintenance

The MS46322B is a secure device and can be moved in and out of the secure facilities as there are no user accessible locations on the MS46322B.

Appendix C — Troubleshooting

This section provides troubleshooting tips when operating the MS46322A/B.

Appendix D — Abbreviation Glossary

This glossary defines the abbreviations and terms that appear on the connectors, hard keys, menus, and buttons of the MS46322A/B Series VNA. In some cases, due to space limitations, multiple abbreviations are used for the same term or the same abbreviation is used with different punctuation.

Table of Contents

Chapter 1 — Overview

1-1 Introduction	1-1
1-2 ShockLine MS46322A/B Series VNA Description	1-1
1-3 ShockLine MS46322A/B Series VNA Models	1-1
1-4 ShockLine MS46322A/B VNA Instrument Control	1-2
Graphical User Interface	1-2
1-5 System Identification and Computer Name	1-2
1-6 Calibration and Verification Kits	1-2
Precision Component and Calibration Kits	1-2
1-7 User Documentation	1-3
Product Information, Compliance, and Safety	1-3
Documentation Conventions	1-3
Instrument Identification	1-3
Instrument Connectors	1-3
User Interface, Menus, and Soft Buttons	1-3
User Interface Navigation	1-3
User Input	1-3

Chapter 2 — Front and Rear Panels

2-1 Chapter Overview	2-1
2-2 Front Panel Components	2-1
2-3 Rear Panel Components and Connectors	2-2

Chapter 3 — Installation

3-1 Introduction	3-1
3-2 Unpacking the Product	3-1
Initial Inspection	3-1
Preparation for Use	3-1
3-3 Operating Environment and Power Requirements	3-2
3-4 Power-On/Power-Off Procedures	3-3
Procedure – Power-On to Standby Mode	3-3
Procedure – Standby Mode to Operate Mode	3-3
Procedure – Power-Off	3-4
3-5 Connecting External Devices	3-5
Connecting an External HDMI Monitor	3-5
Connecting an External Mouse or Keyboard	3-5
Connecting an External Printer	3-6
Connecting Other USB Peripherals	3-6
3-6 Ethernet LAN TCP/IP Setup	3-6
Plug-and-Play Configuration	3-6
Manually Configuring TCP/IP Ethernet LAN Settings	3-6
3-7 Starting the GUI Application	3-8

Table of Contents (Continued)

3-8 Updating ShockLine Software	3-9
Software Installation Procedure	3-9
3-9 Simulation Mode	3-10
3-10 Calibration/Verification Interval	3-12
Chapter 4 — User Interface Display	
4-1 Chapter Overview	4-1
4-2 User Interface Main Screen	4-1
User Interface Control and Display Areas	4-2
Function Access	4-3
4-3 Using the Menu Bar Interface	4-6
Menu Bar Overview	4-6
Menu Bar General Operation	4-6
Menu Bar Drop-down Menus and Commands	4-7
4-4 Icon Toolbar	4-15
Overview	4-15
Using the Icon Toolbar Interface	4-15
Available Icon Functions	4-16
4-5 MAIN Menu and Application Menus	4-24
4-6 Using the Main Menu Interface	4-26
Types of Menus, Menu Buttons, and Menu Toolbars	4-26
Menu Title	4-27
Menu Buttons	4-27
Menu Navigation Buttons	4-27
Menu Buttons	4-27
Read-Only Buttons	4-27
Function Buttons	4-28
Toggle Buttons	4-28
Field Selection Buttons	4-28
Field Toolbars	4-29
Button Selection Icon	4-30
Completion Checkmark Button	4-30
Auto-Return Button Groups	4-31
Completion Checkmark Button	4-32
4-7 Using Dialog Boxes	4-32
Standard Dialog Box Buttons	4-32
4-8 Instrument Status Display Area	4-33
Instrument Status Data	4-33
4-9 Channel Status Display Area	4-34
4-10 Working with Channels	4-35
Channel Menu	4-35

Table of Contents (Continued)

4-11 Working with Traces	4-38
Trace Menu	4-38
Repeat the actions above to return the trace to its normal size.	4-39
Types of Trace Displays	4-39
Trace Data Types	4-39
Trace Display Graphs	4-40
Trace Labels	4-43
Trace Label Abbreviations	4-43
Rectilinear Paired Graphs	4-45
Smith Charts	4-46
Smith Chart with Impedance (Circuit Resistance and Reactance)	4-46
Group Delay Graphs	4-48
Polar Graphs	4-49
4-12 Working with Reference Lines and Reference Position	4-50
4-13 Working with Markers	4-51
4-14 Working with Limit Lines	4-53
4-15 Working with Ripple Limit Lines	4-54
Appendix A — Vector Network Analyzer Primer	
A-1 Appendix Overview	A-1
A-2 General Description	A-1
A-3 Instrument Description	A-2
Source Module	A-2
Test Set Module	A-2
Analyzer Module	A-2
A-4 Network Analyzers	A-3
Scalar Analyzer Comparison	A-3
Vector Network Analyzer Basics	A-4
A-5 Polar Display	A-12
Resistive and Reactive Terms	A-12
A-6 Smith Chart	A-13
Measurement Error Correction	A-13
Appendix B — Security and Maintenance	
B-1 Information Security	B-1
Storage and Memory Overview	B-1
B-2 Maintaining Operating System Integrity	B-1
Antivirus Protection	B-1
Windows Updates	B-2
B-3 Operating System Restore	B-3
Procedure	B-3
B-4 Optional Rack Mount Installation	B-4
B-5 Hard Drive Removal and Installation	B-6
Removal Procedure	B-6
Installation Procedure	B-6

Table of Contents (Continued)

B-6 Preparation for Storage or Shipment	B-7
Preparation for Storage	B-7
Preparation for Shipment	B-7

Appendix C — Troubleshooting

C-1 Introduction	C-1
C-2 Anritsu Hardware is Unavailable	C-1
Restart IVI Server	C-2
Indicator Color Definitions	C-2
C-3 Driver Initialization Error	C-3
C-4 Application Launch Failure	C-3
C-5 EEPROM Does Not Match (Firmware Update)	C-3
C-6 Updating EEPROM Unsuccessful (Firmware Update Failed)	C-4
C-7 Updating Firmware Manually	C-5
C-8 Printout Does Not Capture the Entire ShockLine Screen	C-6
C-9 Running ShockLine as Non-administrator	C-7

Appendix D — Abbreviation Glossary

D-1 Appendix Overview	D-1
D-2 Glossary	D-1

Subject Index

Chapter 1 — Overview

1-1 Introduction

This chapter provides an overview of the ShockLine™ MS46322A/B Series Vector Network Analyzer (VNA). It describes the instrument's major functions and identifies product documentation. It also identifies available precision component kits including mechanical calibration kits and verification kits.

1-2 ShockLine MS46322A/B Series VNA Description

The ShockLine MS46322A/B Series VNA is an instrument system that contains a built-in source, test set, and analyzer. Designed for manufacturing applications, the MS46322A/B series VNA supports remote test programming through LAN communications. Test results can be displayed real time on an external video monitor. Screen captures can easily be printed or saved in common graphic file formats.

The ShockLine MS46322A/B Series VNA provides a maximum frequency range from 1 MHz to 43.5 GHz. The ShockLine MS46322A/B Series VNA has up to 16,001 total test points available with up to 16 trace display graphs. Each trace can have up to 12 standard markers and one reference marker.



Figure 1-1. ShockLine VNA Front Panel

1-3 ShockLine MS46322A/B Series VNA Models

Table 1-1 lists the seven basic models:

Table 1-1. ShockLine MS46322A/B Series VNA Models

VNA Model Number	Name	Specifications	Test Port Connectors
MS46322A-004	Economy Vector Network Analyzer	1 MHz to 4 GHz	N(f) Connector Test Ports (2)
MS46322A/B-010	Economy Vector Network Analyzer	1 MHz to 8 GHz	N(f) Connector Test Ports (2)
MS46322A-014	Economy Vector Network Analyzer	1 MHz to 14 GHz	K(m) Connector Test Ports (2)
MS46322A/B-020	Economy Vector Network Analyzer	1 MHz to 20 GHz	K(m) Connector Test Ports (2)
MS46322A-030	Economy Vector Network Analyzer	1 MHz to 30 GHz	K(m) Connector Test Ports (2)
MS46322A/B-040	Economy Vector Network Analyzer	1 MHz to 43.5 GHz	K(m) Connector Test Ports (2)
MS46322B-043	Economy Vector Network Analyzer	1 MHz to 43.5 GHz	Extended-K™(m) Connector Test Ports (2)

1-4 ShockLine MS46322A/B VNA Instrument Control

The VNA can be controlled either through the ShockLine application software's graphical user interface GUI or by program commands over an Ethernet LAN. ShockLine automatically runs when the instrument is first powered on. ShockLine use requires a video monitor, USB keyboard, and USB mouse or touchscreen to control the VNA. When the video monitor is used, the main user controls are on-screen. There are no other user controls on the front panel aside from the main power switch and its indicators.

Note

When operating the VNA through remote programming, the graphical user interface and controls are disabled. To return to local front panel control, press the keyboard **Esc** key, or send the **RTL** command. For more information about remote programming, refer to the **ShockLine MS46322A/B Series VNA Programming Manual**.

The ShockLine MS46322A/B Series VNA **does not** support Microsoft® Remote Desktop interface.

The ShockLine MS46322A/B Series VNA is equipped with an internal non-volatile memory for storing and recalling operating and calibration setups, along with measurement information and data.

Graphical User Interface

The graphical user interface (GUI) provides a combination of a menu command bar, icon task bar, and right-side navigation menu for most system functions. All of the on-screen navigation elements can be accessed by the attached USB mouse/keyboard and display.

1-5 System Identification and Computer Name

All Anritsu instruments are assigned a unique six-digit identification (ID) number such as "080101." This number is affixed to a decal on the back panel of each unit. Please use this number in any correspondence with Anritsu Customer Service.

1-6 Calibration and Verification Kits

Precision Component and Calibration Kits

Two types of precision-component kits are available: calibration and verification. Calibration kits contain components used to identify and separate error sources inherent in microwave test setups. Verification kits consist of components with characteristics traceable to the National Institute of Standards and Technology (NIST) and are used as the most dependable means of checking system accuracy. Each of these kits contains a floppy disk and/or a USB memory device that provides coefficient, characterization, or measurement data for each component. Refer to the instrument data sheet for detailed specifications on automatic calibrators, mechanical calibration kits, and verification kits.

Mechanical Calibration Kits

The mechanical calibration kits provide 50 ohm calibrations for N or K devices.

Verification Kits

Verification kits can be used with the provided software and data to verify the calibration and resulting performance of the ShockLine MS46322A/B Series VNA. The applicable calibrations are Short-Open-Load-Thru (SOLT) using the Mechanical Cal kits.

1-7 User Documentation

The following ShockLine MS46322A/B Series Vector Network Analyzers documentation and product updates are available on the Anritsu web site at: <http://www.anritsu.com>.

Product Information, Compliance, and Safety

- ShockLine Product Information, Compliance, and Safety (PICS) – 10100-00067

ShockLine Vector Network Analyzers

- MS46322A/B Series VNA ShockLine Operation Manual – 10410-00335
- MS46122A/B-MS46322A/B Series VNA ShockLine Measurement Guide – 10410-00336
- MS46121A/B, MS46122A/B, MS46131A, MS46322A/B Series VNA ShockLine User Interface Reference Manual – 10410-00337
- ShockLine Programming Manual – 10410-00746
- MS46322A Series VNA ShockLine Technical Data Sheet – 11410-00751
- MS46322B Series VNA ShockLine Technical Data Sheet – 11410-00996

Documentation Conventions

The following conventions are used throughout the entire MS46322A/B Series VNA documentation set:

Instrument Identification

Throughout this manual, the following term definitions are used:

- ShockLine VNA refers to any ShockLine VNA module or system.
- VNA refers to any ShockLine VNA module.
- MS46322A/B Series VNA refers to any of the VNAs in the MS46322A/B family.
- When required to identify a specific VNA model, the specific model number is used, such as MS46322A/B-010.

Note

Many of the images in this document are used as typical representations of the product or of the product features. Your instrument and instrument displays may vary slightly from these images.

Instrument Connectors

Panel connectors are denoted with a bold Sans Serif font such as **10 MHZ IN**.

User Interface, Menus, and Soft Buttons

The ShockLine MS46322A/B Series VNA user interface consists of menus, button lists, sub-menus, toolbars, and dialog boxes. All of these elements are denoted with a special font. Generally, the top level menu items are denoted with a Sans Serif font and capitals, and the subordinate items are denoted with a regular Sans Serif font, such as **Frequency** menu button.

User Interface Navigation

Elements in navigation shortcuts or paths are separated with the pipe symbol (“|”). Menu and dialog box names are distinctive Sans Serif font in CAPITALS. Button names are in Title Case. For example, the path to the Manual Cal menu is:

- MAIN | Calibration | CALIBRATION | Calibrate | CALIBRATE | Manual Cal | MANUAL CAL

User Input

User input such as entering values or other information is denoted in a mono-spaced font such as:

`This font denotes a string of user input.`

Chapter 2 — Front and Rear Panels

2-1 Chapter Overview

The chapter provides an overview of the MS46322A/B Series VNA hardware user interface including front panel buttons, front panel connectors, and back panel connectors. Included are photographs of the front and rear panels. Each front panel item is described with its function and a cross reference to the menu it activates on the user interface display. Each port and connector is described with its connector type, its function, input/output limits, and a cross-reference to a detailed connector pin-out diagram.

2-2 Front Panel Components

The MS46322A/B Series VNA front panel and port connectors are identified below in [Figure 2-1](#).

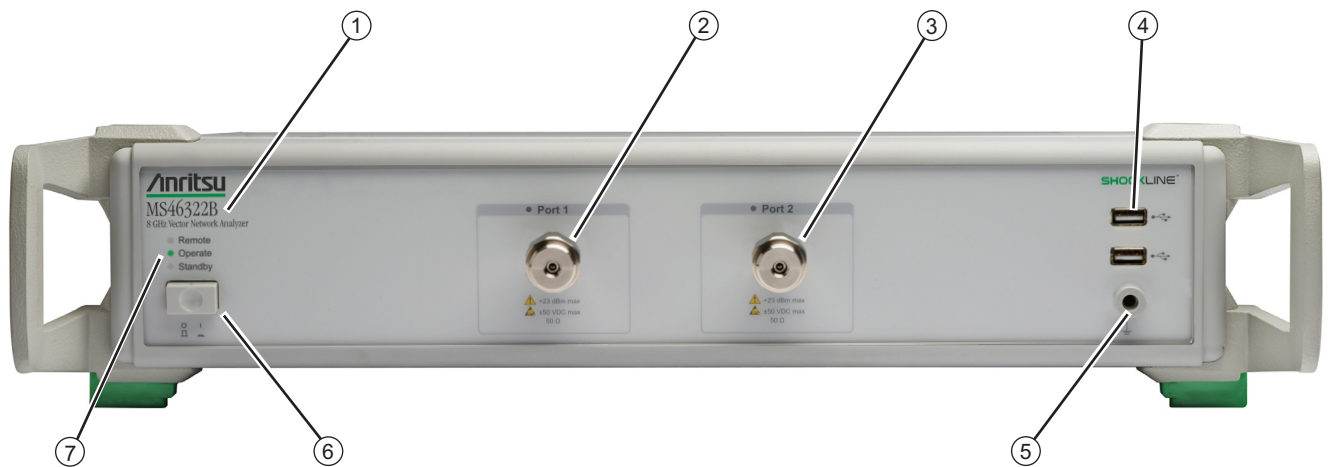

1. ID Plate – Instrument model number identification	5. Chassis Ground Port Banana connector
2. Test Port 1 – K(f) or N(f) depending on freq. of model	6. Remote, Operate, Standby Push Button
3. Test Port 2 – K(f) or N(f) depending on freq. of model	7. Remote, Operate, Standby status indicator LEDs
4. USB Ports – USB 2.0 Type A Ports (2)	

Figure 2-1. MS46322A/B VNA Front Panel Components

2-3 Rear Panel Components and Connectors

The MS46322A/B Series VNA rear panel connectors are shown below [Figure 2-2, “MS46322A/B Series VNA Rear Panel Components”](#) which provides identification of each connector and port.

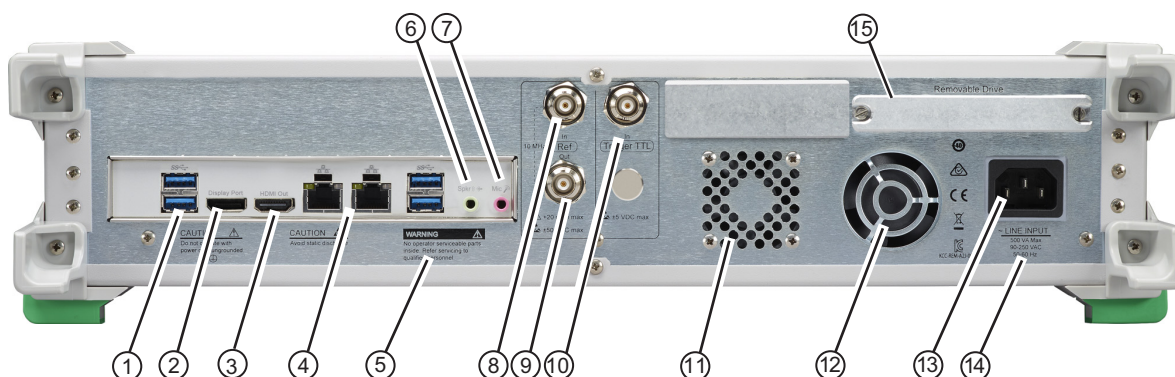

All ports and controls are standard and equipped on all models unless otherwise noted.

1. HDMI Out.
2. USB 2.0 Type A Ports (2): USB connection ports for computer peripheral devices such as a printer, keyboard, or mouse.
3. USB 3.0 Type A Ports(2) : USB connection ports for additional computer peripherals.
4. No operator serviceable parts warning label.
5. Gigabit Ethernet Port: RJ-45 LAN Port.
6. Speaker Output Banana Jack
7. Mic input Banana Jack

8. 10 MHz Reference: 10 MHz In BNC (f) Signal: +0 dBm, typical Nominal 50 ohms, Auto-sensing, better than 10 ppm frequency accuracy recommended.
9. 10 MHz Out BNC (f).
10. Ext. Trigger BNC (f) – External Trigger Input.
11. Inflow Ventilation Fan and Grill.
12. Power Supply Ventilation Fan.
13. AC Input Port.
14. Line Input AC Voltage Parameters.
15. Removable System Drive

Figure 2-2. MS46322A/B Series VNA Rear Panel Components

Chapter 3 — Installation

3-1 Introduction

This chapter provides information for the initial inspection and preparation for use of the ShockLine MS46322A/B Series VNA and includes information on instrument installation, required operating environment, power requirements, and initial inspection. After power up, the various power modes are described with general warm-up and calibration time intervals. The preventive maintenance section includes information on cleaning along with preparation for storage or shipment. General set up procedures are provided for remote programming control over Ethernet networks.

3-2 Unpacking the Product

Initial Inspection

Inspect the shipping container for damage. If the container or cushioning material is damaged, retain until the contents of the shipment have been checked against the packing list and the instrument has been checked for mechanical and electrical operation. If the ShockLine MS46322A/B Series VNA is physically damaged, notify your local sales representative or Anritsu Customer Service. If either the shipping container is damaged or the cushioning material shows signs of stress, notify the carrier as well as Anritsu. Keep the shipping materials for the carrier's inspection.

Preparation for Use

The MS46322A/B ShockLine operating software comes preloaded in the internal hard disk of the VNA. To interface with the ShockLine MS46322A/B Series VNA through direct manual control, a keyboard, mouse, monitor or touchscreen, and interfacing cables are required. For more information on connecting the external peripherals to the MS46322A/B VNA, see [Section 3-5 “Connecting External Devices” on page 3-5](#).

3-3 Operating Environment and Power Requirements

Before installing the ShockLine MS46322A/B Series VNA in its operating environment, ensure that all airflow passages at the sides and rear of the instrument are clear. Proper ventilation is of particular importance whenever the unit is being rack mounted. Keep the cooling fan filters clean so that the ventilation holes are not obstructed. A blocked fan filter can cause the instrument to overheat and shut down. Ensure that the instrument is not exposed to water. The ShockLine MS46322A/B Series VNA can be operated within the following environmental limits:

Table 3-1. Operational Environmental and Power Requirements

Parameter	Specification
Environmental Requirements (per MIL-PRF-28800F; class 3)	
Operating Temperature Range:	0 to +50 degrees Celsius
Relative Humidity:	5 % to 95 % at +30 degrees Celsius, non-condensing
Power Requirements	
Voltages:	90 to 264 VAC maximum (single phase)
Frequency:	47 to 63 Hz
Power:	350 VA maximum (power factor controlled)
Installation Category:	The ShockLine MS46322A/B Series VNA is intended for Installation Category (Overvoltage Category) II

Warning



or



When supplying power to this equipment, connect the accessory 3-pin power cord to a 3-pin grounded power outlet. If required, ground the instrument chassis to a suitable earth ground. If power is supplied without grounding the equipment, there is a risk of receiving a severe or fatal electric shock.

3-4 Power-On/Power-Off Procedures

The power-on procedure involves connecting the instrument to AC Mains, using the front panel **AC Power** switch to turn the instrument on, and then using the instrument software to toggle the instrument into operate mode. The power-off procedure involves using the front panel **AC Power** switch to turn the instrument off.

Note

Do not unplug the instrument when it is in operate mode. Doing so may cause the Windows[®] application to improperly close. **Do not** shut down Windows from the Start menu as this will not properly power off the instrument. Switching the power off from the front panel causes the computer to shut down Windows and properly power off the instrument.



1. IEC C14 Chassis AC Power Socket

Figure 3-1. Rear Panel Power Connection to AC Mains Power

Procedure – Power-On to Standby Mode

To turn the instrument on:

1. Connect the other end of the power cord to the rear panel **IEC C14 Chassis AC Power Socket** located in the right corner of the rear panel (#1). See [Figure 3-1](#)
2. Connect the supplied AC power cord to local AC mains power.

Procedure – Standby Mode to Operate Mode

To set the instrument to operate mode, press the power switch on the front panel.

- When fully in operate mode, with an attached monitor, the ShockLine MS46322A/B Series VNA displays the main trace display with the application menus on the right side. See [Figure 4-1, “User Interface - Four Traces - FREQUENCY Menu \(simulated data\)”](#) for a typical full screen display.

Note

When placing the ShockLine MS46322A/B Series VNA in operation, allow at least 45 minutes of warm-up time in the operate mode before using the VNA to assure stable operation and the highest possible accuracy.



Figure 3-2. ShockLine Series VNA Startup Splash Screen

Procedure – Power-Off

To turn the instrument off:

1. Turn off the instrument by pressing the front panel **AC Power** switch. **Do not** shut the instrument down from the Windows Start menu.
2. If necessary, the instrument can now be disconnected from the AC power mains.

Note	After turning off the instrument, you must wait at least 15 seconds before turning the instrument back on again. This delay is required to allow the internal power supplies to discharge and to assure a reliable cold start.
-------------	--

3-5 Connecting External Devices

After unpacking, the ShockLine MS46322A/B Series VNA ready for use although it is strongly recommended that you connect a monitor, keyboard and mouse to facilitate use of the ShockLine VNA application and operating system. The VNA supports the connection of most Windows-based peripherals.



- | | |
|--|---|
| 1. Rear Panel USB 2.0 Type A Ports (4) | 3. Ethernet RJ-45 (f) Ports (2) |
| 2. Rear Panel HDMI video port (1) | 4. Front Panel USB 2.0 Type A Ports (2) |

Figure 3-3. Front and Rear Panel USB 2.0 Connections

Connecting an External HDMI Monitor

The MS46322A/B VNA provides a standard HDMI video port on the rear panel. When connecting an external monitor, ensure that the instrument is in standby mode and that the monitor is disconnected from its power source. Once the monitor is connected, turn on its power and then set the VNA to **Operate**. The monitor should be automatically detected by the operating system and operational.

Connecting an External Mouse or Keyboard

The MS46322A/B VNA provides USB Type A connector ports on the front and rear panels that can be used for USB keyboard and mouse connections.

When connecting either a keyboard and/or mouse, ensure that the instrument is set to standby mode before connecting them. When the ShockLine MS46322A/B Series VNA is set to **Operate**, the keyboard and mouse should be automatically detected by the operating system and be ready for use. To use any advanced features of your external keyboard and mouse, follow the manufacturers installation instructions.

Note

Advanced keyboard and mouse features may not be supported in the analyzer application, but should function as expected in the Windows environment.

Connecting an External Printer

The external printer interface is typically connected through an available front or rear panel **USB Type-A Port**. Many printers will be recognized by the Windows operating system and require no further installation.

If installation and configuration is required, install your printer driver according to the manufacturer's directions. The hardware connection should be made when the VNA is in **Standby** or **Off** mode to allow for proper initialization of the hardware during boot-up of the operating system.

If you attempt to print from the VNA application before a printer is installed, a dialog box appears prompting you to install a printer.

Connecting Other USB Peripherals

Use any available USB 2.0 Type A Port for connecting other USB devices such as a scanner, external drive, camera, or USB flash drive. With the proper software drivers, a USB monitor can also be used with the ShockLine MS46322A/B Series VNA. For certain USB monitors, a black screen or splash screen may require the user to hold the Windows button and then press the "p" button twice to enable the display switch. The USB interface offers the same behavior that is typically experienced in the Windows operating system environment. If connection of multiple USB devices is considered, the use of a user-supplied powered USB hub is recommended.

3-6 Ethernet LAN TCP/IP Setup

The ShockLine MS46322A/B Series VNA supports Gigabit Ethernet. The ShockLine MS46322A/B Series VNA provides one **Ethernet RJ45 (f) connector** for a network connection.

The instrument is connected directly to the LAN via the rear panel RJ-45 Ethernet Port using a standard CAT-5 Ethernet cable.

Plug-and-Play Configuration

The ShockLine™ MS46322A/B Series VNA and its Windows operating system come pre-configured and ready to plug into and connect with an existing Ethernet network providing DNS/DHCP and configured with a gateway.

Connect to a LAN (Local Area Network) via the rear panel **Ethernet RJ45 (f) connector** using a standard CAT-5 Ethernet cable. The Windows operating system will automatically detect the network settings and configure the network connection.

Manually Configuring TCP/IP Ethernet LAN Settings

Note	This section is provided for general information about manually configuring an Ethernet connection. Consult your local network administrator for the exact requirements and settings that are required for your network installation.
-------------	---

To see the current network settings for your ShockLine MS46322A/B Series VNA, with the ShockLine Application Software running, navigate to the NETWORK INTERFACE menu as follows (see [Figure 3-4](#)):

- MAIN | System | SYSTEM | Network Interface | NETWORK INTERFACE

The detailed description of the menu, its operation, and connected dialog boxes are described in the **User Interface Reference Manual**.

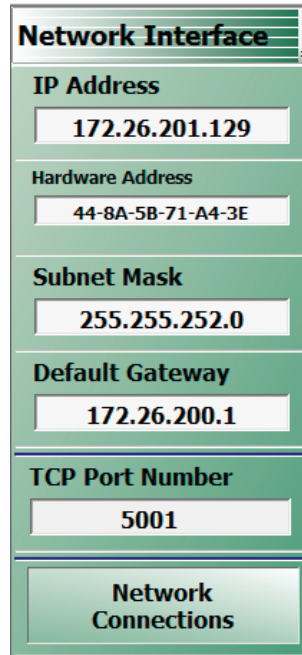

Figure 3-4. NETWORK INTERFACE Menu

The top five (5) display buttons provide information for the current network settings. Changes to these settings are made using Microsoft® Windows 10 IoT configuration utilities accessed by clicking the Network Connections button.

The NETWORK CONNECTIONS dialog box shows the current available local networks,

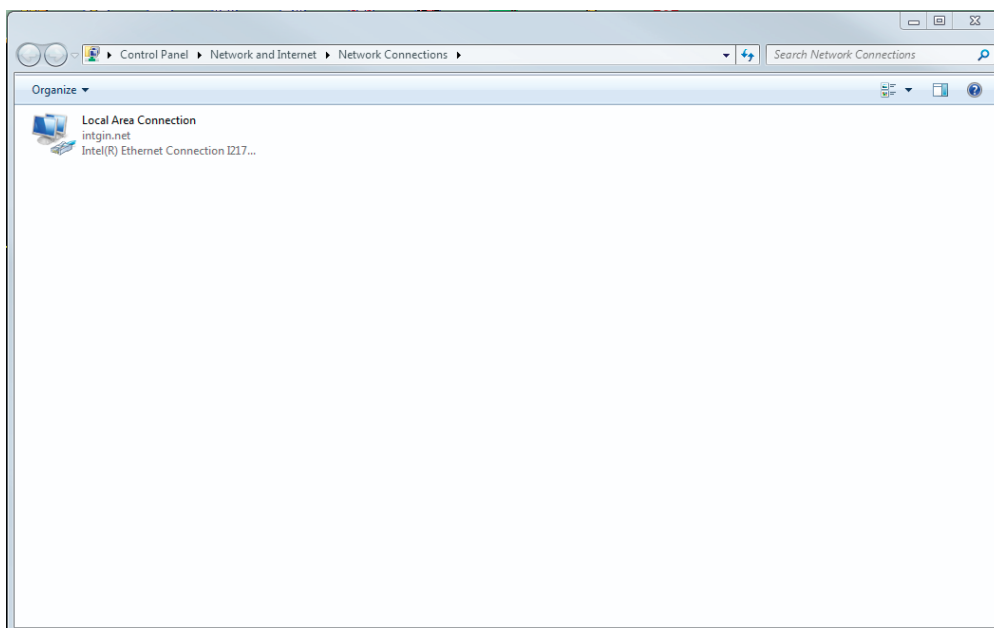

Figure 3-5. NETWORK CONNECTIONS Dialog Box

It provides access to various network configuration utilities and setup wizards as follows:

- A link to the Create a new connection wizard.
- A link to the Network Troubleshooter wizard.
- If connected to one or more networks, a link to each network name is provided with links to the settings of each connection.

Note

You may need to consult your network documentation or network administrator for assistance in manually configuring your network setup. The **Network Connections Help** system provides information related to computer networking. If an Internet connection is present, links to Microsoft and other URLs are also provided.

3-7 Starting the GUI Application

There are two ways that the MS46322A/B can be controlled:

1. Locally through the Graphical User Interface (GUI)
2. Remotely, via SCPI or IVI-C.

Locally

1. Connect the user-provided external monitor to the HDMI port of the MS46322A/B, refer to [Figure 3-3 on page 3-5](#).
2. Connect the user provided USB mouse and keyboard to the VNA.

Note

A touchscreen monitor may be used to control the VNA in lieu of the keyboard/mouse/monitor combination.

3. Power up the MS46322A/B.
 - Once powered up, you should see a GUI interface screen as [Figure 4-1 on page 4-1](#).

Remotely

1. Connect the user-provided external monitor to the HDMI port of the MS46322A/B if viewing the trace displays is desired. Refer to [Figure 3-3 on page 3-5](#).
2. Connect the RJ-45 connector to the rear panel RJ-45 port, refer to [Figure 3-3 on page 3-5](#).
3. Power up the MS46322A/B
 - You should see a GUI interface screen as [Figure 4-1 on page 4-1](#) if a monitor is in use.
4. Use SCPI, TCP/IP protocol with SOCKETS. For more information on setting up the SCPI, TCP/IP protocol with SOCKETS, refer to [Section 3-6 “Ethernet LAN TCP/IP Setup” on page 3-6](#). The user will have to download a development tool to setup the socket and there are many open source development tools for this purpose. Sockets will run SCPI with or without NI VISA.
5. Download the IVI-C driver from the ShockLine website:
<https://www.anritsu.com/en-US/test-measurement/support/downloads?model=MS46322B>

3-8 Updating ShockLine Software

Anritsu periodically updates the software used to control the MS46322A/B VNAs. Users are encouraged to keep their ShockLine VNA up-to-date with the latest ShockLine software by downloading and installing the latest software package from the Anritsu website.

Software Installation Procedure

1. Download and install the latest ShockLine VNA software onto the VNA from the Anritsu Website:
<https://www.anritsu.com/en-US/test-measurement/support/downloads?model=MS46322B>
2. If the download is successful, a ShockLine installer icon will appear on your VNA screen.
3. Run the ShockLine software installer as Administrator and follow the instructions displayed on the monitor to complete the installation of the software into the VNA.
4. Double click the ShockLine desktop icon to launch the ShockLine software to use the MS46322A/B with the graphical user interface.

3-9 Simulation Mode

Simulation Mode provides the same ShockLine VNA GUI as when hardware is detected, but is run from a user provided external pc without connecting to a VNA or external hardware, Simulation Mode provides the user testing scenarios with the benefits of real testing, except there are no real measurements resulting from a hardware test setup.

Benefits of Simulation Mode include:

- Import .SnP files to manipulate waveforms to be differential or time domain.
- Rework programming scenarios to check commands or setups
- Gain familiarity with the ShockLine GUI menus.

The following simple step-by-step procedure will setup the ShockLine VNA software in Simulation Mode.

Download onto your user provided external pc and launch the ShockLine Program available from the Anritsu ShockLine VNA Software library located at:

<https://www.anritsu.com/en-US/test-measurement/support/downloads?model=MS46322B>

1. Download the ShockLine VNA Software and launch the software.

- Once the ShockLine Software is loaded onto your PC, the initial startup screen will appear as shown in [Figure 3-6](#).



Figure 3-6. ShockLine GUI Initialization Screen

- From the No Hardware Found dialog box, [Figure 3-7](#), select yes to run in Simulation Mode.
 - No hardware will be detected if running the software on an independent computer for simulation.

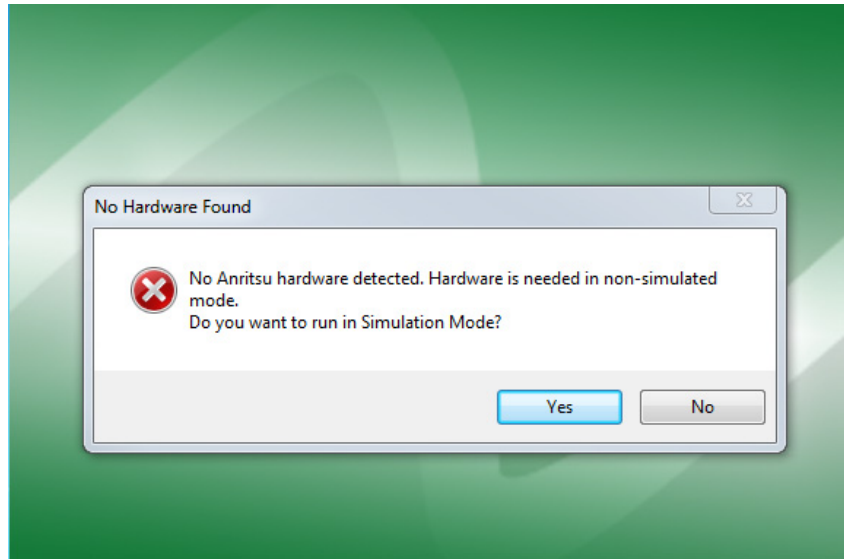

Figure 3-7. ShockLine GUI Initialization Screen

- Once Simulation Mode is selected, the default menu screen appears. See [Figure 3-8](#).
- Select the menu/option configuration that you wish to simulate.

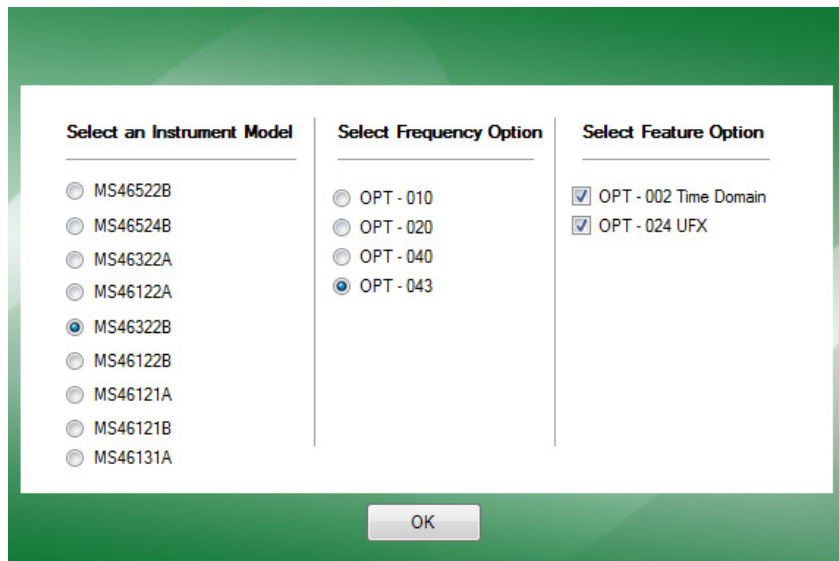

Figure 3-8. Simulator Select Instrument

- Once the ShockLine VNA model/configuration has been selected, press OK. The menus within the simulated program will provide the appropriate menu screens for the selected model/option configurations selected.

To learn more about the User Interface, see [Chapter 4, “User Interface Display”](#).

3-10 Calibration/Verification Interval

If the ShockLine MS46322A/B Series VNA requires service or calibration, the system may be returned to factory specifications and re-imaged with a standard software configuration. User installed applications and data may be lost and unable to be retrieved. It is advised that user data be backed up, copied, and retained by the user. Applications will need to be reinstalled from their original installation disks. A complete system restore from a previous user backup is not advised after service or calibration as this will result in the new calibrations being overwritten, thus voiding the calibration accuracy.

Chapter 4 — User Interface Display

4-1 Chapter Overview

The chapter provides orientation to the ShockLine application user interface for the ShockLine MS46322A/B Series VNAs. It also provides general descriptions and procedures for trace graph setup, marker setup, and limit line setup.

4-2 User Interface Main Screen

The main screen is shown below in [Figure 4-1](#). The key areas of the main screen are the Menu Bar, Icon Toolbar, and MAIN MENU right-side function menus. These are identified in [Figure 4-2 on page 4-2](#).

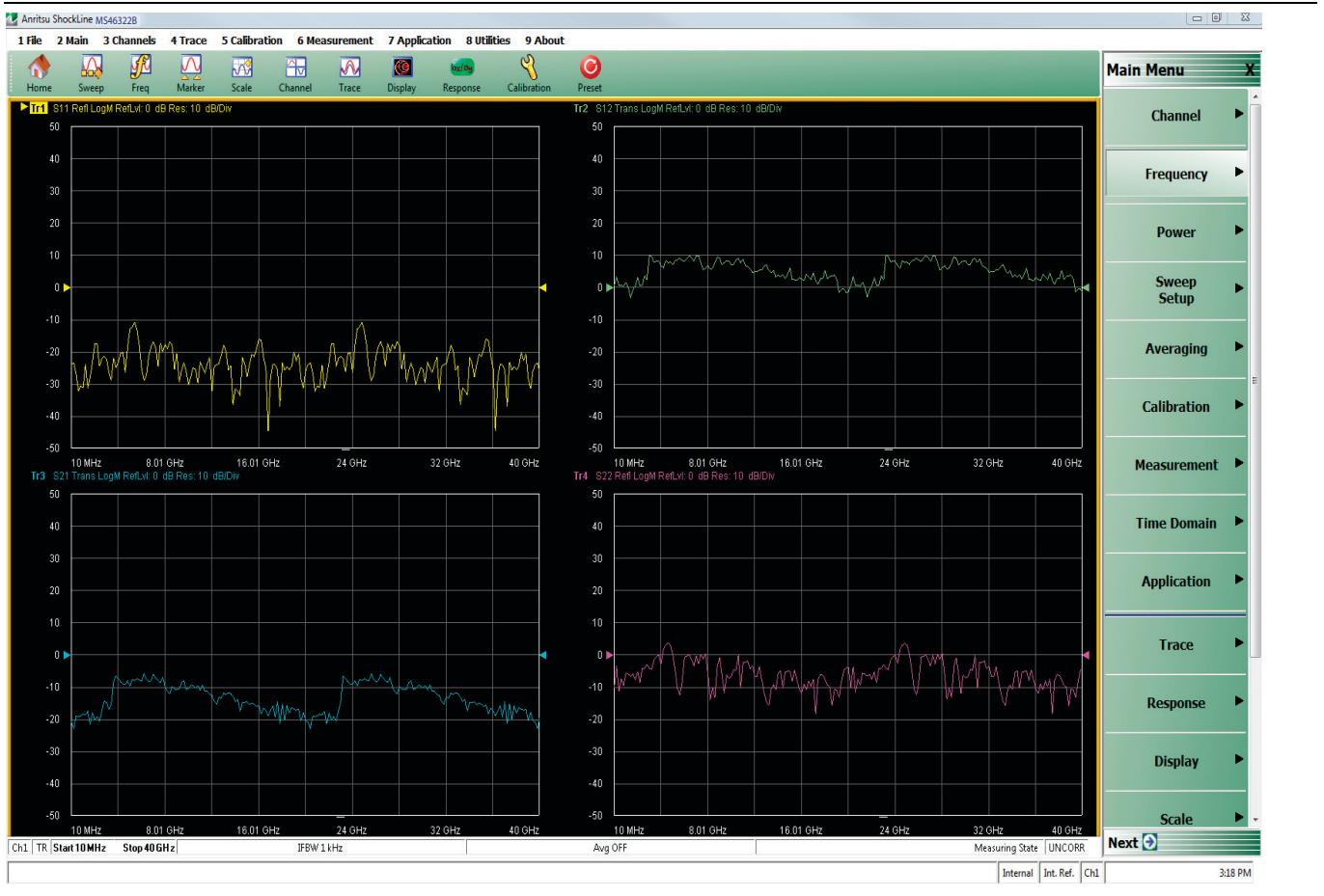
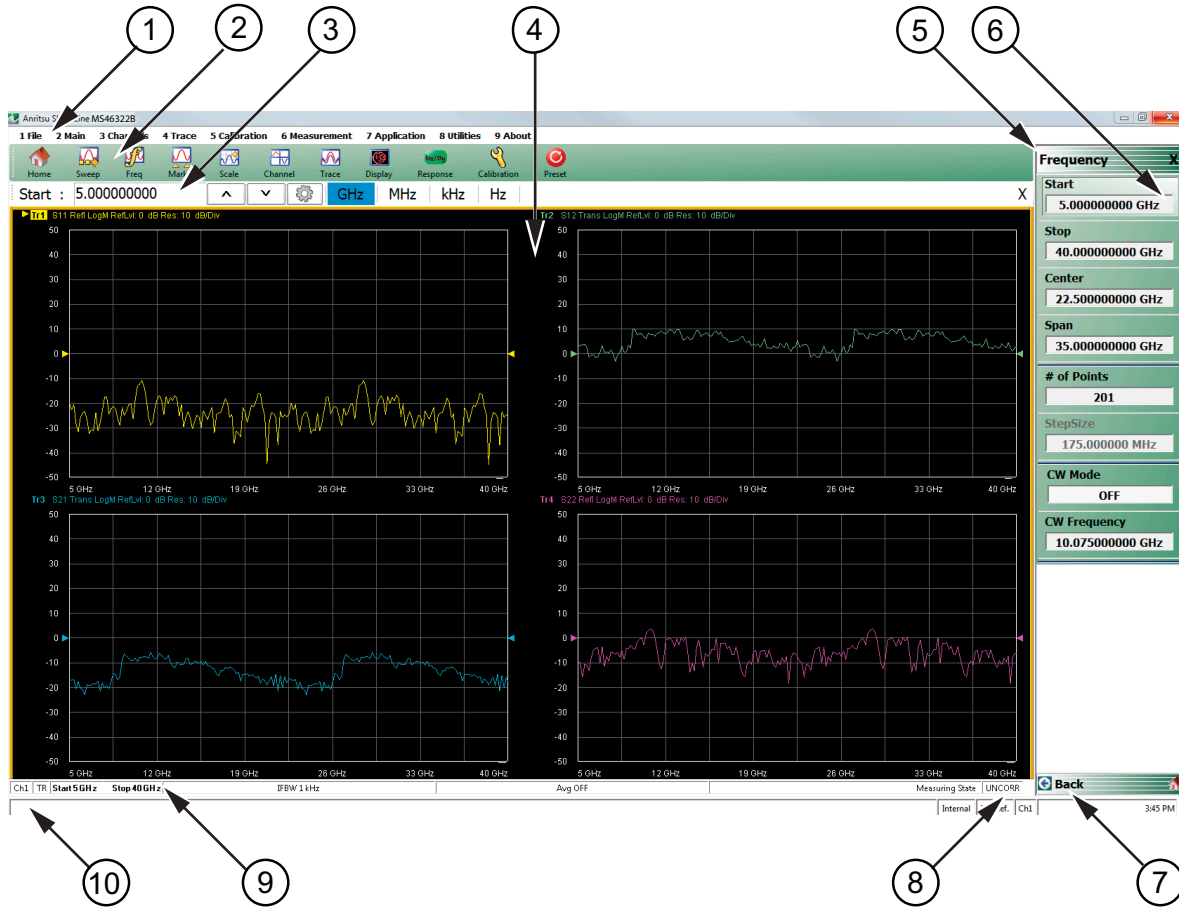

Figure 4-1. User Interface - Four Traces - FREQUENCY Menu (simulated data)

User Interface Control and Display Areas

Mouse clicks are the main way to control the instrument main display, though the keyboard can also be used for some items. **Figure 4-2** illustrates the general display areas and shows a single channel set up with four graphical traces.



1. Menu Bar – Displays nine (9) drop down menus: FILE, MAIN, CHANNELS, TRACE, CALIBRATION, MEASUREMENT, APPLICATION, UTILITIES, and ABOUT.
2. Icon Toolbar – User-configured with up to 20 user-selected quick access icons.
3. Field Toolbar – Appears only when field button is clicked for input. Display field for value, with one or more units (such as dB, dBm, or Hz), an Enter button, and an X close button.
4. Display Area – Displays from 1 to 16 trace display graphs. Each trace display can optionally have from 1 to 12 markers, a reference marker, and an upper and lower limit line.
5. Menu Title – Displays the name of the displayed right-side menu. Menu titles are unique to each menu.
6. Menu Buttons – The menu buttons allow the user to set parameters, make configuration selections, read result values, start processes, toggle between two or more values, display sub-menus, and display dialog boxes.
7. Menu Navigation Buttons – The navigation buttons always appear at the bottom of the right-side menu and allow browser-like forward and backward navigation through the user’s history. Back returns to previous selected higher-level menu, Next returns to a previously selected lower-level menu, and Home returns to the MAIN MENU.
8. System Status Bar – Displays status messages, and configuration status that affects the entire instrument.
9. Trace Status Bar – Provides status for active trace near the bottom of the screen.

Figure 4-2. User Interface Display Areas (1 of 2)

10. Tableau Data Display/Input Area – The tableau area only appears when the appropriate menu button is selected. When selected, the display shrinks upwards and the tabular data area expands.

Figure 4-2. User Interface Display Areas (2 of 2)

All ShockLine VNA models support up to 16 graphical traces. The figure below shows an instrument setup with four displayed windows, each with three (color coded) traces. The displayed trace display layout shown below is user-defined as a 2 × 2 configuration trace display.

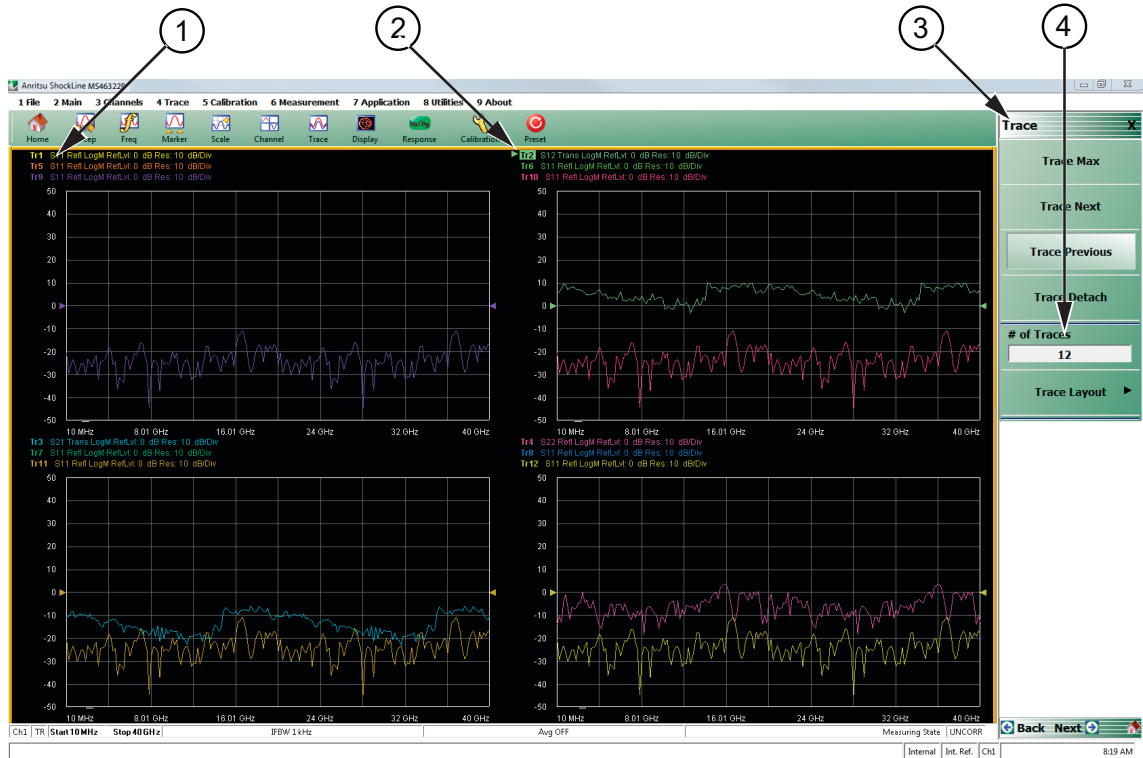

Figure 4-3. User Interface - 12 Traces (simulated data)

- | | |
|--|-------------------------------------|
| 1. Three Traces per screen in this example | 3. TRACE Menu |
| 2. Arrow Pointing to Active Trace | 4. # of Traces Selected For Viewing |

Function Access

The ShockLine MS46322A/B Series VNA provides access to the menus and functions through a USB-attached mouse and USB keyboard. These are used to manipulate the instrument through the five major user interface areas on the main display:

- The top Menu bar with its drop-down menus and menu commands.
- The Icon toolbar with up to 10 single-click functions, available as a default configuration or as a user-definable configuration of icon functions.
- The right side MAIN MENU provides access to function menus, sub-menus, dialog boxes, and configuration options.
- For some parameters, selecting a button displays a Field toolbar that appears just below the Icon toolbar allowing input of parameter values and units.
- For some parameters, selecting a button displays a Configuration or Setup tableau below the main display area for input of complex parameter sets such as segmented frequency or power sweeps.

Instrument setup begins at the CHANNEL menu, where the user can choose how many channels to use and designate their screen layout. Next, select a channel for operation and configure it. The following explains how to do basic channel setup. Once that is done, you can select sweep type and other parameters for each channel.

To Select a Channel

1. Select a channel in a multi-channel display by doing one of the following:
 - Click anywhere inside the desired channel box.
 - From the keyboard, enter **ALT + 3**, then **3** to view the previous channel or **ALT + 3**, then **4** to view the next channel.
 - On the top menu bar, select MENU BAR | Channels | Channel Prev or MENU BAR | Channel | Channel Next.
 - On the right side menu, select MAIN | Channels | CHANNELS | Chan Next or Chan Previous.
2. The selected channel border changes from gray to white. (Figure 4-3, “User Interface - 12 Traces (simulated data)” on page 4-3 shows Channel 2 (Ch2) selected.)

Note	The Ch->Max , Ch->Next , and Ch-Prev icons are available for the icon toolbar. These icons provide one click access to channel maximum, channel next, and channel previous functions. They can be added to the icon toolbar for a custom configuration and saved as part of a preset configuration.
-------------	--

To Maximize a Channel Display

1. Use one of the methods above to select the desired channel.
2. Do one of the following to maximize the selected channel:
 - From the keyboard, enter **CTRL + 1** or **ALT + 3**, then **2**.
 - On the main display, double-click the channel border box.
 - On the top menu bar, select Menu Bar | Channel | Channel Max.
 - On the right side menu, select MAIN | Channel | CHANNEL | Chan. Max.
3. The selected channel now fills the display area.
 - Maximize a channel display to review the channel status information at the bottom of its screen.

To Make the Display Area Larger

1. The top Icon toolbar can be hidden to make the display area larger.
2. Hide the Icon toolbar by doing one of the following:
 - From the keyboard, select **ALT + 6** then **2**.
 - On the top Menu bar, select Utilities | Toolbar Off.
3. The Icon toolbar disappears. Repeat **Step #2** to make the Icon toolbar re-appear.

To Select Traces

1. To select a trace in a multi-trace display, do one of the following:
 - With a mouse, single click the trace title.
 - If you double-click either the trace title or anywhere within the trace, the trace is both selected and maximized.
 - From the keyboard, enter **ALT + 2** then **7** to view the previous trace or **ALT + 3** then **8** to view the next trace.
 - On the top menu bar, select Menu Bar | Trace | Trace Prev or Menu Bar | Trace | Trace Next.
 - On the right side menu, select MAIN | Trace | TRACE | Trace Previous or Trace Next.

- The selected trace number is highlighted and a left arrow appears.



Figure 4-4. Trace Selection Indicator

Note

The **Tr->Max**, **Tr->Next**, and **Tr->Previous** icons are available for the icon toolbar. These icons provide one click access to trace maximum, trace next, and trace previous functions. They can be added to the icon toolbar for a custom configuration and saved as part of a preset configuration.

To Maximize a Trace Display

1. Use one of the methods above to select the desired trace.
2. For a maximum display, make sure the trace's channel is maximized.
3. Do one of the following to maximize the selected trace:
 - From the keyboard, select **ALT + 2**, then **6**.
 - On the main display, double-click anywhere in the trace display.
 - On the top menu bar, select Menu Bar | Trace | Trace Max.
 - On the right side menu, select MAIN | Trace | TRACE | Trace Max.
4. The selected trace now fills the display area.
 - Maximize a trace display to review the trace status information at the bottom of trace screen.
5. Repeat the actions above to return the trace to its normal size.

4-3 Using the Menu Bar Interface

Menu Bar Overview

The menu bar at the top of the screen provides drop-down menus for access to major ShockLine™ VNA functions and dialogs. The figure below shows all of the available Menu bar functions and command menus.

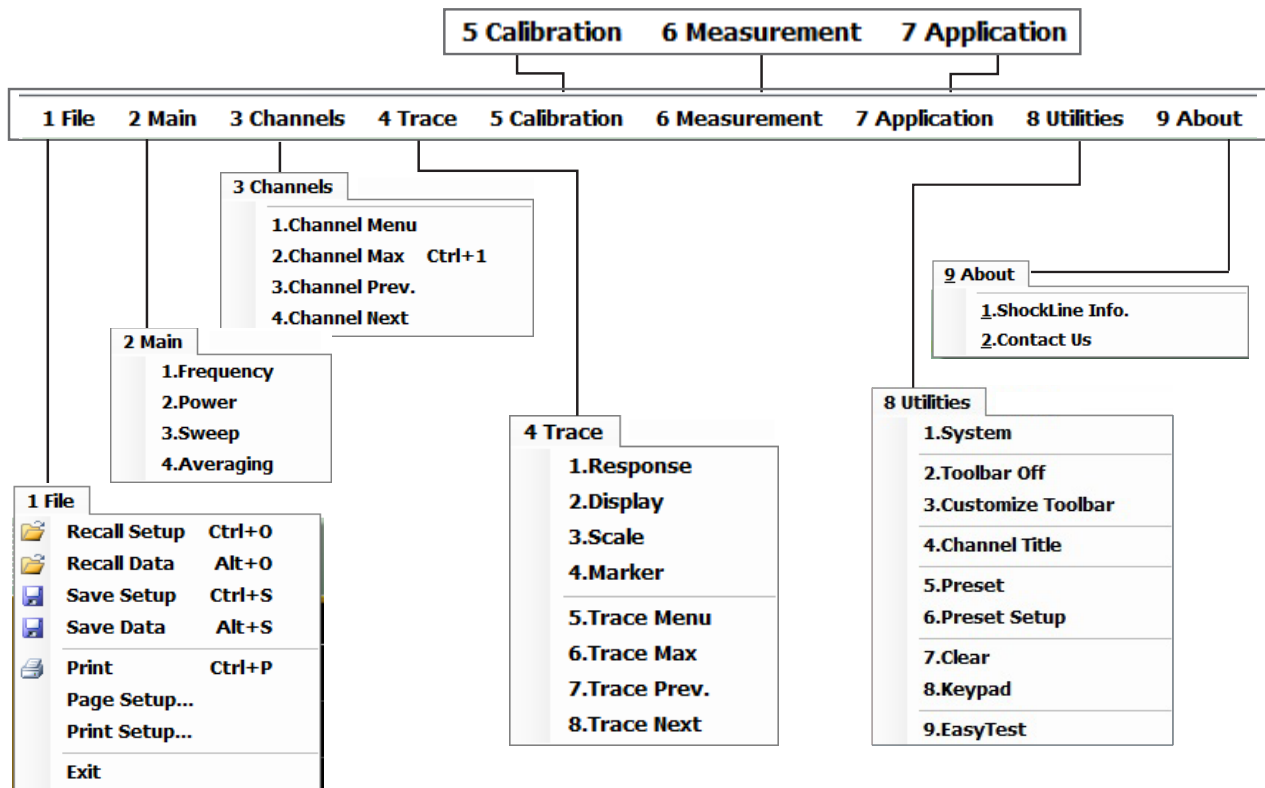

Figure 4-5. Menu Bar Major Functions, Drop-Down Menus, and Commands

Menu Bar General Operation

The Menu bar drop-down menus and commands can be accessed by clicking on the menu bar and required command.

The keyboard can be used to enter the menu and/or command short cut, most of which use the **ALT (ALTERNATE)** key. To access a menu from the keyboard, press and hold the **ALT (ALTERNATE)** key and the number in front of the menu name.

- For example, **ALT+1** opens the FILE menu.
- For example, **ALT+6** opens the UTILITY menu.

To access most commands listed on the drop-down menus, follow the **ALT +** sequence with the menu command number.

- For example, to access the Preset command on the UTILITIES menu, enter **ALT+6**, then **5**.
- For example, to access the right side SYSTEM menu, enter **ALT+6**, then **1**.

Some Menu Bar commands can also be accessed by using the keyboard **Control (CTRL)** key. Press and hold the **CTRL** key and then the letter key.

- For example, to recall a previously saved setup, enter **CTRL + O** (letter O).
- For example, to print the current display screen, enter **CTRL + P**.

Menu Bar Drop-down Menus and Commands

The menu bar appears at the top of the instrument display and provides direct access to system menus and some button functions.

The table below summarizes all menu bar drop-down commands. The **MS46121A/B, MS46122A/B, MS46131A, MS46322A/B User Interface Reference Manual** describes the resultant menus or commands in greater detail.

Table 4-1. Menu Bar Drop-Down Menu Descriptions (1 of 8)

Menu and Command Name	Menu and Command Descriptions
<p>FILE Menu</p> 	<ul style="list-style-type: none"> • Keyboard: ALT + 1 • Menu Bar File • MAIN File FILE <p>Recall Setup Command</p> <p>Select displays the RECALL SETUP dialog box and allows the recall of previously saved setup and/or calibration files:</p> <ul style="list-style-type: none"> – Active Channel Setup and Calibration (.chx) File – Active Channel Setup (.stx) File – All Channel Setup (.sta) File <ul style="list-style-type: none"> • Keyboard: CTRL + O (letter O) • Menu Bar File Recall Setup • MAIN File FILE Recall Setup RECALL SETUP Dialog Box <p>Recall Data Command</p> <p>Select displays the RECALL DATA dialog box and allows the recall of a previously saved active channel and/or active trace data file of these types:</p> <ul style="list-style-type: none"> – Active Channel S1P (*.s1p) File – Active Channel S2P (*.s2p) File – Formatted Data into Active Trace (*.tdf) File – Unformatted Data into Active Trace (*.tdu) File – Formatted Data into Active Trace Memory (*.tdf) File – Unformatted Data into Active Trace Memory (*.tdu) File <ul style="list-style-type: none"> • Keyboard: Keyboard: ALT + O (letter O) • Menu Bar File Recall Data • MAIN File FILE Recall Data RECALL DATA Dialog Box <p>Save Setup Command</p> <p>Select displays the Save Setup dialog box and allows the user to save the currently applied system presets configuration file.</p> <ul style="list-style-type: none"> • Keyboard: CTRL + S • Menu Bar File Save Setup • MAIN File FILE Save Setup SAVE SETUP Dialog Box

Table 4-1. Menu Bar Drop-Down Menu Descriptions (2 of 8)

Menu and Command Name	Menu and Command Descriptions						
	<p>Save Data Command Select displays the SAVE DATA (Active Channel.txt) dialog box. Use this dialog to save the current channel data file.</p> <ul style="list-style-type: none"> • Keyboard: ALT + S • Menu Bar File Save Data • MAIN File FILE Save Data SAVE DATA Dialog Box <p>Print Command Select displays the Windows PRINT dialog box to print the current main display.</p> <ul style="list-style-type: none"> • Keyboard: CTRL + P • Menu Bar File Print • MAIN File Print PRINT Dialog Box <p>Exit Command Select displays a confirmation dialog box. Click OK to exit the ShockLine application and return to the Windows desktop. Click Cancel to remain in the ShockLine application.</p> <ul style="list-style-type: none"> • Menu Bar File Exit 						
<p>TRACE Menu</p> 	<ul style="list-style-type: none"> • Keyboard: ALT + 4 • Menu Bar Trace • MAIN Trace TRACE <p>Response Command Select displays the right-side RESPONSE menu.</p> <ul style="list-style-type: none"> • Keyboard: ALT + 4 then 1 • Menu Bar Trace Response • MAIN Response RESPONSE <p>Display Command Select displays the right-side DISPLAY menu.</p> <ul style="list-style-type: none"> • Keyboard: ALT + 4, then 2 • Menu Bar Trace Display • MAIN Display DISPLAY <p>Scale Command Select displays the right-side SCALE menu. The SCALE menu reference heading and button options depend on the display type selected with TRACE FORMAT selection:</p> <table border="0" data-bbox="469 1709 1289 1772"> <tr> <td>- Log Mag</td> <td>- Phase</td> <td>- Imaginary</td> </tr> <tr> <td>- Linear Mag</td> <td>- Real</td> <td>- VSWR</td> </tr> </table> <ul style="list-style-type: none"> • Keyboard: ALT + 4, then 3 • Menu Bar Trace Scale • MAIN Scale SCALE 	- Log Mag	- Phase	- Imaginary	- Linear Mag	- Real	- VSWR
- Log Mag	- Phase	- Imaginary					
- Linear Mag	- Real	- VSWR					

Table 4-1. Menu Bar Drop-Down Menu Descriptions (3 of 8)

Menu and Command Name	Menu and Command Descriptions
	<p>Marker Command Select displays the right-side MARKERS [1] menu.</p> <ul style="list-style-type: none"> • Keyboard: ALT + 4, then 4 • Menu Bar Trace Marker • MAIN Marker MARKER [1] <p>Trace Menu Command Select displays the right-side TRACE menu.</p> <ul style="list-style-type: none"> • Keyboard: ALT + 4, then 5 • Menu Bar Trace Trace Menu • MAIN Trace TRACE <p>Trace Max Command Select maximizes the active trace to full screen display. Selecting again, returns the trace to the standard multi-trace display.</p> <ul style="list-style-type: none"> • Keyboard: ALT + 4, then 6 • Menu Bar Trace Trace Max • MAIN Trace TRACE Trace Max <p>Trace Previous Command Selects the next lower trace number on the active channel. If Trace 1 is currently selected, the highest numbered trace is selected. If the current trace is not maximized, the previous trace will not be maximized. If the current trace is maximized, the previous trace will be maximized.</p> <ul style="list-style-type: none"> • Keyboard: ALT + 4, then 7 • Menu Bar Trace Trace Prev. • MAIN Trace TRACE Trace Previous <p>Trace Next Command Selects the next higher trace number on the active channel. If the highest numbered trace is currently displayed, the Trace 1 is displayed. If the current trace is not maximized, the next trace will not be maximized. If the current trace is maximized, the next trace will be maximized.</p> <ul style="list-style-type: none"> • Keyboard: ALT + 4, then 8 • Menu Bar Trace Trace Next • MAIN Trace TRACE Trace Previous

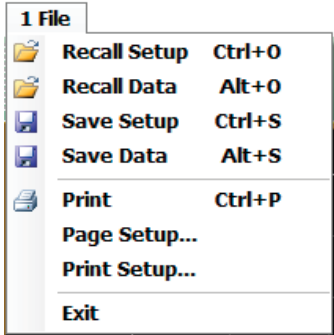
Table 4-1. Menu Bar Drop-Down Menu Descriptions (4 of 8)

Menu and Command Name	Menu and Command Descriptions
<p>CALIBRATION Menu</p> 	<p>The CALIBRATION menu command opens the right-side CALIBRATION menu.</p> <ul style="list-style-type: none"> • Keyboard: ALT + 5 • Menu Bar Calibration • MAIN Calibration CALIBRATION
<p>MEASUREMENT Menu</p> 	<p>The MEASUREMENT menu command opens the right-side MEASUREMENT menu.</p> <ul style="list-style-type: none"> • Keyboard: ALT + 6 • Menu Bar Measurement • MAIN Measurement MEASUREMENT
<p>APPLICATION Menu</p> 	<p>The APPLICATION menu command opens the right-side APPLICATION menu.</p> <ul style="list-style-type: none"> • Keyboard: ALT + 7 • Menu Bar Application • MAIN Application APPLICATION

Table 4-1. Menu Bar Drop-Down Menu Descriptions (5 of 8)

Menu and Command Name	Menu and Command Descriptions
<p>UTILITIES Menu</p> 	<ul style="list-style-type: none"> • Keyboard: ALT + 8 • Menu Bar Utilities <p>System Command Select displays the right-side SYSTEM menu.</p> <ul style="list-style-type: none"> • Keyboard: ALT + 8, then 1 • Menu Bar Utilities System • MAIN System SYSTEM <p>Toolbar Off Command Toggles the ICON TOOLBAR, immediately below the Menu Bar, on and off.</p> <ul style="list-style-type: none"> • Keyboard: ALT + 8, then 2 • Menu Bar Utilities Toolbar Off <p>Customize Toolbar Command Select displays the CUSTOMIZE TOOLBAR dialog box and allows the user to select which icons are to be displayed in the toolbar. Up to 20 icons can be displayed at one time. The Icon toolbar configuration is saved when a Preset Save is completed.</p> <ul style="list-style-type: none"> • Keyboard: ALT + 8, then 3 • Menu Bar Utilities Customize Toolbar <p>Channel Title Command Select displays the DISPLAY SETUP menu and allows a user-defined title to be applied to and displayed above the active channel. Each channel can have a different or the same title.</p> <ul style="list-style-type: none"> • Keyboard: ALT + 8, then 4 • Menu Bar Utilities Channel Title • MAIN Display DISPLAY Display Area Setup DISPLAY SETUP Edit Chan. Title EDIT CHANNEL TITLE Dialog Box <p>Preset Command</p> <ul style="list-style-type: none"> • Returns the instrument to its prior saved state which can be either the factory-default preset, or a user-defined setup. The PRESET SETUP menu selection defines which is used. • Keyboard: ALT + 8, then 5 • Menu Bar Utilities Preset • No right-side menu available to preset the instrument: <ul style="list-style-type: none"> – Use the Menu Bar Function above. • Navigation to the PRESET SETUP: MAIN System SYSTEM Setup SETUP Preset Setup PRESET SETUP

Table 4-1. Menu Bar Drop-Down Menu Descriptions (6 of 8)

Menu and Command Name	Menu and Command Descriptions
	<p>Clear Command</p> <p>Select toggles the displayed right-side menu off and on. When toggled back on, the previously selected menu is displayed. For example, if the CALIBRATE function menu was displayed when the display was cleared, the CALIBRATE function menu is again displayed when Clear is selected a second time.</p> <ul style="list-style-type: none"> • Keyboard: ALT + 8, then 7 • Menu Bar Utilities Clear Command <p>Keypad</p> <p>Select toggles the keypad on or off.</p> <ul style="list-style-type: none"> • Keyboard: ALT + 8, then 8 • Menu Bar Utilities Keypad <p>EasyTest</p> <p>Select brings up a file system browser for selection of an EasyTest script, and once one is chosen, ShockLine opens EasyTest with that script.</p> <ul style="list-style-type: none"> • Keyboard: ALT + 8, then 9 <p>Menu Bar Utilities EasyTest</p>

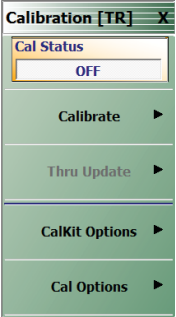
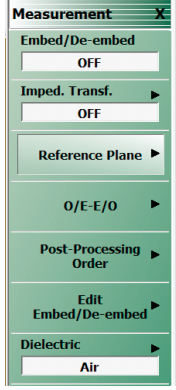
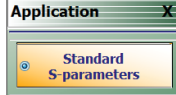
Table 4-1. Menu Bar Drop-Down Menu Descriptions (7 of 8)

Menu and Command Name	Menu and Command Descriptions
<p>ABOUT Menu</p> 	<ul style="list-style-type: none"> • Keyboard: ALT + 9 • Menu Bar About <p>ShockLine Info Command</p> <p>Select displays the SHOCKLINE INFO dialog box with typical information as shown below.</p>  <p>The dialog box provides instrument configuration information. Click OK to close the dialog box. The following information is provided:</p> <ul style="list-style-type: none"> – Copyright Statement – Software Version – DSP Version – Model # (Model Number) – SerNum# (Serial Number) – Options Installed <p>Keypad</p> <ul style="list-style-type: none"> • Keyboard: ALT + 9, then 1 • Menu Bar About ShockLine Info

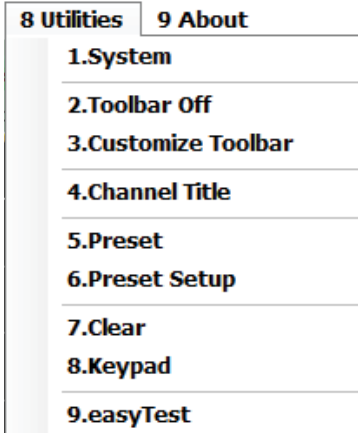
Table 4-1. Menu Bar Drop-Down Menu Descriptions (8 of 8)

Menu and Command Name	Menu and Command Descriptions
	<p data-bbox="469 247 751 279">Contact Us Command</p> <p data-bbox="469 289 1406 348">Select displays the CONTACT US dialog box with typical information as shown below.</p> <div data-bbox="491 365 1410 928"><p data-bbox="533 443 884 474">Anritsu Shockline™ VNA</p><p data-bbox="533 531 1054 562">Have Questions? Please contact us at:</p><p data-bbox="533 573 906 604">+1-800-ANRITSU or +1-800-267-4878</p><p data-bbox="533 642 1003 674">For product updates, please go to:</p><p data-bbox="533 684 1062 716">www.anritsu.com/test-measurement/network-analyzer/</p><p data-bbox="1129 684 1214 716">Go Now</p><p data-bbox="533 785 1003 816">©2020 Anritsu Company. All rights reserved.</p><p data-bbox="922 842 959 873">OK</p></div>

4-4 Icon Toolbar

Overview

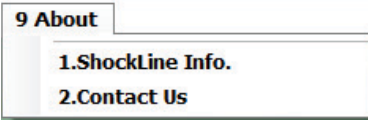
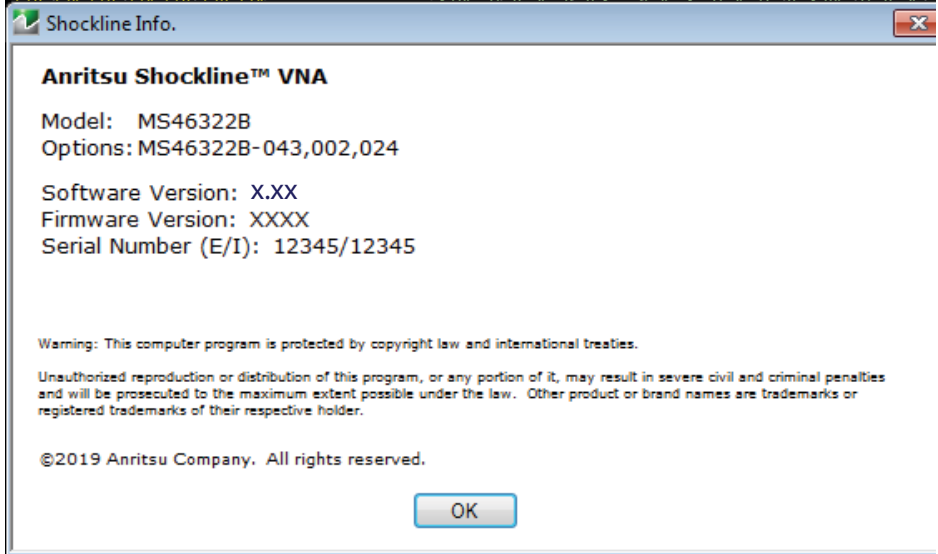
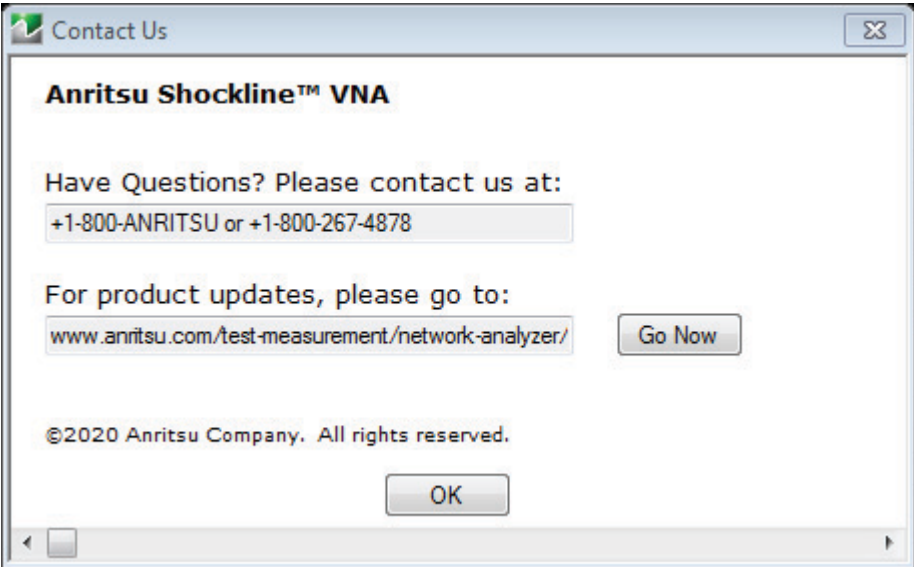
The Icon Toolbar is located immediately below the Menu Bar and allows single-click access to many menus and functions. The icon toolbar is user-configurable and up to 20 icons can be displayed in any configuration.

Using the Icon Toolbar Interface

The default Icon Toolbar is shown below:



The definitions and functions of the default icons are (from left to right):

- **Home Icon** – Select displays the right side MAIN MENU. Does not reset or lose previously set values.
- **Sweep Icon** – Select displays the right-side Sweep menu.
- **Freq Icon** – Select displays the right-side FREQUENCY menu.
- **Marker Icon** – Select displays the right-side MARKERS [1] menu.
- **Scale Icon** – Select displays the right-side SCALE menu.
- **Channel Icon** – Select displays the right-side CHANNEL menu.
- **Trace Icon** – Select displays the right-side TRACE menu.
- **Display Icon** – Select displays the right-side DISPLAY menu.
- **Response Icon** – Select displays the right-side RESPONSE menu.
- **Calibration Icon** – Select displays the right-side CALIBRATION menu.
- **Preset Icon** – Select returns the system to its prior preset status at the time of the last preset save. All available icons are described in the in [Table 4-2](#).

Figure 4-6. Icon Toolbar with Factory Default Function Icons

Available Icon Functions

The available icon functions that can be added to a user-defined icon toolbar are listed in [Table 4-2](#). Once configured, a preset save allows the toolbar configuration to be recalled at any time.

The procedures for changing the icon toolbar are described following the icon table and uses the “[CUSTOMIZE \(ICON\) TOOLBAR Dialog Box](#)” on [page 4-22](#). When a user-defined toolbar is configured, the first selected icon goes to the left-most position on the toolbar. Subsequent selected icons are added to the right-most position on the toolbar.

Table 4-2. Icon Descriptions - Listed Alphabetically (1 of 6)







Icon Name	Icon	Description
Icon Description Definitions		<p>Default Icons – These are one of the 11 default icons and are provided after a return to the factory standard configuration.</p> <p>Keyboard – If available, the keyboard shortcut to access this menu or function.</p> <p>Menu Bar – If available, navigation path to access this menu or function.</p> <p>Navigation – To navigate to this menu or function from the MAIN menu.</p> <p>Description – If available, where this menu, dialog box, or function is described in greater detail in this document.</p>
Application Icon	 Application	Select displays the right-side APPLICATION menu. <ul style="list-style-type: none"> • Front Panel Key: Application • Keyboard: ALT + 6 • Menu Bar: MENU BAR 6 Application 6 APPLICATION • MAIN Application APPLICATION
Average Icon	 Average	Default Icon. Select displays the right-side AVERAGING menu. <ul style="list-style-type: none"> • Front Panel Key: Avg (Average) • Keyboard: ALT + 2, then 4 • MENU BAR Channel Averaging • MAIN Averaging AVERAGING
Calibration Icon	 Calibration	Default Icon. Select displays the right-side CALIBRATION menu. <ul style="list-style-type: none"> • Keyboard: ALT + 5 • Menu Bar Calibration • MAIN Calibration CALIBRATION
Continue Icon	 Continue	After a system pause or hold with the Hold icon, the Continue icon resumes operation with all prior settings in effect. <ul style="list-style-type: none"> • MAIN Sweep Setup SWEEP SETUP Hold Functions HOLD FUNCTIONS Continue
Channel Icon	 Channel	Default Icon. Select displays the right-side CHANNEL menu <ul style="list-style-type: none"> • MAIN Channel
Ch->Max Icon	 Ch->Max	When multiple channels are used, select activates and displays the channel with the maximum trace value. <ul style="list-style-type: none"> • MAIN Channels CHANNELS Channel Max

Table 4-2. Icon Descriptions - Listed Alphabetically (2 of 6)







Icon Name	Icon	Description
Icon Description Definitions		<p>Default Icons – These are one of the 11 default icons and are provided after a return to the factory standard configuration.</p> <p>Keyboard – If available, the keyboard shortcut to access this menu or function.</p> <p>Menu Bar – If available, navigation path to access this menu or function.</p> <p>Navigation – To navigate to this menu or function from the MAIN menu.</p> <p>Description – If available, where this menu, dialog box, or function is described in greater detail in this document.</p>
Ch->Next Icon	 Ch->Next	<p>When multiple channels are used, select activates and displays the next higher channel number. If the highest channel number is currently active, channel 1 (one) is activated and displayed.</p> <ul style="list-style-type: none"> • MAIN Channels CHANNELS Channel Next
Ch->Prev Icon	 Ch->Prev	<p>When multiple channels are used, select activates and displays the next lower channel number. If channel 1 (one) is currently active, the highest numbered channel is activated and displayed.</p> <ul style="list-style-type: none"> • MAIN Channels CHANNELS Channel Prev.
Custom Icon 1		<p>Select performs the action defined for Custom Icon 1 using the right-side context menu. After definition, custom-action icons are displayed in the Icon Bar.</p> <p>The steps to define a Custom-action Icon are described in the <i>MS46121A/B, MS46122A/B, MS46131A, MS46322A/B User Interface and Reference Manual (10410-00337)</i>.</p>
Custom Icon 2		<p>Select performs the action defined for Custom Icon 2 using the right-side context menu. After definition, custom-action icons are displayed in the Icon Bar.</p> <p>The steps to define a Custom-action Icon are described in the <i>MS46121A/B, MS46122A/B, MS46131A, MS46322A/B User Interface and Reference Manual (10410-00337)</i>.</p>
Custom Icon 3		<p>Select performs the action defined for Custom Icon 3 using the right-side context menu. After definition, custom-action icons are displayed in the Icon Bar.</p> <p>The steps to define a Custom-action Icon are described in the <i>MS46121A/B, MS46122A/B, MS46131A, MS46322A/B User Interface and Reference Manual (10410-00337)</i>.</p>
Custom Icon 4		<p>Select performs the action defined for Custom Icon 4 using the right-side context menu. After definition, custom-action icons are displayed in the Icon Bar.</p> <p>The steps to define a Custom-action Icon are described in the <i>MS46121A/B, MS46122A/B, MS46131A, MS46322A/B User Interface and Reference Manual (10410-00337)</i>.</p>
Custom Icon 5		<p>Select performs the action defined for Custom Icon 5 using the right-side context menu. After definition, custom-action icons are displayed in the Icon Bar.</p> <p>The steps to define a Custom-action Icon are described in the <i>MS46121A/B, MS46122A/B, MS46131A, MS46322A/B User Interface and Reference Manual (10410-00337)</i>.</p>

Table 4-2. Icon Descriptions - Listed Alphabetically (3 of 6)









Icon Name	Icon	Description
Icon Description Definitions		<p>Default Icons – These are one of the 11 default icons and are provided after a return to the factory standard configuration.</p> <p>Keyboard – If available, the keyboard shortcut to access this menu or function.</p> <p>Menu Bar – If available, navigation path to access this menu or function.</p> <p>Navigation – To navigate to this menu or function from the MAIN menu.</p> <p>Description – If available, where this menu, dialog box, or function is described in greater detail in this document.</p>
Display Icon	 Display	<p>Default Icon. Select displays the right-side DISPLAY menu.</p> <ul style="list-style-type: none"> • Keyboard: ALT + 4, then 2 • Menu Bar Trace Display • MAIN Trace TRACE
EasyTest Icon	 Easy Test	<p>Select displays the Easy Test dialog box for loading EasyTest work instruction (ETT) files. These scripts can be generated with the separate <i>EasyTest Tools</i> PC application. The installer for this application is available for download from the Anritsu website.</p> <ul style="list-style-type: none"> • Keyboard: ALT + 8, then 9 • Menu Bar Utilities EasyTest
File Icon	 File	<p>Select displays the right-side FILE menu.</p> <ul style="list-style-type: none"> • Keyboard: ALT + 1 • MAIN File FILE
Freq Icon	 Freq	<p>Default Icon. Select displays the right-side FREQUENCY menu.</p> <ul style="list-style-type: none"> • MAIN Frequency FREQUENCY
Hold Icon	 Hold	<p>Default Icon. Select pauses the system operation, retaining all system presets and current configuration settings.</p> <ul style="list-style-type: none"> • MAIN Sweep Setup SWEEP SETUP Hold Functions HOLD FUNCTIONS Hold
Home Icon	 Home	<p>Select displays the right-side main menu. Does not reset or lose previous set values.</p> <ul style="list-style-type: none"> • MAIN
Marker->Max Icon	 Marker->Max	<p>Select displays marker with maximum value. Retains previous setting</p> <ul style="list-style-type: none"> • MAIN Marker MARKER [1] Marker Search MARKER SEARCH Max
Marker->Min Icon	 Marker->Min	<p>Select displays the marker with minimum value.</p> <ul style="list-style-type: none"> • MAIN Marker MARKER [1] Marker Search MARKER SEARCH Min

Table 4-2. Icon Descriptions - Listed Alphabetically (4 of 6)







Icon Name	Icon	Description
<i>Icon Description Definitions</i>		<p>Default Icons – These are one of the 11 default icons and are provided after a return to the factory standard configuration.</p> <p>Keyboard – If available, the keyboard shortcut to access this menu or function.</p> <p>Menu Bar – If available, navigation path to access this menu or function.</p> <p>Navigation – To navigate to this menu or function from the MAIN menu.</p> <p>Description – If available, where this menu, dialog box, or function is described in greater detail in this document.</p>
Marker->Off Icon	 Marker->Off	<p>Select turns all marker displays off.</p> <ul style="list-style-type: none"> MAIN Marker MARKER [1] Marker Setup MARKER SETUP All Markers Off
Marker->Peak Icon	 Marker->Peak	<p>Select displays marker with the highest peak value.</p> <ul style="list-style-type: none"> MAIN Marker MARKER [1] Marker Search MARKER SEARCH Peak PEAK Search Peak
Marker->Pk Lft Icon	 Marker->Pk Lft	<p>Select displays the next peak value marker to the left of current selected marker.</p> <ul style="list-style-type: none"> MAIN Marker MARKER [1] Marker Search MARKER SEARCH Peak PEAK Search Left
Marker->Pk Rt Icon	 Marker->Pk Rt	<p>Select moves the current active marker to the next trace peak value to the right of its current position.</p> <ul style="list-style-type: none"> MAIN Marker MARKER [1] Marker Search MARKER SEARCH Peak PEAK Search Right
Marker Icon	 Marker	<p>Default Icon. Select displays the right-side MARKERS [1] menu.</p> <ul style="list-style-type: none"> Keyboard: ALT + 4, then 4 Menu Bar Trace Marker MAIN Marker MARKER [1]
Measurement Icon	 Measurement	<p>Select displays the right-side MEASUREMENT menu.</p> <ul style="list-style-type: none"> Keyboard: ALT + 6 Menu Bar Measurement MEASUREMENT MAIN Measurement
Power Icon	 Power	<p>Default Icon. Select displays the right-side POWER menu.</p> <ul style="list-style-type: none"> MAIN Power POWER
Preset Icon	 Preset	<p>Default Icon. Select returns the system to its prior preset status which is the status at the time of the last preset save.</p> <ul style="list-style-type: none"> Keyboard: ALT + 8, then 5 Menu Bar Utilities Preset

Table 4-2. Icon Descriptions - Listed Alphabetically (5 of 6)











Icon Name	Icon	Description
Icon Description Definitions		<p>Default Icons – These are one of the 11 default icons and are provided after a return to the factory standard configuration.</p> <p>Keyboard – If available, the keyboard shortcut to access this menu or function.</p> <p>Menu Bar – If available, navigation path to access this menu or function.</p> <p>Navigation – To navigate to this menu or function from the MAIN menu.</p> <p>Description – If available, where this menu, dialog box, or function is described in greater detail in this document.</p>
Print Icon	 Print	<p>Select displays the PRINT dialog box, usually to print a copy of the main display. Once the dialog box appears, click OK to print; click Cancel to abort.</p> <ul style="list-style-type: none"> • Keyboard: ALT + 1, then P • Menu Bar File Print • MAIN File FILE Print PRINT Dialog Box
Response Icon	 Response	<p>Default Icon. Select displays the right-side RESPONSE menu.</p> <ul style="list-style-type: none"> • Keyboard: ALT + 4, then 1 • Menu Bar Trace Response • MAIN Response RESPONSE
Scale Icon	 Scale	<p>Default Icon. Select displays the right-side SCALE menu.</p> <ul style="list-style-type: none"> • Keyboard: ALT + 4, then 3 • Menu Bar Trace Scale • Main Scale SCALE
Sweep Icon	 Sweep	<p>Select displays the right-side SWEEP SETUP menu.</p> <ul style="list-style-type: none"> • MAIN Sweep Setup SWEEP SETUP
System Icon	 System	<p>Select displays the right-side SYSTEM menu.</p> <ul style="list-style-type: none"> • Keyboard: ALT + 8, then 1 • Menu Bar Utilities System • MAIN System SYSTEM
Time Domain Icon	 Time Domain	<p>Select opens Time Domain menu.</p> <ul style="list-style-type: none"> • MAIN Time Domain TIME DOMAIN
Trace Icon	 Trace	<p>Default Icon. Select displays the right-side TRACE menu.</p> <ul style="list-style-type: none"> • Keyboard: ALT + 4, then 5 • Menu Bar Trace Trace Menu • MAIN Trace TRACE
Tr->Max Icon	 Tr->Max	<p>Select maximizes the display with the currently active trace.</p> <ul style="list-style-type: none"> • Keyboard: ALT + 4, then 6 • Menu Bar Trace Trace Max • MAIN Trace TRACE Trace Max

Table 4-2. Icon Descriptions - Listed Alphabetically (6 of 6)

Icon Name	Icon	Description
<i>Icon Description Definitions</i>		<p>Default Icons – These are one of the 11 default icons and are provided after a return to the factory standard configuration.</p> <p>Keyboard – If available, the keyboard shortcut to access this menu or function.</p> <p>Menu Bar – If available, navigation path to access this menu or function.</p> <p>Navigation – To navigate to this menu or function from the MAIN menu.</p> <p>Description – If available, where this menu, dialog box, or function is described in greater detail in this document.</p>
Tr->Next Icon	 Tr->Next	Select displays the next higher trace number. When the highest trace number is reached, the next click displays trace number 1 (one). <ul style="list-style-type: none"> • Keyboard: ALT + 4, then 8 • Menu Bar Trace Trace Next • MAIN Trace TRACE Trace Next
Tr->Previous Icon	 Tr->Previous	Select displays the next lower trace number. When the lowest trace number 1 is reached, the next click displays the highest numbered trace. <ul style="list-style-type: none"> • Keyboard: ALT + 4 then 7 • Menu Bar Trace Trace Previous • MAIN Trace TRACE Trace Previous

CUSTOMIZE (ICON) TOOLBAR Dialog Box

Use the CUSTOMIZE TOOLBAR dialog box to setup the Icon toolbar with the icons you need for quick access to commands and functions. Once configured, and after a Preset Configuration save, the Icon toolbar settings can be recalled with the other preset configuration parameters.

Previous

- [“UTILITIES Menu” on page 4-11](#)

Keyboard

- **ALT + 7, then 3**

Navigation

- Menu Bar | Utilities | Customize Toolbar | CUSTOMIZE TOOLBAR Dialog Box

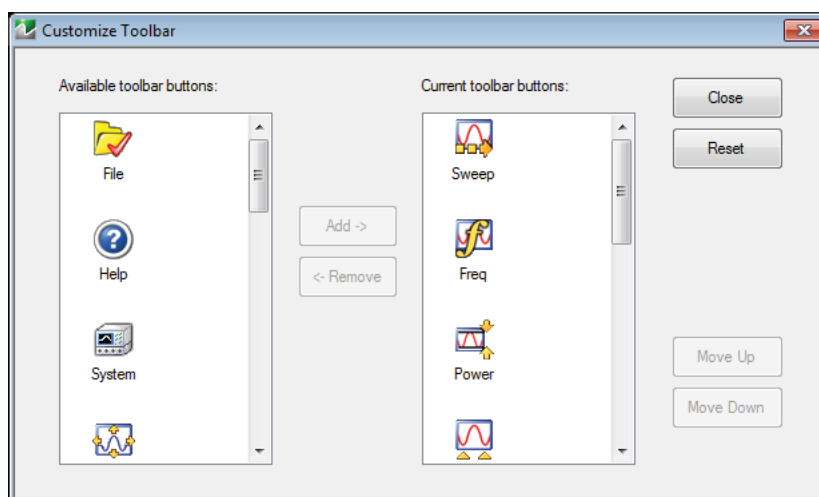

Figure 4-7. CUSTOMIZE TOOLBAR Dialog Box

Procedure

With the CUSTOMIZE TOOLBAR dialog box open, the left-side Available Toolbar Buttons area shows icons that are not in use on the current toolbar, while the right-side Current Toolbar Buttons area shows the current in-use icons.

Removing Icons

1. To change the icons in the current icon toolbar, in the right side Current Toolbar Button area, select an icon to remove. When selected, the Add-> and <-Remove buttons become available.
2. Remove unwanted icons as required by selecting the icon and then clicking the <-Remove button.
3. Removed icons appear at the bottom of the Available Toolbar Buttons list.

Adding Icons

1. Scroll through the Available Toolbar Buttons list and select an icon to add, then click the Add-> button. The selected icon appears in the right side Current Toolbar Buttons area.
2. Repeat the selection process until all required icons listed in the right side Current Toolbar Buttons area or you have reached the maximum of 20 icons.
3. In the Current Toolbar Buttons display, the icon displayed at the top of the list will appear on the extreme left of the toolbar. The last icon displayed at the bottom of the list will appear on the extreme right of the toolbar.

Moving Icons

To change the left to right sequence of the current icons, select an icon, and click the Move Up/Move Down buttons until the icons are correctly positioned left to right.

Saving the Configuration

When the icons are in the correct sequence. Click the Close button to apply the icons to the icon toolbar. It is recommended that a Preset Save be performed to save the icon toolbar configuration. If the icon toolbar needs adjustment, re-open the Customize Toolbar dialog box and repeat the steps above.

Reset to Factory Default

To return the icon toolbar to its factory default state, click the Reset button.

4-5 MAIN Menu and Application Menus

This section summarizes the MAIN MENU, which is the home menu for all right-side menu interface menus, dialog boxes, and functions.

Note that if the height of the MAIN MENU exceeds that of your monitor display, a scroll bar will appear to provide vertical navigation.

MAIN Menu

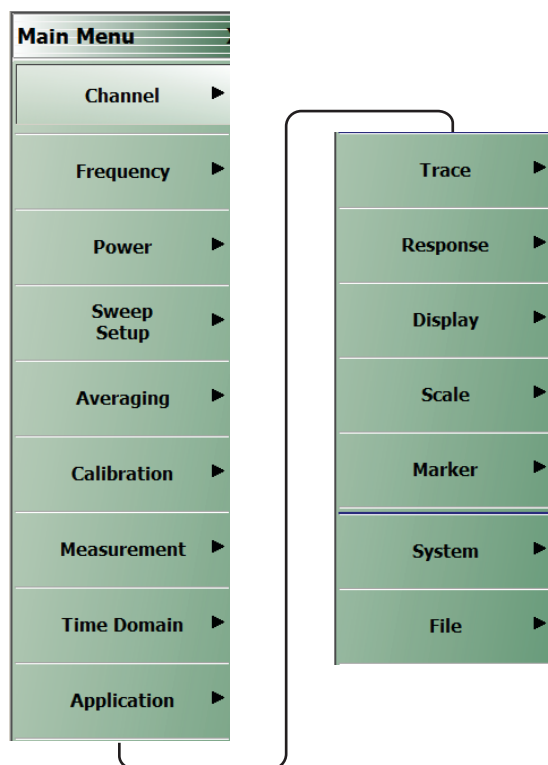

Figure 4-8. MAIN Menu

Frequency

Select displays the FREQUENCY menu. The name, appearance, and available buttons on the FREQUENCY menu varies depending on the sweep type set and if CW frequency is selected.

Power

Select displays the POWER menu.

Sweep Setup

Select displays the SWEEP SETUP menu.

Averaging

Select displays the AVERAGING menu.

Calibration

Select displays the CALIBRATION menu.

Measurement

Select displays the MEASUREMENT menu.

Time Domain

Displays the TIME DOMAIN menu.

Application

Select displays the APPLICATION menu.

Trace

Select displays the TRACE menu.

Response

Select displays the RESPONSE menu.

Display

Select displays the DISPLAY menu.

Scale

Select displays the SCALE menu which allows the user to change the scaling and other attributes of a trace display.

SCALE menu variants are dependent on selections made from TRACE FORMAT menu options.

Marker

Select displays the MARKER [1] menu.

System

Select displays the SYSTEM menu.

File

Select displays the FILE menu.

4-6 Using the Main Menu Interface

Types of Menus, Menu Buttons, and Menu Toolbars

The MAIN MENU (or MAIN) is the right-side navigation function for the instrument. The MAIN MENU has multiple types of menus, menu buttons, and menu toolbars that allow the user to configure and control the operation of the VNA. Each menu consists of the elements shown in the figure below.

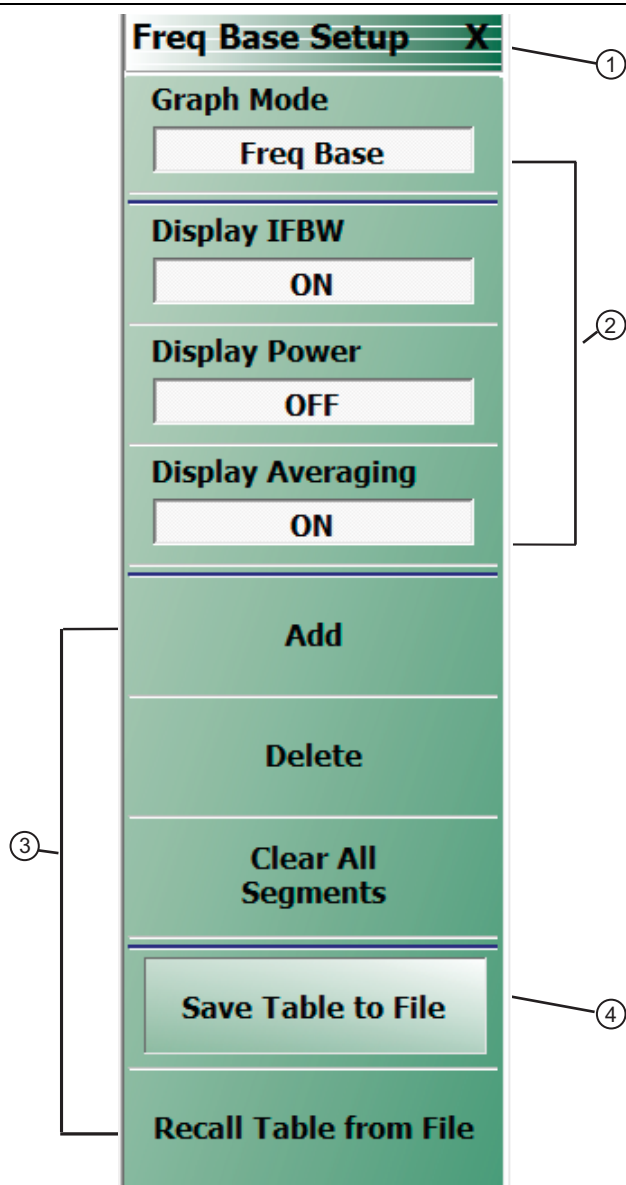

1. Menu Title – Each menu title is unique.

2. Active Selection when highlighted.

3. Field Buttons – The button shows the currently selected value. Selecting the button displays a field toolbar.

4. Menu Buttons – Displays a menu or dialog box.

Figure 4-9. Menu and Button Components

Menu Title

At the top of the menu, a unique menu title, which is not repeated on any other menu. For space reasons, menu names are often abbreviated. For definitions, see [Appendix D, “Abbreviation Glossary”](#).

Menu Buttons

One or more menu buttons that either call a sub-menu, allow for a field value to be specified, toggle a function off or on, or allow a selection to be made from a group of choices. If the menu is longer than one screen, a scroll box and scroll arrows appear on the right side of the menu.

Menu Navigation Buttons

The menu navigation area buttons appear at the bottom of each menu.



Back Button

The Back button returns the menu display to last selected higher-level menu.

Next Button

The Next button returns the menu display to the next deeper sub-menu that has already been selected. The availability of the Back and Next buttons (above) depends on the user's navigation path. The Home button (below) always appears.

Home Button

The Home button returns the menu display to the MAIN MENU.

Menu Buttons

Menu buttons call lower-level menus.

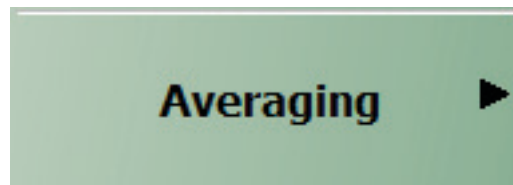

For example, the Averaging button on the MAIN MENU calls the AVERAGING menu.

Read-Only Buttons

Read-only buttons display system values based on other settings and parameters.



For example, the Reset Avg Count button is in a read-only state because the Averaging button is set to OFF.

Function Buttons

Function buttons are used to start a process or to select an option. The buttons are highlighted to indicate selection. Selected options display a radio button icon.



Toggle Buttons

Toggle buttons toggle through two or more values with each click of the button and display their current setting in the button field. For example, in the MAIN MENU | Response | RESPONSE | User Defined | USER DEFINED menu, the Driver Port button displays the default Port 1 setting.



Clicking the Driver Port button toggles to the Port 2 setting.



Clicking the Driver Port button a second time toggles back to the Port 1 setting.

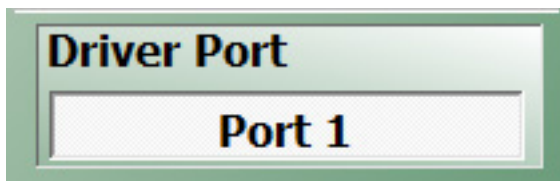

Field Selection Buttons

Field selection buttons display a user-defined parameter or value. Clicking a field selection button such as the Start button on the FREQUENCY menu displays a field toolbar (described below) that allows the user to specify parameter values and units.

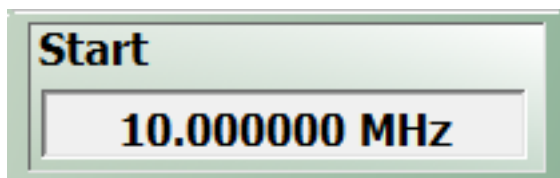

Field Toolbars

Field toolbars appear under the Icon Toolbar after the associated field button has been selected. The field toolbar displays its name, a value field, up/down arrows to increment the value, and one or more unit select buttons.

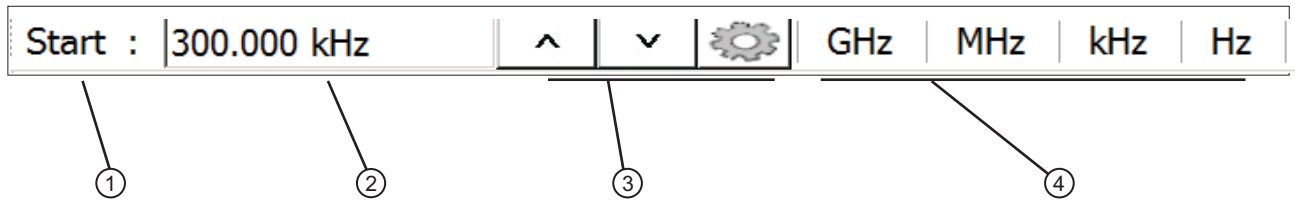

- | | |
|---|--|
| <p>1. Toolbar Name – Normally, the name of the button that invoked the toolbar.</p> <p>2. Value Field – Data entry area for parameter value. Values can be altered by clicking the Up/Down arrows (see item 3) and also from the keyboard Up/Down arrows.</p> | <p>3. Up/Down Arrows and gear icon – These controls, and also the keyboard Up/Down arrow keys, change the field value. The gear icon opens a dialog for adjusting the increment step size.</p> <p>4. Units Selection – Sets units to use. If these controls are not shown, the units are fixed and not selectable.</p> |
|---|--|

Figure 4-10. Field Toolbar Selections

For example, clicking the **Start** button on the **FREQUENCY** menu displays the **Start (Frequency)** field toolbar, with multiple frequency options.



Some field toolbars display a single unit with no options. For example, in the **MAIN MENU | Scale | SCALE** menu, clicking the **Reference Value** button displays the **Reference Value** toolbar with a single dB unit value option.



The system limits for each toolbar are defined in the **System Limits** section in the **Programming Manual Supplement**. The appendix lists the default, minimum allowable, and maximum allowable values and whether the toolbar changes apply on a per-trace, per-channel, or per-system basis.

Button Selection Icon

The button select icon identifies a selected option.



In the example below, the TRACE LAYOUT menu shows that the Single Screen option has been selected.

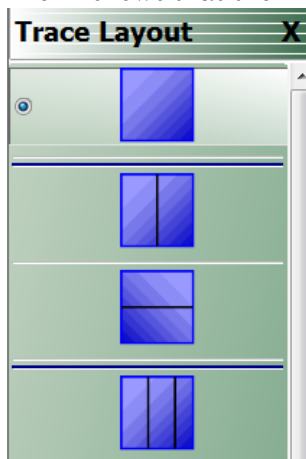

After selection, depending on the menu, the user either clicks the Back button navigation icon to return to the prior menu, or once selected, the system auto-returns to the prior menu.

Navigation

- MAIN | Trace | TRACE LAYOUT | Trace Layout

Completion Checkmark Button

In the CALIBRATION menus, some buttons list the required tasks for each calibration type. The completion checkmark icon indicates that a calibration task has been completed.



For example, in a Full 2 Port Calibration, an option for better performance is an isolation measurement.



The button above left shows the test has not been started. The user makes the necessary physical connections between the VNA and the required connector/adaptor, and then clicks the button to begin the test. The button dims while the test is performed. After the test is successfully completed, the completion icon appears on the left side of the button as shown above right.

Auto-Return Button Groups

Auto-return groups are button selection groups (described above) that automatically return to the higher-level menu after a selection is made.

For example, on the TRACE FORMAT menu shown below (1), clicking on the Impedance button displays the IMPEDANCE menu with its current selection of Real (2). When another selection such as Real & Imaginary is made (3), the system auto-returns to the TRACE FORMAT menu with the Impedance button now set to Real & Imaginary (4).

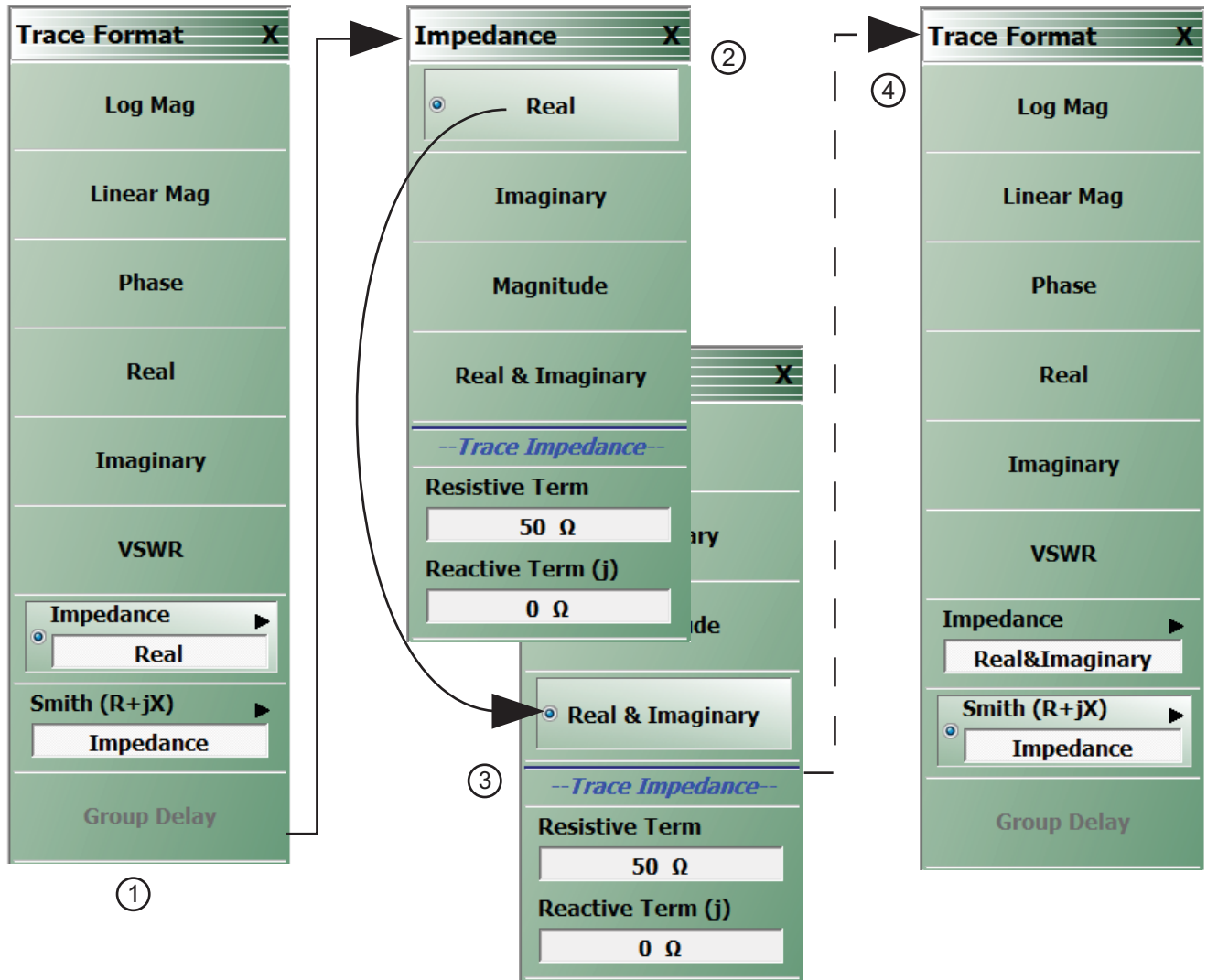

- | | |
|--|--|
| <ol style="list-style-type: none"> Original TRACE FORMAT Menu with Impedance setting as "Real" <ul style="list-style-type: none"> The bottom Impedance field button is set to "Real" Clicking the Impedance button displays the IMPEDANCE menu. Original IMPEDANCE Menu with "Real" <ul style="list-style-type: none"> The IMPEDANCE menu appears with impedance set as "Real." | <ol style="list-style-type: none"> IMPEDANCE Menu with "Real & Imaginary" <ul style="list-style-type: none"> The user selects "Real & Imaginary" and the system auto-returns to the TRACE FORMAT menu. Modified TRACE FORMAT Menu with Impedance setting as "Real & Imaginary" <ul style="list-style-type: none"> The TRACE FORMAT menu automatically re-appears with impedance set as "Real & Imaginary." |
|--|--|

Figure 4-11. Auto-Return Button Group Example on the IMPEDANCE Menu

Completion Checkmark Button

In the CALIBRATION menus, some buttons list the required tasks for each calibration type. The completion checkmark icon indicates that a calibration task has been completed.



For example, in a Full 2 Port Reflection Calibration, one of the required steps is a Port 1 Short test.



The button above left shows the test has not been started. The user makes the necessary physical connections between the VNA and the required connector/adaptor, and then clicks the button to begin the test. The button dims while the test is performed. After the test is successfully completed, the completion icon appears on the left side of the button as shown above right.

4-7 Using Dialog Boxes

Most dialog boxes are standard Microsoft dialog boxes and appear in the center of the display area.

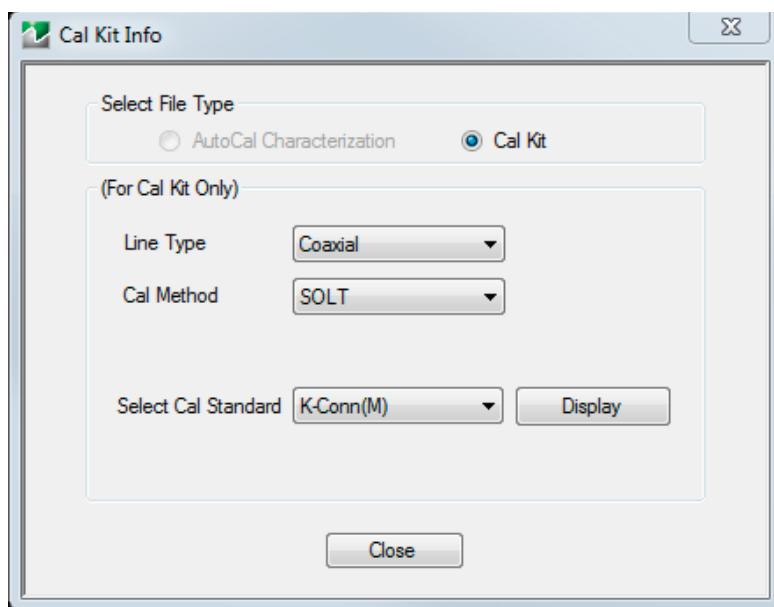

Figure 4-12. CAL KIT INFO Dialog Box Example

Standard Dialog Box Buttons

Most dialog boxes also have some combination of standard buttons for OK, Cancel, and Save. Other buttons and types of buttons may be present. Within dialog boxes are Dialog Box Areas that are usually named for the options that can be selected or the information that is displayed. For example, in the figure above, test status and completion messages are displayed in the Self Test Message area. Most Dialog Box Areas are delimited by a line, box, or shadowbox that contains the information or settings for a series of common attributes. If the area is named in the dialog box, that name is used in any related procedures. If the area is not named, the area is named for the first data or input field. Some dialog boxes have links that call sub-dialog boxes.

4-8 Instrument Status Display Area

At the bottom of the instrument display is the status bar where instrument states and conditions are reported.

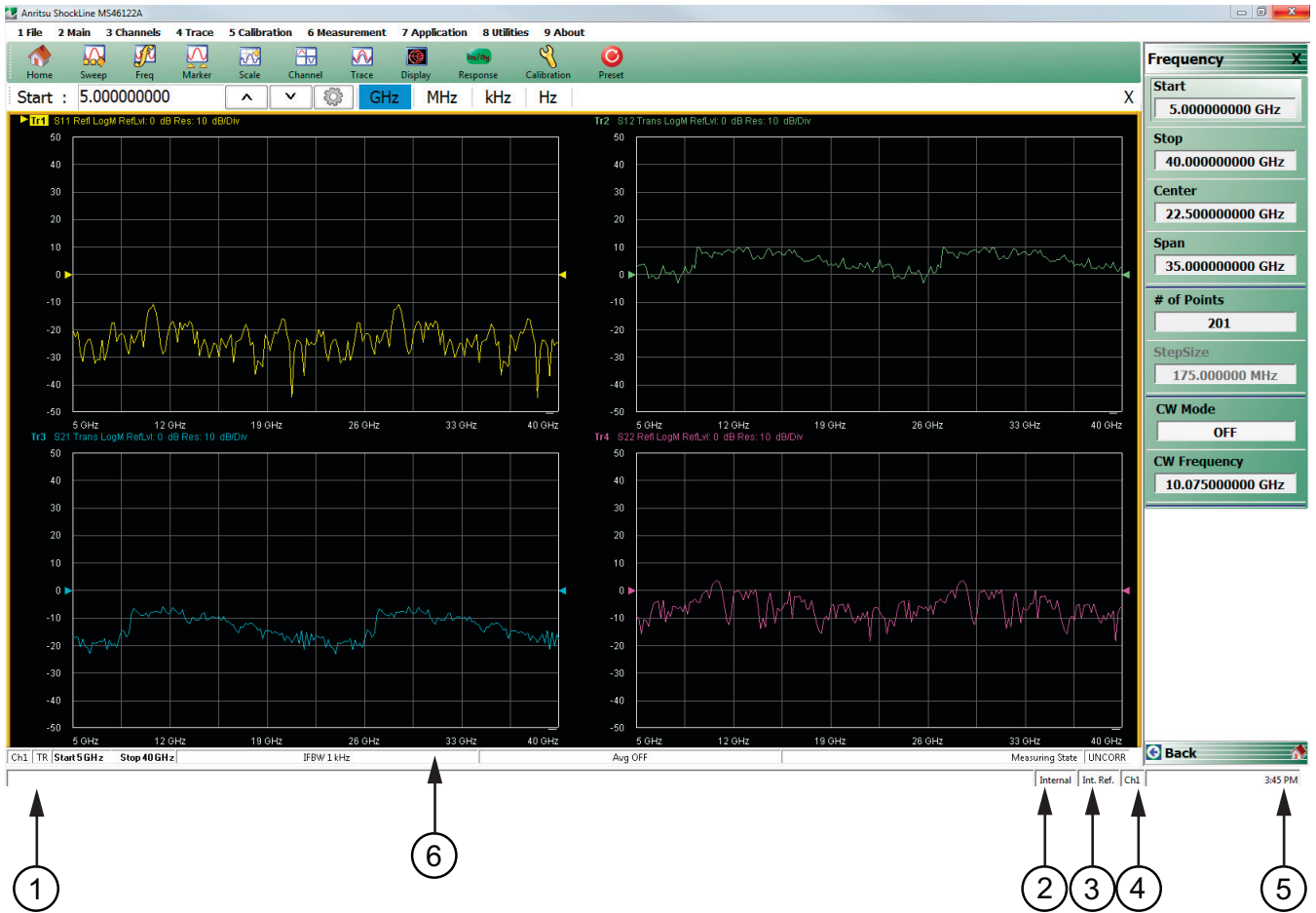

Figure 4-13. Instrument Status Area

Instrument Status Data

Table 4-3. Instrument Status Display Abbreviations

Status Display	Description
1. Warning Messages	Displays warning messages.
2. Internal / External / Manual	Displays status of system triggering.
3. Int. Ref. / Ext. Ref.	Indicates usage of internal or external reference.
4. Port 1 / Port 2 / Port 3 / Port 4	Highlights the port being driven: <ul style="list-style-type: none"> • 2-Port VNAs cycle between Port 1 and 2. • 4-Port VNAs cycle between 1 and 4.
5. Time	Displays system time.
6. Channel Status bar	See “Channel Status Display Area”.

4-9 Channel Status Display Area

At the bottom of the display (just above the Instrument Status display area) is the Channel Status display area, where the information shown in Table 4-4 is reported. The displayed parameters are context and setting dependent. Not all parameters are displayed all the time. In a multi-channel display, the display may be truncated. To maximize the channel display, select any of the following:

- Keyboard: **CTRL + 1**
- Keyboard: **ALT + 3, then 2**
- MAIN | Channel | CHANNEL | Chan. Max

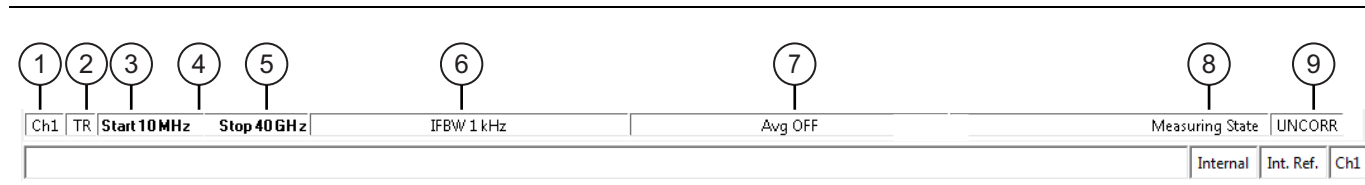

Figure 4-14. Channel Status Bar

Table 4-4. Channel Status Bar Abbreviations

	Status Display	Description
1	Ch#	Displays the channel number. For example, Ch2 means that the display is for Channel 2.
2	TR	Displays the measurement mode as transmission/reflection.
3	[Start] Start # Units	In general, the left-side parameters define the starting position of distance, frequency, time, or power. From the FREQUENCY menu, if CW Mode is set to off, displays the current Start Frequency value with units of kHz, MHz, or GHz.
4	CW Frequency # Units	From the FREQUENCY menu, if CW Mode is set to on, displays the current CW Frequency value with units of kHz, MHz, or GHz.
5	[End] Stop # Units	In general, the right-side parameters define the ending position of distance, frequency, time, or power. From the FREQUENCY menu, if CW Mode is set to off, displays the current Stop Frequency value with units of kHz, MHz, or GHz.
6	IFBW # Units	From the AVERAGING menu, reports the IF Bandwidth Frequency setting with units of Hz, kHz, or MHz.
7	Avg OFF Avg # # / #	From the AVERAGING menu, reports that Averaging is off, or if values are present, Averaging is on. If Averaging is on, and the Averaging Type is Per-Point, reports the Averaging factor. If Averaging is on, and the Averaging Type is Per-Sweep, the left-side number reports the number of average sweeps; the right-side number displays the Averaging Factor.
8	Measuring State Calibrating State	Indicates whether the instrument is measuring or being calibrated.
9	UNCORR CORR EDE E/O	UNCORR indicates that a calibration is not being applied. CORR (with a green background) indicates that the calibration for the active channel is being applied (corrected). EDE (with green background) Indicates Embedding or De-embedding is being applied. E/O, O/E, or O/O (with a green background) indicates an optical measurement state.

4-10 Working with Channels

Each VNA channel is like a separate VNA, with its own frequency list, calibrations, power setup and other parameters. Each channel can display up to 16 individual trace graph displays. The number of VNA channels is user-definable up to a maximum of 16 channels.

Channel Menu

Navigation to the CHANNEL menu:

MAIN MENU | Channel | CHANNEL |



Figure 4-15. Channel Menu

To Select a Channel

1. Select a channel in a multi-channel display by doing one of the following:
 - Click anywhere inside the desired channel box.
 - From the keyboard, enter **ALT + 3**, then **3** to view the previous channel or **ALT + 3**, then **4** to view the next channel.
 - On the top menu bar, select Menu Bar | Channels | Channel Prev or Menu Bar | Channel | Channel Next.
 - On the right side menu, select MAIN | Channels | CHANNELS | Chan Next or Chan Previous.
2. The selected channel border changes from gray to white. (Figure 4-3, “User Interface - 12 Traces (simulated data)” on page 4-3 shows Channel 2 (Ch2) selected.)

Note

The **Ch->Max**, **Ch->Next**, and **Ch->Prev** icons are available for the Icon toolbar. These icons provide one click access to channel maximum, channel next, and channel previous functions. They can be added to the Icon toolbar for a custom configuration and saved as part of a preset configuration.

To Maximize a Channel Display

1. Use one of the methods above to select the desired channel.
2. Do one of the following to maximize the selected channel:
 - From the keyboard, enter **CTRL + 1** or **ALT + 3**, then **2**.
 - On the main display, double-click the channel border box.

- On the top menu bar, select **Menu Bar | Channel | Channel Max**.
 - On the right side menu, select **MAIN | Channel | CHANNEL | Chan. Max**.
3. The selected channel now fills the display area.
- Maximize a channel display to review the channel status information at the bottom of its screen.

To Make the Display Area Larger

1. The top icon toolbar and the right side menus can be removed to make the display area larger.
2. Remove the icon toolbar by doing one of the following:
 - From the keyboard, select **ALT + 8**, then **2**.
 - On the top menu bar, select **Menu Bar | Utilities | Toolbar Off**.
3. The icon toolbar disappears. Repeat **Step #2** to make the icon toolbar reappear.
4. Remove the right side menus by doing one of the following:
 - From the keyboard, enter **ALT + 8**, then **7**.
 - On the top menu bar, select **Menu Bar | Utilities | Clear**.

The right side menu disappears. Repeat **Step #4** to make the menu reappear.

To Select Traces

1. Use one of the methods above to maximize the channel display.
2. Select a trace in a multi-trace display by doing one of the following:
 - With a mouse, single click the trace title.
 - If you double-click either the trace title or anywhere within the trace, the trace is both selected and maximized.
 - From the keyboard, enter **ALT + 4**, then **7** to view the previous trace or **ALT + 4**, then **8** to view the next trace.
 - On the top menu bar, select **Menu Bar | Trace | Trace Prev** or **Menu Bar | Trace | Trace Next**.
 - On the right side menu, select **MAIN | Trace | TRACE | Trace Previous** or **Trace Next**.
 - The selected trace number is highlighted and a left arrow appears.

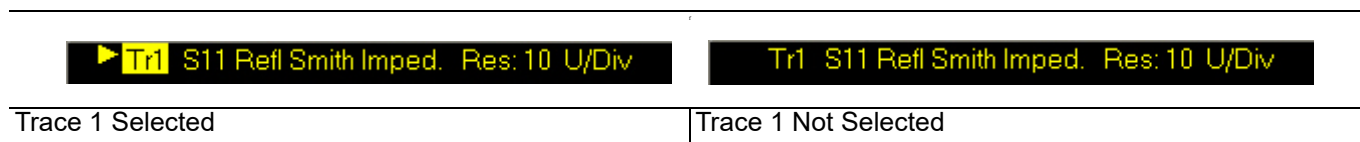

Figure 4-16. Trace Selection Indicator

Note	The Tr->Max , Tr->Next , and Tr->Previous icons are available for the Icon toolbar. These icons provide one click access to trace maximum, trace next, and trace previous functions. They can be added to the icon toolbar for a custom configuration and saved as part of a preset configuration.
-------------	--

To Maximize a Trace Display

1. Use one of the methods above to select the desired trace.
2. For a maximum display, make sure the trace's channel is maximized.
3. Do one of the following to maximize the selected trace:
 - From the keyboard, select **ALT + 4**, then **6**.
 - On the main display, double-click anywhere in the trace display.
 - On the top menu bar, select **Menu Bar | Trace | Trace Max**.
 - On the right side menu, select **MAIN | Trace | TRACE | Trace Max**.

4. The selected trace now fills the display area.
 - Maximize a trace display to review the trace status information at the bottom of trace screen.
5. Repeat the actions above to return the trace to its normal size.

4-11 Working with Traces

For each channel defined above, from 1 (one) to 16 trace graphs (called “traces”) can be defined where each trace is a data display within a specific channel. Each trace is defined by a response parameter (such as S11), a graph type display (such as a rectilinear graph, a polar display or Smith chart), a scale, and possibly post-processing elements such as time domain and smoothing.

Trace Menu

Navigation to the TRACE Menu:

MAIN MENU | Trace | TRACE |

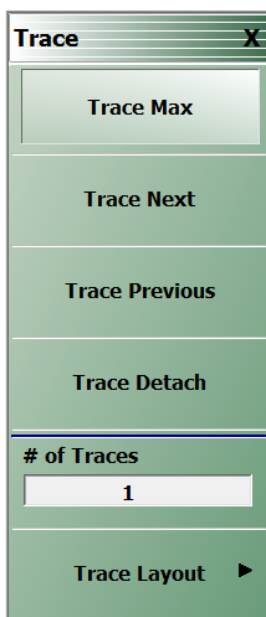

Figure 4-17. Trace Menu

To Select Traces

1. Use one of the methods above to maximize the channel display.
2. Select a trace in a multi-trace display by doing one of the following:
 - With a mouse, single click the trace title.
 - If you double-click either the trace title or anywhere within the trace, the trace is both selected and maximized.
 - From the keyboard, enter **ALT + 4**, then **7** to view the previous trace or **ALT + 4**, then **8** to view the next trace.
 - On the top menu bar, select Menu Bar | Trace | Trace Prev or Menu Bar | Trace | Trace Next.
 - On the right side menu, select MAIN | Trace | TRACE | Trace Previous or Trace Next.
 - The selected trace number is highlighted and a left arrow appears.

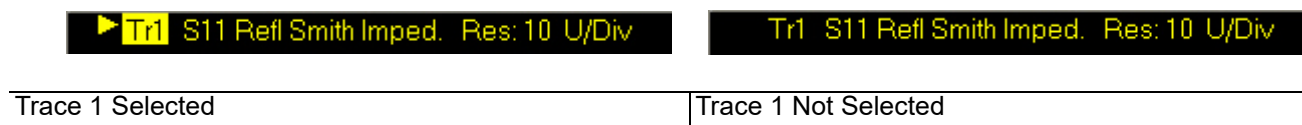

Figure 4-18. Trace Selection Indicator

Note	The Tr->Max , Tr->Next , and Tr->Previous icons are available for the icon toolbar. These icons provide one click access to trace maximum, trace next, and trace previous functions. They can be added to the icon toolbar for a custom configuration and saved as part of a preset configuration.
-------------	--

To Maximize a Trace Display

1. Use one of the methods above to select the desired trace.
2. For a maximum display, make sure the trace's channel is maximized.
3. Do one of the following to maximize the selected trace:
 - From the keyboard, select **ALT + 4**, then **6**.
 - On the main display, double-click anywhere in the trace display.
 - On the top menu bar, select Menu Bar | Trace | Trace Max.
 - On the right side menu, select MAIN | Trace | TRACE | Trace Max.
4. The selected trace now fills the display area.
 - Maximize a trace display to review the trace status information at the bottom of trace screen.

Repeat the actions above to return the trace to its normal size.

Types of Trace Displays

There are four general graph types available and within each general type are multiple sub-types:

- Rectilinear single graph
- Rectilinear dual graph
- Smith chart

Trace Data Types

The data types generated by the VNA (real, imaginary, magnitude, phase) are used in the display graph to show the possible ways in which S-Parameter data can be represented. For example, complex data, that is data in which both phase and magnitude are graphed, may be displayed in any of the following ways:

- **Complex Impedance**
Displayed on a Smith chart graph as impedance or as admittance.
- **Real and Imaginary**
If simultaneous displays are required, displayed on a real and imaginary rectilinear (a Cartesian plot) graph. If only one type is required, a single rectilinear real graph or single rectilinear imaginary graph.
- **Phase and Magnitude**
Displayed on a single rectilinear graph, as paired rectilinear graphs, or as a polar graph.
- **Group Delay**
Defined as the frequency span over which the phase change is computed at a given frequency point. The quantity group delay is displayed using a modified rectilinear-magnitude format. In this format, the vertical scale is in linear units of time (either ps, ns, us, or ms). With one exception, the reference value and reference line functions operate the same as they do with a normal magnitude display.

Trace Display Graphs

A separate graph can be assigned to each active channel and display area. The following available display graph types are listed in [Table 4-5](#) below.

Table 4-5. Available Trace Display Types (1 of 3)

Menu Name	Definition and Display Options	Y-Axis Dependent Variable	X-Axis Independent Variable	Measurement Applications
Rectilinear Single Graphs				
Log Mag	Log magnitude rectilinear format graph Magnitude		Y = dB	Return loss measurement Insertion loss measurement Gain measurement
Linear Mag	Linear magnitude rectilinear format graph	Magnitude	Linear units	Reflection coefficient measurement
Phase	Phase rectilinear format graph	Phase displayed in range from -180 to + 180 degrees	Degrees	Linear phase deviation measurements
Imaginary	Imaginary rectilinear format graph	Imaginary part of measured complex parameter	Linear units	
Real	Real rectilinear format graph	Real part of measured complex parameter	Linear units	
SWR	Standing Wave Ratio rectilinear format graph	$SWR = \frac{1 + \rho}{1 - \rho}$ where ρ = Reflection Coefficient	Linear units	Standing wave measurements Antenna analysis
Impedance	Impedance rectilinear format graph Four options are: • Real • Imaginary • Magnitude • Real & Imaginary • Inductance • Capacitance			

Table 4-5. Available Trace Display Types (2 of 3)

Menu Name	Definition and Display Options	Y-Axis Dependent Variable	X-Axis Independent Variable	Measurement Applications
Smith Chart Graphs				
Smith (R + jX)	Smith Chart graphs with impedance (circuit resistance and reactance) Four read out style options are available: <ul style="list-style-type: none"> • Lin/Phase • Log/Phase • Real/Imag. • Impedance 		The impedance is the measure of a circuit's opposition to alternating current which consists of the circuit resistance and the circuit reactance, together they determine the magnitude and phase of the impedance.	<ul style="list-style-type: none"> • Reflection measurements
Rectilinear Paired Graphs				
Log Magnitude and Phase	Paired graphs with Log Magnitude on top and Phase on bottom	As above	As above	Same as having one trace with a Log Magnitude display and a second trace with a Phase rectilinear display.
Linear Magnitude and Phase	Paired graphs with Linear Magnitude on top and Phase on bottom	As above	As above	Same as having one trace with a Linear Magnitude display and a second trace with a Phase rectilinear display.
Real and Imaginary	Paired graphs with Real on top and Imaginary on bottom	As above	As above	Same as having one trace with a Real rectilinear display and a second trace with an Imaginary rectilinear display.
Group Delay / Power Graphs				
Group Delay	Displays the time lag through a DUT measured in ps, ns, us, or ms.	Time measured in ps, ns, us, or ms.	Frequency	Bandpass filter design Transmission studies

Table 4-5. Available Trace Display Types (3 of 3)

Menu Name	Definition and Display Options	Y-Axis Dependent Variable	X-Axis Independent Variable	Measurement Applications
Max Efficiency Display Type				
When using Max Efficiency response type, a new set up Display types are available. They can be displayed as both Rectilinear Single graph or Rectilinear Paired graph				
Rectilinear Single Graphs				
kQ	Displays the kQ product of the coupling coefficient k and the Quality factor Q	Dependent Variable	Independent Variable	Frequency Measurement Applications Wireless power transfer
n Max	Displays the maximum efficiency Y-Axis Dependent Variable	Dependent Variable	Independent Variable	Frequency Measurement Applications Wireless power transfer
Rectilinear Paired Graphs				
kQ	Displays the kQ product of the coupling coefficient k and the Quality factor Q	Dependent Variable	Independent Variable	Frequency Measurement Applications Wireless power transfer
n Max	Displays the maximum efficiency Y-Axis Dependent Variable	Dependent Variable	Independent Variable	Frequency Measurement Applications Wireless power transfer

Each graph type is described in greater detail below with sample graphs, and explanation of supporting trace displays.

Trace Labels

Each trace (i.e. each graph display) is labeled with information such as its trace number, the graph type, scaling, reference delay, and S-parameter associated with that trace. Depending on the trace settings and the graph type, other information may be displayed. The Trace number field can be edited for a custom trace name.

The general format of trace label consists of the following parameters and their associated abbreviations appearing from left to right in the trace label. Some parameters may not appear depending on the instrument settings.

- Trace Number
- Measurement Type
- Time Domain
- Graph Type
- Reference Level
- Resolution Units
- Trace Memory Statistics

Trace Label Abbreviations

The trace label abbreviations are described in the three tables below:

- [Table 4-6, "Trace Labels - Trace Number, Measurement Type"](#)
- [Table 4-7, "Trace Labels - Abbreviation, Type and Name, Reference Level Units, Resolution Units"](#)

Table 4-6. Trace Labels - Trace Number, Measurement Type

Abbreviation	Definition	Description
Trace Number Abbreviation		
Tr#	Trace number	Trace 1 through Trace 16.
Measurement Type Abbreviations		
S11 Refl	S11 Port 1 forward reflection	S-parameters are selected on the RESPONSE menu.
S12 Trans	S12 Port 1 reverse transmission	
S21 Trans	S21 Port 2 forward transmission	
S22 Refl	S22 Port 2 reverse reflection	
NN / DD Port #	NN is user-defined numerator value. DD is user-defined denominator value. Port number	User-defined numerator, denominator, and driver port are selected on the RESPONSE User-defined USER-DEFINED menu. Numerator and denominator options are A1, B1, A2, B2, or 1 Port number selection options are Port 1 or Port 2.
[EQN]	Equation Editor	If using Equation Editor, [EQN] notation will show.

Table 4-7. Trace Labels - Abbreviation, Type and Name, Reference Level Units, Resolution Units

Graph Abbreviation	Graph Name and Type	Reference Level (RefLvl)	Resolution Units (Res)
Rectilinear Single Graph			
LogM	Log Mag (Log Magnitude) rectilinear	dB	dB / Div
LinM	Linear Mag (Linear Magnitude) rectilinear	U	U / Div
Phase	Phase rectilinear with units in degrees (°)	°	° / Div
Real	Real rectilinear	U	U / Div
Imag	Imaginary rectilinear	U	U / Div
SWR	SWR rectilinear	U	U / Div
Imped Real	Impedance Real rectilinear with units in Ohms (Ω)	Ω	Ω / Div
Imped Imag	Impedance Imaginary rectilinear	Ω	Ω / Div
Imped Mag	Impedance Magnitude rectilinear	Ω	Ω / Div
Imped R + I	Impedance Real and Imaginary rectilinear. A rectilinear paired graph.	Ω	Ω / Div
Smith Charts with Impedance			
Smith Imped	The display can be one of four possible Smith Chart with impedance displays: <ul style="list-style-type: none"> • Smith (R+jX) Linear/Phase Smith Chart • Smith (R+jX) Log/Phase Smith Chart • Smith (R+jX) Real/Imaginary Smith Chart • Smith (R+jX) Impedance Smith Chart 	—	U / Div
Rectilinear Paired Graphs			
LogM + P	Log Magnitude and Phase rectilinear paired graphs.	dB	° Res: dB/Div, °/Div
LinM + P	Linear Magnitude and Phase rectilinear paired graphs	dB	° Res: dB/Div, °/Div
R + I	Real and Imaginary rectilinear paired graphs	U	Res: U/Div, U/Div
Group Delay and Power Rectilinear Graphs			
Grp Dly	Group Delay rectilinear with units of seconds	s	Res: s/Div

Rectilinear Single Graph

A rectilinear graph is a display of a Cartesian coordinate system or plan consisting of an X-axis and a Y-axis. The X-axis displays the independent variable (such as frequency or time) and the Y-axis displays the dependent value

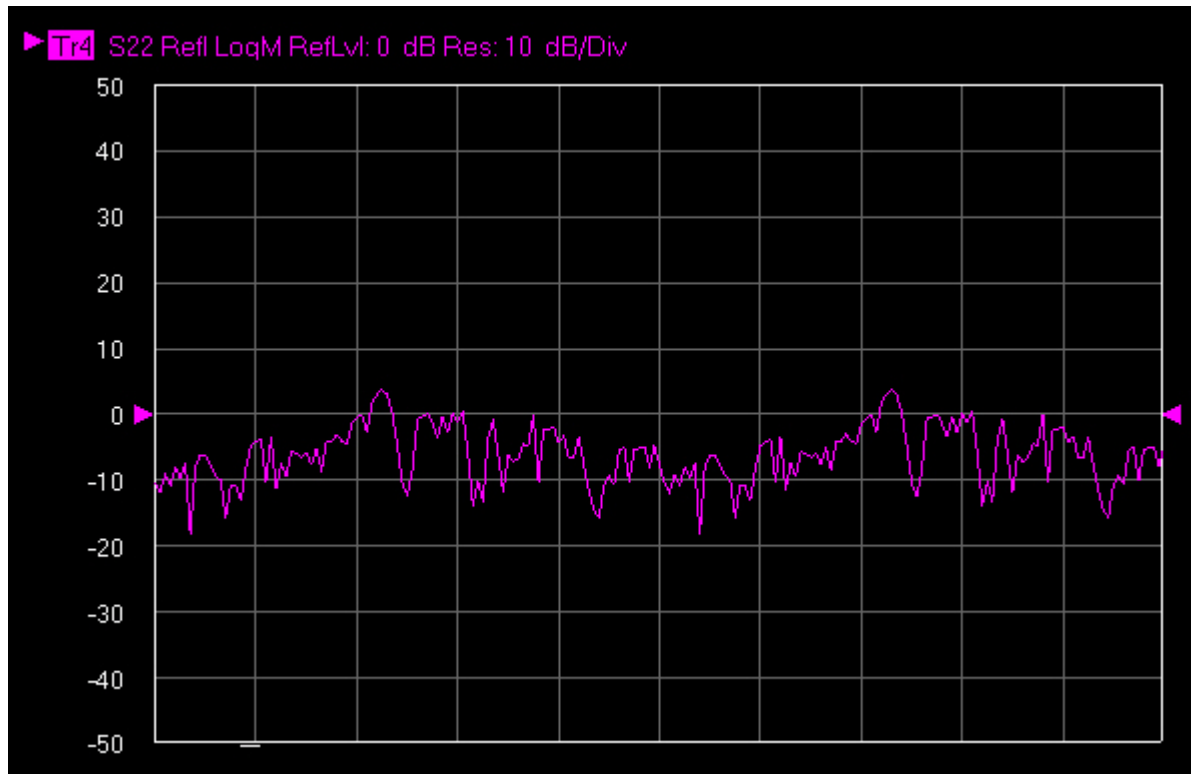

Figure 4-19. Trace Graph - Rectilinear Single - Log Magnitude (Log Mag) Trace Display Graph

Rectilinear Paired Graphs

As above, but paired with a phase rectilinear graph below. Useful to provide immediate comparison with a function value and its phase.

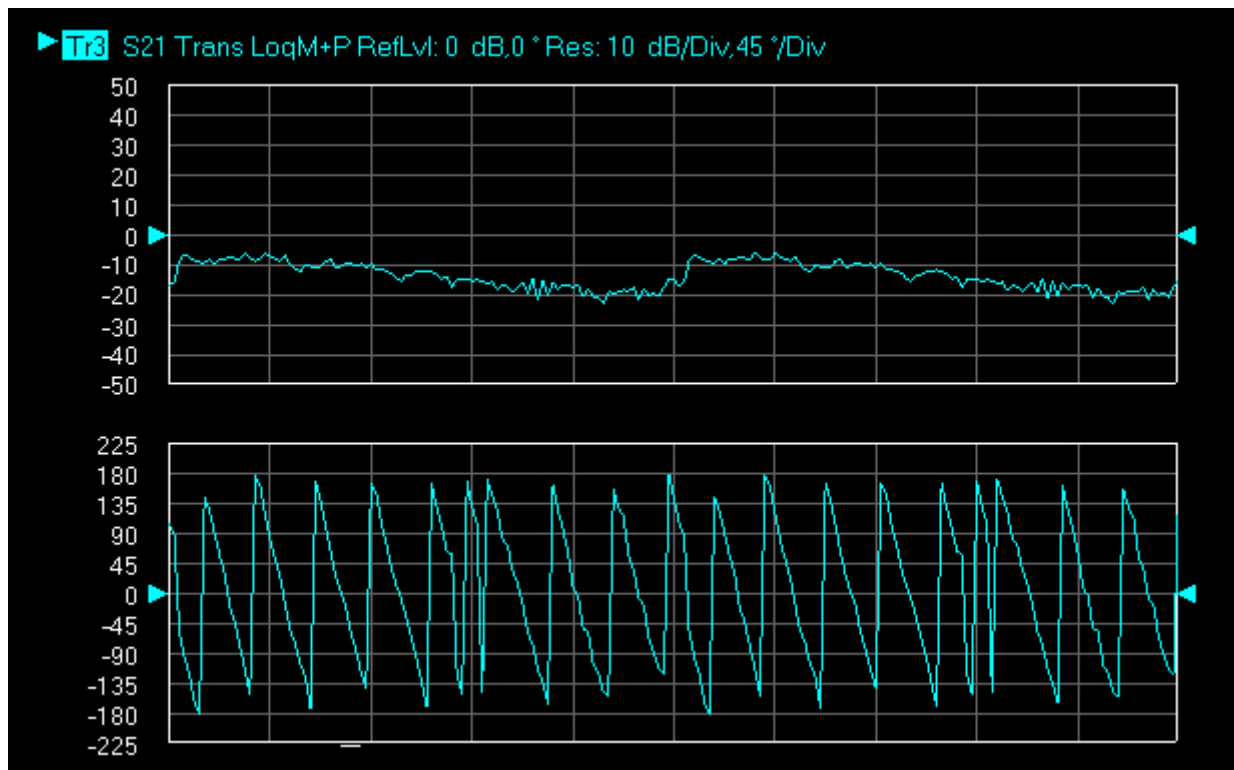

Figure 4-20. Trace Graph - Rectilinear Paired - Trace Log Magnitude and Phase Trace Display

Smith Charts

The power reflected from a DUT has both magnitude and phase because the impedance of the device has both a resistive and a reactive term of the form $r+jx$. We refer to the r as the real or resistive term, while we call x the imaginary or reactive term. The j , which we sometimes denote as i , is an imaginary number. It is the square root of -1 . If x is positive, the impedance is inductive, if x is negative the impedance is capacitive. The size and polarity of the reactive component x is important in impedance matching. The best match to a complex impedance is the complex conjugate which means an impedance with the same value of r and x , but with x of opposite polarity. This term is best analyzed using a Smith Chart, which is a plot of r and x .

To display all the information on a single S-parameter requires one or two traces, depending upon the format we want. A very common requirement is to view forward reflection on a Smith Chart (one trace) while observing forward transmission.

Smith Chart with Impedance (Circuit Resistance and Reactance)

The Smith Chart with impedance (Smith $R + jX$) has four display options:

- Lin/Phase
- Log/Phase
- Real/Imag.
- Impedance

The impedance is the measure of a circuit's opposition to alternating current which consists of the circuit resistance and the circuit reactance, together they determine the magnitude and phase of the impedance.

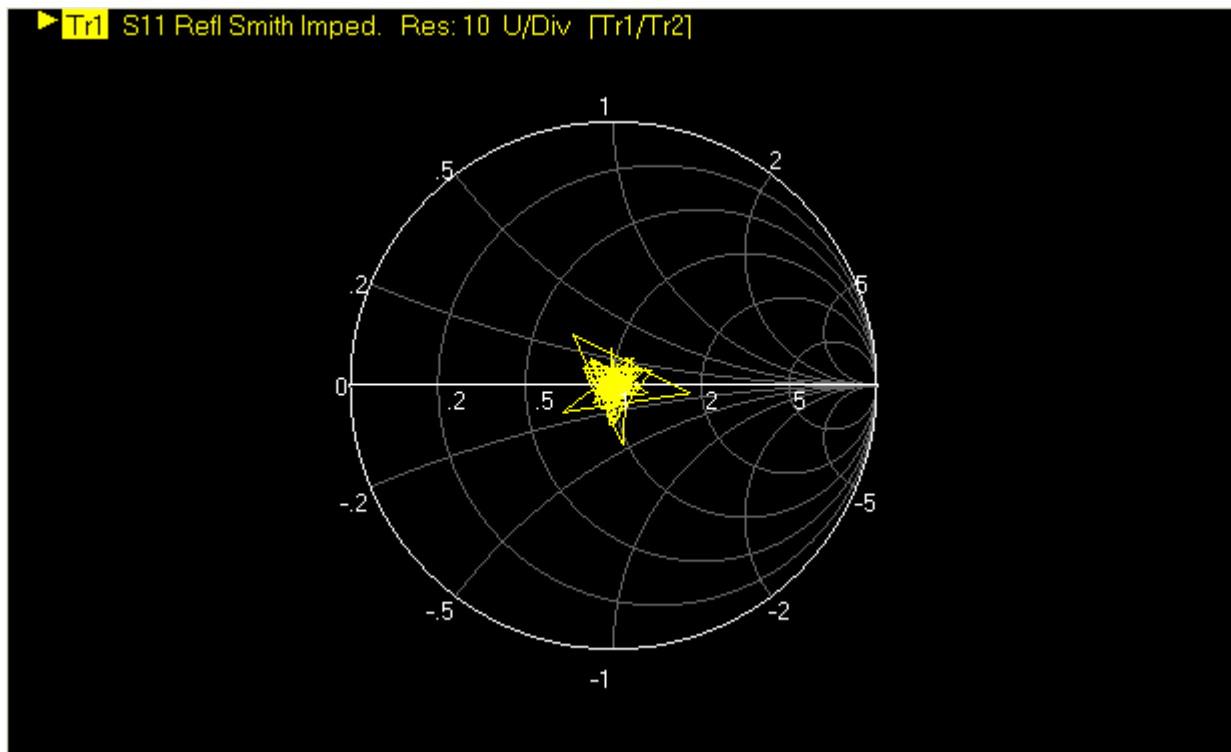

Figure 4-21. Smith Chart with Impedance (R+jX)

Group Delay Graphs

The quantity group delay is displayed using a modified rectilinear-magnitude format. In this format the vertical scale is in linear units of time (ps, ns, us, ms). With one exception, the reference value and reference line functions operate the same as they do with a normal magnitude display. The exception is that they appear in units of time instead of magnitude.

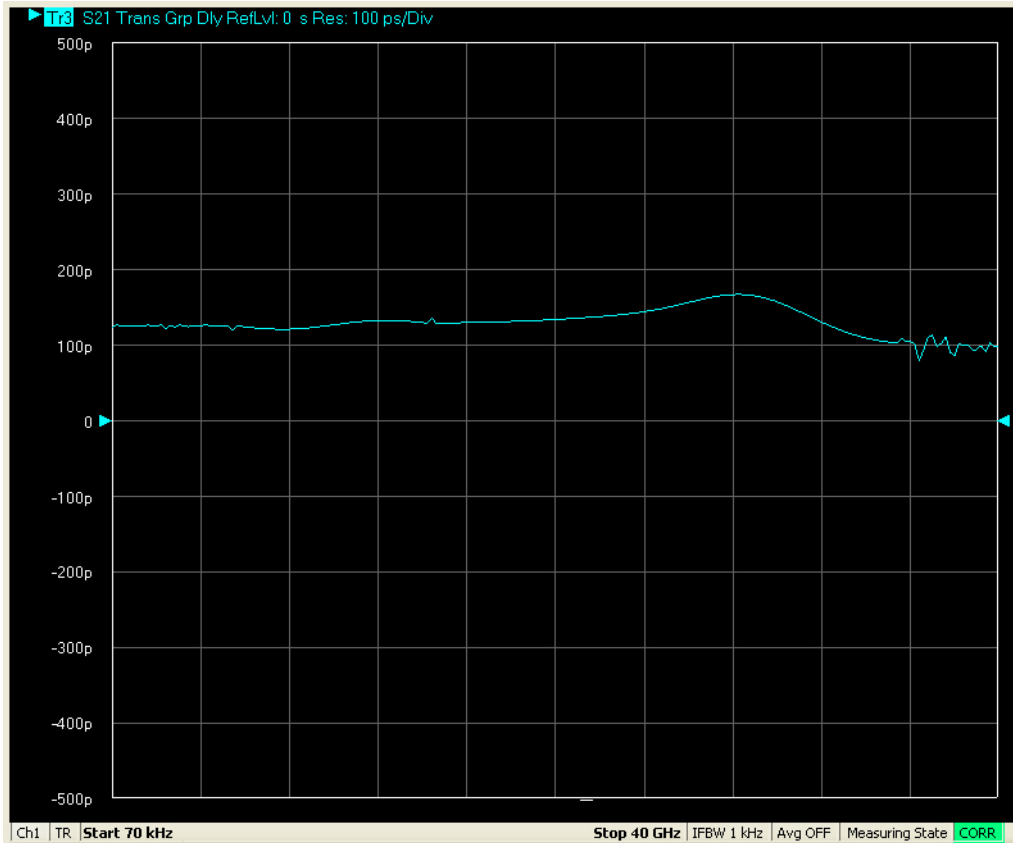

Figure 4-22. Group Delay Trace Graph Example

Polar Graphs

A polar graph represents a two-dimensional coordinate system where each point is determined by an angle and a distance. The polar coordinate system is especially useful in situations where the relationship between two points is most easily expressed in terms of angles and distance such as in phase relationships in antenna and feed-line design. The magnitude parameter can use either a linear or log scale. As the coordinate system is two-dimensional, each point is determined by two polar coordinates: the radial coordinate (distance from the center) and the angular coordinate (degrees counterclockwise from the right edge). Polar displays are used for transmission measurements, especially for cascaded devices in series. The transmission result is the addition of the phase and log magnitude (dB) information in the polar display of each device.

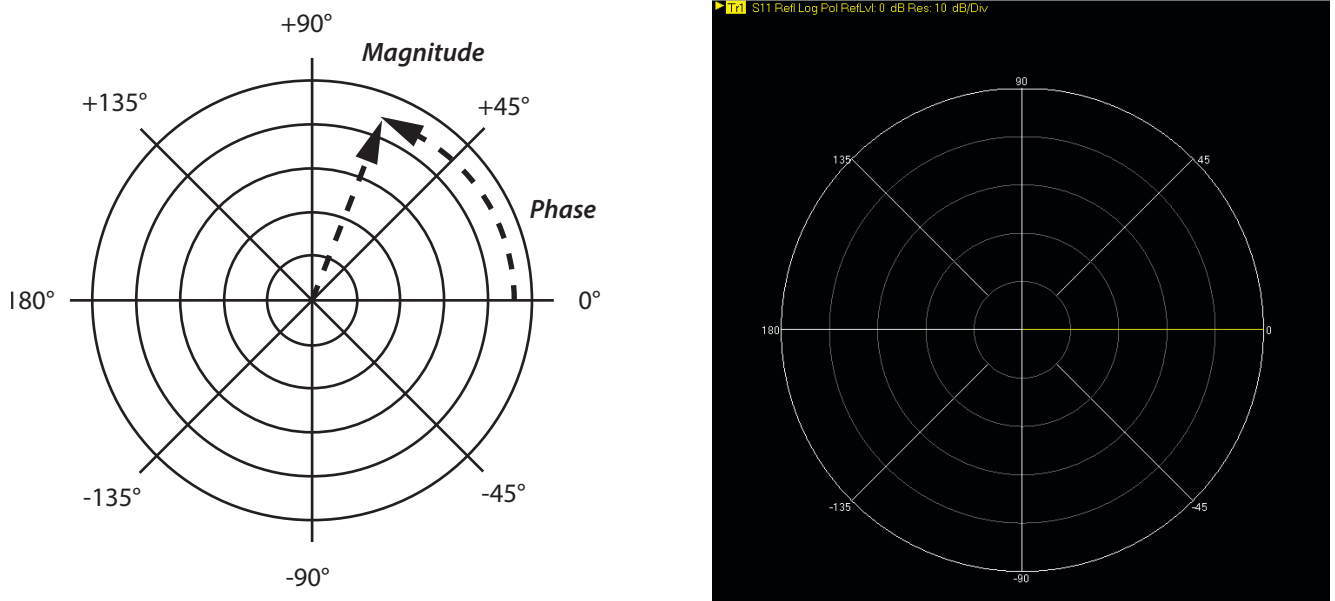
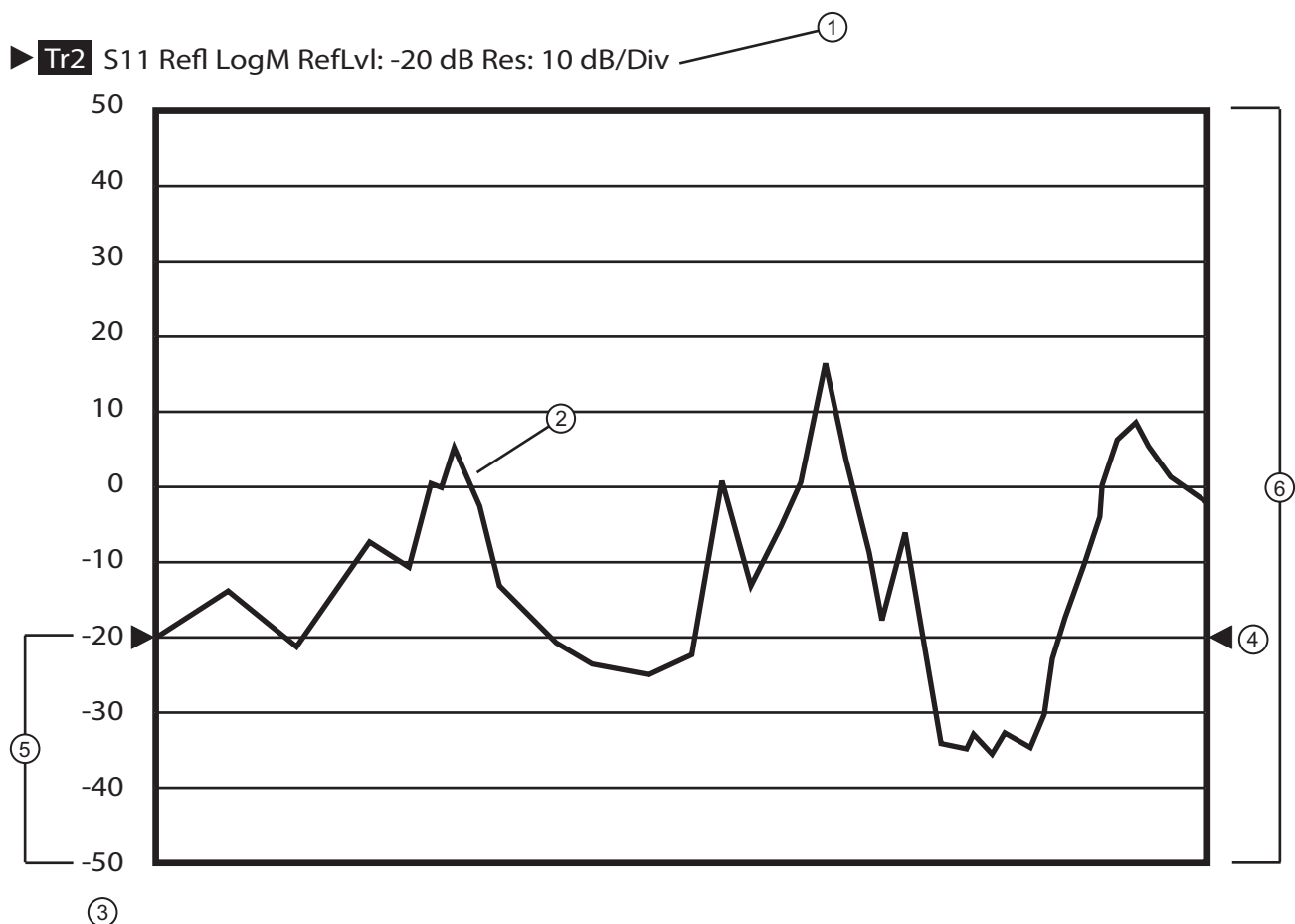

Figure 4-23. Log Polar Diagram and Trace Graph Example

4-12 Working with Reference Lines and Reference Position

You can manipulate the display elements in a rectilinear trace graph from either the trace itself or from the right-side menus.



1. Trace Label – The trace label appears above the trace graph. The example above shows Trace 2 measuring S11, displayed on a Log Magnitude graph, with a Reference Level of -20 dB, and a graph resolution of 10 dB per vertical division.
2. Response Graph – A typical S11 response graph.
3. Resolution in Units per Division – The example shows 10 dB per division.

4. Reference Line Pointers – Reference lines are only available in rectilinear trace graphs and are indicated by the paired arrows on the trace graph display and show the position of the reference value on the Y-axis scale. The example Reference Value is set to -20 dB. Click-hold-and-drag the line pointers to change the reference line value.
5. Reference Position – The example Reference Position is set to 3. Click-hold-and-drag the reference position scale to change the position of the graph on the Y-axis up or down. The value of the Reference Line Points does not change.
6. Number of Vertical Divisions – The example number of vertical divisions is set to 10.

Figure 4-24. Trace Display Controls and Settings

4-13 Working with Markers

The ShockLine VNA GUI display provides up to thirteen markers per trace of which twelve are direct markers and one a reference marker. Each marker data array can be repositioned by a drag/drop anywhere within the signal response trace display. Each marker can be individually controlled on/off and positioned as required on the signal response display.

If the reference marker is off, each marker provides measurement data based on its display position. If the reference marker is on, each marker provides differential measurement data based on its position relative the reference. [Figure 4-25](#), is an overview of the marker menu.

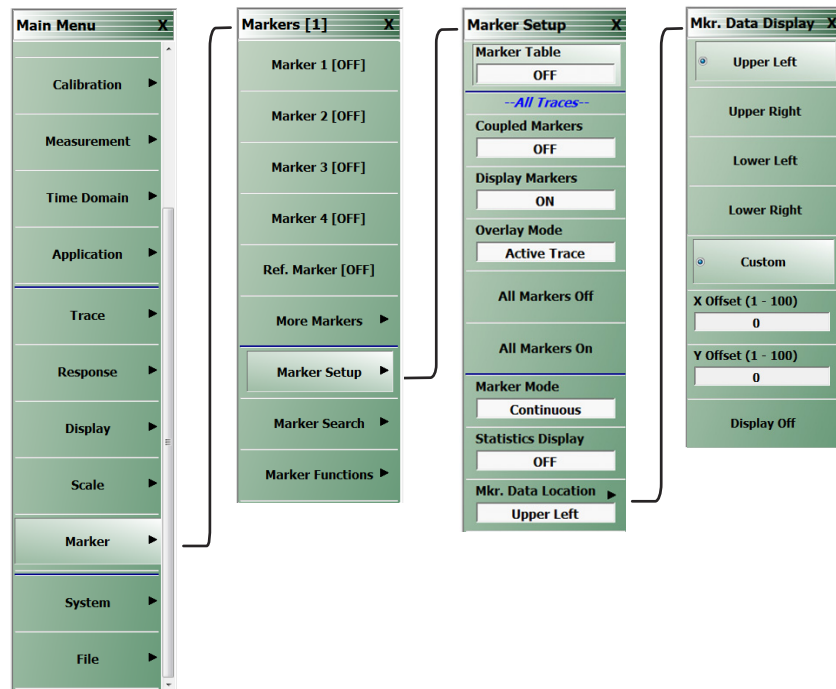
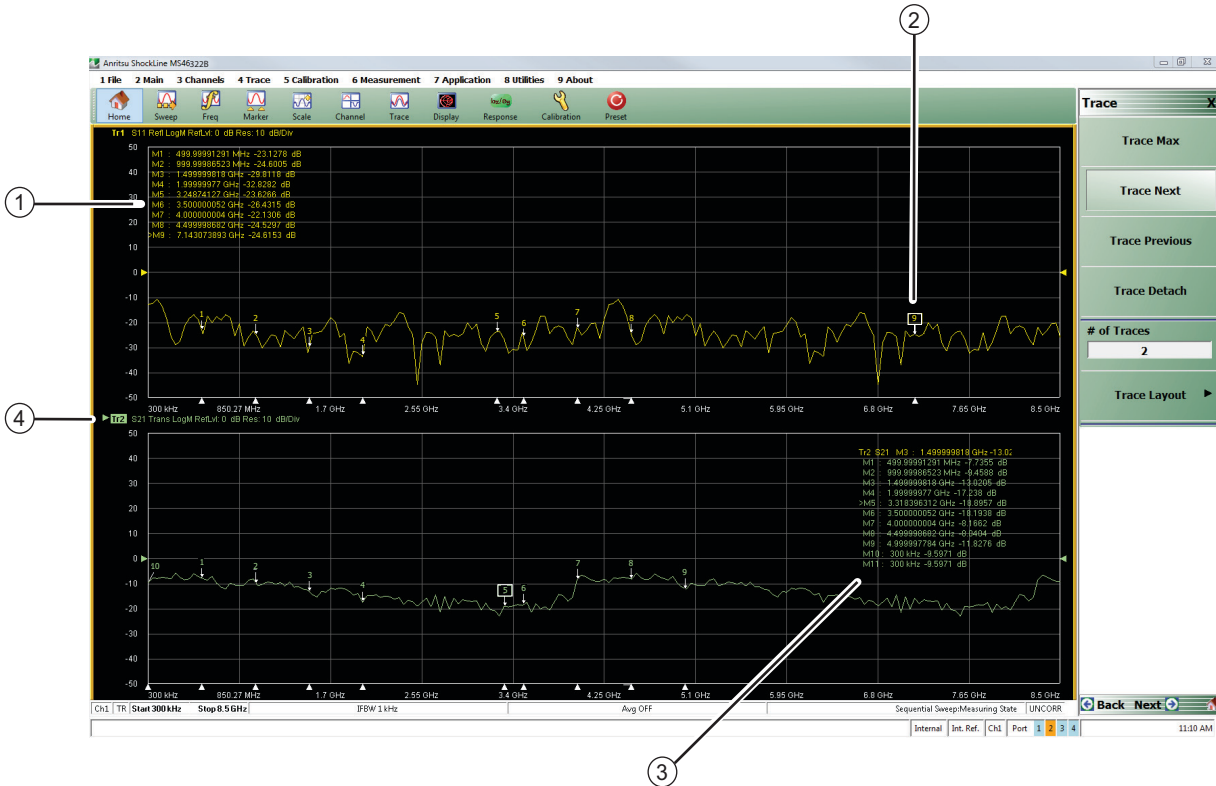

Figure 4-25. Marker Menu

Markers

- Can be set between Discrete and Continuous Modes
- Can be set to Statistics Display.
- Can be set to Coupled mode on or off.
- Can be set to be repositioned within the display.
- Can be set to search Bandwidth Loss field and Notch Loss field.
- Can set Tableau Display to view all active markers.
- Can set Marker Labels.
- Can search Target Markers.
- Can search range units depending on the Sweep Types selected.

The example below [Figure 4-26](#), depicts a two trace display. On the top trace display, the individual marker [9] is selected, and repositioned. In the bottom trace, the marker data display is repositioned. The marker(s) can be repositioned while using any parameter setup menu. Note that the marker data display placement area on the main display window may be limited if the detachable trace view windows in use are smaller in size than then the main display window.



- | | |
|---|---|
| 1. Trace 1 marker data display with nine active markers | 3. Trace 2 marker data display with 11 active markers repositioned by click-drag-drop |
| 2. Trace 1 marker with a single selected marker [9] repositioned by click-drag-drop | 4. Highlighted active trace. |

Figure 4-26. Marker Data Display Drag-Drop

4-14 Working with Limit Lines

Limit lines are a powerful tool to help compare a set of measured DUT data against specifications or expectations. Figure 4-27 shows basic menu navigation to reposition markers through the Marker Display Menu.

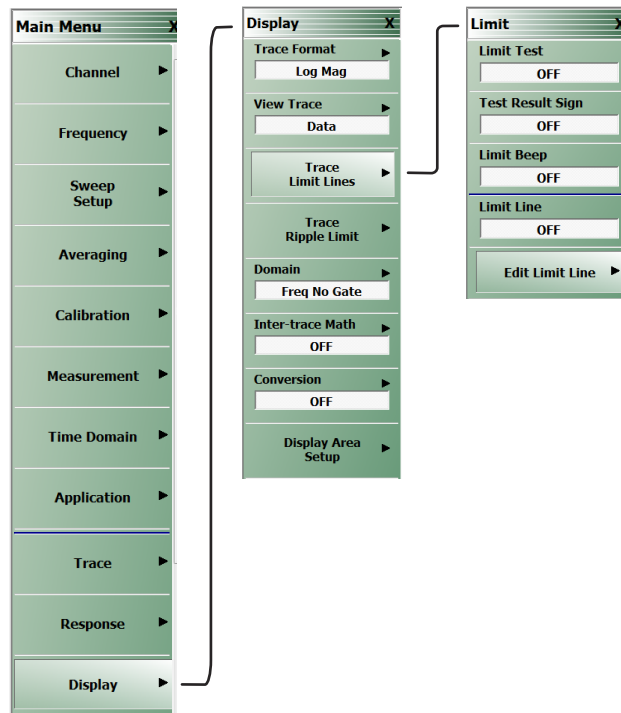

Figure 4-27. Display Trace Limit Line Menu

Limit lines

- Can be configured as settable maximum and/or minimum indicators for the value of displayed data on a per-trace basis.
- Can be rescaled automatically and maintains their correct value if the trace display is rescaled.
- Are settable in the basic units of each trace.
- Are limited to a total of 50 segments (upper and lower combined) per-trace.
- Are available only for ShockLine rectilinear and polar displays.
- Are not available for ShockLine Smith charts.
- For dual displays, such as the Log Mag And Phase display, the segment limit is 50 segments for the top display and 50 segments for the bottom display.

4-15 Working with Ripple Limit Lines

Limit lines are a powerful tool to help evaluate the ripple of a DUT against specifications or expectations. [Figure 4-28](#) shows basic menu navigation to reposition markers through the Marker Display Menu.

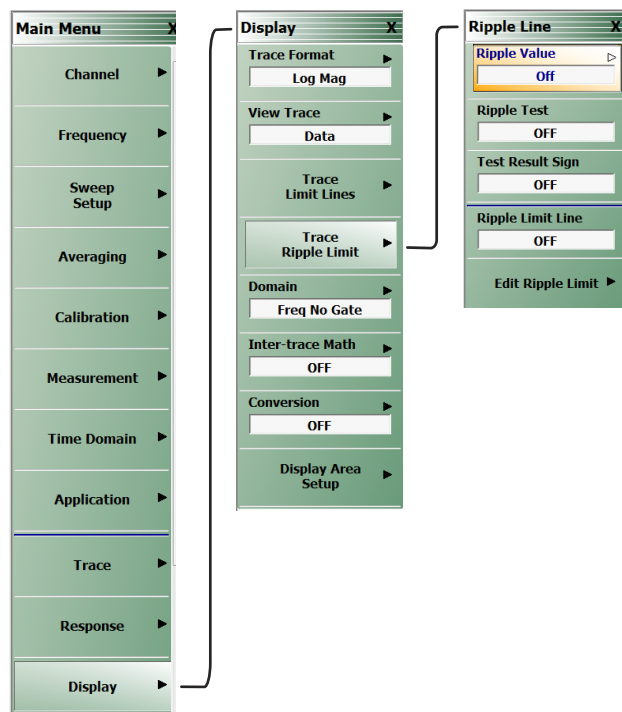

Figure 4-28. Display Trace Ripple Lines Menu

Ripple Limit lines

- Are settable tolerance indicators for the specified ripple value based on Absolute Value or Margin of displayed data on a per-trace basis.
- Are settable in the basic units of each trace.
- Are limited to a total of 50 segments (upper and lower combined) per-trace.
- Are available only for ShockLine rectilinear and polar displays.
- Are not available for ShockLine Smith charts.
- Can be used simultaneously with trace limit lines.
- Can be rescaled automatically and maintain their correct value if the trace display is rescaled.
- When used with trace limit lines and the Test Result sign functions, a logical OR is used as the result.

For dual displays, such as the Log Mag And Phase display, the segment limit is 50 segments for the top display and 50 segments for the bottom display.

Appendix A — Vector Network Analyzer Primer

A-1 Appendix Overview

This chapter describes the basic functions of a Vector Network Analyzer (VNA) and how it measures magnitude and phase characteristics of networks, amplifiers, attenuators, and antennas. Scattering parameters (S-parameters) are defined.

This section provides front panel operating and measurement application information and data. It includes discussions on the following topics:

- System description
- General discussion about network analyzers
- Basic measurements and how to make them
- Error correction
- General discussion on test sets

A-2 General Description

The ShockLine MS46322A/B Series Vector Network Analyzer (VNA) System measures the magnitude and phase characteristics of networks, amplifiers, attenuators, and antennas. It compares the incident signal that leaves the analyzer with either the signal that is transmitted through the test device or the signal that is reflected from its input. [Figure A-1](#) and [Figure A-2](#) illustrate the types of measurements that the MS46322A/B Series VNA can make.

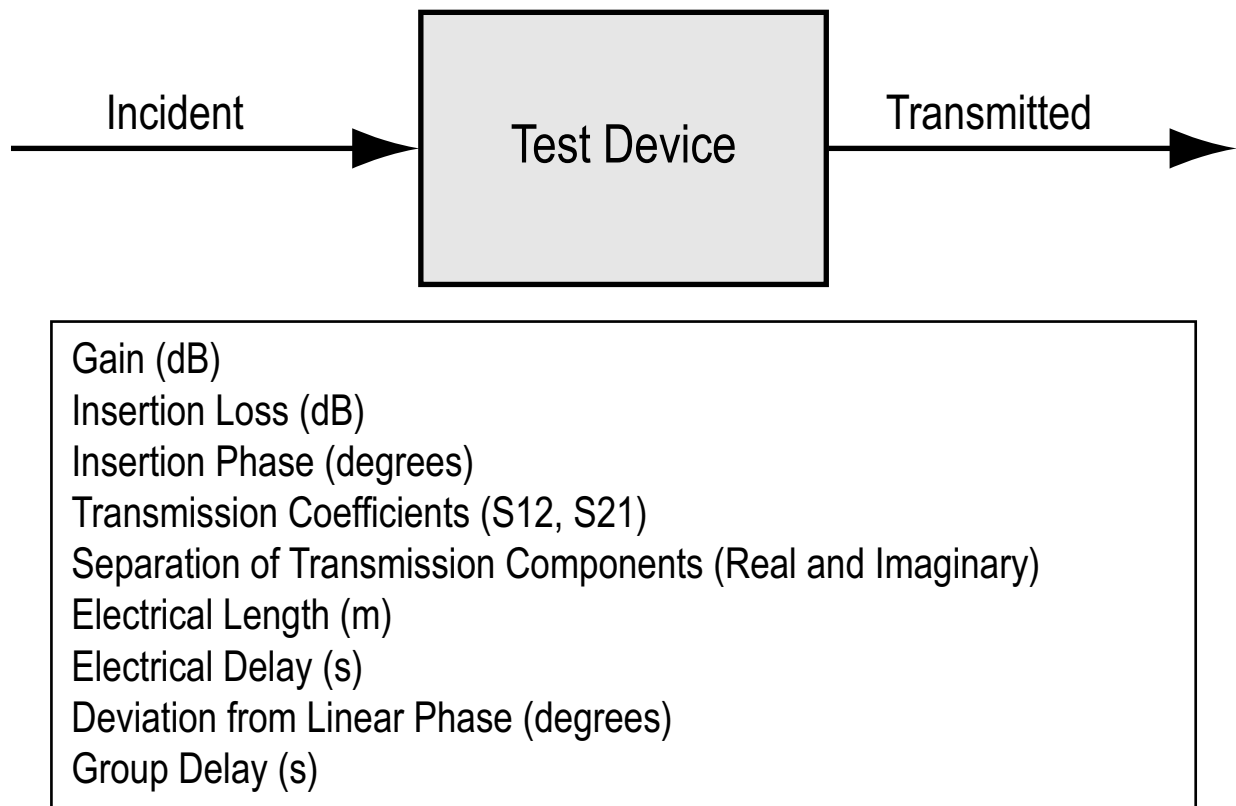

Figure A-1. Transmission Measurements

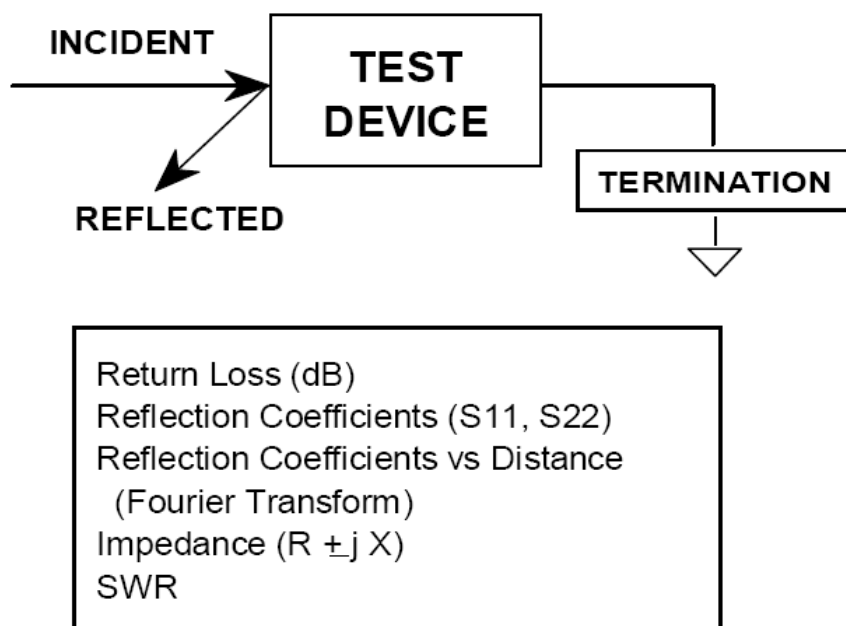

Figure A-2. Reflection Measurements

A-3 Instrument Description

The ShockLine MS46322A/B Series VNA is a self-contained, fully integrated measurement system that includes an optional time domain capability. The system hardware consists of the following:

- Analyzer
- Precision components required for calibration and performance verification

The ShockLine MS46322A/B Series VNA internal system modules perform the following functions:

Source Module

This module provides the stimulus to the device under test (DUT). The frequency range of the source and test set modules establish the frequency range of the system.

Test Set Module

The test set module routes the stimulus signal to the DUT and samples the reflected and transmitted signals. The type of connector used is important, as is the “Auto Reversing” feature. Auto Reversing means that it applies the stimulus signal in both the forward and reverse direction. The direction is reversed automatically. This saves you from having to reverse the test device physically to measure all four scattering parameters (S-parameters). Frequency conversion occurs in the test set module.

Analyzer Module

The analyzer module receives, and interprets the 3rd IF signal for phase and magnitude data. It then displays the results of this analysis on a large color display. This display can show all four S-parameters simultaneously. In addition to the installed display, you can also view the measurement results on an external color monitor.

A-4 Network Analyzers

We will begin this discussion with a subject familiar to most Anritsu customers: scalar network analysis. After showing comparisons, we will proceed to the fundamentals of network analyzer terminology and techniques. This discussion serves as an introduction to topics presented in greater detail later in this section. This discussion will touch on new concepts that include the following:

- Reference Delay
- S-parameters: what they are and how they are displayed
- Complex Impedance and Smith Charts

Scalar Analyzer Comparison

SCALAR NETWORK ANALYZERS

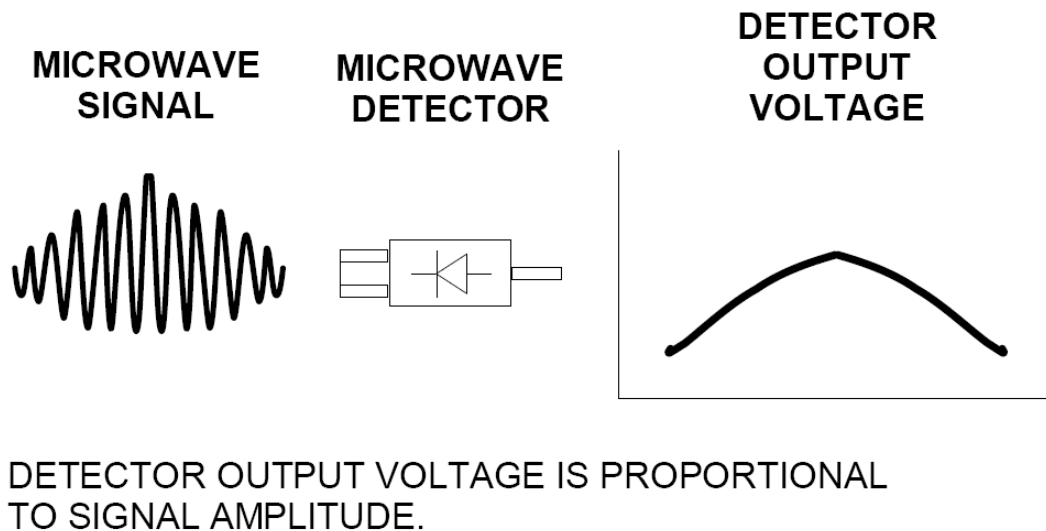

Figure A-3. Scalar Analyzer Detection

Network Analyzers do everything that scalar analyzers do except display absolute power, although absolute power can be displayed on a network analyzer through the use of a receiver calibration. In addition, they add the ability to measure the phase characteristics of microwave devices and allow greater dynamic range.

If all a Network Analyzer added was the capability for measuring phase characteristics, its usefulness would be limited. While phase measurements are important in themselves, it is the availability of this phase information that unlocks many new features for complex measurements. These features include Smith Charts, Time Domain, and Group Delay. Phase information also allows greater accuracy through *vector error correction* of the measured signal.

First, let us look at scalar network analyzers (SNAs). SNAs measure microwave signals by converting them to a DC voltage using a diode detector (Figure A-3). This DC voltage is proportional to the magnitude of the incoming signal. The detection process, however, ignores any information regarding the phase of the microwave signal.

In a vector network analyzer, access is needed to both the magnitude and phase of a microwave signal. There are several different ways to perform the measurement. The method Anritsu employs (called Harmonic Sampling or Harmonic Mixing) is to down-convert the signal to a lower intermediate frequency (IF). This signal can then be measured directly by a tuned receiver. The tuned receiver approach gives the system greater dynamic range. The system is also much less sensitive to interfering signals, including harmonics.

Vector Network Analyzer Basics

The vector network analyzer is a tuned receiver (Figure A-4). The microwave signal is down converted into the pass band of the IF. To measure the phase of this signal, we must have a reference to compare it with. If the phase of a signal is 90 degrees, it is 90 degrees different from the reference signal (Figure A-5). The network analyzer would read this as -90 degrees, since the test signal is delayed by 90 degrees with respect to the reference signal.

This phase reference can be obtained by splitting off some of the microwave signal before the measurement (Figure A-7).

A NETWORK ANALYZER IS A TUNED RECEIVER

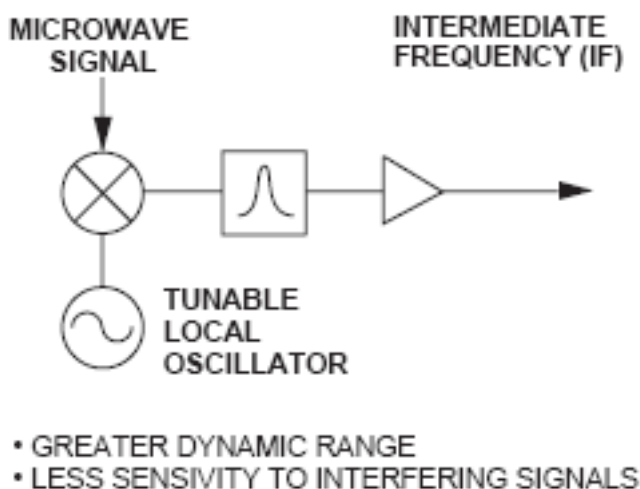

Figure A-4. Network Analyzer as a Tuned Receiver

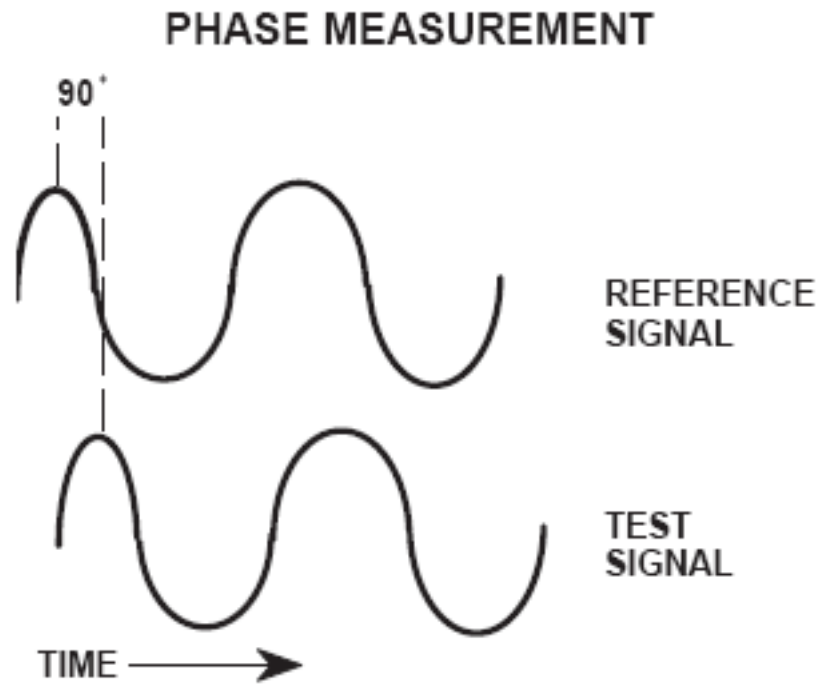

Figure A-5. Signals with a 90 Degree Phase Difference

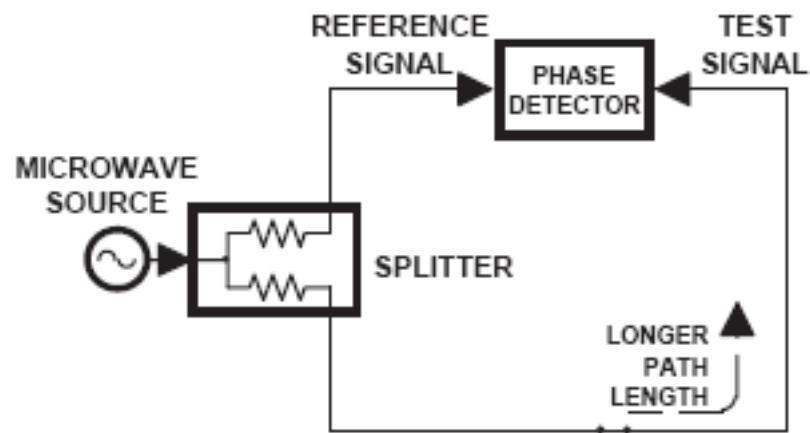

Figure A-6. Split Signal where a Length of Line Replaces the DUT

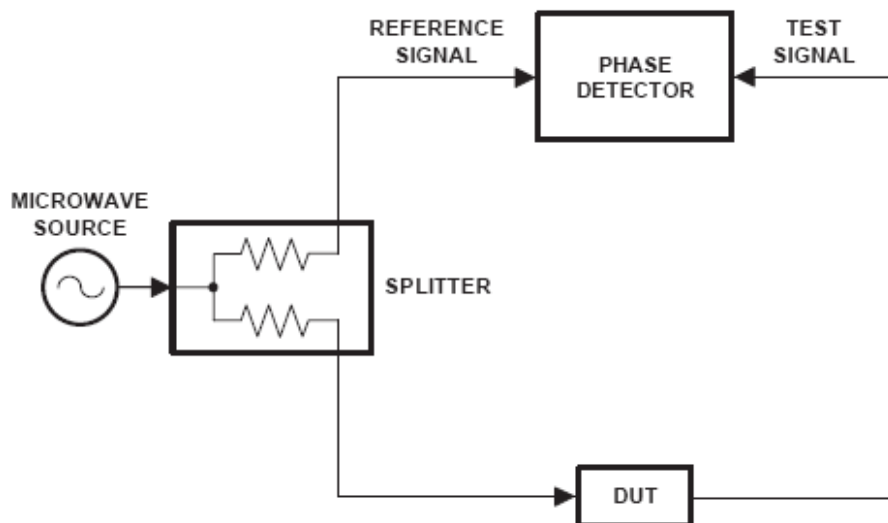

Figure A-7. Splitting the Microwave Signal

The phase of the microwave signal after it has passed through the device under test (DUT) is then compared with the reference signal. A network analyzer test set automatically samples the reference signal, so no external hardware is needed.

Let us consider for a moment that you remove the DUT and substitute a length of transmission line (Figure A-6). Note that the path length of the test signal is longer than that of the reference signal. Now let us see how this affects our measurement.

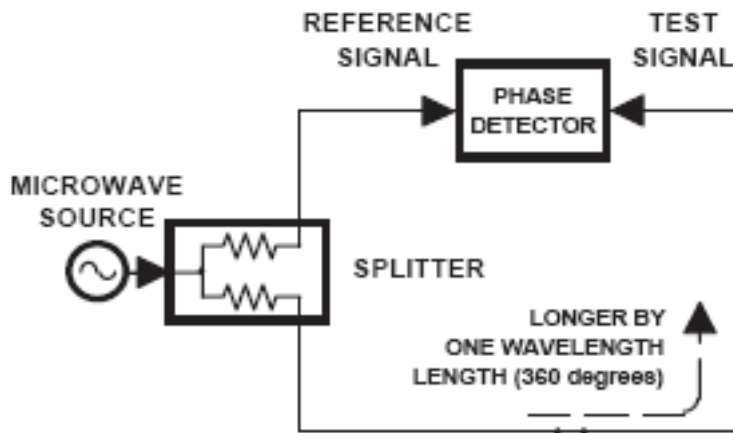

Figure A-8. Split Signal where Path Length is Different by Exactly One Wavelength

Assume that we are making a measurement at 1 GHz and that the difference in path-length between the two signals is exactly 1 wavelength. This means that test signal is lagging the reference signal by 360 degrees (Figure A-8). We cannot really tell the difference between one sine wave maxima and the next (they are all identical), so the network analyzer would measure a phase difference of 0 degrees.

Now consider that we make this same measurement at 1.1 GHz. The frequency is higher by 10 percent so therefore the wavelength is shorter by 10 percent. The test signal path length is now 0.1 wavelength longer than that of the reference signal (Figure A-9). This test signal is:

$$1.1 \times 360 = 396 \text{ degrees}$$

This is 36 degrees different from the phase measurement at 1 GHz. The network analyzer will display this phase difference as -36 degrees. The test signal at 1.1 GHz is delayed by 36 degrees more than the test signal at 1 GHz.

You can see that if the measurement frequency is 1.2 GHz, we will get a reading of -72 degrees, -108 degrees for 1.3 GHz, etc. (Figure A-10). There is an electrical delay between the reference and test signals. For this delay we will use the common industry term of reference delay.

You also may hear it called phase delay. In older network analyzers you had to equalize the length of the reference arm with that of the test arm to make an appropriate measurement of phase vs. frequency.

To measure phase on a DUT, we want to remove this phase-change-vs.-frequency due to changes in the electrical length. This will allow us to view the actual phase characteristics. These characteristics may be much smaller than the phase change due to electrical length difference.

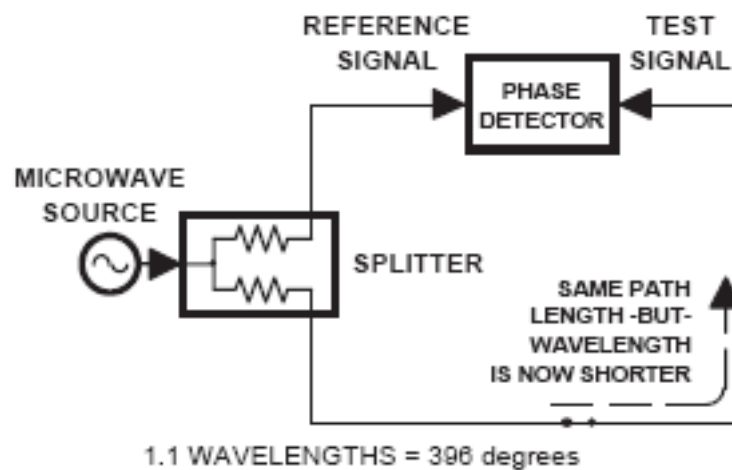

Figure A-9. Split Signal where Path Length is Longer than One Wavelength

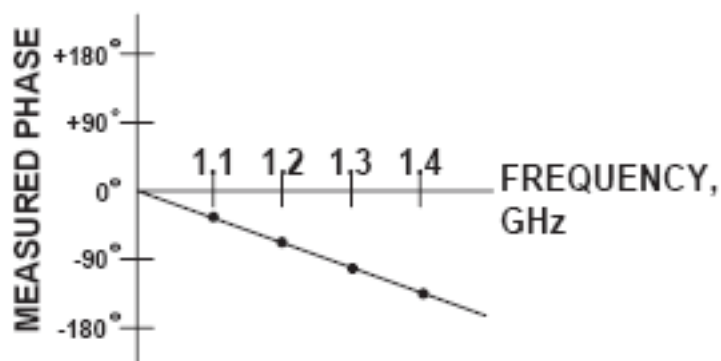

Figure A-10. Electrical Delay

There are two ways of accomplishing this. The most obvious way is to insert a length of line into the reference signal path to make both paths of equal length (Figure A-11). With perfect transmission lines and a perfect splitter, we would then measure a constant phase as we change the frequency. The problem using this approach is that we must change the line length with each measurement setup.

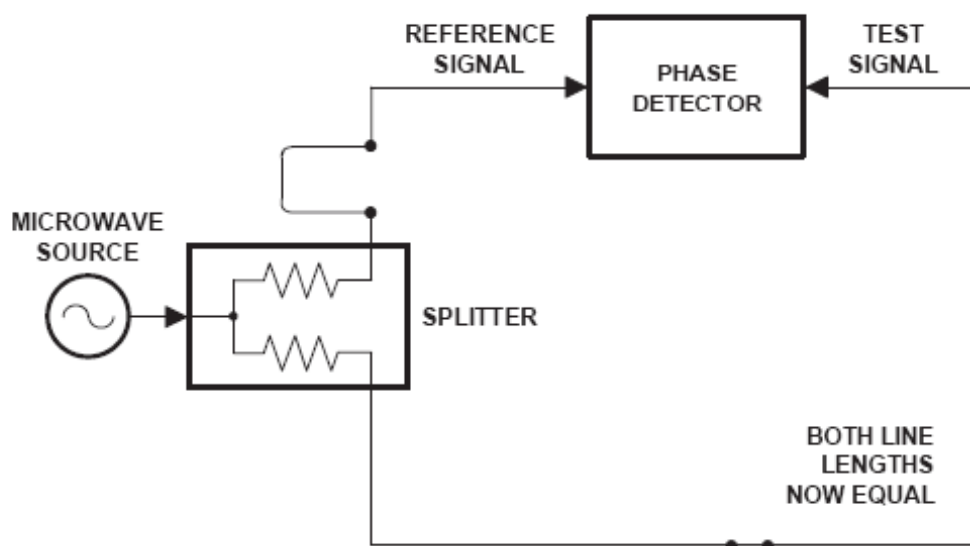

Figure A-11. Split Signal where Paths are of Equal Length

Another approach is to handle the path length difference in software. [Figure A-12](#) displays the phase-vs.-frequency of a device. This device has different effects on the output phase at different frequencies. Because of these differences, we do not have a perfectly linear phase response. We can easily detect this phase deviation by compensating for the linear phase. The size of the phase difference increases linearly with frequency so we can modify the phase display to eliminate this delay.

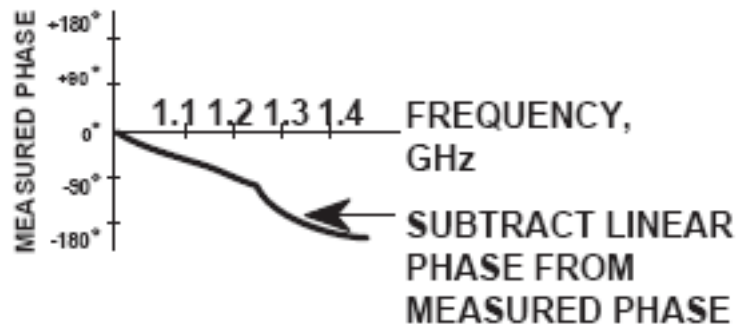

Figure A-12. Phase Difference Increases Linearly with Frequency

The ShockLine MS46322A/B Series VNA offers automatic reference delay compensation. [Figure A-13](#) shows the resultant measurement when we compensate path length. In a system application you can usually correct for length differences; however, the residual phase characteristics are critical.

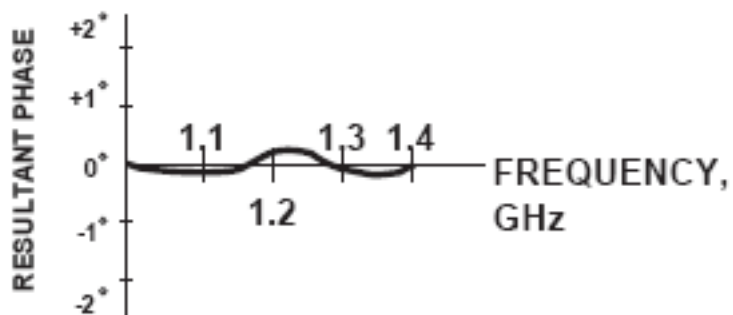

Figure A-13. Resultant Phase with Path Length

Now let us consider measuring the DUT. Consider a two port device; that is, a device with a connector on each end. What measurements would be of interest?

First, we could measure the reflection characteristics at either end with the other end terminated into 50-ohms. If we designate one end as the normal place for the input that gives a reference, we can then define the reflection characteristics from the reference end as forward reflection, and those from the other end as reverse reflection (Figure A-14).

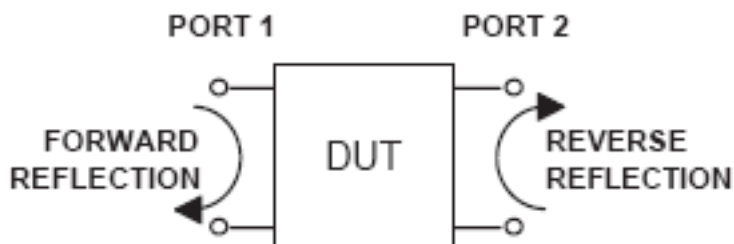

Figure A-14. Forward and Reverse Measurements

Second, we can measure the forward and reverse transmission characteristics. However, instead of saying “forward,” “reverse,” “reflection,” and “transmission” all the time, we use a shorthand. That is all that S-parameters are, a shorthand! The “S” stands for scattering. The second number is the device port that the signal is being injected into, while the first is the device port that the signal is leaving. S11, therefore, is the signal being injected into port 1 relative to the signal leaving port 1. The four scattering parameters (Figure A-15) are:

- S11: Forward Reflection
- S21: Forward Transmission
- S22: Reverse Reflection
- S12: Reverse Transmission

S-parameters can be displayed in many ways. An S-parameter consists of a magnitude and a phase. We can display the magnitude in dB, just like a scalar network analyzer. We often call this term log magnitude. We can display phase as “linear phase” (Figure A-16). As discussed earlier, we cannot tell the difference between one cycle and the next. Therefore, after going through 360 degrees, we are back to where we began. We can display the measurement from -180 to $+180$ degrees. The -180 to $+180$ degree approach is more common. It keeps the display discontinuity removed from the important 0 degree area used as the phase reference.

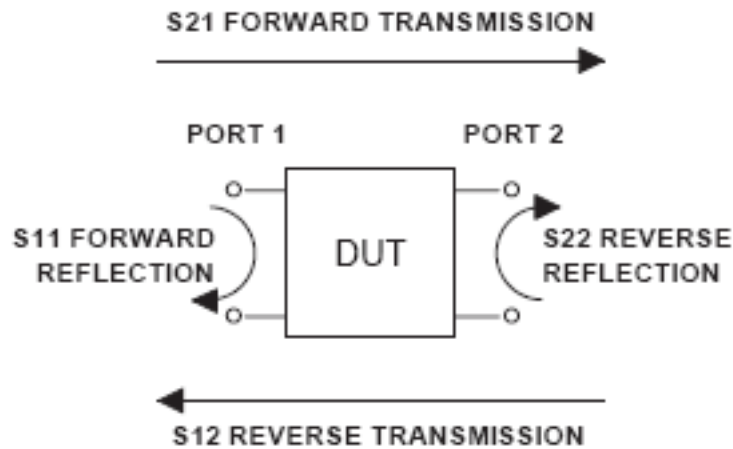

Figure A-15. S-Parameters



Figure A-16. Linear Phase with Frequency Waveform

There are several ways in which all the information can be displayed on one trace.

A-5 Polar Display

One method is a polar display (Figure A-17). The radial parameter (distance from the center) is magnitude. The rotation around the circle is phase. We sometimes use polar displays to view transmission measurements, especially on cascaded devices (devices in series). The transmission result is the addition of the phase and log magnitude (dB) information of each device's polar display.

Resistive and Reactive Terms

As we have discussed, the signal reflected from a DUT has both magnitude and phase. This is because the impedance of the device has both a resistive and a reactive term of the form $r+jx$. We refer to the r as the real or resistive term, while we call x the imaginary or reactive term. The j , which we sometimes denote as i , is an imaginary number.

It is the square root of -1 . If x is positive, the impedance is inductive; if x is negative, the impedance is capacitive.

The size and polarity of the reactive component x is important in impedance matching. The best match to a complex impedance is the complex conjugate. This complex-sounding term simply means an impedance with the same value of r and x , but with x of opposite polarity.

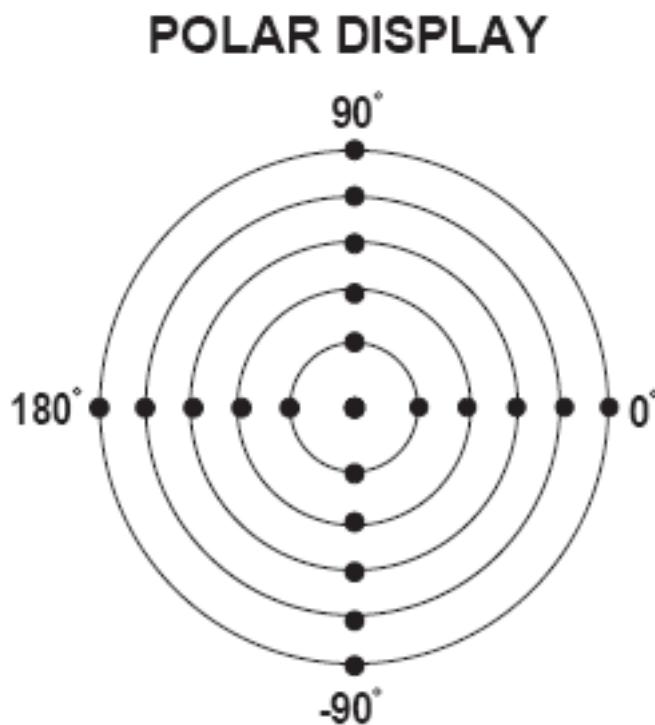

Figure A-17. Polar Display

A-6 Smith Chart

The complex conjugate is best analyzed using a Smith Chart (Figure A-18), which is a plot of r and x . To display all the information on a single S-parameter requires one or two traces, depending upon the format we want. A very common requirement is to view forward reflection on a Smith Chart (one trace) while observing forward transmission in Log Magnitude and Phase (two traces). Let us see how to accomplish this in the ShockLine MS46322A/B Series VNA.

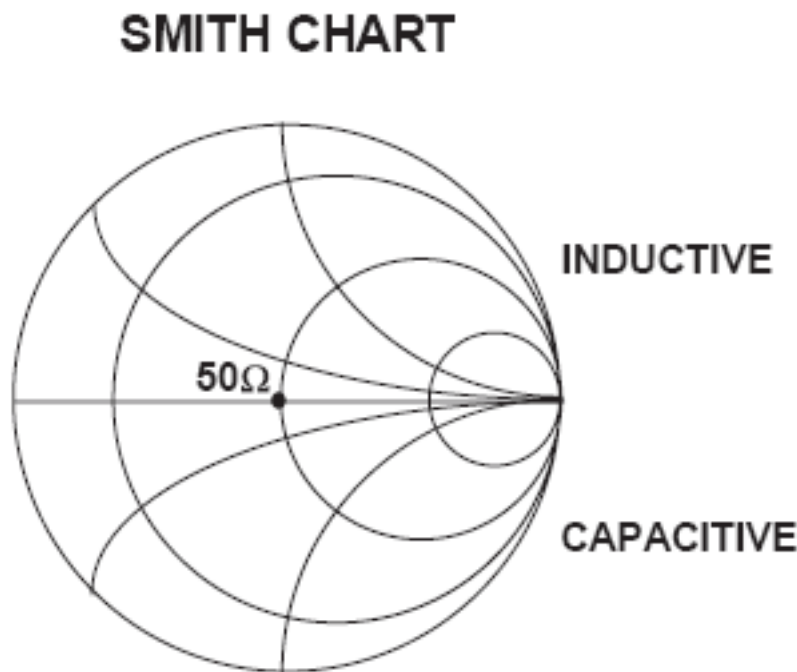

Figure A-18. Smith Chart

An important parameter we can measure when phase information is available is group delay. In linear devices, the phase change through the DUT is linear-with-frequency. Thus, doubling the frequency also doubles the phase change. An important measurement, especially for communications system users, is the rate of change-of-phase-vs.-frequency (group delay). If the rate of phase-change-vs.-frequency is not constant, the DUT is nonlinear. This nonlinearity can create distortion in communications systems.

Measurement Error Correction

Since we can measure microwave signals in both magnitude and phase, it is possible to correct for six major error terms:

- Source Test Port Match
- Load Test Port Match
- Directivity
- Isolation
- Transmission Frequency Response
- Reflection Frequency Response

We can correct for each of these six error terms in both the forward and reverse directions, hence the name 12-term error correction. Since 12-term error correction requires both forward and reverse measurement information, the test set must be *reversing*. “Reversing” means that it must be able to apply the measurement signal in either the forward or reverse direction.

MAGNITUDE AND PHASE OF EACH ERROR SIGNAL IS MEASURED



THEN THE RESULTANT VECTOR IS
APPLIED MATHEMATICALLY, HENCE
VECTOR ERROR CORRECTION

Figure A-19. Magnitude and Phase

To accomplish this error correction, we measure the magnitude and phase of each error signal (Figure A-19). Magnitude and phase information appear as a vector that is mathematically applied to the measurement signal. This process is termed *vector error correction*.

Appendix B — Security and Maintenance

B-1 Information Security

The MS46322B is a secure device and can be moved in and out of the secure facilities as there are no user accessible locations on the MS46322B.

Storage and Memory Overview

Considering secure environments, the internal memories of the ShockLine MS46322A/B Series VNA uses DRAM (Dynamic Random Access Memory) in its CPU board and Flash Memory in its DSP (Digital Signal Processing) board. The internal storage drive is a SATA Solid State Drive (SSD).

Note Only insert or remove the SSD when the VNA is completely powered down.
--

- **DRAM:** Information stored in DRAM and used by the ShockLine CPU is temporary; this data is lost when the ShockLine is powered off.
- **Flash Memory:** Flash Memory is used to save instrument factory calibrations and settings. No user application information is stored in Flash Memory and the memory space is not user-accessible. Since this memory space is not used by the user, nor by the instrument to store user application settings, it does not require cleansing after it has entered a secure location.
- **Solid State Drive:** The Solid State Drive (SSD) persistently stores configuration data and measurements including instrument saved setups, custom presets, last used setups, and similar information. Once the instrument enters a Secure Location, the SSD must not be removed from that location. For that purpose, the SSD is accessible from the rear panel, and can be removed by loosening a pair of screws and sliding it out. The VNA case chassis can then be transferred to another location and the SSD can be left in the secure location.
- **Enhancing Information Security:** For secure applications and locations, the removable solid-state drive (SSD) for the MS46322A and MS46322B can be easily and quickly removed from the instrument chassis and stored in a secure location. VNAs can be secured separately if the instrument chassis is used in a non-secure environment and can be exchanged with another SSD. When ordering replacement SSDs:
 - The MS46322A SSD external disk drive accessory kit is Anritsu part number 2000-1857-R. The 2000-1857-R SSD contains the latest versions of the operating system and software applications required to run the MS46322A which may not match the original versions of software shipped with the instrument.
 - The MS46322B SSD external disk drive accessory kit is Anritsu part number 2000-1858-R. The 2000-1858-R SSD contains the latest versions of the operating system and software applications required to run the MS46322B which may not match the original versions of software shipped with the instrument.

B-2 Maintaining Operating System Integrity

The Microsoft Windows 10 IoT operating system for the ShockLine MS46322A/B Series VNA is configured for optimum performance when the instrument leaves the factory. To maintain the system's operating integrity, follow proper Windows shutdown procedures and DO NOT modify the operating system configuration, the firewall settings, the system registry, the internal drive partitions, or the Anritsu user accounts.

Antivirus Protection

The ShockLine MS46322A/B Series VNA can be used with most common antivirus software, but stability is not guaranteed with all antivirus software. Anritsu recommends connecting the instrument only to a secure network. The user assumes the responsibility to provide virus protection because this is not supplied with the instrument. Contact your network administrator for information about your network security and antivirus protection policies.

Windows Updates

Not all Microsoft updates are compatible with the ShockLine MS46322A/B Series VNA and, if installed, may affect the performance of the instrument.

Caution

Changing some of the default Windows settings may cause a loss of instrument control or undesired instrument behavior. Changing the Windows Regional and Language Options settings may cause unstable menu operation. These settings must be maintained as English (United States) as is set at the factory by default.

The ability of the VNA to automatically receive and install updates has been turned off. Anritsu recommends not installing updates from Microsoft. Ensure that the Windows update feature of the operating system remains off. For procedures on how to safeguard the instrument from undesired conditions that could result from Windows updates, consult Anritsu customer service at <https://www.anritsu.com/en-US/contact-us>.

Operating system updates should only be installed from the Anritsu Website at: <https://www.anritsu.com/en-US/>.

B-3 Operating System Restore

The ShockLine VNA is shipped with an Anritsu Factory Restore Point disk. Additional restore points are created when the ShockLine application is updated, other user applications are installed, when new or updated hardware drivers are installed, or when restore points are created manually. Restore points are saved for a limited time, so the system should be restored as soon as problems are discovered.

Note	For detailed information about system restore and additional restore tasks, refer to the Windows Operating System Help and Support as detailed in the procedure below.
-------------	--

In the event that the ShockLine operating system or application becomes corrupt or inoperable, the instrument must be returned to a qualified service center for repair.

Caution	<p>Do not use a copy of Microsoft Windows 10 IoT to restore the ShockLine VNA internal drive. Using this to restore the VNA's operating system will remove the ShockLine VNA applications.</p> <p>Restoring the system software may adversely affect some user data or programs that are loaded onto the internal drive. The instrument operating system will be configured as it was on the selected restore date, including the original option configuration. Before starting the system restore procedure, back up all user data, applications, and ensure that the installation files of any additional software or instrument options are available for reinstallation.</p>
----------------	--

Procedure

The following procedure should be performed with a mouse attached to the instrument.

1. Close the ShockLine application and reveal the operating system desktop by clicking:
File | Exit
2. To access the Operating System Help and Support for additional information on System Restore, move the mouse pointer to the bottom of the desktop to reveal the Windows Task Bar and click:
Start | Help and Support
Search for topics on "System Restore."
3. Open System Restore by moving the mouse pointer to the bottom of the desktop to reveal the Windows Task Bar and clicking:
Start | Programs | Accessories | System Tools | System Restore
4. If you are prompted for an administrator password or confirmation, enter the password or provide confirmation.
5. Follow the on-screen instructions to restore your computer to an earlier restore point shown on the calendar. The most recent known good restore point should be used to restore the instrument operating system.
6. Do not interrupt the restoration process once it has been started.

B-4 Optional Rack Mount Installation

Instruments that are ordered from the factory with a rack mount option arrive with the rack mount hardware pre-installed. Alternatively, the rack mount option may be ordered at a later time and installed whenever required by the user. The general procedure to install the rack mount kit is described below:

1. Disconnect the line cord and any other attachments from the instrument.
2. Carefully place the instrument on a secure and stable work surface.
3. Using a Phillips screwdriver, remove the two front panel handles and the four feet at the rear of the instrument (see [Figure B-1](#)). Save the screws for later use.

Note

The rack mount kit includes screws with green heads specifically designed for mounting your Anritsu equipment. Screws with green heads have metric threads. If it becomes necessary to replace any of these screws, always use the exact replacement to avoid damage to the instrument. The Anritsu part numbers for the front panel handles metric-threaded screws are 3-905-2758 (long) and the metric-threaded screws for the rear panel feet are 3-905-2639P (short).

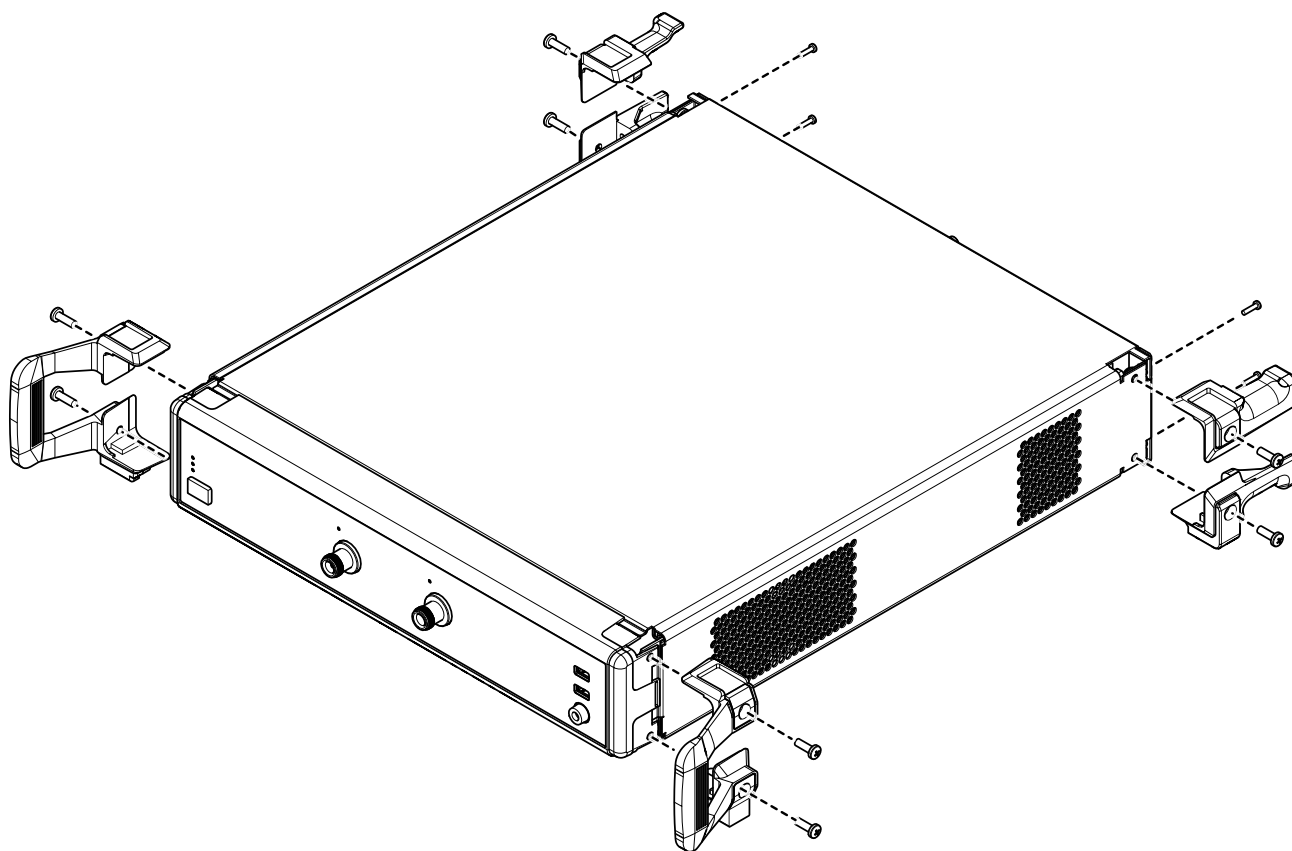

Figure B-1. Removing Instrument Handles and Feet for Rack Mount

Note

The rack installation figures are for generic instruments and may differ in general appearance.

4. Install the rack mount brackets onto the instrument sides using the green-headed M5 x 15 mm screws removed earlier (see [Figure B-2](#))
5. Install the four pan head M3 x 6 mm screws supplied with the rack mount bracket to the back panel. These screws replace the four M3 x 12 mm screws removed earlier.

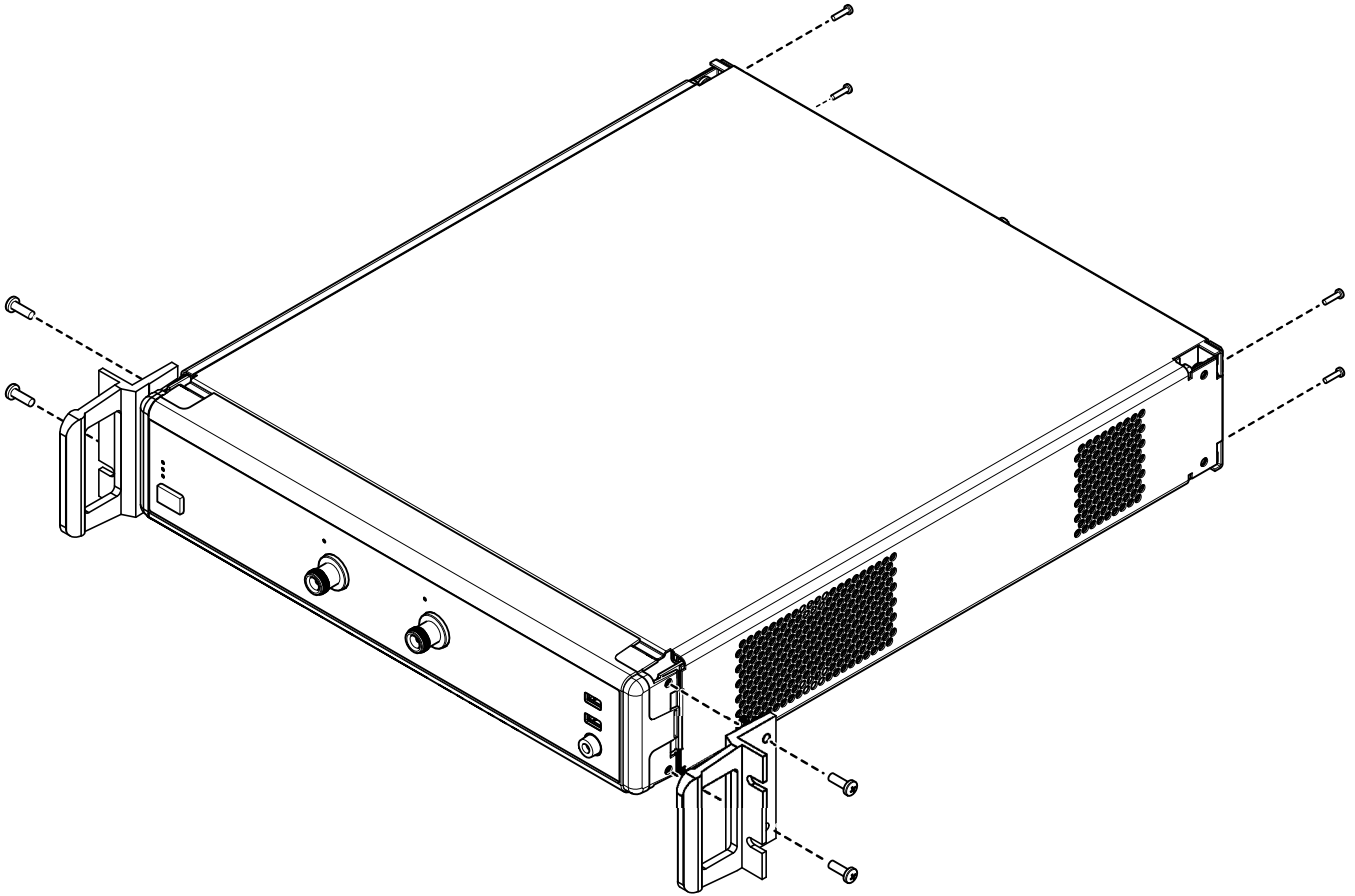

Figure B-2. Attaching Rack Mount Brackets to the Instrument

6. This completes the installation of the rack mount handles.

B-5 Hard Drive Removal and Installation

This MA46322A has one hard drive, and it may be easily removed for security purposes. Refer to [Figure B-3](#).

Removal Procedure

1. Following the instructions for system power-down in “[Power-On/Power-Off Procedures](#)” on page 3-3, power the instrument off, using the front panel switch. Wait until the power light goes off.

Note The switch is not directly a power switch but instead signals the internal computer to perform an orderly shutdown of the operating system.

2. Remove the power cord from the rear panel connector.
3. At the rear panel, undo the two straight-slot screws holding the drive carrier to the chassis.
4. Grasp drive carrier and pull so that its connector disengages and the drive tray slides out of the chassis.
5. Anritsu recommends you place the isolated drive into an anti-static bag for transport.

Installation Procedure

1. Align connector end of drive with rear panel and slide it into the chassis until it touches the internal matching connector. Gently push to settle the connector in. Do not force.
2. Gently tighten the drive mounting screws. Do not force.
3. Install the power cord in the rear panel connector.
4. To restart the instrument, press the front panel power switch.

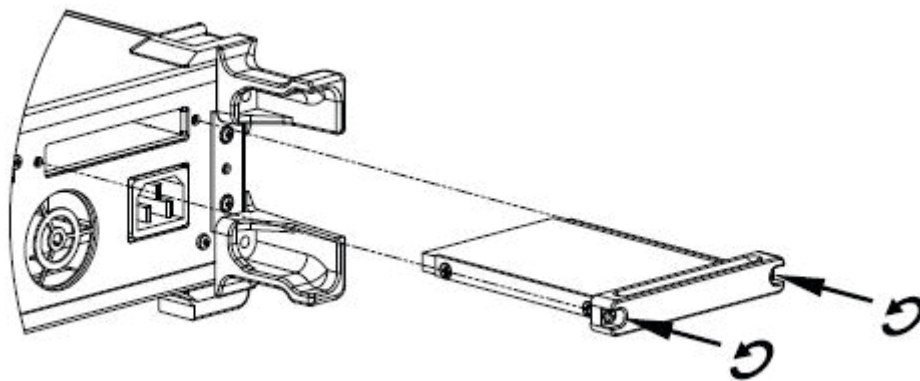

Figure B-3. Driver Position and Location

B-6 Preparation for Storage or Shipment

Use the following information for preparing the ShockLine MS46322A/B Series VNA for storage or shipment.

Preparation for Storage

Preparing the VNA for storage consists of cleaning the unit, packing it inside of the storage container with moisture-absorbing desiccant crystals, and storing the unit in a temperature-controlled environment that is maintained between $-40\text{ }^{\circ}\text{C}$ and $+75\text{ }^{\circ}\text{C}$.

Preparation for Shipment

To provide maximum protection against damage in transit, the VNA should be repackaged in the original shipping container. If this container is not available and the unit is being returned to Anritsu for repair, advise Anritsu Customer Service to inquire about obtaining a suitable container. In the event these options are not possible, instructions for packaging and shipment are given below:

Remove Attached Equipment and Connectors

1. Remove any user-supplied connectors or adapters. If installed, remove the rack mounting ears and related hardware.

Use a Suitable Container

2. Obtain a corrugated cardboard carton with at least 125 kg test strength. This carton should have inside dimensions of no less than 15 cm (6.0") larger than the instrument unit dimensions to allow for cushioning.

Dimensions

3. The instrument body dimensions are:
 - **Height:** 108 mm
 - **Width:** 484 mm
 - **Depth:** 590 mm

Protect the Instrument

4. Surround the unit with polyethylene sheeting to protect the finish. A sealed bag is recommended as a best practice.

Cushion the Instrument

5. Cushion the instrument on all sides by tightly packing dunnage or urethane foam between the carton and the unit. Provide at least 8 cm (3.0") of dunnage on all sides; best practices recommend completely filling the space between the carton and instrument with dunnage.

Seal the Container

6. Seal the carton by using either shipping tape or an industrial stapler.

Address the Container

7. If the instrument is being returned to Anritsu for service, mark the address of the appropriate Anritsu service center and your return address on the carton in one or more prominent locations.

Contact information for all worldwide Anritsu Service Centers is available on the web site at:

<http://www.anritsu.com/Contact.asp>

Appendix C — Troubleshooting

C-1 Introduction

This section provides troubleshooting tips when operating the MS46322A/B.

Tips include:

- [Section C-2 “Anritsu Hardware is Unavailable”](#)
- [Section C-3 “Driver Initialization Error”](#)
- [Section C-4 “Application Launch Failure”](#)
- [Section C-5 “EEPROM Does Not Match \(Firmware Update\)”](#)
- [Section C-6 “Updating EEPROM Unsuccessful \(Firmware Update Failed\)”](#)
- [Section C-7 “Updating Firmware Manually”](#)
- [Section C-8 “Printout Does Not Capture the Entire ShockLine Screen”](#)
- [Section C-9 “Running ShockLine as Non-administrator”](#)

C-2 Anritsu Hardware is Unavailable

ShockLine software and IVI Clients cannot run simultaneously on the same PC. If ShockLine software is running and an IVI client is being started, then the ShockLine GUI will be automatically stopped. But if an IVI client is running, the ShockLine GUI will not be able to start and the following error message will be displayed as shown in [Figure C-1](#). If this occurs, wait until the IVI client finishes and retry after to run ShockLine GUI.

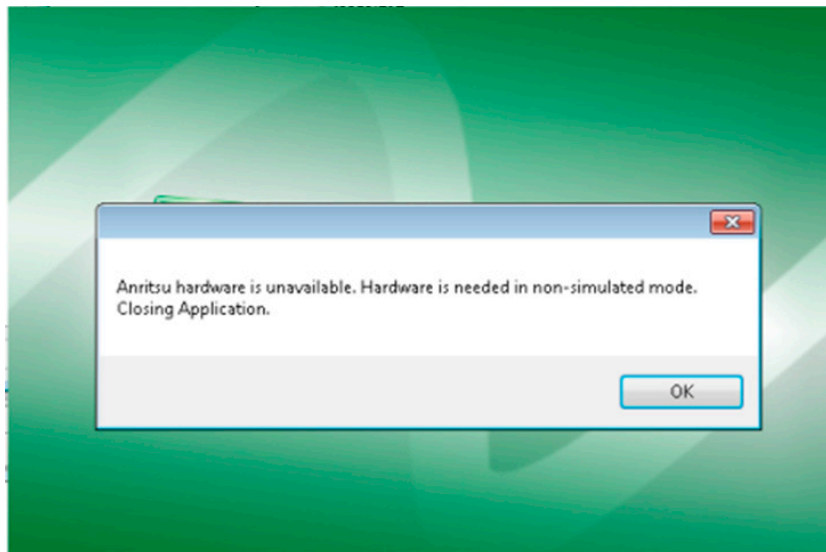
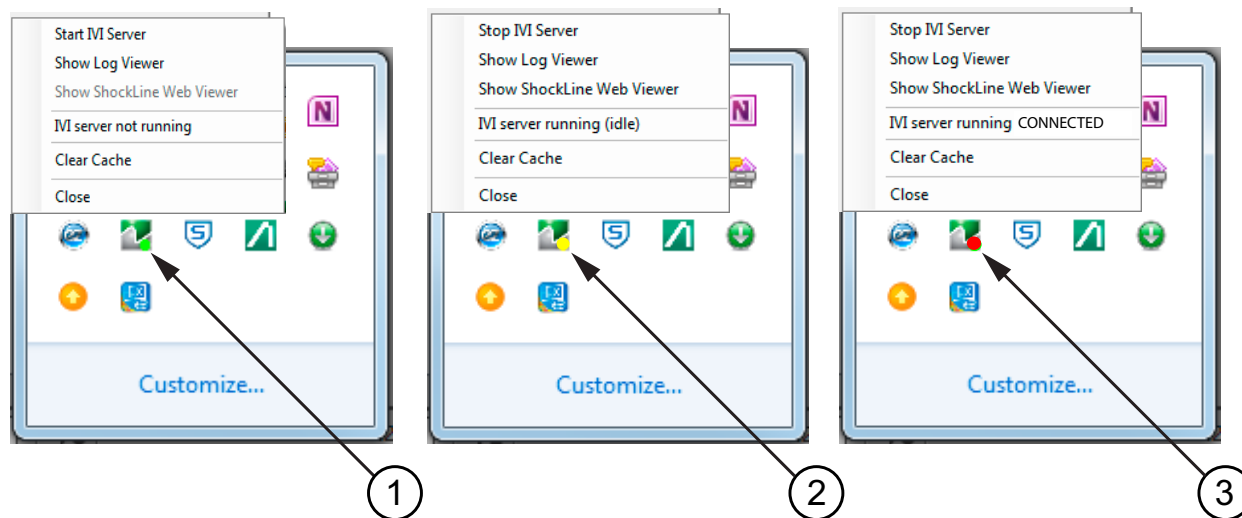

Figure C-1. Anritsu Hardware Is Unavailable

Or if the IVI client was not properly closed, then the IVI Server has to be manually restarted because the hardware was not released.

Restart IVI Server

The ShockLine Tray Daemon provides the Start IVI Server and Stop IVI Server user interface.



1. Green Indicator
2. Yellow Indicator
3. Red Indicator

Figure C-2. ShockLine Tray Daemon

Indicator Color Definitions

Green

When ShockLine Tray Daemon is green – the IVI Server is not running and that no IVI connections are available. Only ShockLine GUI can be used.

Yellow

When ShockLine Tray Daemon is yellow – the IVI Server is running. The IVI Clients or ShockLine GUI can be run.

Red

Note the tray menu provides two status states when Red.

- If the state is “CONNECTED” – currently an IVI Client is connected and the hardware is busy; therefore, ShockLine GUI could not be used.
- If the state is “WAITING” – waiting for an IVI Client, but the hardware is not busy; therefore, ShockLine GUI nor an IVI Client can be run.

C-3 Driver Initialization Error

If an error occurs when trying to initialize an IVI Client as in [Figure C-3](#), then the IVI Server has to be restarted as described in “[Anritsu Hardware is Unavailable](#)” on page C-1.

```
C:\Program Files\IVI Foundation\IVI\Drivers\ANUNA\CSHARP\Examples\Debug>IVI-CSHARP-EXAMPLE.exe
Error 1101 while initialising the driver!
```

Figure C-3. Driver Initialization Error

C-4 Application Launch Failure

In order to fix Application Launch Failure, perform the following.

1. Download the MVC++ 2015 package (if it’s a 322/52X instrument you will need x86)
 - <https://www.microsoft.com/download/confirmation.aspx?id=52685>
2. Install the package.
 - If it returns an error saying that the same package is already installed, you might have to uninstall the current version of MVC++ 2015 first.
3. Download the ShockLine VNA Software from the Download Library located at:
 - <https://www.anritsu.com/test-measurement/support/download>

C-5 EEPROM Does Not Match (Firmware Update)

Note Firmware updates only work properly if only one Anritsu ShockLine instrument is connected.

ShockLine software will poll the firmware version (EEPROM) on the MS46322A/B, and if the software has an updated firmware version it will ask the user if they would like to update the firmware on the VNA, as shown in [Figure C-4](#). Users are recommended to always update firmware to the latest revision. Users must be in administrator mode in order to program the firmware.

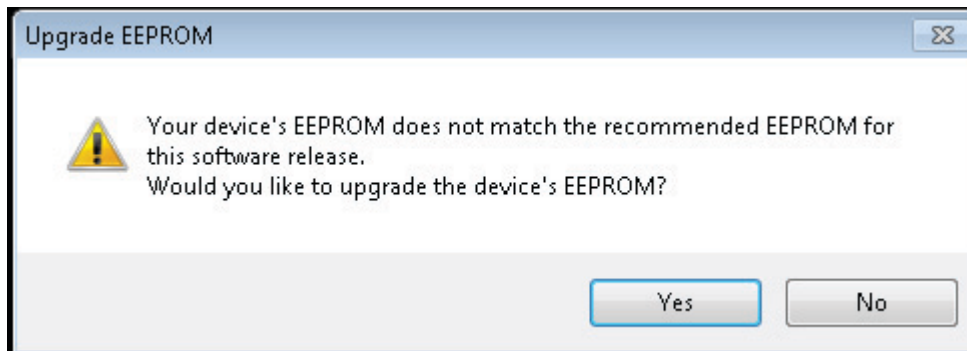

Figure C-4. EEPROM Does Not Match Warning Message

While the firmware update is proceeding, the message shown in [Figure C-5](#) will be displayed. Do not cycle the power or close the application while the firmware update is in process.

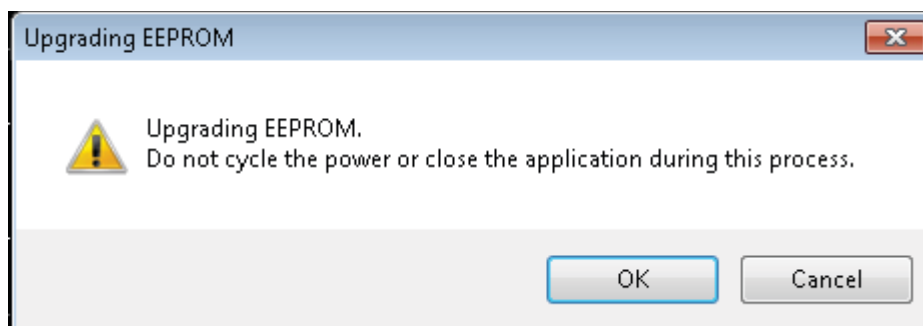

Figure C-5. Upgrading EEPROM (Firmware) Message

If the firmware update fails (see [Figure C-6](#)), proceed to the trouble-shooting tip: “[Updating EEPROM Unsuccessful \(Firmware Update Failed\)](#)”.

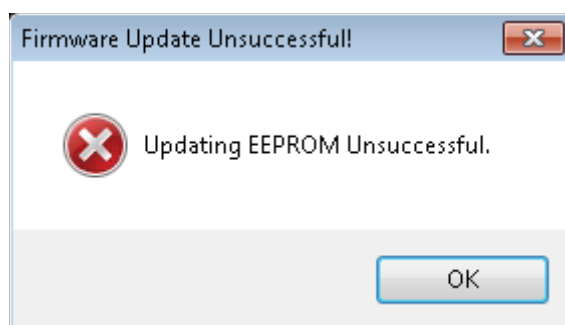

Figure C-6. Firmware Update Unsuccessful Message

C-6 Updating EEPROM Unsuccessful (Firmware Update Failed)

If the firmware update fails (see [Figure C-6](#)), but the trace display is active, either:

- Exit ShockLine, disconnect all USB devices but keyboard/mouse and Anritsu ShockLine instrument, then try again.

Note Firmware updates only work properly if only one Anritsu ShockLine instrument is connected.

- Make sure the user is running ShockLine as Administrator.

or

- Try to update the firmware manually (see the trouble-shooting tip “[Updating Firmware Manually](#)”).

Caution Updating the firmware manually could result in an inoperable instrument, requiring assistance from Anritsu Customer Service.

C-7 Updating Firmware Manually

If the firmware update fails repeatedly, perform the following steps:

1. Launch ShockLine as Administrator.
2. Click **No** if prompted to update firmware on startup.
3. Navigate to UTILITIES > System.
4. Click Update FPGA (if ShockLine is not run as Administrator, this button will be disabled).
5. Navigate to C:\Program Files (x86)\Anritsu Company\ShockLine\Application\Firmware in the Updating Firmware dialog.
6. Select the folder that matches the attached instrument.

Caution Attempting to load firmware for a non-matching instrument can render the instrument inoperable, and require a call to Anritsu Customer Service to get it working again.

7. Load the .fpga file from the selected folder.
8. Follow the prompts (may require closing the ShockLine application and/or rebooting).

Caution If done incorrectly, manually updating the firmware can result in an inoperable instrument that will require help from Anritsu to get working again. Contact Anritsu Customer Service at:
<https://www.anritsu.com/en-US/test-measurement/contact-us>

C-8 Printout Does Not Capture the Entire ShockLine Screen

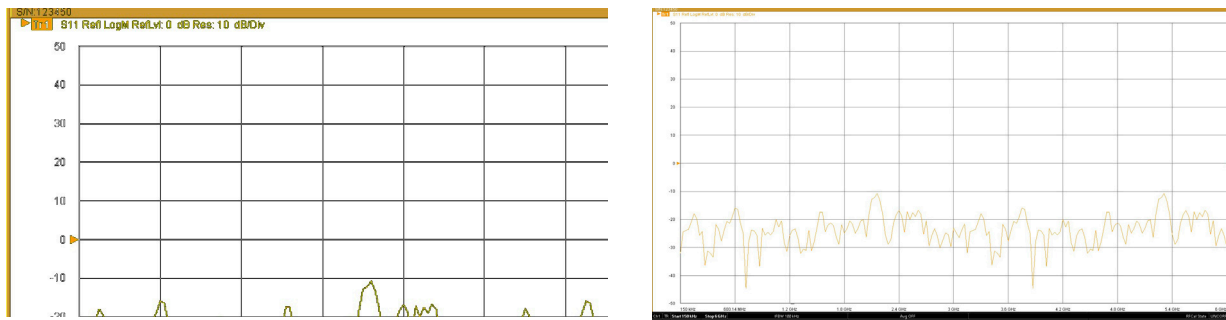

Scaling Too Large

Scaling 100%

Figure C-7. Windows System Display Settings: Scale and Layout

If the printout does not capture the entire screen, perform the following steps:

1. Set the Windows Settings > System > Display > Scale and Layout to 100%.

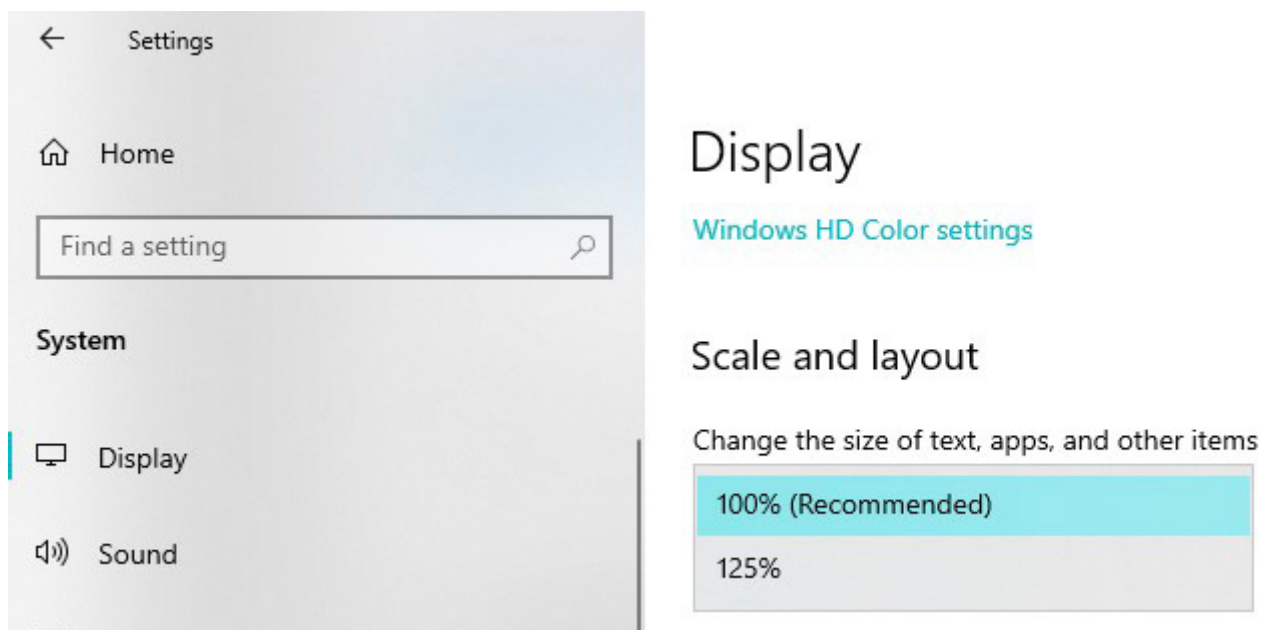

Figure C-8. Windows System Display Settings: Scale and Layout

C-9 Running ShockLine as Non-administrator

1. Right-click on the ShockLine Icon.
2. Select Properties from the drop-down menu.
3. Go to the Shortcut tab.
4. Click the Advanced button.
5. Un-click “Run as administrator”

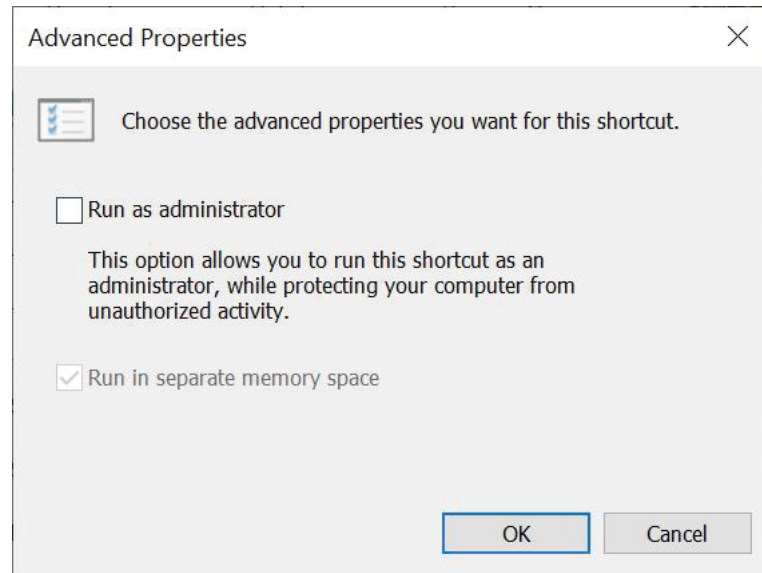

Figure C-9. Setting ShockLine to Run as Non-Administrator

Appendix D — Abbreviation Glossary

D-1 Appendix Overview

This glossary defines the abbreviations and terms that appear on the connectors, hard keys, menus, and buttons of the MS46322A/B Series VNA. In some cases, due to space limitations, multiple abbreviations are used for the same term or the same abbreviation is used with different punctuation.

D-2 Glossary

Abbreviation or Term	Meaning / Definition (1 of 14)
%	Percentage
#	Number
(1:2):3	One differential pair and one singleton. Trace and dialog labeling for Mixed-mode with one differential pair and one singleton. In this example, The DUT port differential is measured from 1 to 2 and 3 is the singleton.
(1:2):3:4	One differential pair and two singletons. Trace and dialog labeling for Mixed-mode with one differential pair and two singletons. In this example, the DUT port differential is measured from 1 to 2 while 3 and 4 are the singletons.
(4:1):(2:3)	Two differential pairs. Trace and dialog labeling for Mixed-mode with two differential pairs. In this example, the first port pair is measured from 4 to 1 and the second port pair is measured from 2 to 3.
(4:2):1	One differential pair and one singletons. Trace and dialog labeling for Mixed-mode with one differential pair and one singleton. The DUT port differential is measured from 4 to 2 and 1 is the singleton.
(4:2):1:3	One differential pair and two singletons. Trace and dialog labeling for Mixed-mode with one differential pair and two singletons. In this example, the DUT port differential is measured from 4 to 2 while 1 and 3 are the singletons.
(1:2):(3:4)	Two differential pairs. Trace and dialog labeling for Mixed-mode with two differential pairs. In this example, the first port pair is measured from 1 to 2 and the second port pair is measured from 3 to 4.
1P2PF	Abbreviation for one-path two-port calibration forward direction. Used in the SCPI command :SENSe{1-16}:CORRection:COLLect[:METHod]:1P2PF to simulate the calibration.
1P2PR	Abbreviation for one path two port calibration reverse direction. Used in the SCPI command :SENSe{1-16}:CORRection:COLLect[:METHod]:1P2PR to simulate the calibration.
A1 a1	Reference 1 or Reference a
A2 a2	Reference 2 or Reference b
Actv.	Active
Addr.	Address
ALC	Automatic Level Control

Abbreviation or Term	Meaning / Definition (2 of 14)
ALRM A-LRM™	Calibration menu. Advanced-Line-Reflect-Match calibration algorithm and method. A-LRM is a trademark of Anritsu Company.
Auto-Return Auto-return	User interface. After a button selection, the instrument automatically returns to previous menu where the user selection is usually displayed on a field button. Auto-return buttons are usually a member of a button selection group (“a radio button” group) described below.
Avg.	Average
B1 b1	S-Parameter. Test 1 or Test a
B2 b2	S-Parameter. Test 2 or Test b
Bal.	Balance
BB	Broadband
BeginningSwp	Beginning sweep
Button Selection Group	Popular name is “radio button” group. A group of two or more soft buttons where selection of one button de-selects all other button members of the group. Often combined with auto-return function (described above) where the interface automatically returns to previous menu after the button selection is made.
Button Buttons	Individual elements of the right-side user interface menus. Button come in a variety of types such as toggle buttons, or menu buttons. See also “Soft buttons.” Compare with “hard keys.”
C(P) C(S) C(S)-L(P) C(P)-L(S)	Abbreviation for LC circuit primitives. Capacitance (Parallel), Capacitance (S), Capacitance (Series)-Inductor (Parallel), and Capacitance (Parallel)-Inductor (Series).
CAL (.CAL) File	File type extension.
Cal. Eff. Pwr	Calculated effective power
Cal Cal.	Calibrate Calibration
Cals Cals.	Calibrations
CCKTFour	A four-node capacitance C circuit. Port assignments are defined in separate commands. Available if the instrument is in 4-Port VNA mode.
Charac.	Characterize Characterization
cm	Distance units abbreviation. Centimeter.
Cnt	Count
Coax	Coaxial cable
Coef.	Coefficient
Comm.	Communication
Compress	Compression
Config.	Configure Configuration

Abbreviation or Term	Meaning / Definition (3 of 14)
CPLS	Parallel capacitance with series inductance. Available if the instrument is in 2-Port VNA mode.
CSLP	Series capacitance with parallel inductance. For capacitance only, set L to zero. Available if the instrument is in 2-Port VNA mode.
CW	Continuous Wave
D1S0	<p>D One S Zero. In 4-Port VNAs, one differential pair and no singletons. Used in the MXP SETUP dialog box and the :CALCulate{1-16}:MXP SCPI commands.</p> <ul style="list-style-type: none"> • MAIN System SYSTEM Setup SETUP Misc. Setup MISC. SETUP MnP Files Setup MXP SETUP Dialog Box
D1S1	<p>D One S One. In 4-Port VNAs, one differential pair and one singleton. Used in the MXP SETUP dialog box and the :CALCulate{1-16}:MXP SCPI commands.</p> <ul style="list-style-type: none"> • MAIN System SYSTEM Setup SETUP Misc. Setup MISC. SETUP MnP Files Setup MXP SETUP Dialog Box
D1S2	<p>D One S Two. In 4-Port VNAs, one differential pair and two singletons. Used in the MXP SETUP dialog box and the :CALCulate{1-16}:MXP SCPI commands.</p> <ul style="list-style-type: none"> • MAIN System SYSTEM Setup SETUP Misc. Setup MISC. SETUP MnP Files Setup MXP SETUP Dialog Box
D2S0	<p>D Two S Zero. In 4-Port VNAs, two differential pairs and no singletons. Used in the MXP SETUP dialog box and the :CALCulate{1-16}:MXP SCPI commands.</p> <ul style="list-style-type: none"> • MAIN System SYSTEM Setup SETUP Misc. Setup MISC. SETUP MnP Files Setup MXP SETUP Dialog Box
DAC	Digital to Analog Converter
Data/Mem	Data value divided by the memory value.
Data+Mem	Data value plus the memory value.
DataMem	Data value times the memory value.
Data-Mem	Data value minus the memory value.
DataMemMath	Data and memory mathematical equations.
dB	Decibels
dB/Div	SCALE menu toolbar function. Decibels per trace display division.
DDS	Direct Digital Synthesis
De-embed De-Embed Deembed	De-embedding. Process where calibration parameters for a test fixture are removed from the calibrated instrument and connection cables.
Deg Degs	Degree Degrees
Degs/Div	SCALE menu toolbar function. Degrees per trace display division. For circular Polar or Smith Chart displays only.
Diff.	Differential
Div.	Division
DTF	Distance to fault
DUT	Device under test

Abbreviation or Term	Meaning / Definition (4 of 14)
E/DE EDE Embed Embedding	Embedding/De-Embedding. Process where known calibration parameters for a test fixture are added to the instrument calibration consisting of just the instrument and connection cables.
EMC	Electromagnetic Compatibility
Eqn	Equation
Ext.	External
Ext. Src. Addr.	External source address
Extrap	Extrapolation
Fctry	Factory
Field Toolbar	When some buttons are selected, the field toolbar that appears near the top of the screen display just below the icon toolbar. The toolbar provides user control to select the value of the required input such as a frequency, attenuation level, or device address. Some toolbar fields allow the selection of units; for example, frequency field toolbars allow selection of Hz, kHz, MHz, or GHz units. Some field toolbars appear at the bottom of the display area when editing table information such as for Segmented Sweep operations.
Flash drive	See USB Memory Device.
Freq-Base	Frequency-Based
Freq Freq.	Frequency
FreqIniTable.ini	File type.
FreqTable.mft	File type.
Full 2-port Full Two port	Calibration method. Also called “12 Term Calibration.”
FULL1	Abbreviation for full one port calibration. Used in the SCPI command :SENSe{1-16}:CORRection:COLLect[:METHod]:FULL1 to simulate the calibration.
FULL2	Abbreviation for full two port calibration. Used in the SCPI command :SENSe{1-16}:CORRection:COLLect[:METHod]:FULL2 to simulate the calibration.
FULLB	Abbreviation for full one port reflection calibration both ports. Used in the SCPI command :SENSe{1-16}:CORRection:COLLect[:METHod]:FULLB to simulate the calibration.
GHz	Gigahertz. 10E9 Hertz.
GPIB	IEEE-488.2 General Purpose Interface Bus. GPIB Command.
GUI	Graphical User Interface
HDD	Hard Disk Drive
Het.	Heterodyne
ID	Identification number
IEC	International Electrotechnical Commission
IEEE	Institute of Electrical and Electronics Engineers
IEEE-488.2	IEEE Specification 488.2 for General Purpose Interface Bus (GPIB)

Abbreviation or Term	Meaning / Definition (5 of 14)
IF	Intermediate Frequency
IFBW	Intermediate Frequency Bandwidth
Imag.	Imaginary
IMD	Intermodulation distortion
Imped.	Impedance
Imped. Transf.	Impedance transformation
Indep.	Independent
Inter.	Interface Interference
IntraTrace	Mathematical operations within the same trace display. As opposed to inter-trace operations.
IP	Internet Protocol
j	Imaginary number
jX	Reactance term in Ohms
K Connector™	Connector type. Compatible with SMA, WSM and 3.5 mm connectors, it has a rated frequency range from DC to 40 GHz. K Connector is a trademark of Anritsu Company.
kHz	Kilohertz. 10E3 Hertz.
km	Distance units abbreviation. Kilometer.
L(P) L(S) L(P)-C(S) L(S)-C(P)	Abbreviation for LC circuit primitives. Inductor (Parallel), Inductor (Series), Inductor (Series)-Capacitance (Parallel), and Inductor (Parallel) and Capacitance (Series).
Lang.	Language
LCD	Liquid Crystal Display
LCKTFour	A four-node inductance L circuit. Port assignments are defined in separate commands. Available if the instrument is in 4-Port VNA mode.
Lft	Left
Lin	Linear
LO	Local Oscillator
Log	Logarithmic
LogMag	Logarithmic Magnitude
LRL/LRM	Calibration method. Line-reflect-line calibration algorithm. Line-reflect-match calibration algorithm.
LSCP	Series inductance with parallel capacitance. For inductance only, set C to zero. Available if the instrument is in 2-Port VNA mode.
LSCS	Parallel inductance with series capacitance. Available if the instrument is in 2-Port VNA mode.
LVD	Low Voltage Directive
m	Distance unit abbreviation. Meter.
Mag Mag.	Magnitude
max Num	Maximum Number

Abbreviation or Term	Meaning / Definition (6 of 14)
Max max	Maximum
MB/s	Megabytes per second
Mb Mbit	Megabit. 1 megabit equals 10E6 bits or 1,000,000 bits.
MB Mbyte	Megabyte. In SI decimal units, 1 megabyte equals 1000E3 bytes or 1,000,000 bytes. In IEC binary units, a “mebibyte or Mi” equals 1024E3 bytes or 1,048,576 bytes, but is also commonly called a “megabyte.”
Mem Mem.	Memory
Memory stick	See USB Memory Device.
menu	Available menus in the top level menu-bar command interface.
Menu command	Individual commands listed on a drop-down menu from the top menu bar. For example, on the File menu, the first command is Recall.
MFT (.mft) Files	File type extension.
MG	Anritsu Measurement Guide
MHz	Megahertz. 10E6 Hertz. 1,000,000 Hertz
Micr.	Microporous Teflon dielectric type
Min Min.	Minimum
Misc.	Miscellaneous
Mkr # [OFF]	Marker number with the Reference Marker function toggled off and the marker also toggled off; for example, Mkr 1 [OFF] for Marker 1.
Mkr # [ON]	Marker number with the Reference Marker function toggled off and the marker toggled on; for example, Mkr 1 [ON] for Marker 1.
Mkr#-Ref [OFF]	Marker number with the Reference Marker function toggled on and the marker toggled off; for example, Mkr1-Ref [OFF] for Marker 1.
Mkr#-Ref [ON]	Marker number with the Reference Marker function toggled on and the marker also toggled on; for example, Mkr1-Ref [ON] for Marker 1.
Mkr Mkrs	Marker, Markers
mm	Units abbreviation. Millimeter.
MM	Anritsu Maintenance Manual
mmWave mm-Wave	Millimeter wavelength
Model#	Model Number
ms	Time units abbreviation. Millisecond.
MS46322A/B Series VNA	The function or feature refers to any VNA model in the series: MS46322A/B.

Abbreviation or Term	Meaning / Definition (7 of 14)
Navigation paths	<p>Navigation to a menu or dialog box of interest is entered using navigation notation where the pipe (“ ”) symbol is used to separate elements. The starting menu is usually the MAIN Menu. The general format is with menu and dialog boxes in ALL CAPS and buttons in Title Case; both use this distinctive Sans Serif Font in the general format: MAIN Button MENU ... Button DESTINATION MENU/DIALOG BOX</p> <p>For example, the navigation path to the REFERENCE PLANE menu is: MAIN Measurement MEASUREMENT Reference Plane REFERENCE PLANE</p>
NIST	National Institute of Standards and Technology.
ns	Time units abbreviation. Nanosecond.
Ntwk Ntwk.	Network
Ohms/Div	SCALE menu toolbar function. Ohms (Ω) per trace display division.
OM	Anritsu Operations Manual
Op.	Operand Operation Operations
Out.	Output
P2P	Pulse-to-Pulse
Param.	Parameter Parameters
PDF	Proprietary Portable Document Format from Adobe Corporation.
PG	Pulse Generator
PIP	Point-in-Pulse
PM	Anritsu Programming Manual
Prev Prev.	Previous
PRF	Pulse Repetition Frequency
PRI	Pulse Repetition Interval
Profile	Pulse Profile
ps	Time units abbreviation. Picosecond.
Pwr Pwr.	Power
R	Resistance
R(P), R(S)	Parallel Resistance, Series Resistance
R-Circuit	Resistive element of an L-C circuit
RCKTFour	A four-node resistive R circuit. Port assignments are defined in separate commands. Available if the instrument is in 4-Port VNA mode.
Rcvr Rcvr.	Receiver

Abbreviation or Term	Meaning / Definition (8 of 14)
Rect.	Reactance Rectangle Rectangular
Ref.Mkr	Reference Marker
Ref Ref.	Reference
RESP1	Abbreviation for one-port response calibration. Used in the SCPI command <code>:SENSe{1-16}:CORRection:COLLect[:METHod]:RESP1</code> to simulate the calibration.
RESPB	Abbreviation for one-port response calibration both ports. Used in the SCPI command <code>:SENSe{1-16}:CORRection:COLLect[:METHod]:RESPB</code> to simulate the calibration.
RF	Radio Frequency
RP	Resistive parallel network. Available if the instrument is in 2-Port VNA mode.
RS	Resistive series network. Available if the instrument is in 2-Port VNA mode.
Rt	Right
s	Time units abbreviation. Second.
S11	S-Parameter. Used in text for S-parameter measurement of input reflection coefficient. In text written as "S11". Mathematical version uses subscripts as S_{11} . Available in 2-Port and 4-Port VNAs.
S12	S-Parameter. Used in text for S-parameter measurement of reverse transmission coefficient. Mathematical version uses subscripts as S_{12} . Available in 2-Port and 4-Port VNAs.
S13	S-Parameter. Used in test for S-parameter measurement. Mathematical version used subscripts as S_{13} . Available only in 4-Port VNAs.
S14	S-Parameter. Used in test for S-parameter measurement. Mathematical version used subscripts as S_{14} . Available only in 4-Port VNAs.
S21	S-Parameter. Used in text for S-parameter measurement of forward transmission coefficient. Mathematical version uses subscripts as S_{21} . Available in 2-Port and 4-Port VNAs.
S22	S-Parameter. Used in text for S-parameter measurement of output reflection coefficient. Mathematical version uses subscripts as S_{22} . Available in 2-Port and 4-Port VNAs.
S23	S-Parameter. Used in test for S-parameter measurement. Mathematical version used subscripts as S_{23} . Available only in 4-Port VNAs.
S24	S-Parameter. Used in test for S-parameter measurement. Mathematical version used subscripts as S_{23} . Available only in 4-Port VNAs.

Abbreviation or Term	Meaning / Definition (9 of 14)
s2p	File extension. Abbreviation for S-parameter 2-Port configuration file. The general type of file extension is referred to an “.snp” file where the “n” refers to the number of ports, such as “.s1p” for an S-parameter 1-Port configuration file.
S2Pfile	Allows an S2P calibration file to be used. Available if the instrument is in 2-Port VNA mode.
S31	S-Parameter. Used in test for S-parameter measurement. Mathematical version used subscripts as S_{31} . Available only in 4-Port VNAs.
S32	S-Parameter. Used in test for S-parameter measurement. Mathematical version used subscripts as S_{32} . Available only in 4-Port VNAs.
S33	S-Parameter. Used in test for S-parameter measurement. Mathematical version used subscripts as S_{33} . Available only in 4-Port VNAs.
S34	S-Parameter. Used in test for S-parameter measurement. Mathematical version used subscripts as S_{34} . Available only in 4-Port VNAs.
S41	S-Parameter. Used in test for S-parameter measurement. Mathematical version used subscripts as S_{41} . Available only in 4-Port VNAs.
S42	S-Parameter. Used in test for S-parameter measurement. Mathematical version used subscripts as S_{42} . Available only in 4-Port VNAs.
S43	S-Parameter. Used in test for S-parameter measurement. Mathematical version used subscripts as S_{43} . Available only in 4-Port VNAs.
S44	S-Parameter. Used in test for S-parameter measurement. Mathematical version used subscripts as S_{44} . Available only in 4-Port VNAs.
S4Pfile	Allows an S4P calibration file to be used. Available if the instrument is in 4-Port VNA mode.
SC1C1	Two differential pairs. Trace labeling for Mixed-mode with two differential pairs. S-parameter for common-mode reception at Pair 1 and common-mode drive at Pair 1.
SC1C2	Two differential pairs. Trace labeling for Mixed-mode with two differential pairs. S-parameter for common-mode reception at Pair 1 and common-mode drive at Pair 2.
SC1D1	Two differential pairs. Trace labeling for Mixed-mode with two differential pairs. S-parameter for common-mode reception at Pair 1 and differential drive at Pair 1.
SC1D2	Two differential pairs. Trace labeling for Mixed-mode with two differential pairs. S-parameter for common-mode reception at Pair 1 and differential drive at Pair 2.
SC2C1	Two differential pairs. Trace labeling for Mixed-mode with two differential pairs. S-parameter for common-mode reception at Pair 2 and common-mode drive at Pair 1.

Abbreviation or Term	Meaning / Definition (10 of 14)
SC2C2	Two differential pairs. Trace labeling for Mixed-mode with two differential pairs. S-parameter for common-mode reception at Pair 2 and common-mode drive at Pair 2.
SC2D1	Two differential pairs. Trace labeling for Mixed-mode with two differential pairs. S-parameter for common-mode reception at Pair 2 and differential drive at Pair 1.
SC2D2	Two differential pairs. Trace labeling for Mixed-mode with two differential pairs. S-parameter for common-mode reception at Pair 2 and differential drive at Pair 2.
SCC	<p>One differential pair and one singleton. Trace labeling for Mixed-mode with common-mode reception at Pair 1 and common-mode drive at Pair 1. S-Parameter for common-mode reception at Pair 1 and common-mode drive at Pair 1.</p> <p>One differential pair and two singletons. Trace labeling for Mixed-mode for Pair 1 common-mode reception and Pair 1 drive. S-Parameter for common-mode reception at Pair 1 and common-mode drive at Pair 1.</p> <p>Trace labeling for Mixed-mode with common-mode reception at Pair 1 and common-mode drive at Pair 2. S-Parameter for common-mode reception at Pair 1 and common-mode drive at Pair 1.</p>
SCD	<p>One differential pair and one singleton. Trace labeling for Mixed-mode for Pair 1 reception and Pair 1 drive. S-Parameter for common-mode reception at Pair 1 and differential drive at Pair 1.</p> <p>One differential pair and two singletons. Trace labeling for Mixed-mode with common-mode reception at Pair 1 and differential drive at Pair 2. S-Parameter for common-mode reception at Pair 1 and differential drive at Pair 1.</p>
SCX	<p>One differential pair and one singleton. Trace labeling for Mixed-mode with Pair 1 common-mode reception and singleton drive. S-Parameter for common-mode reception at Pair 1 and singleton drive.</p> <p>One differential pair and two singletons. Trace labeling for Mixed-mode with common-mode reception at Pair 1 and drive at first singleton. S-Parameter for common-mode reception at Pair 1 and first singleton drive.</p>
SCY	One differential pair and two singletons. Trace labeling for Mixed-mode with common-mode at Pair 1 and drive at second singleton. S-Parameter for common-mode reception at Pair 1 and second singleton drive.
SD1C1	Two differential pairs. Trace labeling for Mixed-mode with two differential pairs. S-parameter for differential reception at Pair 1 and common-mode drive at Pair 2.
SD1C2	Two differential pairs. Trace labeling for Mixed-mode with two differential pairs. S-parameter for differential reception at Pair 1 and common-mode drive at Pair 2.
SD1D1	Two differential pairs. Trace labeling for Mixed-mode with two differential pairs. S-parameter for differential reception at Pair 1 and differential drive at Pair 2.

Abbreviation or Term	Meaning / Definition (11 of 14)
SD1D2	Two differential pairs. Trace labeling for Mixed-mode with two differential pairs. S-parameter for differential reception at Pair 1 and differential drive at Pair 2.
SD2C1	Two differential pairs. Trace labeling for Mixed-mode with two differential pairs. S-parameter for differential reception at Pair 2 and common-mode drive at Pair 1.
SD2C2	Two differential pairs. Trace labeling for Mixed-mode with two differential pairs. S-parameter for differential reception at Pair 2 and common-mode drive at Pair 2.
SD2D1	Two differential pairs. Trace labeling for Mixed-mode with two differential pairs. S-parameter for differential reception at Pair 2 and differential drive at Pair 1.
SD2D2	Two differential pairs. Trace labeling for Mixed-mode with two differential pairs. S-parameter for differential reception at Pair 2 and differential drive at Pair 2.
SDC	<p>One differential pair and one singleton. Trace labeling for Mixed-mode for Pair 1 reception and Pair 1 drive. S-Parameter for differential reception at Pair 1 and common-mode drive at the port pair.</p> <p>One differential pair and two singletons. Trace labeling for Mixed-mode with differential reception at Pair 1 and common-mode drive at Pair 1. S-Parameter for differential reception and common-mode drive at Pair 1.</p>
SDD	<p>One differential pair and one singleton. Trace labeling for Mixed-mode for Pair 1 reception and Pair 1 drive. S-Parameter for differential reception and differential drive.</p> <p>One differential pair and two singletons. Trace labeling for Mixed-mode with differential reception at Pair 1 and differential drive at Pair 1. S-Parameter for differential reception and differential drive at Pair 1.</p>
SDX	<p>One differential pair and one singleton. Trace labeling for Mixed-mode for Pair 1 reception and singleton drive. S-Parameter for differential reception at Pair 1 and singleton drive.</p> <p>One differential pair and two singletons. Trace labeling for Mixed-mode with differential reception at Pair 1 and drive at first singleton. S-Parameter for differential reception at Pair 1 and first singleton drive.</p>
SDY	One differential pair and two singletons. Trace labeling for Mixed-mode with differential reception at Pair 1 and drive at second singleton. S-Parameter for differential reception at Pair 1 and second singleton drive.
Seg.	Segment Segmented
SerNum	Serial Number
Set.	Settings
SI	International System of Units
Single Offset	Calibration method

Abbreviation or Term	Meaning / Definition (12 of 14)
Soft buttons	Buttons that appear in the right side menu interface on the MS46322A/B Series VNA screen. In text, the name of the menu is formatted with a distinctive font in capitals, such as the FREQUENCY menu. Soft buttons on each menu, such as the Select Port toggle button are formatted in the same font with initial capitals.
SOLT/SOLR	Calibration methods. Short-open-load-thru or short-open-load-reciprocal calibration algorithm.
Sparam	S-Parameters or scattering parameters
S-Parameters s-parameters	Scattering parameters.
Src Src.	Source
SRPRP SRR SXR SRX SXX	General button format for mixed mode settings. In 4-port VNA mixed mode settings, this is the name format of the selectable button names. For buttons with five letters, “S” indicates a mixed mode S-Parameter, “R” is the selected response type of either “D” for differential or “C” for common mode, and “P” is the Port number between 1 and 4. For buttons with three letters, “S” indicates a mixed-mode S-Parameter, “R” is the selected response type of either “D” for differential or “C” for common mode, and “X” is the singleton drive.
SSD	Solid State Drive
SSLT/SSLR	Calibration methods. Short-short-load-thru or short-short-load-reciprocal calibration algorithm
SSST/SSSR	Calibration methods. Short-short-short-thru or short-short-short-reciprocal calibration algorithm. Also called “Triple Offset Short”.
Swp	Sweep
SWR	Standing Wave Ratio
SXC	One differential pair and one singleton. Trace labeling for Mixed-mode with first singleton reception and common-mode drive at Pair 1. S-Parameter for first singleton reception and common-mode drive at Pair 1. One differential pair and two singletons. Trace labeling for Mixed-mode with singleton reception and differential drive. S-Parameter for singleton reception and common-mode drive at Pair 1.
SXD	One differential pair and one singleton. Trace labeling for Mixed-mode with singleton reception and Pair 1 drive. S-Parameter for singleton reception and differential drive at Pair 1. One differential pair and two singletons. Trace labeling for Mixed-mode with first singleton reception and differential drive at Pair 1. S-Parameter for first singleton reception and differential drive at Pair 1.
SXX	One differential pair and one singleton. Trace labeling for Mixed-mode with singleton reception and singleton drive. S-Parameter for singleton reception and singleton drive. One differential pair and two singletons. Trace labeling for Mixed-mode with first singleton reception and first singleton drive. S-Parameter for first singleton reception and first singleton drive.

Abbreviation or Term	Meaning / Definition (13 of 14)
SXY	One differential pair and two singletons. Trace labeling for Mixed-mode with first singleton reception and first singleton drive. S-Parameter for first singleton reception and second singleton drive.
SYC	One differential pair and two singletons. Trace labeling for Mixed-mode with second singleton reception and common-mode drive at Pair 1. S-Parameter for second singleton reception and common-mode drive at Pair 1.
SYD	One differential pair and two singletons. Trace labeling for Mixed-mode with second singleton reception and differential drive at Pair 1. S-Parameter for second singleton reception and differential drive at Pair 1.
SYX	One differential pair and two singletons. Trace labeling for Mixed-mode with second singleton reception and first singleton drive. S-Parameter for second singleton reception and first singleton drive.
SYY	One differential pair and two singletons. Trace labeling for Mixed-mode with second singleton reception and second singleton drive. S-Parameter for second singleton reception and second singleton drive.
TCP	Transmission Control Protocol. Part of the Ethernet network communication protocol.
TDS	Anritsu Technical Data Sheet. Document location of the most recent instrument performance specifications.
TFRB	Abbreviation for transmission frequency response calibration both directions. Used in the SCPI command :SENSE{1-16}:CORREction:COLLect[:METHod]:TFRB to simulate the calibration.
TFRF	Abbreviation for transmission frequency response calibration forward direction. Used in the SCPI command :SENSE{1-16}:CORREction:COLLect[:METHod]:TFRF to simulate the calibration.
TFRR	Abbreviation for transmission frequency response calibration reverse direction. Used in the SCPI command :SENSE{1-16}:CORREction:COLLect[:METHod]:TFRR to simulate the calibration.
TLine	A defined transmission line with specifications for Impedance (Ohms), Length (meters), Loss (dB/mm), @ Frequency (GHz), and Dielectric Value. Note that programmatically, length is entered in meters. From the user interface, length is usually entered in millimeters. Available if the instrument is in 2-Port VNA mode.
T-Line	Transmission line
TLINEFour	Allows two separate through (“thru”) lines to be used. In separate commands, each link is defined by Length (meters), @ Frequency (GHz), Z0-Odd (Ohms), Loss-Odd (dB/mm), Dielectric Odd (unitless number), Z0Even (Ohms), Loss-Even (dB/mm), and Dielectric Even (unitless number). Note that programmatically, length is entered in meters. From the user interface, length is usually entered in millimeters. Available if the instrument is in 4-Port VNA mode.
TMS	True Mode Stimulus
Toggle Button	A software button that toggles between two or more states such as ON and OFF or Port 1 and Port 2.

Abbreviation or Term	Meaning / Definition (14 of 14)
TR	Instrument mode. Transmission/reflection mode.
Transf Transf.	Transfer Transformation
Triple Offset Short	Calibration method. Short-short-short-thru. Commonly abbreviated as “SSST.”
TRL	Thru Reflect Line Calibration method. See LRL.
TRM	Thru Reflect Match Calibration method. See ALRM.
Tr Tr.	Trace
TS	Troubleshooting
TS Mode	Troubleshooting Mode
TTL	Transistor-Transistor Logic
U	Units
um	Distance units abbreviation. Micrometer.
Units/Div	SCALE menu toolbar function. Measurement units per trace display division.
us	Time units abbreviation. Microsecond.
USB	Universal Serial Bus
USB Memory Device	<p>Also called a “USB flash drive”, “USB stick”, “thumb drive”, or “memory stick.” In the context of Anritsu documentation, a USB memory device is used to transfer calibration, certification, and/or operating system updates to the MS46x20A instrument.</p> <p>When the instrument interface or hardware uses another term such as “Calibration Memory Device,” its first use is always followed by the “USB Memory Device” in parenthesis.</p> <p>For example: “...use the Calibration Memory Device (USB Memory Device) to load the characterization parameters for the calibration kit...”</p>
USB stick	See USB Memory Device.
UTF	Universal Test Fixture
V	Volts Voltage
V AC	Volts Alternating Current.
V Connector™	Anritsu Company trademarked connector name. Connector type. A 1.85 mm coaxial connector with a rated frequency range from DC to 65 GHz. V Connector is a trademark of Anritsu Company.
V DC	Volts Direct Current
VCO	Voltage Control Oscillator
VISA	Virtual Instrument System Architecture
VNA	Vector Network Analyzer
VSWR	Voltage Standing Wave Ratio

Subject Index

A

AC Power Rocker Switch 3-3
 airflow 3-2
 altitude, operating 3-2
 Antivirus Protection B-1
 APPLICATION Drop-Down Menu 4-10
 Application Icon 4-16
 Auto-Return Button Group 4-31
 Average Icon 4-16

B

Back Button 4-27
 Button Selection Icon 4-30, 4-31

C

CALIBRATION Drop-Down Menu 4-10
 Calibration Icon 4-16
 Calibration Kits 1-2
 Calibration Verification Interval 3-12
 Ch->Max Icon 4-16
 Ch->Next Icon 4-17
 Ch->Prev Icon 4-17
 Channel Status Display 4-34
 Completion Checkmark Button 4-30, 4-32
 Complex Impedance 4-39
 Configuring TCP/IP Ethernet 3-6
 Connecting External Devices 3-2
 Connectors 2-1
 Continue Icon 4-16
 cooling, during operation 3-2
 Custom Icon 1 4-17
 Custom Icon 2 4-17
 Custom Icon 3 4-17
 Custom Icon 4 4-17
 Custom Icon 5 4-17

D

Dialog Boxes 4-32
 Dimensions B-7
 Display Areas 4-2
 Display Icon 4-18
 DRAM and Flash Memory B-1

E

EEPROM, updating C-3
 Enhancing Information Security B-1
 Environment 3-2
 environment
 storage B-7
 Ethernet 1-2, 3-6
 External Devices 3-5

External XGA/VGA Monitor 3-5

F

FILE Drop-Down Menu 4-7
 File Icon 4-18
 Firmware, updating C-3
 Freq Icon 4-18
 Front Panel 2-1

G

Group Delay 4-39, 4-41
 Group Delay Graphs 4-48

H

Hard Drive Removal and Installation B-6
 HELP Drop-Down Menu 4-13
 Hold Icon 4-18
 Home Button 4-27
 humidity, operating 3-2

I

Icon Toolbar 4-15
 Icon Toolbar Functions 4-15
 Imaginary 4-40
 Impedance 4-40
 Information Security B-1
 Initial Inspection 3-1
 Inspection 3-1
 Installation 3-1
 installation category 3-2
 Instrument Status 4-33
 Instrument Status Display Abbreviations 4-33
 Internal Drive B-1

K

Keyboard 3-5

L

LAN TCP/IP 3-6
 Limit Lines 4-53
 Linear Mag 4-40
 Linear Magnitude and Phase 4-41
 Log Mag 4-40
 Log Magnitude and Phase 4-41

M

Main Screen 4-1
 Maintaining Operating System Integrity B-1
 Marker Icon 4-19
 Marker-> Pk Rt Icon 4-19

Marker->Max Icon	4-18
Marker->Min Icon	4-18
Marker->Off	4-19
Marker->Peak Icon	4-19
Marker->Pk Lft Icon	4-19
MEASUREMENT Drop-Down Menu	4-10
Measurement Icon	4-19
Menu Bar	4-6
Menu Bar Drop-Down Menus	4-7
Menu Navigation Buttons	4-27
Monitor	3-5
Mouse	3-5
mouse	1-2

N

Next Button	4-27
-------------	------

O

Operate Mode	3-3
Operating System Integrity	B-1
Optional Icon Toolbar Functions	4-16
Options	1-1

P

Phase	4-40
Phase and Magnitude	4-39
phase, of power supply	3-2
Plug-and-Play	3-6
Polar Graphs	4-49
Power Icon	4-19
Power Requirements	3-2
Power-On/Power-Off Procedure	3-3
Preparation for Use	3-1
Preset Icon	4-19
Previous	1-3
Print Icon	4-20

R

Rack Mount Installation	B-4
Real	4-40
Real and Imaginary	4-39, 4-41
Rear Panel	2-1, 3-5
Rear Panel Ports and Connectors	2-2
Recovery	B-3
Rectilinear Paired Graphs	4-45
Rectilinear Single Graph	4-44
Reference Lines	4-50, 4-51
Reference Position	4-50
Response Icon	4-20

S

Scale Icon	4-20
Security	B-1
Shipment	B-7
shipping instrument	B-7
Smith (R + jX)	4-41
Smith Charts	4-46
Splash Screen	3-4
Standby Mode	3-3
Startup Splash Screen	3-4
Storage	B-7
storage environment	B-7
Sweep Icon	4-20
SWR	4-40
System Icon	4-20
System Identification	1-2

T

temperature, operating	3-2
time, warm-up	3-3
Toolbar	4-29
Tr->Max Icon	4-20
Tr->Next Icon	4-21
TRACE Drop-Down Menu	4-8
Trace Icon	4-20
Trace Label Abbreviations	4-43
Traces	4-4, 4-36, 4-38

U

Unpacking the Product	3-1
Updates	B-2
Updating firmware (EEPROM)	C-3
USB keyboard	1-2
User Input	1-3
User Interface Navigation	1-3

V

ventilation	3-2
Verification Kits	1-2
voltage, of power supply	3-2

W

Warm-up Time	3-3
warm-up time	3-3
Windows configuration utilities	3-7
Windows Updates	B-2

Anritsu



10410-00335



AA



Anritsu utilizes recycled paper and environmentally conscious inks and toner.

Anritsu Company
490 Jarvis Drive
Morgan Hill, CA 95037-2809
USA

<http://www.anritsu.com>