

Keysight InfiniiVision 3000T X-Series Oscilloscopes

Service Guide

Notices

© Keysight Technologies, Inc. 2008-2021

No part of this manual may be reproduced in any form or by any means (including electronic storage and retrieval or translation into a foreign language) without prior agreement and written consent from Keysight Technologies, Inc. as governed by United States and international copyright laws.

Manual Part Number

75037-97086

Edition

September 2021

Available in electronic format only

Published by:
Keysight Technologies, Inc.
1900 Garden of the Gods Road
Colorado Springs, CO 80907 USA

Warranty

The material contained in this document is provided "as is," and is subject to being changed, without notice, in future editions. Further, to the maximum extent permitted by applicable law, Keysight disclaims all warranties, either express or implied, with regard to this manual and any information contained herein, including but not limited to the implied warranties of merchantability and fitness for a particular purpose. Keysight shall not be liable for errors or for incidental or consequential damages in connection with the furnishing, use, or performance of this document or of any information contained herein. Should Keysight and the user have a separate written agreement with warranty terms covering the material in this document that conflict with these terms, the warranty terms in the separate agreement shall control.

Technology Licenses

The hardware and/or software described in this document are furnished under a license

and may be used or copied only in accordance with the terms of such license.

U.S. Government Rights

The Software is "commercial computer software," as defined by Federal Acquisition Regulation ("FAR") 2.101. Pursuant to FAR 12.212 and 27.405-3 and Department of Defense FAR Supplement ("DFARS") 227.7202, the U.S. government acquires commercial computer software under the same terms by which the software is customarily provided to the public. Accordingly, Keysight provides the Software to U.S. government customers under its standard commercial license, which is embodied in its End User License Agreement (EULA), a copy of which can be found at www.keysight.com/find/sweula. The license set forth in the EULA represents the exclusive authority by which the U.S. government may use, modify, distribute, or disclose the Software. The EULA and the license set forth therein, does not require or permit, among other things, that Keysight: (1) Furnish technical information related to commercial computer software or commercial computer software documentation that is not customarily provided to the public; or (2) Relinquish to, or otherwise provide, the government rights in excess of these rights customarily provided to the public to use, modify, reproduce, release, perform, display, or disclose commercial computer software or commercial computer software documentation. No additional government requirements beyond those set forth in the EULA shall apply, except to the extent that those terms, rights, or licenses are explicitly required from all providers of commercial computer software pursuant to the FAR and the DFARS and are set forth specifically in writing elsewhere in the EULA. Keysight shall be under no obligation to update, revise or otherwise modify the Software. With respect to any technical data as defined by FAR 2.101, pursuant to FAR 12.211 and 27.404.2 and DFARS 227.7102, the U.S. government

acquires no greater than Limited Rights as defined in FAR 27.401 or DFAR 227.7103-5 (c), as applicable in any technical data.

Safety Notices

This product has been designed and tested in accordance with accepted industry standards, and has been supplied in a safe condition. The documentation contains information and warnings that must be followed by the user to ensure safe operation and to maintain the product in a safe condition.

CAUTION

A **CAUTION** notice denotes a hazard. It calls attention to an operating procedure, practice, or the like that, if not correctly performed or adhered to, could result in damage to the product or loss of important data. Do not proceed beyond a **CAUTION** notice until the indicated conditions are fully understood and met.

WARNING

A **WARNING** notice denotes a hazard. It calls attention to an operating procedure, practice, or the like that, if not correctly performed or adhered to, could result in personal injury or death. Do not proceed beyond a **WARNING** notice until the indicated conditions are fully understood and met.

In This Service Guide

This book provides the service information for the Keysight 3000T X-Series oscilloscopes. This manual is divided into these chapters:

1 Characteristics and Specifications

This chapter contains a partial list of characteristics and specifications for the Keysight InfiniiVision 3000T X-Series oscilloscopes.

2 Testing Performance

This chapter explains how to verify correct oscilloscope operation and perform tests to ensure that the oscilloscope meets the performance specifications.

3 Calibrating and Adjusting

This chapter explains how to adjust the oscilloscope for optimum operating performance.

4 Troubleshooting

This chapter begins with suggestions for solving general problems that you may encounter with the oscilloscope. Procedures for troubleshooting the oscilloscope follow the problem solving suggestions.

5 Replacing Assemblies

This chapter describes how to remove assemblies from the 3000T X-Series oscilloscope.

6 Replaceable Parts

This chapter describes how to order replaceable assemblies and parts for the Keysight 3000T X-Series oscilloscopes. It includes diagrams and parts lists for hardware that you can order.

7 Safety Notices

At the front of the book you will find safety notice descriptions and document warranties.

Digital Channels

Because all of the oscilloscopes in the Keysight 3000T X-Series have analog channels, the analog channel topics in this book apply to all instruments. Whenever a topic discusses the digital channels, that information applies only to Mixed-Signal Oscilloscope (MSO) models or DSO models that have been upgraded to an MSO.

Abbreviated instructions for pressing a series of keys

Instructions for pressing a series of keys are written in an abbreviated manner. Instructions for pressing Key1, then pressing Softkey2, then pressing Softkey3 are abbreviated as follows:

Press **[Key1] & Softkey2 & Softkey3**.

The keys may be front panel keys, or softkeys, which are located directly below the oscilloscope display.

Contents

In This Service Guide / 3

Figures / 9

Tables / 13

1 Characteristics and Specifications

Power Requirements / 15

Measurement Category / 16

Measurement Category / 16

Measurement Category Definitions / 16

Transient Withstand Capability / 17

Environmental Conditions / 18

Specifications / 18

Contact us / 18

2 Testing Performance

Overview / 20

List of Test Equipment / 21

Conventions / 22

To construct the test connector (for use with MSO models only) / 23

To test digital channels (MSO models only) / 25

To verify digital channel threshold accuracy (MSO models only) / 26

When to Test / 26

- What to Test / 26
- Verifying Test Results / 26
 - To verify DC vertical gain accuracy / 30
 - To verify dual cursor accuracy / 35
 - To verify bandwidth (-3 dB) / 39
 - To verify time base accuracy / 44
 - To verify trigger sensitivity / 46
 - Test Internal Trigger Sensitivity (all models) / 46
 - Test External Trigger Sensitivity / 49
- Keysight 3000T X-Series Oscilloscopes Performance Test Record / 52
- 3 Calibrating and Adjusting**
 - User Calibration / 57
 - To perform User Cal / 57
 - User Cal Status / 60
- 4 Troubleshooting**
 - Solving General Problems with the Oscilloscope / 62
 - If there is no display / 62
 - If there is no trace display / 63
 - If the trace display is unusual or unexpected / 63
 - If you cannot see a channel / 64
 - Verifying Basic Operation / 65
 - To power-on the oscilloscope / 65
 - To perform hardware self test / 65
 - To perform front panel self test / 66
 - To verify default setup / 66
 - To perform an Auto Scale on the Probe Comp signal / 68
 - To compensate passive probes / 69

Troubleshooting Internal Assemblies /	70
Equipment Required for Troubleshooting Internal Assemblies /	70
To prepare for internal assembly troubleshooting /	70
Flowchart for Troubleshooting Internal Assemblies /	73
System Board Drawings /	74
To check the system board power supply test points /	76
To check the interboard supply connector voltages /	77
To check the line filter board AC output /	79
To check the power switch /	80
To check the power supply DC output /	82
To check the display supplies /	82
To check the keyboard supplies /	83
To check the fan /	84

5 Replacing Assemblies

To remove the front panel knobs /	89
To remove the bucket assembly /	90
To remove the power supply shield /	92
To remove the rear deck assembly /	95
To replace the battery /	102
To remove the touch controller board /	103
To remove the acquisition board /	107
To remove the front panel assembly /	113
To remove the display assembly /	119
To remove the fan assembly /	121
To remove the power supply /	123
To remove the line filter board /	126

6 Replaceable Parts

Ordering Replaceable Parts / 132

Listed Parts / 132

Unlisted Parts / 132

Direct Mail Order System / 132

Exchange Assemblies / 133

Exploded Views / 134

Replaceable Parts List / 136

7 Safety Notices

Warnings / 143

To clean the instrument / 144

Safety Symbols / 144

Index

Figures

- Figure 1. Constructing the 8-by-2 Connector / 24
- Figure 2. Setting Up Equipment for Digital Channel Threshold Accuracy Test / 28
- Figure 3. Setting up Equipment for DC Vertical Gain Accuracy Test / 33
- Figure 4. Using a Blocking Capacitor to Reduce Noise / 34
- Figure 5. Setting up Equipment for Dual Cursor Accuracy Test / 37
- Figure 6. Using a Blocking Capacitor to Reduce Noise / 38
- Figure 7. Setting Up Equipment for Bandwidth (-3 dB) Verification Test / 40
- Figure 8. Setting Up Equipment for Internal Trigger Sensitivity Test / 47
- Figure 9. Setting Up Equipment for 4-Channel External Trigger Sensitivity Test / 50
- Figure 10. User Calibration cable for 2-channel oscilloscope / 59
- Figure 11. User Calibration cable for 4-channel oscilloscope / 59
- Figure 12. Default setup screen / 67
- Figure 13. Example pulses / 69
- Figure 14. Setup for troubleshooting internal assemblies / 71
- Figure 15. System Board Test Points/Connectors - Top Side, Left / 74
- Figure 16. System Board Test Points/Connectors - Top Side, Right / 75
- Figure 17. Line filter board interboard supply connector J108 / 78
- Figure 18. Verify line filter board AC output / 80
- Figure 19. Verify power switch operation / 81
- Figure 20. Location of the Fan Connector / 85
- Figure 21. Removing the front panel knobs / 89
- Figure 22. Removing the bucket screws / 90
- Figure 23. Removing bucket assembly / 91
- Figure 24. Removing the power supply shield screw / 92
- Figure 25. Unclipping the power supply shield right side / 93
- Figure 26. Removing the power supply shield - lift and pull out / 94
- Figure 27. Removing the BNC nuts and washers / 95

Figures

- Figure 28. Removing the top rear deck screws / 96
- Figure 29. Removing the bottom right rear deck screw / 96
- Figure 30. Removing the bottom left rear deck screw / 97
- Figure 31. Removing the bottom rear deck screws / 97
- Figure 32. Removing the option module guide to acquisition board screw / 98
- Figure 33. Disconnecting the interboard supply cable from the acquisition board / 99
- Figure 34. Lifting front bezel latch / 100
- Figure 35. Separating the rear and front decks / 101
- Figure 36. Rear and front decks separated / 101
- Figure 37. Battery location / 102
- Figure 38. Removing the T6 screws (4 channel version) / 107
- Figure 39. Removing the controller board bracket / 108
- Figure 40. Disconnecting keyboard and display cables from acquisition board / 109
- Figure 41. Disconnecting display backlight power cable from acquisition board / 110
- Figure 42. Acquisition board mounting screw locations / 111
- Figure 43. Acquisition board removed from front deck / 112
- Figure 44. Release the bezel clips from the front deck / 113
- Figure 45. All bezel clips released / 114
- Figure 46. HINT: When reinstalling bezel, align ground terminal first / 114
- Figure 47. Gently lift front deck from bezel / 115
- Figure 48. Disconnect the keyboard cable / 115
- Figure 49. Disconnect the softkey board cable / 116
- Figure 50. Unclip the softkey board from the bezel / 117
- Figure 51. Remove the softkey keypad from the bezel / 117
- Figure 52. Unclip the keyboard board from the bezel / 118
- Figure 53. Remove the keyboard keypad from the bezel / 118
- Figure 54. Removing the display assembly / 119
- Figure 55. Display assembly removed / 120
- Figure 56. Disconnecting fan power cable / 121
- Figure 57. Removing fan assembly / 122

- Figure 58. Disconnecting the AC cable / 123
- Figure 59. Disconnecting the interboard supply cable from the line filter board / 124
- Figure 60. Disconnecting the DC cable from the line filter board / 124
- Figure 61. Removing the power supply / 125
- Figure 62. Removing the option module guide / 126
- Figure 63. Disconnecting the ground wire / 127
- Figure 64. Removing the line filter board screws / 128
- Figure 65. Removing the line filter board / 129
- Figure 66. Removing the power switch extender / 130
- Figure 67. Exploded View 1 of 2 / 134
- Figure 68. Exploded View 2 of 2 / 135

Figures

Tables

Table 1. List of test equipment	/ 21
Table 2. Conventions	/ 22
Table 3. Materials required to construct the test connectors	/ 23
Table 4. Equipment Required to Test Digital Channel Threshold Accuracy	/ 26
Table 5. Threshold Accuracy Voltage Test Settings	/ 29
Table 6. DC Vertical Gain Accuracy Test Limits	/ 30
Table 7. Equipment Required to Verify DC Vertical Gain Accuracy	/ 31
Table 8. Settings Used to Verify DC Vertical Gain Accuracy, 3000T X-Series Models	/ 32
Table 9. Equipment Required to Verify Dual Cursor Accuracy	/ 35
Table 10. Settings Used to Verify Dual Cursor Accuracy, 3000T X-Series Models	/ 36
Table 11. Bandwidth (-3 dB) Test Limits	/ 39
Table 12. Equipment Required to Verify Bandwidth (-3 dB)	/ 39
Table 13. Equipment Required to Verify Time Base Accuracy	/ 44
Table 14. Equipment Required to Verify Trigger Sensitivity	/ 46
Table 15. Equipment Required to Troubleshoot the Oscilloscope	/ 70
Table 16. Replaceable Parts	/ 136

1 Characteristics and Specifications

Power Requirements / 15
Measurement Category / 16
Environmental Conditions / 18
Specifications / 18
Contact us / 18

This chapter contains a partial list of characteristics and specifications for the Keysight InfiniiVision 3000T X-Series oscilloscopes.

For a full list of Keysight InfiniiVision 3000T X-Series oscilloscopes characteristics and specifications see the data sheets.

The data sheets are available at www.keysight.com/find/3000TX-Series.

Power Requirements

Line voltage, frequency, and power:

- ~Line 100-120 Vac, 50/60/400 Hz
- 100-240 Vac, 50/60 Hz
- 100 W max

Measurement Category

Measurement Category

The InfiniiVision 3000T X-Series oscilloscopes are not intended to be used for measurements in Measurement Category II, III, or IV..

WARNING

Use this instrument only for measurements within its specified measurement category (not rated for CAT II, III, IV). No transient overvoltage tags allowed.

Measurement Category Definitions

The "Not rated for CAT II, III, IV" measurement category is for measurements performed on circuits not directly connected to MAINS. Examples are measurements on circuits not derived from MAINS, and specially protected (internal) MAINS derived circuits. In the latter case, transient stresses are variable; for that reason, the transient withstand capability of the equipment is made known to the user.

Measurement category II is for measurements performed on circuits directly connected to the low voltage installation. Examples are measurements on household appliances, portable tools and similar equipment.

Measurement category III is for measurements performed in the building installation. Examples are measurements on distribution boards, circuit-breakers, wiring, including cables, bus-bars, junction boxes, switches, socket-outlets in the fixed installation, and equipment for industrial use and some other equipment, for example, stationary motors with permanent connection to the fixed installation.

Measurement category IV is for measurements performed at the source of the low-voltage installation. Examples are electricity meters and measurements on primary overcurrent protection devices and ripple control units.

Transient Withstand Capability

CAUTION

Maximum input voltage for analog inputs

135 Vrms

50 Ω input: 5 Vrms Input protection is enabled in 50 Ω mode, and the 50 Ω load will disconnect if greater than 5 Vrms is detected. However, the inputs could still be damaged, depending on the time constant of the signal. The 50 Ω input protection only functions when the oscilloscope is powered on.

CAUTION

When measuring voltages over 30 V, use a 10:1 probe.

CAUTION

Maximum input voltage for logic channels:

± 40 V peak

Environmental Conditions

Environment	Indoor use only.
Ambient temperature	5 to 55 °C
Humidity	Maximum Relative Humidity (non-condensing): 95% RH up to 40 °C From 40 °C to 55 °C, the maximum % Relative Humidity follows the line of constant dew point
Altitude	4,000 m max
Overvoltage Category	This product is intended to be powered by MAINS that comply to Overvoltage Category II, which is typical of cord-and-plug connected equipment.
Pollution Degree	The InfiniiVision 3000T X-Series oscilloscopes may be operated in environments of Pollution Degree 2 (or Pollution Degree 1).
Pollution Degree Definitions	<p>Pollution Degree 1: No pollution or only dry, non-conductive pollution occurs. The pollution has no influence. Example: A clean room or climate controlled office environment.</p> <p>Pollution Degree 2. Normally only dry non-conductive pollution occurs. Occasionally a temporary conductivity caused by condensation may occur. Example: General indoor environment.</p> <p>Pollution Degree 3: Conductive pollution occurs, or dry, non-conductive pollution occurs which becomes conductive due to condensation which is expected. Example: Sheltered outdoor environment.</p>

Specifications

Please see the *InfiniiVision 3000T X-Series Oscilloscopes Data Sheet* for complete, up-to-date specifications and characteristics.

To download a copy of the data sheet please visit:

www.keysight.com/find/3000TX-Series.

Contact us

To contact Keysight, see: www.keysight.com/find/contactus

2 Testing Performance

Overview / 20

List of Test Equipment / 21

To construct the test connector (for use with MSO models only) / 23

To test digital channels (MSO models only) / 25

To verify digital channel threshold accuracy (MSO models only) / 26

To verify DC vertical gain accuracy / 30

To verify dual cursor accuracy / 35

To verify bandwidth (-3 dB) / 39

To verify time base accuracy / 44

To verify trigger sensitivity / 46

Keysight 3000T X-Series Oscilloscopes Performance Test Record / 52

This chapter explains how to verify correct oscilloscope operation and perform tests to ensure that the oscilloscope meets the performance specifications.

Overview

To completely test and troubleshoot MSO models, create and use the test connector accessory as described in this chapter.

- The test connector is only required for oscilloscopes that have the MSO option licensed (enabled).
- The connector is used in the digital channel threshold accuracy test.
- The test connector keeps electrical distortion to a minimum and makes it easy for you to connect the oscilloscope probes to function generators and measurement equipment.

Let the Equipment Warm Up Before Testing

For accurate test results, let the test equipment and the oscilloscope warm up 30 minutes before testing.

Verifying Test Results

During the tests, record the readings in the Performance Test Record on [page 52](#). To verify whether a test passes, verify that the reading is within the limits in the Performance Test Record.

If a performance test fails

If a performance test fails, first perform the User Cal procedure. Press the following keys to access User Cal: [Utility]→Service→Start User Cal.

List of Test Equipment

Below is a list of test equipment and accessories required to perform the performance test verification procedures.

Table 1 List of test equipment

Equipment	Critical Specifications	Recommended Model/ Part Number
Test connector, 8-by-2*	See page 23 for instructions on building test connector.	n/a
Digital Multimeter	0.1 mV resolution, 0.005% accuracy	Keysight 34401A/34461A
Power Splitter	Outputs differ by 0.15 dB	Keysight 11667A
Precision Source	DC voltage of -5.5 V to 35.5 V, 0.1 mV resolution	Keysight B2912A/B2962A
Signal Generator	25 MHz, 100 MHz, 350 MHz, 500 MHz, and 1 GHz sine waves	Keysight N5171B
Power Meter	1 GHz \pm 3% accuracy	Keysight N1914A
Power Sensor	1 GHz \pm 3% accuracy	Keysight E9304A or N8482A
50 Ω BNC cable (qty 3)	BNC - BNC, 48" length	Keysight 8120-1840 [†]
Cable	Type N (m) 609.6 mm (24 in.)	Keysight 11500B
Probe Cable*	No substitute	16-channel: Keysight N6450-60001 or N2756-60001 8-channel: Keysight N6459-60001 or N2755-60001 [†]
Adapter (qty 2)	BNC(f) to banana(m)	Keysight 1251-2277 [†]
BNC Tee	BNC tee (m) (f) (f)	Keysight 1250-0781 [†] or Pomona 3285
Adapter	Type N (m) to BNC (m)	Keysight 1250-0082 or Pomona 3288 with Pomona 3533
Shorting cap	BNC	Keysight 1250-0774

* Required only for testing digital channels of oscilloscopes that have the MSO option.

Most parts and equipment are available at www.keysight.com. See respective manufacturer's websites for their equipment.

[†] These parts available at www.parts.keysight.com at the time this manual was published.

Table 1 List of test equipment (continued)

Equipment	Critical Specifications	Recommended Model/ Part Number
Blocking capacitor	Note: if a BNC blocking capacitor is not available use an SMA blocking capacitor.	Keysight 11742A + Pomona 4289 + Pomona 5088
Adapter (qty 3)	N(m) to BNC(f)	Keysight 1250-0780
50 Ohm Feedthrough Termination	50 Ω BNC (f) to BNC (m)	Keysight 0960-0301

* Required only for testing digital channels of oscilloscopes that have the MSO option.

Most parts and equipment are available at www.keysight.com. See respective manufacturer's websites for their equipment.

† These parts available at www.parts.keysight.com at the time this manual was published.

Conventions

The following conventions will be used when referring to oscilloscope models throughout this chapter.

Table 2 Conventions

Models	Referred to as:
MSO-X /DSO-X 3012T, MSO-X /DSO-X 3014T	100 MHz Models
MSO-X /DSO-X 3022T, MSO-X /DSO-X 3024T	200 MHz Models
MSO-X /DSO-X 3032T, MSO-X /DSO-X 3034T	350 MHz Models
MSO-X /DSO-X 3052T, MSO-X /DSO-X 3054T	500 MHz Models
MSO-X /DSO-X 3102T, MSO-X /DSO-X 3104T	1 GHz Models

To construct the test connector (for use with MSO models only)

Keysight 3000T X-Series oscilloscopes that have digital channels enabled require the test connector described below. Follow the steps to build the test connector.

Table 3 Materials required to construct the test connectors

Description	Recommended Part	Qty
BNC (f) Connector	Keysight 1250-1032 or Pomona 4578	1
Berg Strip, 8-by-2	3M .100" x .100" Pin Strip Header or similar	1 strip, cut to length (8x2)
Jumper wire		

- 1 Obtain a BNC connector and an 8-by-2 section of Berg strip. A longer strip can be cut to length using wire cutters.
- 2 On one side of the Berg strip, solder a jumper wire to all of the pins (shown in **Figure 1** on page 24).
- 3 On the other side of the Berg strip, solder another jumper wire to all of the pins.
- 4 Solder the center of the BNC connector to a center pin on one of the rows on the Berg strip.
- 5 Solder the ground tab of the BNC connector to a center pin on the other row on the Berg strip.

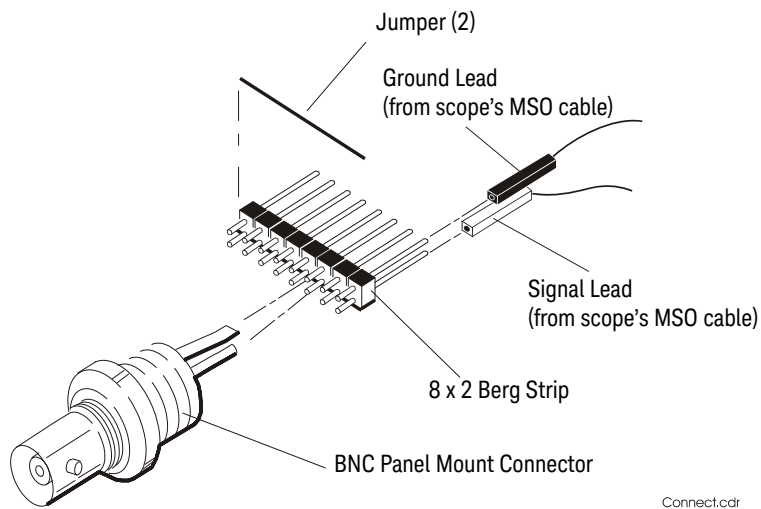

Connect.cdr

Figure 1 Constructing the 8-by-2 Connector

To test digital channels (MSO models only)

The acquisition system testing provides confidence that the acquisition system is functioning correctly. It does not, however, check a particular specification.

- 1** Disconnect all probes from the circuit under test and from any other input source.
- 2** Using probe leads and grabbers, connect digital channels D0, D1, D2, and D3 to the Probe Comp signal on the center of the front panel.
- 3** Press the **[AutoScale]** key.

If four square waves appear, the acquisition system is functioning correctly.

If the square waves do not appear, go to the “Troubleshooting” chapter. Then return here to finish testing the digital channels.

- 4** Disconnect the digital channels from the calibration point.
- 5** Use steps 2 and 3 to test the following sets of digital channels. After you test one set of digital channels, remove them before connecting the next set.
 - D4, D5, D6, D7
 - D8, D9, D10, D11
 - D12, D13, D14, D15

To verify digital channel threshold accuracy (MSO models only)

This test verifies the digital channel threshold accuracy specification of the Keysight 3000T X-Series oscilloscopes.

Threshold accuracy test limits: $\pm(100 \text{ mV} + 3\% \text{ of threshold setting})$

When to Test

You should perform this test every three years or after 6000 hours of operation, whichever comes first.

What to Test

Use these instructions to test the threshold settings of digital channels D7-D0. Then, use the same instructions to test digital channels D15-D8.

Verifying Test Results

After each threshold test, record the voltage reading in the Performance Test Record on [page 52](#). To verify whether a test passes, verify that the voltage reading is within the limits in the Performance Test Record.

Table 4 Equipment Required to Test Digital Channel Threshold Accuracy

Equipment	Critical Specifications	Recommended Model/Part
Digital Multimeter	0.1 mV resolution, 0.005% accuracy	Keysight 34401A/34461A
Precision Source	DC voltage of -5.5 V to 5.5 V, 10 mV resolution	Keysight B2912A/B2962A
Adapter (qty 2)	BNC(f) to banana(m)	Keysight 1251-2277
BNC Tee	BNC tee (m) (f) (f)	Keysight 1250-0781 or Pomona 3285
50 Ω BNC Cable (qty 2)	BNC - BNC, 48" length	Keysight 8120-1840
BNC Test Connector, 8-by-2		User-built (See page 23)
Probe Cable	No substitute	16-channel: Keysight N6450-60001 or N2756-60001 8-channel: Keysight N6459-60001 or N2755-60001

- 1 Turn on the test equipment and the oscilloscope. Let them warm up for 30 minutes before starting the test.
- 2 Set up the precision source.
 - a Set the precision source to provide a DC offset voltage at the Channel 1 output.

Note: Set the Low Force terminal of the Precision Source to its "Floating" state to prevent offset error caused by ground loop current from the Precision Source ground to the DUT ground.
 - b Use the multimeter to monitor the precision source DC output voltage.
- 3 Use the 8-by-2 test connector and the BNC cable assembly to connect digital channels D0-D7 to one side of the BNC Tee. Then connect the D0-D7 ground lead to the ground side of the 8-by-2 connector. See [Figure 2](#).

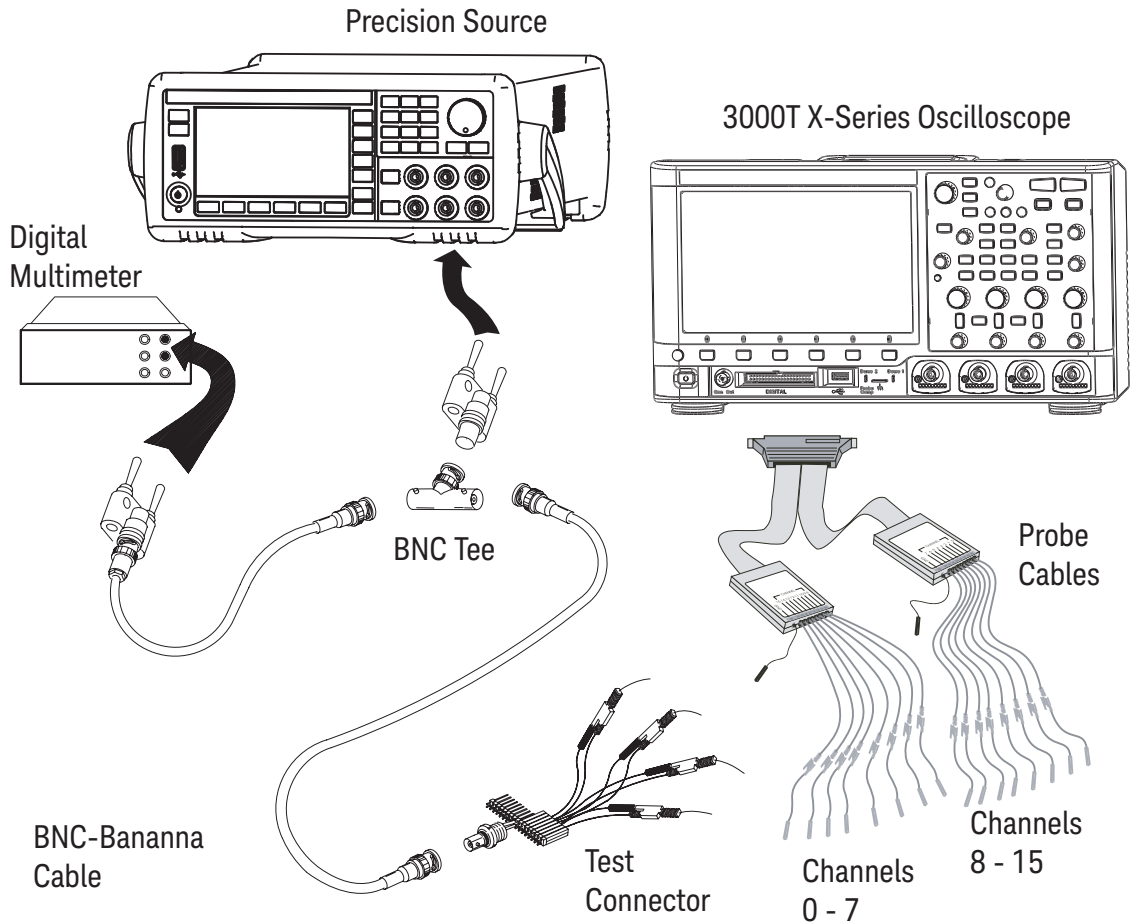

Figure 2 Setting Up Equipment for Digital Channel Threshold Accuracy Test

- 4 Use a BNC-bananna cable to connect the multimeter to the other side of the BNC Tee.
- 5 Connect the BNC Tee to the Channel 1 output of the precision source as shown in **Figure 2**.
- 6 On the oscilloscope, press the **[Digital]** key, then press the **Thresholds** softkey, then press the **D7 - D0** softkey repeatedly until the check mark is next to **User**.

- 7 Press the **User** softkey to the right of the **D7 - D0** softkey, then turn the Entry knob (↻) on the front panel of the oscilloscope to set the threshold test settings as shown in [Table 5](#).

Table 5 Threshold Accuracy Voltage Test Settings

Threshold voltage setting (in oscilloscope User softkey)	DC offset voltage setting (on precision source)	Limits
+5.00 V	+5.250 V ±1 mV dc	Lower limit = +4.750 V Upper limit = +5.250 V
-5.00 V	-4.750 V ±1 mV dc	Lower limit = -5.250 V Upper limit = -4.750 V
0.00 V	+100m V ±1 mV dc	Upper limit = +100 mV Lower limit = -100 mV

- 8 Do the following steps for each of the threshold voltage levels shown in [Table 5](#).

- a Set the threshold voltage shown in the **User** softkey using the Entry knob on the oscilloscope.
- b Enter the corresponding DC offset voltage on the precision source front panel. Then use the multimeter to verify the voltage.

Digital channel activity indicators are displayed on the status line at the top of the oscilloscope display. The activity indicators for D7-D0 should show all of the channels at digital high levels.

- c Use the knob on the precision source to decrease the offset voltage, in increments of 10 mV, until the activity indicators for digital channels D7-D0 are all at digital low levels. Record the precision source voltage in the Performance Test Record (see [page 52](#)).
- d Use the knob on the precision source to increase the offset voltage, in increments of 10 mV, until the activity indicators for digital channels D7-D0 are all at digital high levels. Record the precision source voltage in the Performance Test Record (see [page 52](#)).

Before proceeding to the next step, make sure that you have recorded the precision source voltage levels for each of the threshold settings shown in [Table 5](#).

- 9 When testing 3000T X-Series MSOs, use the 8-by-2 test connector to connect digital channels D15-D8 to the output of the precision source. Then connect the D15-D8 ground lead to the ground side of the 8-by-2 connector.
- 10 Repeat this procedure (steps 6 through 8) for digital channels D15-D8 to verify threshold accuracy and record the threshold levels in the Performance Test Record (see [page 52](#)). Be sure to set the thresholds with the **User** softkey for the appropriate set of channels.

To verify DC vertical gain accuracy

This test verifies the accuracy of the analog channel DC vertical gain for each channel.

In this test, you will measure the dc voltage output of a precision source using the oscilloscope's **Average - Full Screen** voltage measurement and compare the results with the multimeter reading.

Table 6 DC Vertical Gain Accuracy Test Limits

Models	Test Limits	Notes
3000T X-Series	±2.0% of full scale	<ul style="list-style-type: none"> ▪ Full scale is defined as 32 mV on the 2 mV/div range and the 1 mV/div range. ▪ Full scale on all other ranges is defined as 8 divisions times the V/div setting.

Table 7 Equipment Required to Verify DC Vertical Gain Accuracy

Equipment	Critical Specifications	Recommended Model/Part
Precision Source	DC voltage of 7 mV to 35 V, 0.1 mV resolution	Keysight B2912A/B2962A
Digital multimeter	Better than 0.01% accuracy	Keysight 34401A/34461A
50 Ω BNC Cable (qty 2)	BNC - BNC, 48" length	Keysight 8120-1840
Adapter (qty 2)	BNC (f) to banana (m)	Keysight 1251-2277
BNC Tee	BNC tee (m) (f) (f)	Keysight 1250-0781 or Pomona 3285
Shorting cap	BNC	Keysight 1250-0774
Blocking capacitor	Note: if a BNC blocking capacitor is not available use an SMA blocking capacitor.	Keysight 11742A + Pomona 4289 + Pomona 5088

- 1 Press [**Save/Recall**] > **Default/Erase** > **Factory Default** to recall the factory default setup.
- 2 Set up the oscilloscope.
 - a Adjust the horizontal scale to **200.0 us/div**.
 - b Set the Volts/Div setting to the value in the first line in **Table 8**.
 - c Adjust the channel's vertical position knob to place the baseline (reference level) at 0.5 major division from the bottom of the display.

Table 8 Settings Used to Verify DC Vertical Gain Accuracy, 3000T X-Series Models

Volts/Div Setting	Precision Source Setting	Test Limits		
5 V/Div	35 V	34.2 V	to	35.8 V
2 V/Div	14 V	13.68 V	to	14.32 V
1 V/Div	7 V	6.84 V	to	7.16 V
500 mV/Div	3.5 V	3.42 V	to	3.58 V
200 mV/Div	1.4 V	1.368 V	to	1.432 V
100 mV/Div	700 mV	684 mV	to	716 mV
50 mV/Div	350 mV	342 mV	to	358 mV
20 mV/Div	140 mV	136.8 mV	to	143.2 mV
10 mV/Div	70 mV	68.4 mV	to	71.6 mV
5 mV/Div ¹	35 mV	34.2 mV	to	35.8 mV
2 mV/Div ^{1, 2}	14 mV	13.36 mV	to	14.64 mV
1 mV/Div ^{1, 2}	7 mV	6.36 mV	to	7.64 mV

¹ A blocking capacitor is required at this range to reduce noise. See ["Use a Blocking Capacitor to Reduce Noise"](#) on page 34.

² Full scale is defined as 32 mV on the 2 mV/div range and the 1 mV/div range. Full scale on all other ranges is defined as 8 divisions times the V/div setting.

- d Press the **[Acquire]** key.
 - e Then press the **Acq Mode** softkey and select **Averaging**.
 - f Then press the **#Avgs** softkey and set it to 64.
- Wait a few seconds for the measurement to settle.
- 3 Add a measurement for the average voltage:
 - a Press the **[Meas]** key.
 - b Press **Source**; then, turn the Entry knob (labeled  on the front panel) to select the channel you are testing.
 - c Press **Type**; then, turn the Entry knob to select **Average - Full Screen**, and press **Add Measurement**.

- 4 Read the “current” average voltage value as V1.
- 5 Use the BNC tee and cables to connect the precision source /power supply to both the oscilloscope and the multimeter (see **Figure 3**).

Note: Set the Low Force terminal of the Precision Source to its "Floating" state to prevent offset error caused by ground loop current from the Precision Source ground to the DUT ground.

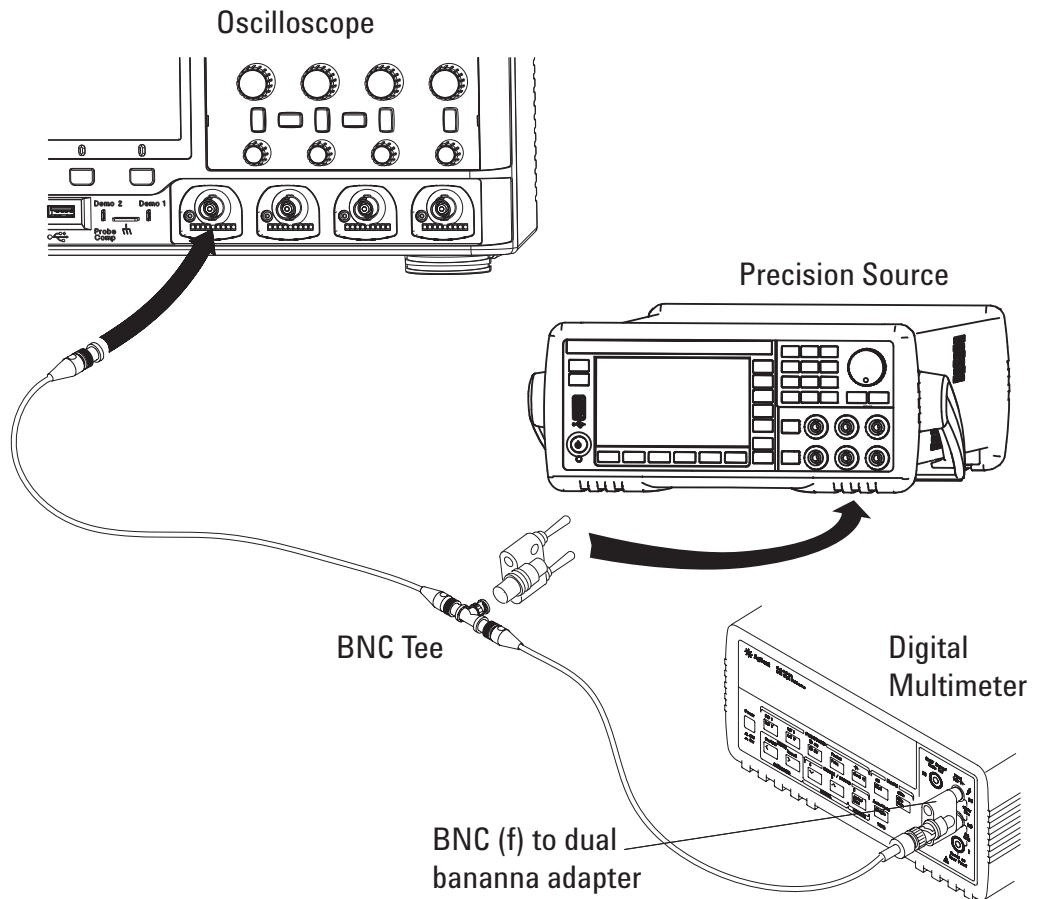

Figure 3 Setting up Equipment for DC Vertical Gain Accuracy Test

- 6 Adjust the output so that the multimeter reading displays the first Volts/div precision source setting value in **Table 8**.
- 7 Disconnect the multimeter.
- 8 Wait until the measurement settles.
- 9 Read the “current” average voltage value again as V2.
- 10 Calculate the difference $V2 - V1$.

The difference in average voltage readings should be within the test limits of **Table 8**.

If a result is not within the test limits, go to the “Troubleshooting” chapter. Then return here.

- 11 Disconnect the precision source from the oscilloscope.
- 12 Repeat this procedure to check the DC vertical gain accuracy with the remaining Volts/div setting values in **Table 8**.
- 13 Finally, repeat this procedure for the remaining channels to be tested.

Use a Blocking Capacitor to Reduce Noise

On the more sensitive ranges, such as 1 mV/div, 2 mV/div, and 5 mV/div, noise may be a factor. To eliminate the noise, add a BNC Tee, blocking capacitor, and shorting cap at the oscilloscope channel input to shunt the noise to ground. See **Figure 4**. If a BNC capacitor is not available, use an SMA blocking capacitor, adapter, and cap. See “**Blocking capacitor**” in the equipment list on **page 22** for details.

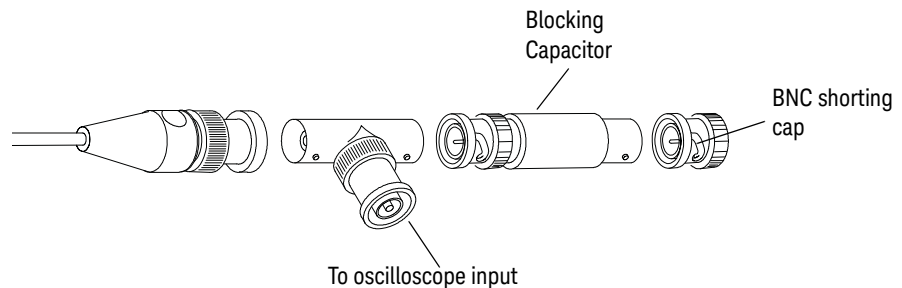

Figure 4 Using a Blocking Capacitor to Reduce Noise

To verify dual cursor accuracy

This test verifies the dual cursor accuracy for each analog channel.

This test is similar to the test for verifying the DC vertical gain, except you will measure the dc voltage output of a precision source using dual cursors on the oscilloscope and compare the results with the multimeter reading.

Dual cursor accuracy test limits: \pm [DC vertical gain accuracy + 0.5% full scale]

For the DC vertical gain accuracy test limits, see [Table 6](#) on page 30.

Table 9 Equipment Required to Verify Dual Cursor Accuracy

Equipment	Critical Specifications	Recommended Model/Part
Precision Source	DC voltage of 7 mV to 35 V, 0.1 mV resolution	Keysight B2912A/B2962A
Digital multimeter	Better than 0.01% accuracy	Keysight 34401A/34461A
50 Ω BNC Cable (qty 2)	BNC - BNC, 48" length	Keysight 8120-1840
Adapter (qty 2)	BNC (f) to banana (m)	Keysight 1251-2277
BNC Tee	BNC tee (m) (f) (f)	Keysight 1250-0781 or Pomona 3285
Shorting cap	BNC	Keysight 1250-0774
Blocking capacitor	Note: if a BNC blocking capacitor is not available use an SMA blocking capacitor.	Keysight 11742A + Pomona 4289 + Pomona 5088

- 1 Press [**Save/Recall**] > **Default/Erase** > **Factory Default** to recall the factory default setup.
- 2 Set up the oscilloscope.
 - a Set the Volts/Div setting to the value in the first line in [Table 10](#).
 - b Adjust the channel 1 position knob to place the baseline at 0.5 major division from the bottom of the display.

Table 10 Settings Used to Verify Dual Cursor Accuracy, 3000T X-Series Models

Volts/Div Setting	Precision Source Setting	Test Limits		
5 V/Div	35 V	34.0 V	to	36.0 V
2 V/Div	14 V	13.6 V	to	14.4 V
1 V/Div	7 V	6.8 V	to	7.2 V
500 mV/Div	3.5 V	3.4 V	to	3.6 V
200 mV/Div	1.4 V	1.36 V	to	1.44 V
100 mV/Div	700 mV	680 mV	to	720 mV
50 mV/Div	350 mV	340 mV	to	360 mV
20 mV/Div	140 mV	136 mV	to	144 mV
10 mV/Div	70 mV	68 mV	to	72 mV
5 mV/Div ¹	35 mV	34 mV	to	36 mV
2 mV/Div ^{1, 2}	14 mV	13.2 mV	to	14.8 mV
1 mV/Div ^{1, 2}	7 mV	6.2 mV	to	7.8 mV

¹ A blocking capacitor is required at this range to reduce noise. See **"Use a Blocking Capacitor to Reduce Noise"** on page 38.

² Full scale is defined as 32 mV on the 2 mV/div range and the 1 mV/div range. Full scale on all other ranges is defined as 8 divisions times the V/div setting.

- c Press the **[Acquire]** key.
 - d Then press the **Acq Mode** softkey and select **Averaging**.
 - e Then press the **#Avgs** softkey and set it to 64.
- Wait a few seconds for the measurement to settle.
- 3 Press the **[Cursors]** key, set the **Mode** softkey to **Normal**, then press the **X Y** softkey and select **Y**. Press the **Y1** softkey, then use the Entry knob (labeled  on the front panel) to set the Y1 cursor on the baseline of the signal.
 - 4 Use the BNC tee and cables to connect the precision source /power supply to both the oscilloscope and the multimeter (see **Figure 5**).

Note: Set the Low Force terminal of the Precision Source to its "Floating" state to prevent offset error caused by ground loop current from the Precision Source ground to the DUT ground.

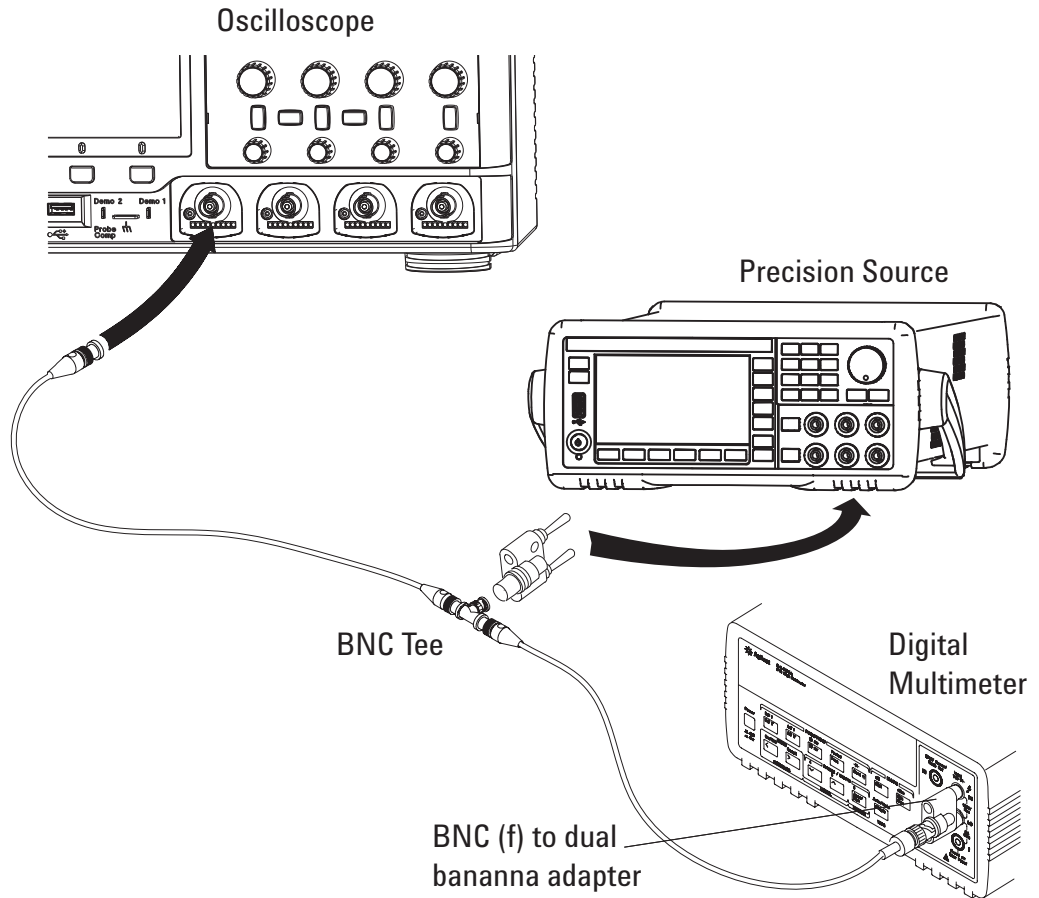

Figure 5 Setting up Equipment for Dual Cursor Accuracy Test

- 5 Adjust the output so that the multimeter reading displays the first Volts/div precision source setting value in [Table 10](#).
- 6 Disconnect the multimeter.
- 7 Wait until the measurement settles.

- 8 Press the **Y2** softkey, then position the Y2 cursor to the center of the voltage trace using the Entry knob.

The ΔY value on the lower line of the display should be within the test limits of **Table 10**.

If a result is not within the test limits, go to the “Troubleshooting” chapter. Then return here.

- 9 Disconnect the precision source from the oscilloscope.
- 10 Repeat this procedure to check the dual cursor accuracy with the remaining Volts/div setting values in **Table 10**.
- 11 Finally, repeat this procedure for the remaining channels to be tested.

Use a Blocking Capacitor to Reduce Noise

On the more sensitive ranges, such as 1 mV/div, 2 mV/div, and 5 mV/div, noise may be a factor. To eliminate the noise, add a BNC Tee, blocking capacitor, and shorting cap at the oscilloscope channel input to shunt the noise to ground. See **Figure 6**. If a BNC capacitor is not available, use an SMA blocking capacitor, adapter, and cap. See “**Blocking capacitor** in the equipment list on **page 22** for details.

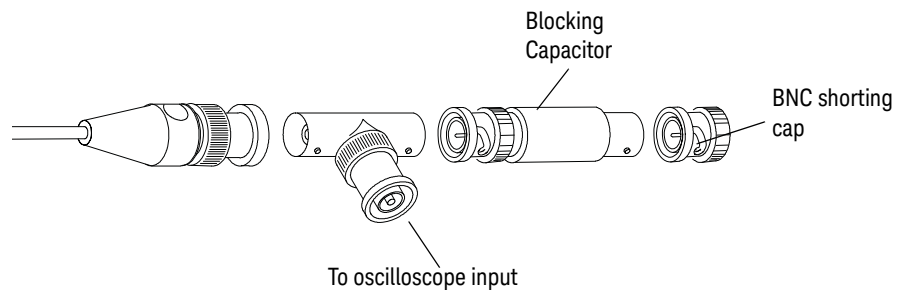

Figure 6 Using a Blocking Capacitor to Reduce Noise

To verify bandwidth (-3 dB)

This test checks the bandwidth (-3 dB) of the oscilloscope. In this test you will use a signal generator and a power meter.

Table 11 Bandwidth (-3 dB) Test Limits

Models	Test Limits
1 GHz Models	All channels (-3 dB), dc to 1 GHz
500 MHz Models	All channels (-3 dB), dc to 500 MHz
350 MHz Models	All channels (-3 dB), dc to 350 MHz
200 MHz Models	All channels (-3 dB), dc to 200 MHz
100 MHz Models	All channels (-3 dB), dc to 100 MHz

Table 12 Equipment Required to Verify Bandwidth (-3 dB)

Equipment	Critical Specifications	Recommended Model/Part
Signal Generator	100 kHz - 1 GHz at 200 mVrms	Keysight N5171B
Power Meter	1 MHz - 1 GHz $\pm 3\%$ accuracy	Keysight N1914A
Power Sensor	1 MHz - 1 GHz $\pm 3\%$ accuracy	Keysight E9304A or N8482A
Power Splitter	outputs differ by < 0.15 dB	Keysight 11667A
Cable	Type N (m) 24 inch	Keysight 11500B
Adapter	Type N (m) to BNC (m)	Keysight 1250-0082 or Pomona 3288 with Pomona 3533

- 1 Connect the equipment (see [Figure 7](#)).
 - a Use the N cable to connect the signal generator to the input of the power splitter input.
 - b Connect the power sensor to one output of the power splitter.
 - c Use an N-to-BNC adapter to connect the other splitter output to the channel 1 input.

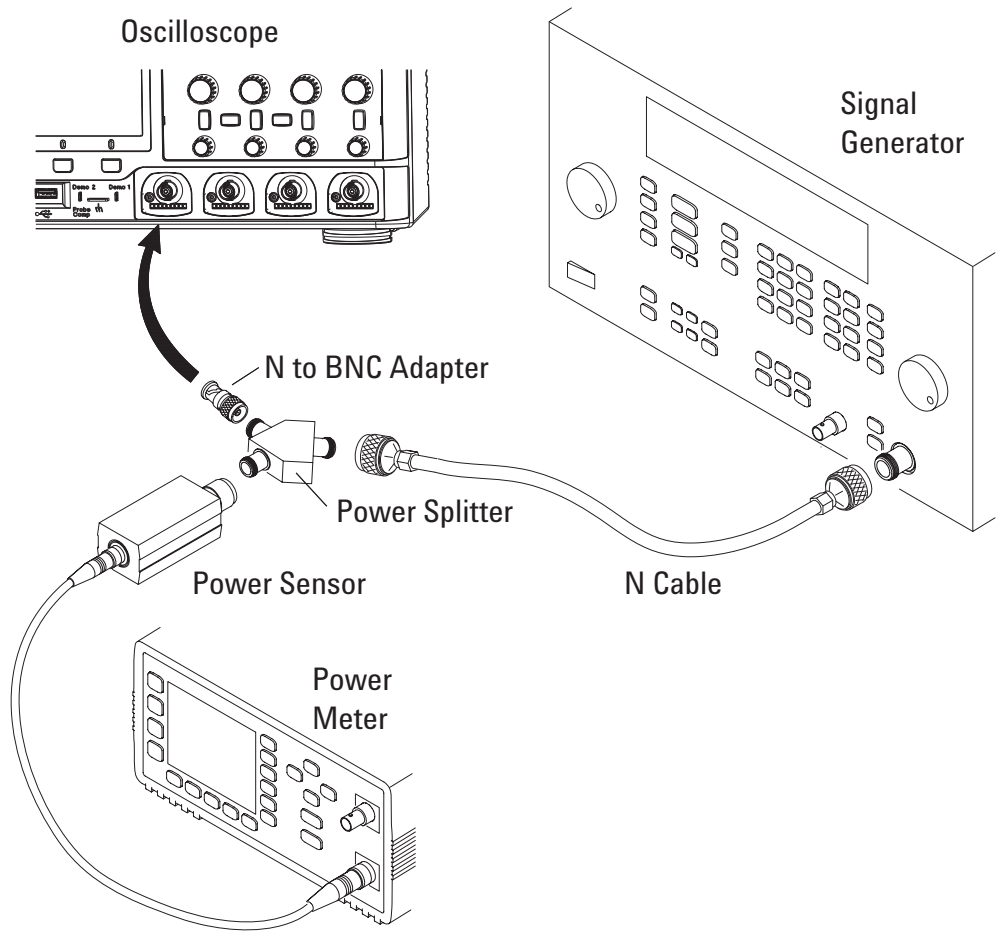

Figure 7 Setting Up Equipment for Bandwidth (-3 dB) Verification Test

2 Set up the power meter.

Set the power meter to display measurements in units of watts.

- 3 Set up the oscilloscope.
 - a Press the **[Default Setup]** key.
 - b Set channel 1 **Coupling** to **DC**.
 - c Set channel 1 **Imped** to **50 Ohm**.
 - d Set the time base to 500 ns/div.
 - e Set the Volts/Div for channel 1 to 200 mV/div.
 - f Press the **[Acquire]** key, then press the **Averaging** softkey.
 - g Turn the Entry knob to set **# Avgs** to 8 averages.
- 4 Set the signal generator for 1 MHz and six divisions of amplitude.
 The signal on the oscilloscope screen should be about five cycles at six divisions amplitude.
- 5 Set up the Amplitude measurement
 - a Press the **[Meas]** key.
 - b Press the **Clear Meas** softkey and then the **Clear All** softkey.
 - c Press the **Type:** softkey and use the Entry knob to select **AC RMS - Full Screen (Std Deviation)** within the select menu.
 - d Press the **Add Measurement** softkey.
- 6 Note the oscilloscope AC RMS - FS(1) reading at the bottom of the screen.
 (This is the RMS value with any dc offset removed.)
- 7 Set the power meter Cal Factor % to the 1 MHz value on the calibration chart on the power sensor.
- 8 Note the reading on the power meter and covert to V_{rms} using the expression:

$$V_{in_{1MHz}} = \sqrt{P_{meas_{1MHz}} \times 50\Omega}$$

For example, if the power meter reading is 892 μ W, then $V_{in_{1MHz}} = (892 \times 10^{-6} * 50\Omega)^{1/2} = 211.2 \text{ mV}_{rms}$.

- 9 Change the signal generator output frequency according to the maximum frequency for the oscilloscope using the following:
 - 1 GHz Models: 1 GHz
 - 500 MHz Models: 500 MHz
 - 350 MHz Models: 350 MHz
 - 200 MHz Models: 200 MHz
 - 100 MHz Models: 100 MHz
- 10 Referencing the frequency from step 9, set the power meter Cal Factor % to the frequency value on the calibration chart on the power sensor.
- 11 Set the oscilloscope sweep speed according to the following:
 - 1 GHz Models: 500 ps/div
 - 500 MHz Models: 1 ns/div
 - 350 MHz Models: 2 ns/div
 - 200 MHz Models: 2 ns/div
 - 100 MHz Models: 5 ns/div
- 12 Note the oscilloscope Std Dev(1) reading at the bottom of the screen.
- 13 Note the reading on the power meter and convert to V_{rms} using the expression:

$$V_{in_{maxfreq}} = \sqrt{P_{meas_{maxfreq}} \times 50\Omega}$$

- 14 Calculate the response using the expression:

$$\text{response(dB)} = 20 \log_{10} \left[\frac{V_{out_{maxfreq}} / V_{in_{maxfreq}}}{V_{out_{1MHz}} / V_{in_{1MHz}}} \right]$$

Example

If:
 $P_{meas_{1MHz}} = 892 \text{ uW}$
 $\text{Std Dev}(n)_{1MHz} = 210.4 \text{ mV}$
 $P_{meas_{maxfreq}} = 687 \text{ uW}$
 $\text{Std Dev}(n)_{maxfreq} = 161.6 \text{ mV}$

Then after converting the values from the power meter to V_{rms} :

$$\text{response(dB)} = 20 \log_{10} \left[\frac{161.6 \text{ mV} / 185.3 \text{ mV}}{210.4 \text{ mV} / 211.2 \text{ mV}} \right] = -1.16 \text{ dB}$$

- 15** The result from step 14 should be between +3.0 dB and -3.0 dB. Record the result in the Performance Test Record (see [page 52](#)).
- 16** Move the power splitter from the channel 1 to the channel 2 input.
- 17** Turn off the current channel and turn on the next channel using the channel keys.
- 18** Repeat steps 3 through 17 for the remaining channels, setting the parameters of the channel being tested where appropriate.

To verify time base accuracy

This test verifies the accuracy of the time base. In this test you will measure the absolute error of the time base oscillator and compare the results to the specification.

Table 13 Equipment Required to Verify Time Base Accuracy

Equipment	Critical Specifications	Recommended Model/Part
Signal Generator	100 kHz - 1 GHz, 0.01 Hz frequency resolution, jitter: <2 ps	Keysight N5171B
50 Ω BNC Cable	BNC - BNC, 48" length	Keysight 8120-1840

- 1 Set up the signal generator.
 - a Set the output to 10 MHz, approximately 1 V_{pp} sine wave.
- 2 Connect the output of the signal generator to oscilloscope channel 1 using the BNC cable.
- 3 Set up the oscilloscope:
 - a Press [AutoScale].
 - b Set the oscilloscope Channel 1 vertical sensitivity to 200 mv/div.
 - c Set the oscilloscope horizontal sweep speed control to 5 ns/div.
 - d Adjust the intensity to get a sharp, clear trace.
 - e Adjust the oscilloscope's trigger level so that the rising edge of the waveform at the center of the screen is located where the center horizontal and vertical grid lines cross (center screen).
 - f Ensure the horizontal position control is set to 0.0 seconds.

- 4** Make the measurement.
- a** Set oscilloscope horizontal sweep speed control to 1 ms/div.
 - b** Set horizontal position control to +1 ms.
 - c** Set the oscilloscope horizontal sweep speed control to 5 ns/div.
 - d** Measure the number of nanoseconds from where the rising edge crosses the center horizontal grid line to the center vertical grid line. Each ns equals 1 ppm of time base error.

Time base accuracy limit: ± 1.6 ppm + aging

Aging factors:

- 1 year: ± 0.5 ppm
- 2 years: ± 0.7 ppm
- 5 years: ± 1.5 ppm
- 10 years: ± 2.0 ppm

Use the date code on the oscilloscope's serial tag to calculate the number of years since manufacture.

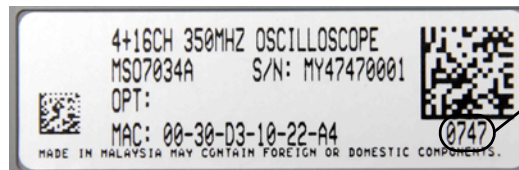

Date Code:
0747
07 = Year
47 = Week

- e** In the Performance Test Record (see [page 52](#)), record the time base error in ppm and whether it is within the specified limit.

To verify trigger sensitivity

This test verifies the trigger sensitivity. In this test, you will apply a sine wave to the oscilloscope at the upper bandwidth limit. You will then decrease the amplitude of the signal to the specified levels, and check to see if the oscilloscope is still triggered.

Test limits for:

- Internal trigger sensitivity on all models:
 - < 10 mV/div: greater of 1 div or 5 mV_{pp}
 - ≥ 10 mV/div: 0.6 div
- External trigger sensitivity on all models:
 - DC to 100 MHz: < 200 mV_{pp}
 - 100 MHz - 200 MHz: < 350 mV_{pp}

Table 14 Equipment Required to Verify Trigger Sensitivity

Equipment	Critical Specifications	Recommended Model/Part
Signal Generator	25 MHz, 100 MHz, 350 MHz, 500 MHz, and 1 GHz sine waves	Keysight N5171B
Power splitter	Outputs differ < 0.15 dB	Keysight 11667A
Power Meter		Keysight N1914A
Power Sensor		Keysight E9304A or N8482A
50 Ω BNC Cable (qty 3)	BNC - BNC, 48" length	Keysight 8120-1840
Adapter	N (m) to BNC (f), Qty 3	Keysight 1250-0780
Feedthrough	50 Ω BNC (f) to BNC (m)	Keysight 0960-0301

Test Internal Trigger Sensitivity (all models)

- 1 On the oscilloscope, press the **[Default Setup]** key.
- 2 Press the **[Mode/Coupling]** key; then, press the **Mode** softkey to select **Normal**.

- 3 Connect the equipment (see **Figure 8**).
 - a Connect the signal generator output to the oscilloscope channel 1 input.

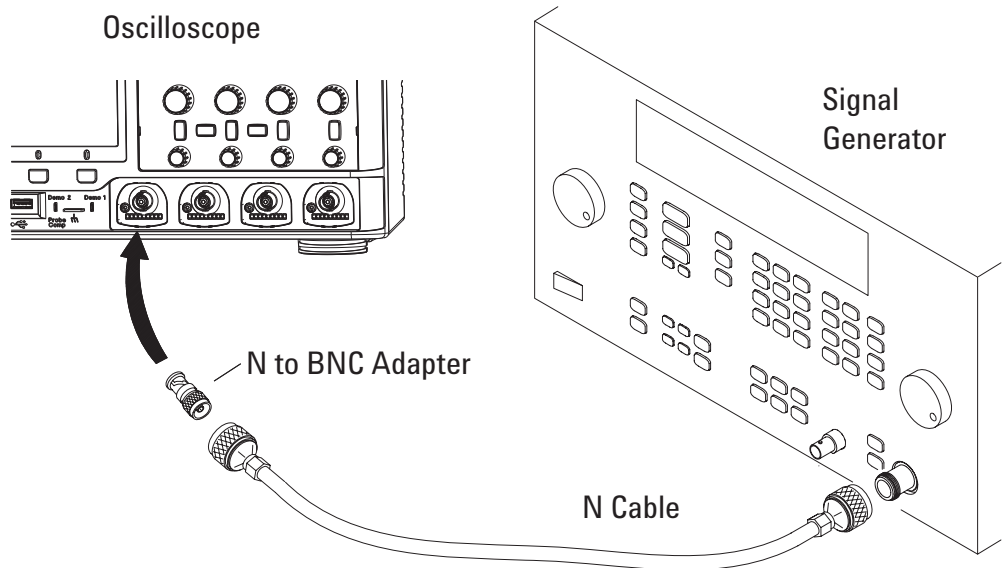

Figure 8 Setting Up Equipment for Internal Trigger Sensitivity Test

- b Set channel 1 **Imped** to **50 Ohm**.
- 4 To verify the trigger sensitivity at the oscilloscope's maximum bandwidth, set the output frequency of the signal generator to the maximum bandwidth of the oscilloscope:
 - 1 GHz models: 1 GHz.
 - 500 MHz models: 500 MHz.
 - 350 MHz models: 350 MHz.
 - 200 MHz models: 200 MHz.
 - 100 MHz models: 100 MHz.

5 Perform these steps to test at the 5 mV/div setting:

- a** Set the signal generator amplitude to about 10 mV_{pp}.
- b** Press the **[AutoScale]** key.
- c** Set the time base to 10 ns/div.
- d** Set channel 1 to 5 mV/div.
- e** Decrease the amplitude from the signal generator until 1 vertical division of the signal (about 5 mV_{pp}) is displayed.

The trigger is stable when the displayed waveform is stable. If the trigger is not stable, try adjusting the trigger level. If adjusting the trigger level makes the trigger stable, the test still passes. If adjusting the trigger does not help, see the “Troubleshooting” chapter. Then return here.

- f** Record the result as Pass or Fail in the Performance Test Record (see [page 52](#)).
- g** Repeat this step for the remaining oscilloscope channels.

6 Perform these steps to test at the 10 mV/div setting:

- a** Set the signal generator amplitude to about 20 mV_{pp}.
- b** Press the **[AutoScale]** key.
- c** Set the time base to 10 ns/div.
- d** Set channel 1 to 10 mV/div.
- e** Decrease the amplitude from the signal generator until 0.6 vertical divisions of the signal (about 6 mV_{pp}) is displayed.

The trigger is stable when the displayed waveform is stable. If the trigger is not stable, try adjusting the trigger level. If adjusting the trigger level makes the trigger stable, the test still passes. If adjusting the trigger does not help, see the “Troubleshooting” chapter. Then return here.

- f** Record the result as Pass or Fail in the Performance Test Record (see [page 52](#)).
- g** Repeat this step for the remaining oscilloscope channels.

Test External Trigger Sensitivity

This test applies to all models.

Verify the external trigger sensitivity at these settings:

- 100 MHz, 200 mV_{pp}
 - 200 MHz, 350 mV_{pp}
- 1** Connect the equipment (see **Figure 9**).
 - a** Use the N cable to connect the signal generator to the power splitter input.
 - b** Connect one output of the power splitter to the Aux Trig input through a 50 Ω feedthrough termination.
 - c** Connect the power sensor to the other output of the power splitter.

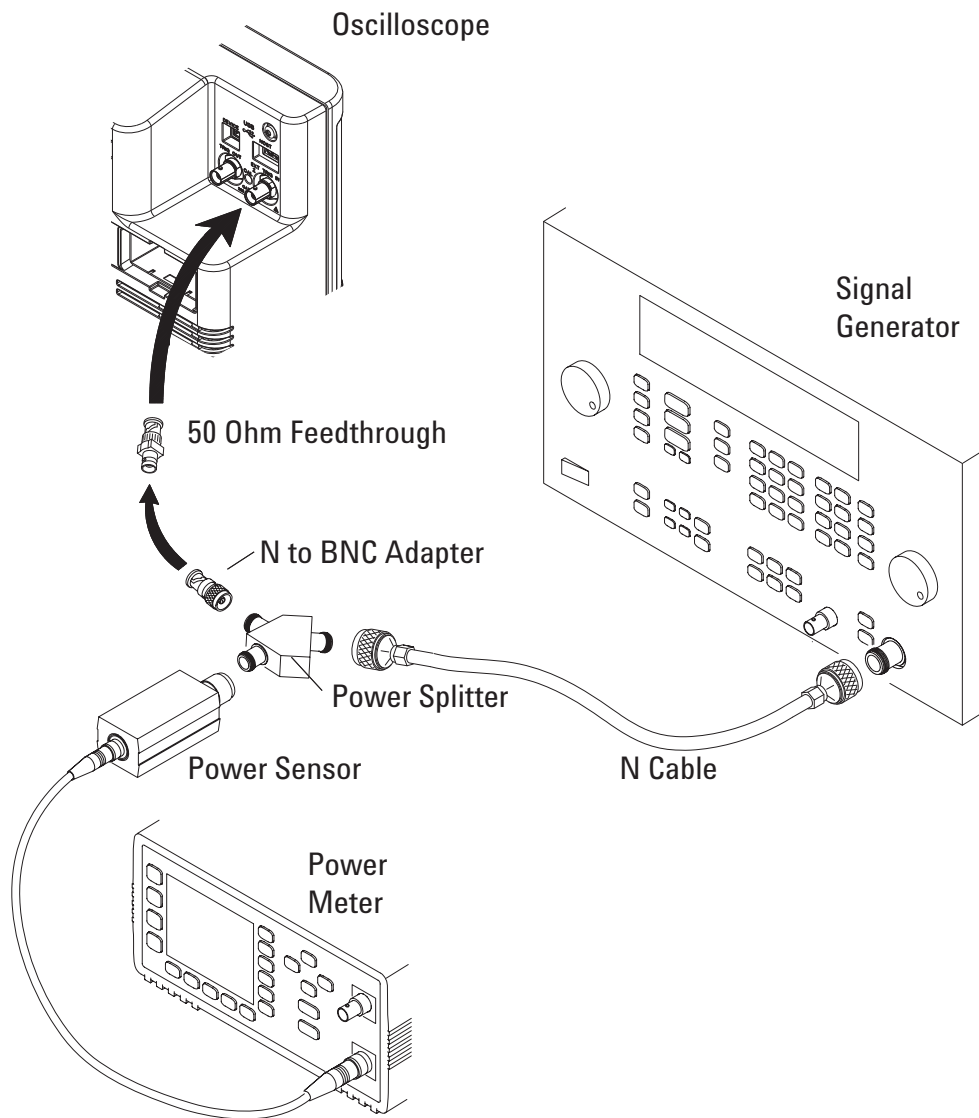

Figure 9 Setting Up Equipment for 4-Channel External Trigger Sensitivity Test

- 2 Set up the oscilloscope.
 - a Press the **[Default Setup]** key.
 - b Press the **[Mode/Coupling]** key; then, press the **Mode** softkey to select **Normal**.
- 3 Change the signal generator output frequency to 100 MHz or 200 MHz.
- 4 Set the power meter Cal Factor % to the appropriate value (100 MHz or 200 MHz) on the calibration chart on the power sensor. If necessary, do a linear interpolation if a 100 MHz or 200 MHz factor is not included in the power meter's calibration chart.
- 5 Adjust the signal generator output for reading on the power meter of:

Signal Generator Frequency	Calculation	Power Meter Reading
100 MHz	$200 \text{ mV}_{pp} = 70.71 \text{ mV rms, Power} = \text{Vin}^2/50\Omega = 70.71 \text{ mV}^2/50\Omega$	100 μW
200 MHz	$350 \text{ mV}_{pp} = 123.74 \text{ mV rms, Power} = \text{Vin}^2/50\Omega = 123.74 \text{ mV}^2/50\Omega$	306 μW

- 6 Press the **[Trigger]** key, then press the **Source** softkey to set the trigger source to **External**.
- 7 Check for stable triggering and adjust the trigger level if necessary. Triggering is indicated by the **Trig'd** indicator at the top of the display. When it is flashing, the oscilloscope is not triggered. When it is not flashing, the oscilloscope is triggered.
- 8 Record the results as Pass or Fail in the Performance Test Record (see [page 52](#)).

If the test fails, see the “Troubleshooting” chapter. Then return here.

Keysight 3000T X-Series Oscilloscopes Performance Test Record

Serial No. _____		Test by _____				
Test Interval _____		Work Order No. _____				
Recommended Next Testing _____		Temperature _____				
Threshold	Specification	Limits	Ch D7-D0	Ch D15-D8		
Accuracy Test	5 V - 250 mV	4.750 V	_____	_____		
(100 mV + 3% of threshold setting)	5 V + 250 mV	5.250 V	_____	_____		
	-5 V - 250 mV	-5.250 V	_____	_____		
	-5 V + 250 mV	-4.750 V	_____	_____		
	0 V - 100 mV	-100 mV	_____	_____		
	0 V + 100 mV	100 mV	_____	_____		
DC Vertical Gain Accuracy						
Range	Power Supply Setting	Test Limits	Channel 1	Channel 2	Channel 3*	Channel 4*
5 V/Div	35 V	34.2 V to 35.8 V	_____	_____	_____	_____
2 V/Div	14 V	13.68 V to 14.32 V	_____	_____	_____	_____
1 V/Div	7 V	6.84 V to 7.16 V	_____	_____	_____	_____
500 mV/Div	3.5 V	3.42 V to 3.58 V	_____	_____	_____	_____
200 mV/Div	1.4 V	1.368 V to 1.432 V	_____	_____	_____	_____
100 mV/Div	700 mV	684 mV to 716 mV	_____	_____	_____	_____
50 mV/Div	350 mV	342 mV to 358 mV	_____	_____	_____	_____
20 mV/Div	140 mV	136.8 mV to 143.2 mV	_____	_____	_____	_____
10 mV/Div	70 mV	68.4 mV to 71.6 mV	_____	_____	_____	_____
5 mV/Div	35 mV	34.2 mV to 35.8 mV	_____	_____	_____	_____
2 mV/Div	14 mV	13.36 mV to 14.64 mV	_____	_____	_____	_____
1 mV/Div	7 mV	6.36 mV to 7.64 mV	_____	_____	_____	_____

Continued on next page.

Dual Cursor Accuracy						
Range	Power Supply Setting	Test Limits	Channel 1	Channel 2	Channel 3*	Channel 4*
5 V/Div	35 V	34.0 V to 36.0 V	_____	_____	_____	_____
2 V/Div	14 V	13.6 V to 14.4 V	_____	_____	_____	_____
1 V/Div	7 V	6.8 V to 7.2 V	_____	_____	_____	_____
500 mV/Div	3.5 V	3.4 V to 3.6 V	_____	_____	_____	_____
200 mV/Div	1.4 V	1.36 V to 1.44 V	_____	_____	_____	_____
100 mV/Div	700 mV	680 mV to 720 mV	_____	_____	_____	_____
50 mV/Div	350 mV	340 mV to 360 mV	_____	_____	_____	_____
20 mV/Div	140 mV	136 mV to 144 mV	_____	_____	_____	_____
10 mV/Div	70 mV	68 mV to 72 mV	_____	_____	_____	_____
5 mV/Div	35 mV	34 mV to 36 mV	_____	_____	_____	_____
2 mV/Div	14 mV	13.2 mV to 14.8 mV	_____	_____	_____	_____
1 mV/Div	7 mV	6.2 mV to 7.8 mV	_____	_____	_____	_____
Bandwidth (-3 dB)						
Model	Test Limits	Channel 1	Channel 2	Channel 3*	Channel 4*	
310x	-3 dB at 1 GHz	_____	_____	_____	_____	
305x	-3 dB at 500 MHz	_____	_____	_____	_____	
303x	-3 dB at 350 MHz	_____	_____	_____	_____	
302x	-3 dB at 200 MHz	_____	_____	_____	_____	
301x	-3 dB at 100 MHz	_____	_____	_____	_____	
Time Base Accuracy Limits			Calculated time base accuracy limit (ppm)	Measured time base error (ppm)	Pass/Fail	
Time Base Accuracy Limit: ± 1.6 ppm + aging			_____	_____	_____	
Internal Trigger Sensitivity						
	Generator Setting	Test Limits	Channel 1	Channel 2	Channel 3*	Channel 4*
1 GHz models:	1 GHz	< 10 mV/div: greater of 1 div or 5 mVpp	_____	_____	_____	_____
500 MHz models:	350 MHz		_____	_____	_____	_____
350 MHz models:	200 MHz	>= 10 mV/div: 0.6 div	_____	_____	_____	_____
200 MHz models:	100 MHz		_____	_____	_____	_____
100 MHz models:			_____	_____	_____	_____
External Trigger Sensitivity						
	Generator Setting	Test Limits	Ext Trig In			
	200 MHz	350 mV	_____			
	100 MHz	200 mV	_____			
* Where applicable						

2 Testing Performance

3 Calibrating and Adjusting

This chapter explains how to adjust the oscilloscope for optimum operating performance. You should perform self-calibration according to the following recommendations:

- Every three years or after 6000 hours of operation
- If the ambient temperature is >10 °C from the calibration temperature
- If you want to maximize the measurement accuracy

The amount of use, environmental conditions, and experience with other instruments help determine if you need shorter adjustment intervals.

Let the Equipment Warm Up Before Adjusting

Before you start the adjustments, let the oscilloscope and test equipment warm up for at least 30 minutes.

Read All Cautions and Warnings

Read the following cautions and warning before making adjustments or performing self-calibration.

WARNING

HAZARDOUS VOLTAGES!

Read the safety notice at the front of this book before proceeding. Maintenance is performed with power supplied to the oscilloscope and with the protective covers removed. Only trained service personnel who are aware of the hazards involved should perform the maintenance. Whenever possible, perform the procedures with the power cord removed from the oscilloscope.

CAUTION

REMOVE POWER TO AVOID DAMAGE!

Do not disconnect any cables or remove any assemblies with power applied to the oscilloscope. Otherwise, damage to the oscilloscope can occur.

CAUTION

USE EXTERNAL FAN TO REDUCE TEMPERATURE!

When you must operate the oscilloscope with its cover and main shield removed, use an external fan to provide continuous air flow over the samplers (the ICs with heat sinks on them). Air flow over the samplers is reduced when the cover and main shield is removed, which leads to higher than normal operating temperatures. Have the fan blow air across the system board where the heat sinks are located. If the cover is removed but the main shield remains installed and the bottom holes are not blocked, the instrument will cool properly.

CAUTION

AVOID DAMAGE TO ELECTRONIC COMPONENTS!

Electrostatic discharge (ESD) can damage electronic components. When you use any of the procedures in this chapter, use proper ESD precautions. As a minimum, place the oscilloscope on a properly grounded ESD mat and wear a properly grounded ESD strap.

User Calibration

Perform user-calibration:

- Every three years or after 6000 hours of operation.
- If the ambient temperature is $>10^{\circ}\text{C}$ from the calibration temperature.
- If you want to maximize the measurement accuracy.

The amount of use, environmental conditions, and experience with other instruments help determine if you need shorter User Cal intervals.

User Cal performs an internal self-alignment routine to optimize the signal path in the oscilloscope. The routine uses internally generated signals to optimize circuits that affect channel sensitivity, offset, and trigger parameters. Disconnect all inputs and allow the oscilloscope to warm up before performing this procedure.

Performing User Cal will invalidate your Certificate of Calibration. If NIST (National Institute of Standards and Technology) traceability is required perform the procedures in **Chapter 2** in this book using traceable sources.

To perform User Cal

- 1** Disconnect all inputs from the front and rear panels, including the digital channels cable on an MSO, and allow the oscilloscope to warm up before performing this procedure.
- 2** Press the rear-panel CAL button to disable calibration protection..
- 3** Connect short (12 inch maximum) equal length cables to each analog channel's BNC connector on the front of the oscilloscope. You will need two equal-length cables for a 2-channel oscilloscope or four equal-length cables for a 4-channel oscilloscope.

3 Calibrating and Adjusting

Use 50 Ω RG58AU or equivalent BNC cables when performing User Cal.

- a For a 2-channel oscilloscope, connect a BNC tee to the equal length cables. Then connect a BNC(f)-to-BNC(f) (also called a barrel connector) to the tee as shown below.

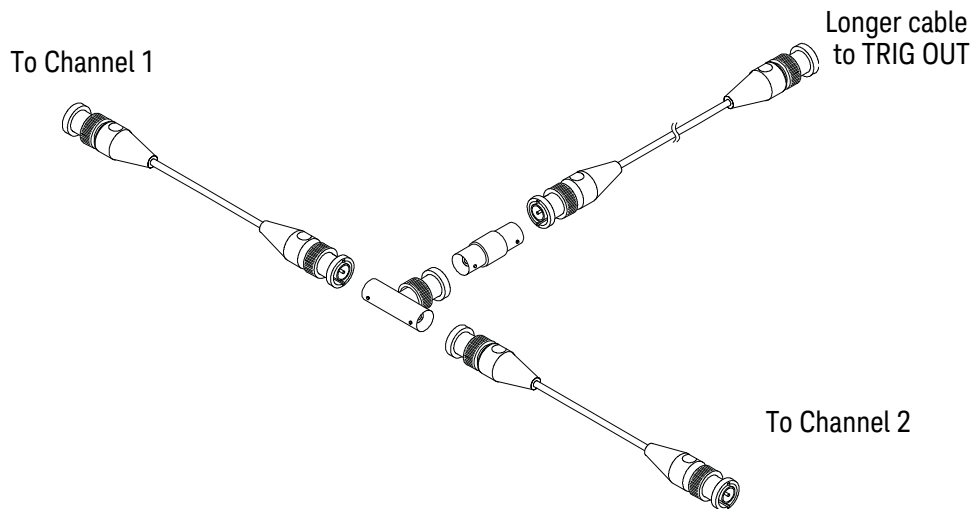
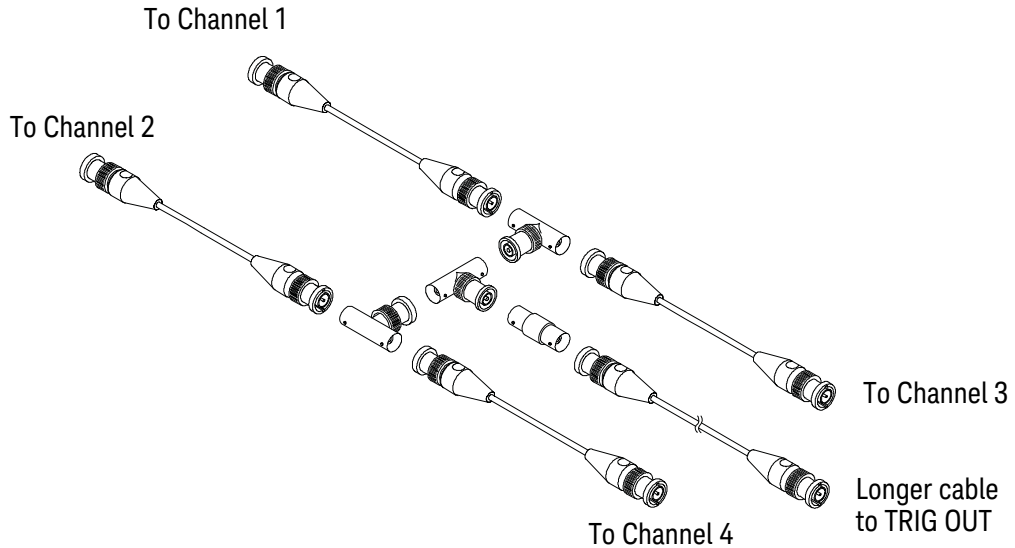

Figure 10 User Calibration cable for 2-channel oscilloscope

- b** For a 4-channel oscilloscope, connect BNC tees to the equal-length cables as shown below. Then connect a BNC(f)-to-BNC(f) (barrel connector) to the tee as shown below.

**Figure 11** User Calibration cable for 4-channel oscilloscope

- 4** Connect a BNC cable (40 inches maximum) from the TRIG OUT connector on the rear panel to the BNC barrel connector.
- 5** Press the **[Utility]** key; then, press the **Service** softkey.
- 6** Begin the Self Cal by pressing the **Start User Cal** softkey.

User Cal Status

Pressing the **User Cal Status** softkey displays the following summary results of the previous User Cal, and the status of probe calibrations for probes that can be calibrated. Note that AutoProbes do not need to be calibrated, but InfiniiMax probes can be calibrated.

```
Results:  
User Cal date:  
Change in temperature since last User Cal:  
Failure:  
Comments:  
Probe Cal Status:
```

4 Troubleshooting

Solving General Problems with the Oscilloscope / 62

Verifying Basic Operation / 65

Troubleshooting Internal Assemblies / 70

Read All Cautions and Warnings

Before you begin any troubleshooting, read all Warning and Cautions in the “Troubleshooting” section.

This chapter begins with **“Solving General Problems with the Oscilloscope”**. It tells you what to do in these cases:

- **If there is no display.**
- **If there is no trace display.**
- **If the trace display is unusual or unexpected.**
- **If you cannot see a channel.**

Next, this chapter describes procedures for **“Verifying Basic Operation”** of the oscilloscope:

- **To power-on the oscilloscope.**
- **To perform hardware self test.**
- **To perform front panel self test.**
- **To verify default setup.**
- **To perform an Auto Scale on the Probe Comp signal.**
- **To compensate passive probes.**

Finally, this chapter describes procedures for **“Troubleshooting Internal Assemblies** when performing assembly-level repair:

- **To prepare for internal assembly troubleshooting.**
- **To check the system board power supply test points.**
- **To check the interboard supply connector voltages.**
- **To check the line filter board AC output.**
- **To check the power switch.**
- **To check the power supply DC output.**
- **To check the display supplies.**
- **To check the keyboard supplies.**
- **To check the fan.**

Solving General Problems with the Oscilloscope

This section describes how to solve general problems that you may encounter while using the Keysight 3000T X-Series oscilloscopes.

After troubleshooting the oscilloscope, if you need to replace parts, refer to **Chapter 6**, “Replaceable Parts,” starting on page 131.

If there is no display

- ✓ Check that the power cord is firmly seated in the oscilloscope power receptacle.
- ✓ Check that the power source is live.
- ✓ Check that the front-panel power switch is on.
- ✓ If there is still no display, go to the troubleshooting procedures in this chapter.

If there is no trace display

- ✓ Check that the Intensity (on the front panel) is adjusted correctly.
- ✓ Recall the default setup by pressing [**Default Setup**]. This will ensure that the trigger mode is Auto.
- ✓ Check that the probe clips are securely connected to points in the circuit under test, and that the ground is connected.
- ✓ Check that the circuit under test is powered on.
- ✓ Press the [**AutoScale**] key.
- ✓ Obtain service from Keysight Technologies, if necessary.

If the trace display is unusual or unexpected

- ✓ Check that the Horizontal time/division setting is correct for the expected frequency range of the input signals.
- ✓ The sampling speed of the oscilloscope depends on the time/division setting. It may be that when time/division is set to slower speeds, the oscilloscope is sampling too slowly to capture all of the transitions on the waveform. Use peak detect mode.
- ✓ Check that all oscilloscope probes are connected to the correct signals in the circuit under test.
- ✓ Ensure that the probe's ground lead is securely connected to a ground point in the circuit under test. For high-speed measurements, each probe's individual ground lead should also be connected to a ground point closest to the signal point in the circuit under test.
- ✓ Check that the trigger setup is correct.
- ✓ A correct trigger setup is the most important factor in helping you capture the data you desire. See the *User's Guide* for information about triggering.
- ✓ Check that persistence in the Display menu is turned off, then press the **Clear Display** softkey.
- ✓ Press the [**Auto Scale**] key.

If you cannot see a channel

- ✓ Recall the default setup by pressing **[Default Setup]**. This will ensure that the trigger mode is Auto.
- ✓ Check that the oscilloscope probe's BNC connector is securely attached to the oscilloscope's input connector.
- ✓ Check that the probe clips are securely connected to points in the circuit under test.
- ✓ Check that the circuit under test is powered on.

You may have pressed the **[Auto Scale]** key before an input signal was available.

Performing the checks listed here ensures that the signals from the circuit under test will be seen by the oscilloscope. Perform the remaining checks in this topic to make sure the oscilloscope channels are on, and to obtain an automatic setup.

- ✓ Check that the desired oscilloscope channels are turned on.
 - a** Press the analog channel key until it is illuminated.
 - b** On models with the MSO option, press the digital channels **[Digital]** key until it is illuminated.
- ✓ Press the **[Auto Scale]** key to automatically set up all channels.

Verifying Basic Operation

To power-on the oscilloscope

- 1 Connect the power cord to the rear of the oscilloscope, then to a suitable ac voltage source.

The oscilloscope power supply automatically adjusts for input line voltages in the range of 100 to 240 VAC. Ensure that you have the correct line cord (see [page 131](#)). The power cord provided is matched to the country of origin.

WARNING

AVOID INJURY.

Always operate the oscilloscope with an approved three conductor power cable. Do not negate the protective action of the three conductor power cable.

-
- Press the power switch.
 - When the oscilloscope is turned on, the front panel LEDs will briefly light up in groups from bottom to top.
 - Next the Keysight logo appears on the display.
 - Next a message will appear with tips on getting started using the oscilloscope. At this time you can press any key to remove the message and view the display. Or you can wait and the message will automatically disappear.
 - It will take a total of about 20-30 seconds for the oscilloscope to go through its basic self test and power-up routine.
- 2 Proceed to **"To perform hardware self test"** on page 65.

To perform hardware self test

Pressing **[Utility] > Service > Hardware Self Test** performs a series of internal procedures to verify that the oscilloscope is operating properly.

It is recommended you run Hardware Self Test:

- After experiencing abnormal operation.
- For additional information to better describe an oscilloscope failure.
- To verify proper operation after the oscilloscope has been repaired.

Successfully passing Hardware Self Test does not guarantee 100% of the oscilloscope's functionality. Hardware Self Test is designed to provide an 80% confidence level that the oscilloscope is operating properly.

To perform front panel self test

Pressing **[Utility] > Service > Front Panel Self Test** lets you test the front panel keys and knobs as well as the oscilloscope display.

Follow the on-screen instructions.

Failures in the front panel self test indicate problems with the keyboard, keypad, or display.

To verify default setup

The oscilloscope is designed to turn on with the setup from the last turn on or previous setup.

To recall the default setup:

- 1 Press the **[Default Setup]** key.

This returns the oscilloscope to its default settings and places the oscilloscope in a known operating condition. The major default settings are:

- **Horizontal:**
 - main mode.
 - 100 us/div scale.
 - 0 s delay.
 - center time reference.
- **Vertical:**
 - Channel 1 on.
 - 5 V/div scale.
 - dc coupling.
 - 0 V position.
 - probe factor to 1.0 if an AutoProbe probe is not connected to the channel.
- **Trigger:**
 - Edge trigger.
 - Auto sweep mode.

- 0 V level.
- channel 1 source.
- dc coupling.
- rising edge slope.
- 40 ns holdoff time.
- **Display:**
 - 20% grid intensity.
 - persistence off.
- **Other:**
 - Acquire mode normal.
 - Run/Stop to Run.
 - cursor measurements off.

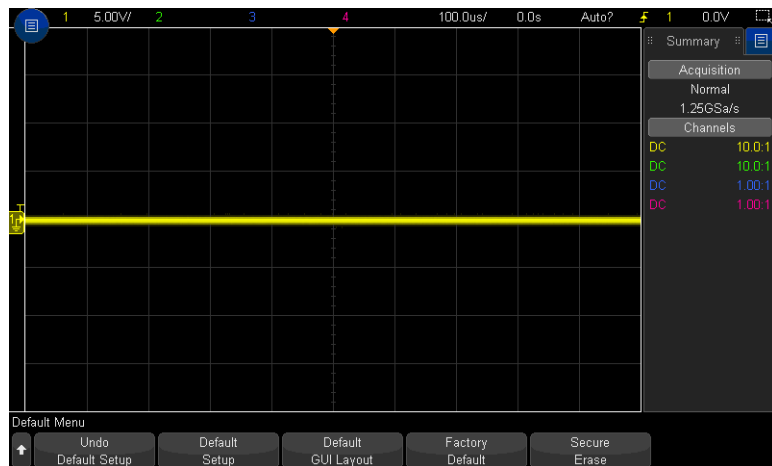
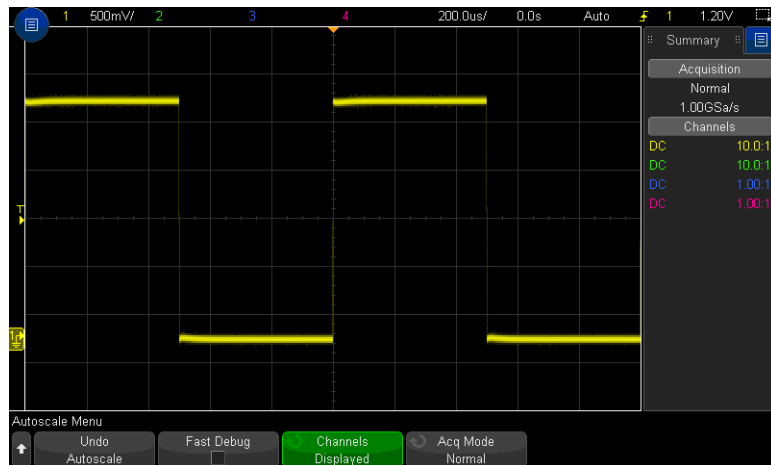

Figure 12 Default setup screen

2 If your screen looks substantially different, replace the system board.

To perform an Auto Scale on the Probe Comp signal

- 1 Press the **[Default Setup]** key. The oscilloscope is now configured to its default settings.
- 2 Connect an oscilloscope probe from channel 1 to the **Probe Comp** signal terminal on the front panel.
- 3 Connect the probe's ground lead to the ground terminal that is next to the **Demo 2** (Probe Comp) terminal.
- 4 Press **[AutoScale]**.
- 5 You should see a waveform on the oscilloscope's display similar to this:



If you see the waveform, but the square wave is not shaped correctly as shown above, perform the procedure **“To compensate passive probes”** on page 69.

If you do not see the waveform, ensure your power source is adequate, the oscilloscope is properly powered-on, and the probe is connected securely to the front-panel analog channel input BNC and to the Demo 2 (Probe Comp) terminal.

- 6 If you still do not see the waveform, use the troubleshooting flowchart in this chapter to isolate the problem.

To compensate passive probes

You should compensate your passive probes to match their characteristics to the oscilloscope's channels. A poorly compensated probe can introduce measurement errors.

- 1 Perform the procedure **"To perform an Auto Scale on the Probe Comp signal"** on page 68
- 2 Press the channel key to which the probe is connected (**[1]**, **[2]**, etc.).
- 3 In the Channel Menu, press **Probe**.
- 4 In the Channel Probe Menu, press **Probe Check**; then, follow the instructions on-screen.

If necessary, use a nonmetallic tool (supplied with the probe) to adjust the trimmer capacitor on the probe for the flattest pulse possible.

On the N2862/63/90 probes, the trimmer capacitor is the yellow adjustment on the probe tip. On other probes, the trimmer capacitor is located on the probe BNC connector.

Perfectly compensated

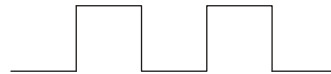

Over compensated



Under compensated



comp.cdr

Figure 13 Example pulses

- 5 Connect probes to all other oscilloscope channels (channel 2 of a 2-channel oscilloscope, or channels 2, 3, and 4 of a 4-channel oscilloscope).
- 6 Repeat the procedure for each channel.

The process of compensating the probes serves as a basic test to verify that the oscilloscope is functional.

Troubleshooting Internal Assemblies

The service policy for all bandwidth model oscilloscopes is assembly level replacement. You can use the procedures described in this section to help identify assemblies that need replacement.

Generally, you want to make sure cables to the assembly are good and properly seated. Then, you check that the assembly is supplied with the proper power. If cables are good and the power is good, but the assembly still does not function properly, it must be replaced.

If you need parts or assistance from Keysight Technologies to repair your instrument, go to www.keysight.com and locate the service facility for your area.

Equipment Required for Troubleshooting Internal Assemblies

The equipment listed in this table is required to troubleshoot the oscilloscope.

Table 15 Equipment Required to Troubleshoot the Oscilloscope

Equipment	Critical Specifications	Recommended Model/Part
Digital multimeter	Accuracy $\pm 0.05\%$ 1 mV resolution	Keysight 34401A/34461A
Oscilloscope	Capable of measuring ≥ 500 MHz signal. 1 M Ω input impedance.	Keysight DSO6102A, MSO6102A, DSO7104A/B, or MSO7104A/B

To prepare for internal assembly troubleshooting

WARNING

HAZARDOUS VOLTAGES EXIST – REMOVE POWER FIRST !

The procedures described in this section are performed with power supplied to the oscilloscope and with the protective covers removed. Only trained service personnel who are aware of the hazards involved should perform the procedures. Whenever possible, perform the procedures with the power cord removed from the oscilloscope. Read the safety notice at the back of this book before proceeding.

WARNING



HAZARDOUS VOLTAGES EXIST – HIGH VOLTAGE IS PRESENT ON POWER SUPPLY HEAT SINKS !

The power supply heat sinks of the 3000T X-Series oscilloscopes are at a high potential. This presents an electric shock hazard. Protect yourself from electric shock by keeping this area covered or by not coming in contact with the heat sinks when the power cord is attached to the oscilloscope!

CAUTION**REMOVE POWER TO AVOID DAMAGE !**

Do not disconnect any cables or remove any assemblies while power is applied to the oscilloscope, or damage to the oscilloscope can occur.

CAUTION**AVOID ESD DAMAGE TO COMPONENTS !**

ELECTROSTATIC DISCHARGE (ESD) can damage electronic components. Use proper ESD precautions when doing any of the procedures in this chapter. As a minimum, place the oscilloscope on a properly grounded ESD mat and wear a properly grounded ESD strap.

- 1 Disconnect any external cables from the front panel.
- 2 Disconnect the power cord.
- 3 Remove the bucket assembly following the instructions on [page 90](#).
- 4 Remove the power supply shield following the instructions on [page 92](#).
- 5 Separate the front and rear decks following the instructions on [page 95](#).
- 6 Re-connect the interboard supply cable as shown in the following figure.

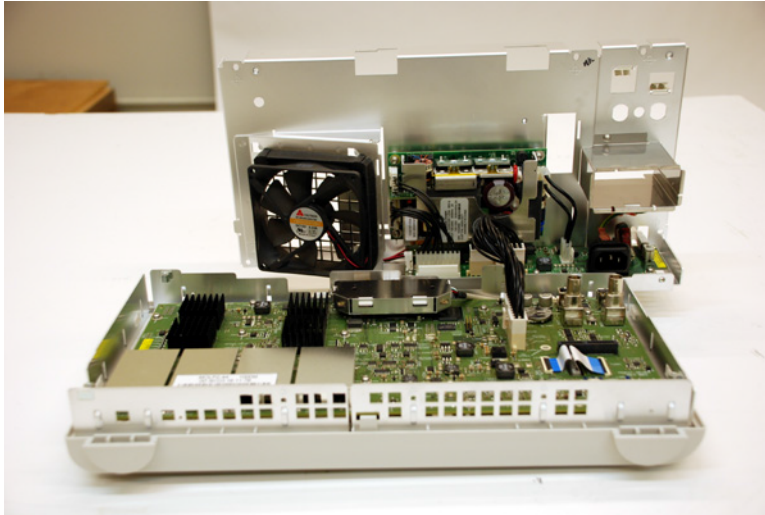

Figure 14 Setup for troubleshooting internal assemblies

CAUTION

MAKE SURE EARTH GROUND IS MAINTAINED FOR THE FRONT DECK !

For example, connect a cable with alligator clips between the rear deck chassis and the front deck chassis, or connect a BNC cable from one of the BNCs on the system board to a known grounded BNC on your workbench.

Other advice:

- Place the front deck in a cover or rest it on a cloth to prevent scuffing the front panel knobs.
 - Because of the short length of the interboard supply cable, elevate the rear deck to prevent strain on the cable.
- 7** Make sure the keyboard cable, display cable, display backlight power cable, and all other cables are properly connected.

CAUTION

USE AN EXTERNAL FAN TO AVOID OVERHEATING COMPONENTS !

When you remove the oscilloscope cover and main shield, use an external fan to provide continuous air flow over the heat sinks. Air flow over the heat sinks is reduced when the cover and main shield are removed, which leads to higher than normal operating temperatures. Have the fan blow air across the system board where the heat sinks are located. Otherwise, damage to the components can occur. If the cover of a 3000T X-Series oscilloscope is removed but the main shield remains installed and the bottom holes are not blocked, the instrument will cool properly.

Flowchart for Troubleshooting Internal Assemblies

The following flowchart is a simplified overview of troubleshooting the oscilloscope's internal assemblies.

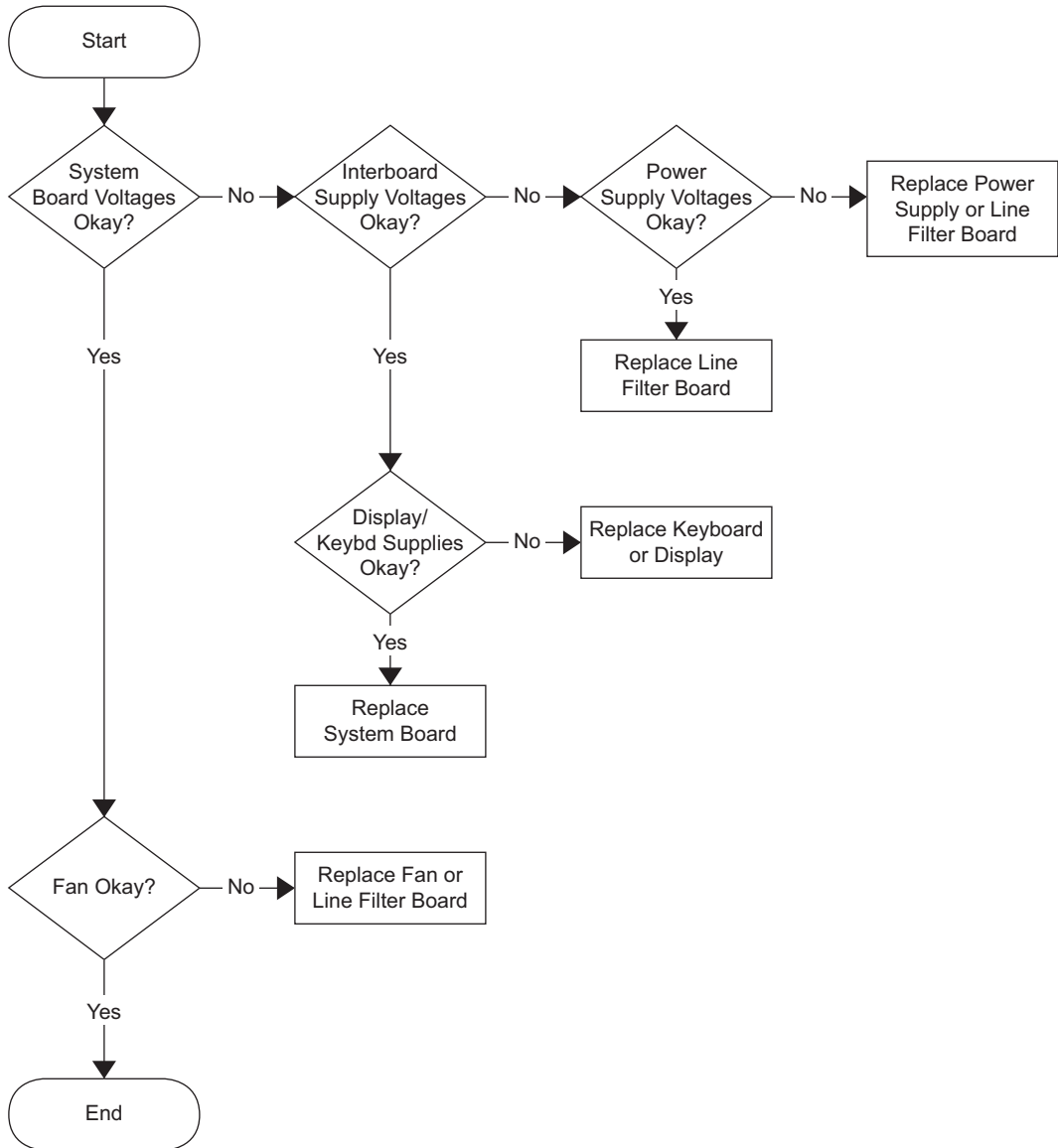

System Board Drawings

Use these drawings to locate test points on the system board.

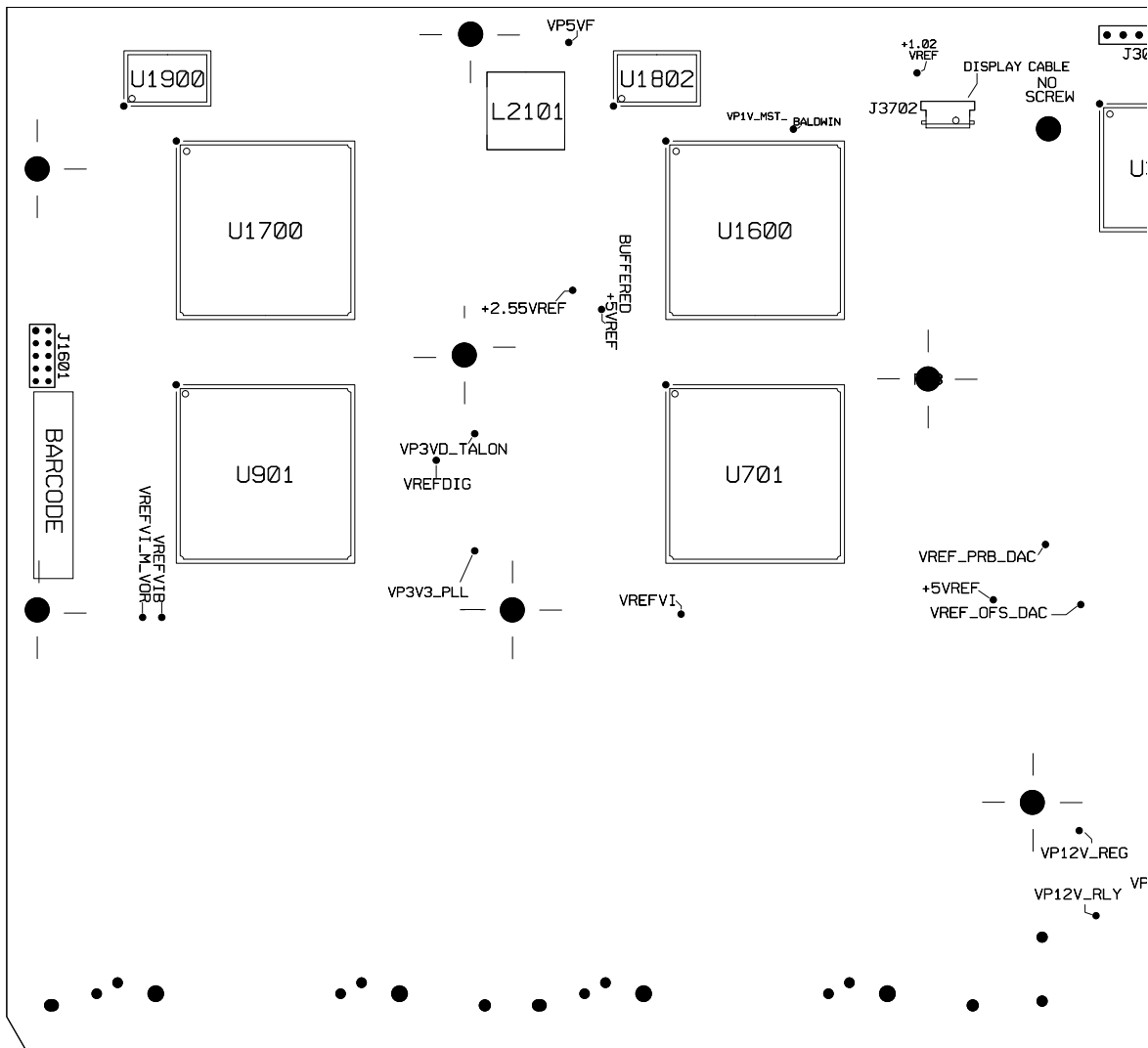

Figure 15 System Board Test Points/Connectors - Top Side, Left

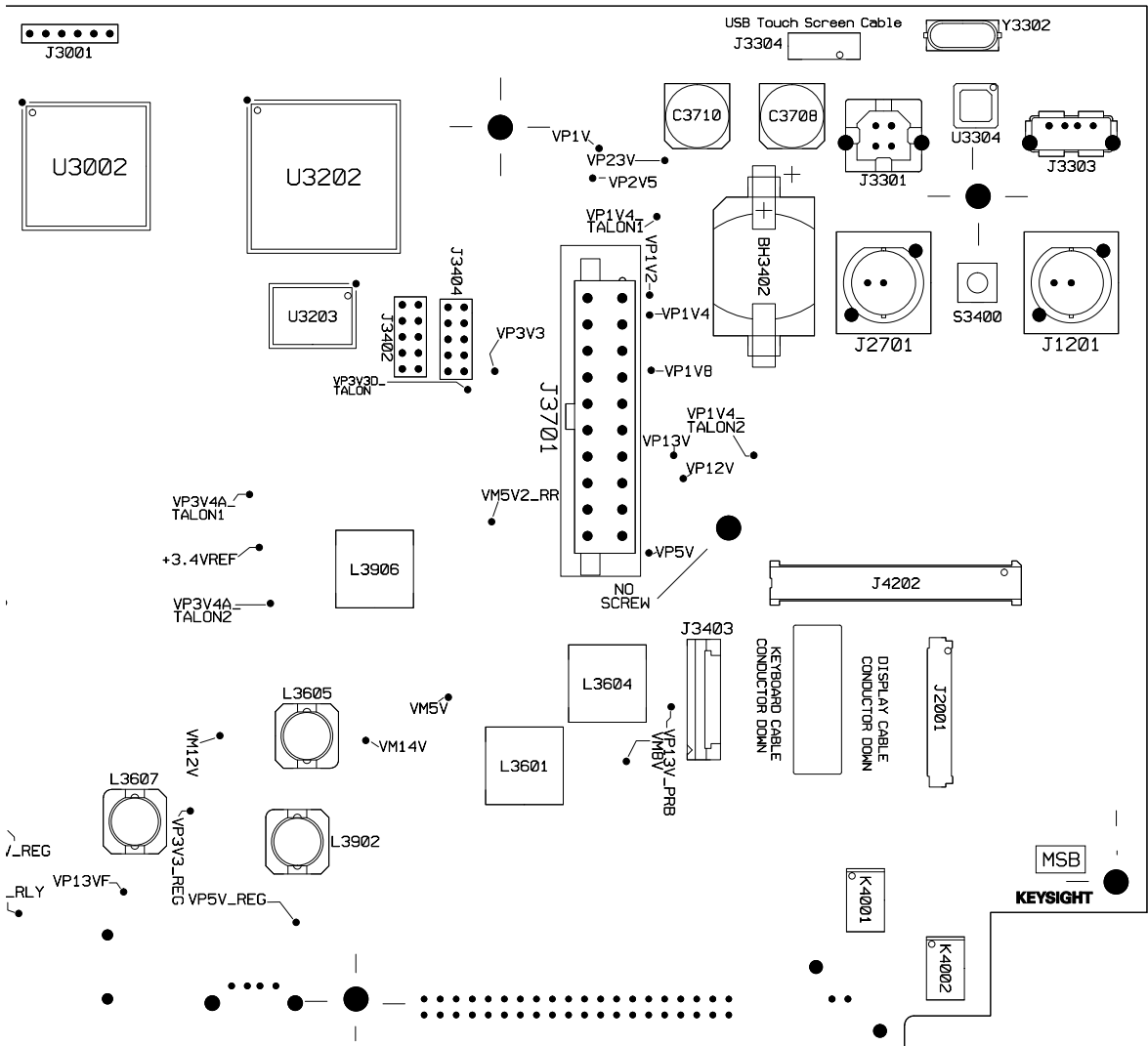

Figure 16 System Board Test Points/Connectors - Top Side, Right

To check the system board power supply test points

This procedure checks the power supply test points on the system board (see See **Figure 16** on page 75). Values outside the expected range help identify bad assemblies.

- 1 Follow the instructions in **"To prepare for internal assembly troubleshooting"** on page 70.
- 2 Connect the negative lead of the multimeter to a ground point on the oscilloscope.
- 3 Connect the power cord, and turn on the oscilloscope.
- 4 First check the bulk power supply voltage:

Test Point (near J3701)	Expected Value	Assemblies Supplied	If Good	If Bad
VP13V	+13 V \pm 3%	All	Indicates power supply is good.	Go to "To check the interboard supply connector voltages" on page 77 and check VP13V there.

- 5 Next, check the supplies coming from the line filter board:

Test Point (near J3701)	Expected Value	Assemblies Supplied	If Good	If Bad
VP5V	+5 V \pm 3%	Keyboard, System Board	Indicates supply coming from line filter board is good.	Go to "To check the interboard supply connector voltages" on page 77.
VP12V	+12 V \pm 3%	System Board		
VP1V8	+1.8 V \pm 3%	System Board		
VP1V4	+1.4 V \pm 3%	System Board		
VP1V	+1 V \pm 3%	System Board		
VP1V2	+1.2 V \pm 3%	System Board		
VP2V5	+2.5 V \pm 3%	System Board		
VP3V3	+3.3 V \pm 3%	LCD, System Board		

6 Finally, check the supplies coming from the system board:

Test Point (near J3701)	Expected Value	Assemblies Supplied	If Good	If Bad
VM12V	-11.5 V to -12.5 V	System Board	Indicates supply coming from system board is good.	Replace the system board.
VM8V	-7.814 V to -8.333 V	System Board		Replace the system board.
VM5V2	-5.023 V to -5.329 V	System Board		Replace the system board.
VP13VF	+13 V \pm 3%	System Board		Replace the system board.
VP23V	+22.84 V to +24.2 V	Display Backlight Power		Go to "To check the display supplies" on page 82.
VP13V_PRB	+13 V \pm 3%	AutoProbe Interface		Go to "To check the keyboard supplies" on page 83.

To check the interboard supply connector voltages

This procedure checks the voltages on the line filter board's interboard supply connector (J108) when the interboard supply cable is disconnected.

If these voltages are bad when the cable is connected but good when the cable is disconnected, it indicates problems with the system board, keyboard, or display assemblies that are being supplied.

- 1** Follow the instructions in **"To prepare for internal assembly troubleshooting"** on page 70.
- 2** Connect the negative lead of the multimeter to a ground point on the oscilloscope.
- 3** With the power cord disconnected, disconnect the interboard supply cable from the system board and the line filter board.
- 4** Connect the power cord, and turn on the oscilloscope.

- 5 Check the voltages on the line filter board's interboard supply connector J108.

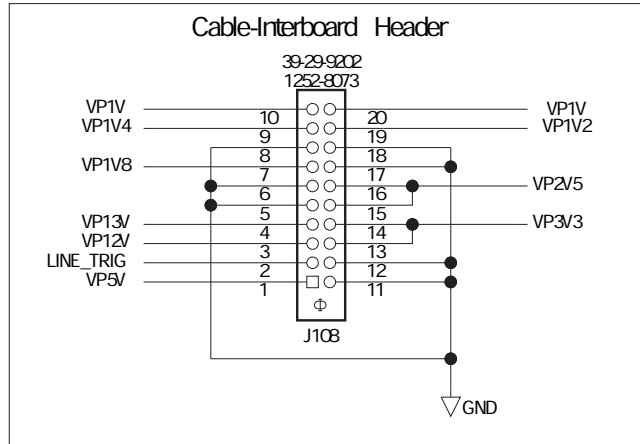

Figure 17 Line filter board interboard supply connector J108

- a If the VP13V bulk supply was bad at the system board test point, check it again at the interboard supply connector J108:

Test Point (near J3701)	Expected Value	Assemblies Supplied	If Good	If Bad
VP13V	+13 V ±3%	Whole system	<p>If good when the interboard supply cable is disconnected from the system board, but bad when the interboard supply cable is connected, this indicates a problem with either the cable or the assemblies supplied,</p> <ol style="list-style-type: none"> 1 First, test the interboard supply cable for opens or shorts using the DMM. 2 If the interboard supply cable is good, replace the system board. 	Go to "To check the line filter board AC output" on page 79 to test whether the AC input to the power supply is good.

- b If the VP13V bulk supply was good at the system board test point, but other supplies coming from the line filter board were bad at the system board test points, check them again at the interboard supply connector J108:

Test Point (near J3701)	Expected Value	Assemblies Supplied	If Good	If Bad
VP5V	+5 V \pm 3%	Keyboard, System Board	Go to "To check the keyboard supplies" on page 83.	Replace the line filter board.
VP12V	+12 V \pm 3%	System Board	If good when the interboard supply cable is disconnected from the system board, but bad when the interboard supply cable is connected, this indicates a problem with either the cable or the assemblies supplied, 1 First, test the interboard supply cable for opens or shorts using the DMM. 2 If the interboard supply cable is good, replace the system board.	Replace the line filter board.
VP1V8	+1.8 V \pm 3%	System Board		Replace the line filter board.
VP1V4	+1.4 V \pm 3%	System Board		Replace the line filter board.
VP1V	+1 V \pm 3%	System Board		Replace the line filter board.
VP1V2	+1.2 V \pm 3%	System Board		Replace the line filter board.
VP2V5	+2.5 V \pm 3%	System Board		Replace the line filter board.
VP3V3	+3.3 V \pm 3%	LCD, System Board	Go to "To check the display supplies" on page 82.	Replace the line filter board.

To check the line filter board AC output

When the 13 V bulk power is not being properly supplied, this procedure tests the AC input to the power supply to determine whether there is a problem with the line filter board.

- 1** Follow the instructions in **"To prepare for internal assembly troubleshooting"** on page 70.
- 2** Connect the power cord, and turn on the oscilloscope.
- 3** Verify that AC power is present at J1 on the power supply using a DVM and probes as shown in the following picture (remember this is an AC voltage measurement!).

Verify AC potential between these two points

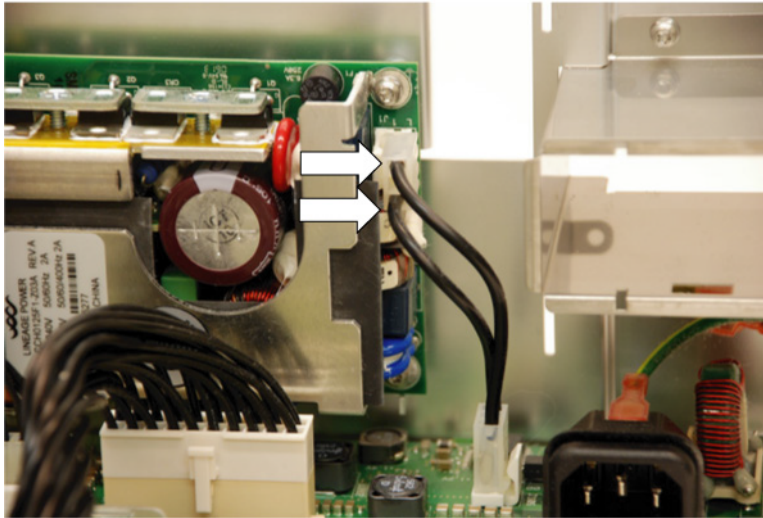

Figure 18 Verify line filter board AC output

- If you have AC power equal to what is being applied to J100 (power cord socket) on the line filter assembly, the AC mains portion of the line filter assembly is probably okay.
- If there is no AC power at J1 of the power supply, there is something wrong with the AC mains section of the line filter assembly, and you need to *replace the line filter assembly*.
- If there is AC power at J1 of the power supply, but the instrument still will not power ON when the power switch (S100) is in the ON position, go to **“To check the power switch”** on page 80.

To check the power switch

This procedure verifies the operation of the power switch (S100) on the line filter board assembly.

- 1 Follow the instructions in **“To prepare for internal assembly troubleshooting”** on page 70.

- 2 With the power cord disconnected, verify the operation of the power switch (S100) using a DMM in the resistance measurement mode and a set of probes.
 - a Connect the “-” side of the DMM to pin 6 of J107 on the line filter board and the “+” side of the DMM to pin 6 of J6 on the power supply.

**Verify ON/OFF switch (S100)
operation between these two points**

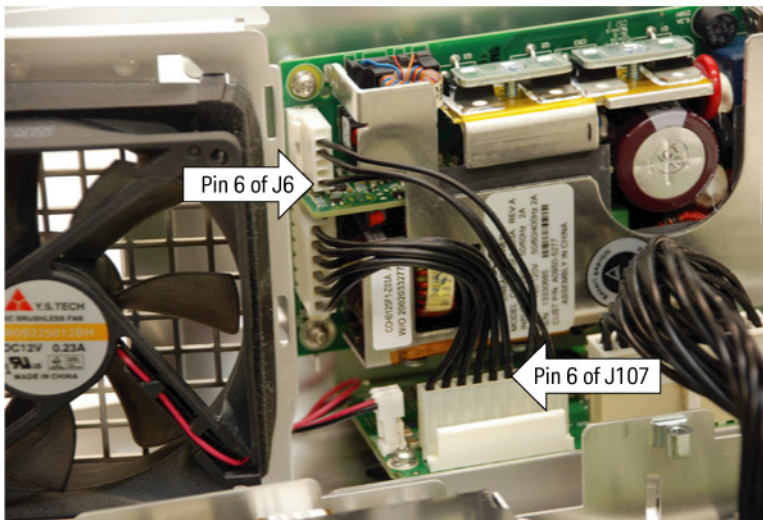

Figure 19 Verify power switch operation

- With S100 in the OFF position (switch contacts closed) you should measure less than 1 ohm of resistance.
- With S100 in the ON position (switch contacts open) you should measure at least 8k ohms.

If you do not measure these two values:

- There may be something wrong with the power switch (S100 on the line filter assembly).
- The cable that connects between J107 on the line filter assembly and J6 and J4 on the power supply could be wired wrong.
- The power supply could be defective.

To figure out which of these is causing the problem, see **"To check the power supply DC output"** on page 82.

To check the power supply DC output

This procedure checks the power supply DC output after verifying the AC input is good and checking the power switch operation.

- 1** Follow the instructions in **"To prepare for internal assembly troubleshooting"** on page 70.
- 2** Connect the negative lead of the multimeter to a ground point on the oscilloscope.
- 3** With the power cord disconnected:
 - a** Disconnect the DC supply cable that is plugged into J107 of the line filter assembly.
- 4** Connect the power cord, and turn on the oscilloscope.
- 5** Verify there is +13V between pins 1 (+) and 4 (-) of J4 on the power supply.

If +13V is not present between pins 1 and 4 of J4 on the power supply, *replace the power supply*.

If +13V is present between pins 1 and 4 of J4 on the power supply, either the cable is wired incorrectly or the power switch S100 is defective or has a solder short to ground between one or some of its pins.

- a** Turn off the oscilloscope, and disconnect the power cord.
- b** Replace the DC supply cable.
- c** Connect the power cord, and turn on the oscilloscope.
- d** Check again to see if the output of the power supply turns ON and OFF as you actuate the power switch S100.

If replacing the cable does not fix the problem, there is something wrong with the power switch S100, and you must *replace the line filter assembly*.

To check the display supplies

This procedure checks the display supply voltages on the system board test points when the display backlight power cable and the display cable are disconnected.

If one or both of these voltages are bad when the cables are connected but good when the cables are disconnected, it indicates problems with the display assembly.

- 1 Follow the instructions in **"To prepare for internal assembly troubleshooting"** on page 70.
- 2 Connect the negative lead of the multimeter to a ground point on the oscilloscope.
- 3 With the power cord disconnected:
 - a Disconnect the display backlight power cable from the system board connector J3702.
 - b Disconnect the display cable from the system board connector J2001.
- 4 Connect the power cord, and turn on the oscilloscope.
- 5 Check the display supplies:

Test Point (near J3701)	Expected Value	Assemblies Supplied	If Good	If Bad
VP23V	+22.84 V to +24.2 V	Display Backlight Power	Replace the display assembly.	Replace the system board.
VP3V3	+3.3 V \pm 3%	LCD, System Board	If good when the display cable is disconnected from the system board, but bad when the display cable is connected, this indicates a problem with either the display cable or the display assembly, <ol style="list-style-type: none"> 1 Turn off the oscilloscope, and disconnect the power cord. 2 Replace the display cable. 3 Connect the power cord, and turn on the oscilloscope. If the problem is not fixed, replace the display assembly.	Replace the line filter board.

To check the keyboard supplies

This procedure checks the keyboard supply voltages on the system board test points when the keyboard cable is disconnected.

If one or both of these voltages are bad when the keyboard cable is connected but good when the cable is disconnected, it indicates problems with the keyboard assembly.

- 1 Follow the instructions in **"To prepare for internal assembly troubleshooting"** on page 70.
- 2 Connect the negative lead of the multimeter to a ground point on the oscilloscope.
- 3 With the power cord disconnected:
 - a Disconnect the keyboard cable from the system board connector J3403.
- 4 Connect the power cord, and turn on the oscilloscope.
- 5 Check the keyboard supplies:

Test Point (near J3701)	Expected Value	Assemblies Supplied	If Good	If Bad
VP5V	+5 V \pm 3%	Keyboard, System Board	If good when the keyboard cable is disconnected from the system board, but bad when the keyboard cable is connected, this indicates a problem with either the keyboard cable or the keyboard, <ol style="list-style-type: none"> 1 Turn off the oscilloscope, and disconnect the power cord. 2 Replace the keyboard cable. 3 Connect the power cord, and turn on the oscilloscope. a If the problem is not fixed, replace the keyboard. 	Replace the line filter board.
VP13V_PRB	+13 V \pm 3%	AutoProbe Interface		Replace the system board.

To check the fan

The fan speed is controlled by a circuit on the line filter board.

If the fan is running, perform the hardware self-tests. Go to **"To perform hardware self test"** on page 65.

If the fan is not running, it may be defective. Follow these steps:

- 1 Follow the instructions in **"To prepare for internal assembly troubleshooting"** on page 70.

- 2 Disconnect the fan cable from the line filter board.
- 3 Connect the power cord, and turn on the oscilloscope.
- 4 Measure the fan voltage at the connector on the line filter board.

See the following figure for the location of the fan connector.

- 5 If the fan voltage is approximately +6.5 Vdc at room temperature, replace the fan. If the fan voltage is not approximately +6.5 Vdc, *replace the line filter board*.

The proper voltage range depending on temperature is between +6.5 Vdc to +8.5 Vdc.

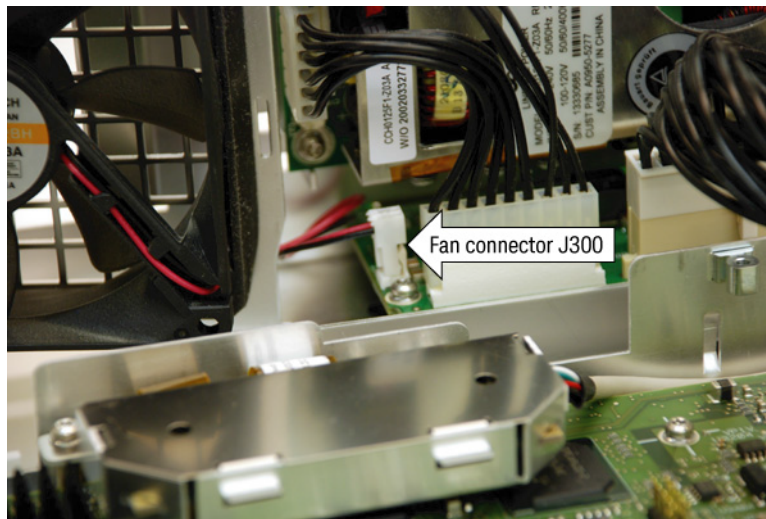

Figure 20 Location of the Fan Connector

5 Replacing Assemblies

This chapter describes how to remove assemblies from an oscilloscope. To install a replacement assembly after you have removed an old one, follow the instructions in reverse order.

The parts shown in the following figures are representative and may look different from what you have in your oscilloscope.

Instructions for removable assemblies include:

- To remove the front panel knobs / 89
- To remove the bucket assembly / 90
- To remove the power supply / 123
- To remove the rear deck assembly / 95
- To replace the battery / 102
- To remove the touch controller board / 103
- To remove the acquisition board / 107
- To remove the front panel assembly / 113
- To remove the display assembly / 119
- To remove the fan assembly / 121
- To remove the power supply / 123
- To remove the line filter board / 126

Tools Used for Disassembly

Use these tools to remove and replace the oscilloscope assemblies:

- T6, T10, and T20 TORX drivers.
- 5/8-inch socket driver or adjustable wrench (for BNC nuts).
- Flat head screw driver.

See how the Oscilloscope Parts Fit Together

An exploded view of the oscilloscope is included in the “Replaceable Parts” chapter. It shows the individual part numbers used in the assemblies, and shows you how the parts fit together.

Read All Warnings and Cautions

Read the following warnings and cautions before removing and replacing any assemblies in the oscilloscope.

WARNING

HAZARDOUS VOLTAGES!

Read the safety summary at the back of this book before proceeding. Maintenance is performed with power supplied to the oscilloscope and with the protective covers removed. Only trained service personnel who are aware of the hazards involved should perform the maintenance. Whenever possible, perform the procedures with the power cord removed from the oscilloscope.

WARNING



AVOID ELECTRICAL SHOCK!

Hazardous voltages exist on the LCD assembly and power supply. To avoid electrical shock:

- 1 Disconnect the power cord from the oscilloscope.
- 2 Wait at least three minutes for the capacitors in the oscilloscope to discharge before you begin disassembly.

Read the Safety Summary at the back of this manual before you begin.

CAUTION

REMOVE POWER TO AVOID DAMAGE!

Remove power before you begin to remove and replace assemblies. Do not remove or replace assemblies while the oscilloscope is turned on, or damage to the components can occur.

CAUTION

AVOID DAMAGE TO ELECTRONIC COMPONENTS!

ELECTROSTATIC DISCHARGE (ESD) can damage electronic components. When doing any of the procedures in this chapter, use proper ESD precautions. As a minimum, you should place the instrument on a properly grounded ESD mat and wear a properly grounded ESD strap.

To remove the front panel knobs

The front panel knobs must be removed prior to localized front panel overlay installation or front panel disassembly.

- 1 Gently pull on the front panel knobs to remove them.



Figure 21 Removing the front panel knobs

To remove the bucket assembly

Removing the bucket assembly gives you access to the rear deck, fan assembly, power supply cover, power supply assembly, and power switch assembly.

- 1 Using T20 TORX driver, remove the four screws securing the bucket assembly to rear deck assembly.

You must open the storage compartment lid to access one of the screws.

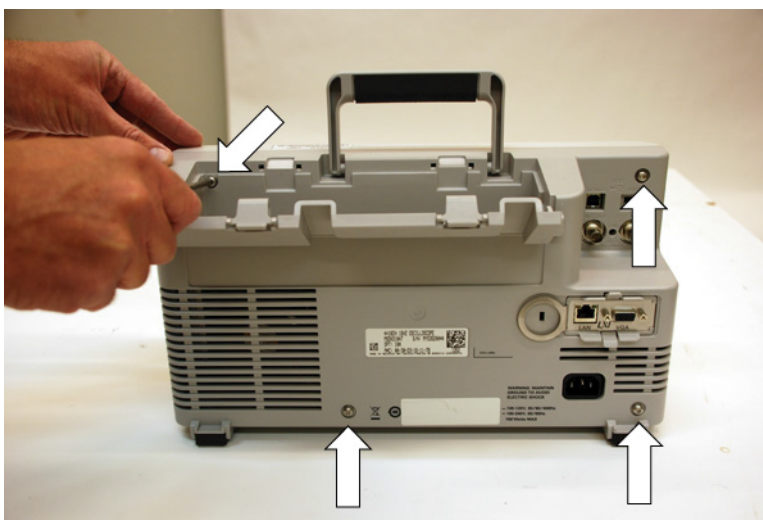

Figure 22 Removing the bucket screws

- 2 Carefully slide bucket assembly back away from rear deck assembly.

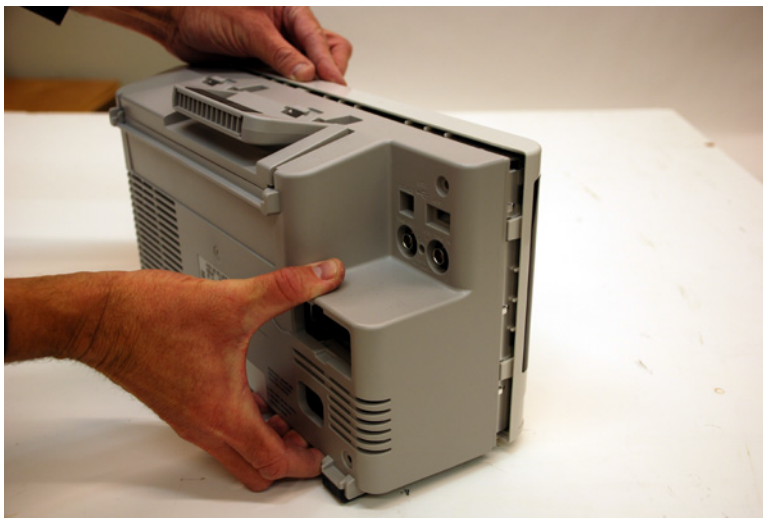

Figure 23 Removing bucket assembly

To remove the power supply shield

- 1 Using a TORX T10 driver, locate and remove the screw securing the power supply shield to the rear deck.

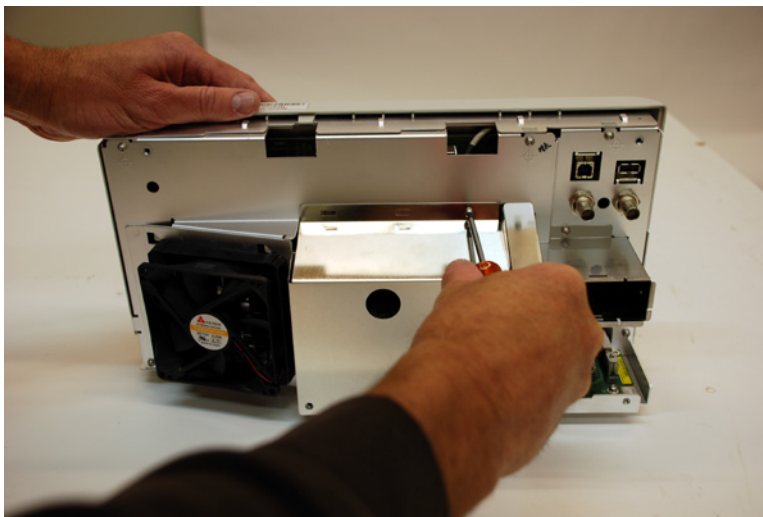

Figure 24 Removing the power supply shield screw

WARNING

Sheet metal parts may have sharp edges. Handle with care to avoid injury.

- 2 When the screw has been removed, unclip the right side of the shield from the rear deck.



Figure 25 Unclipping the power supply shield right side

- 3 When the screw has been removed and the shield has been unclipped, carefully remove the shield by lifting the cover upward and then pulling its tabs out of the slots on the rear deck.

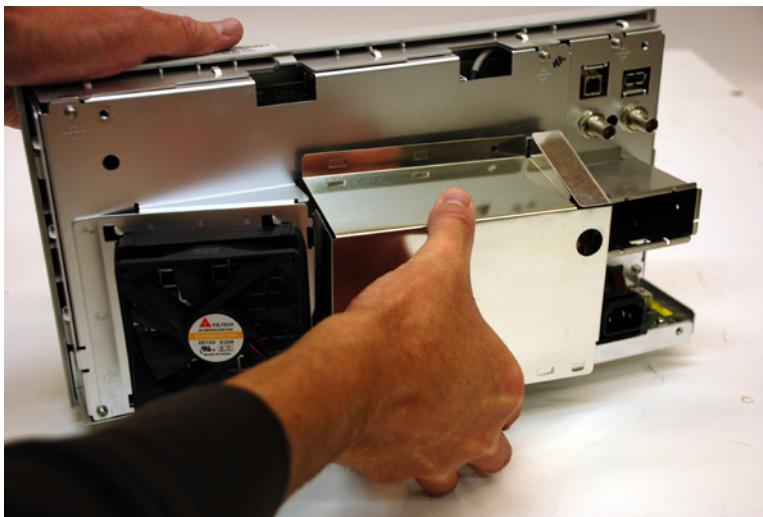

Figure 26 Removing the power supply shield - lift and pull out

To remove the rear deck assembly

Removing the rear deck allows access to the front deck and acquisition board.

- 1 Remove BNC securing nuts and washers.



Figure 27 Removing the BNC nuts and washers

- 2 Using a T10 TORX driver, locate and remove all screws securing rear deck to front deck.

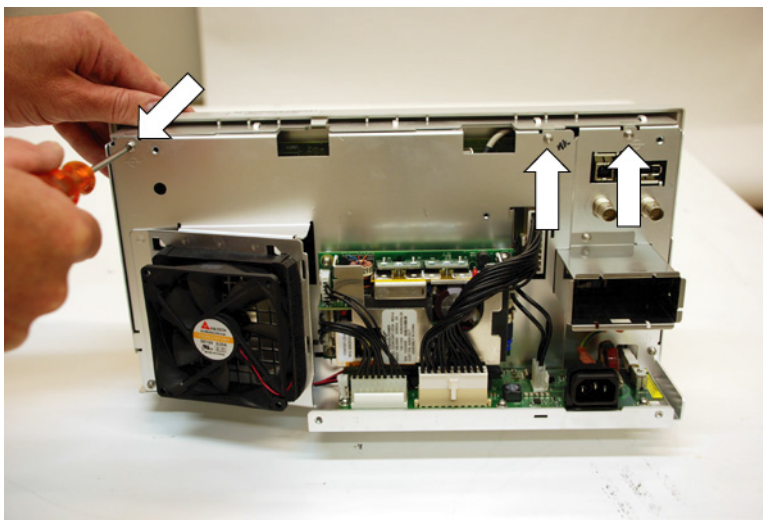

Figure 28 Removing the top rear deck screws



Figure 29 Removing the bottom right rear deck screw

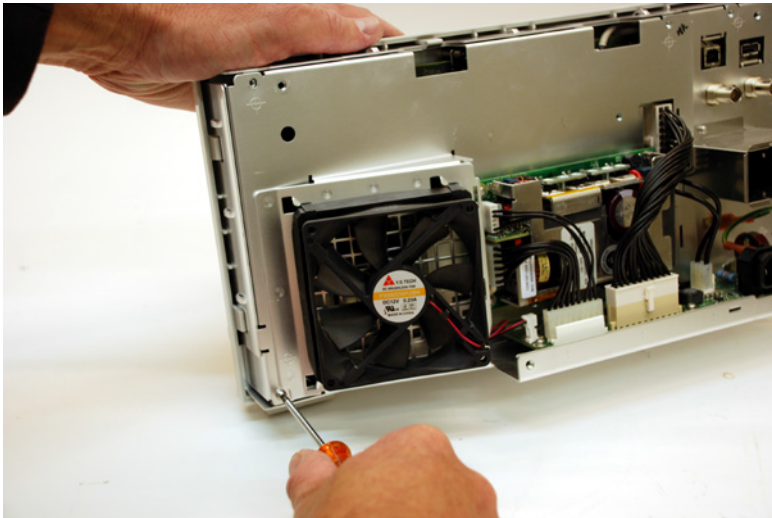

Figure 30 Removing the bottom left rear deck screw

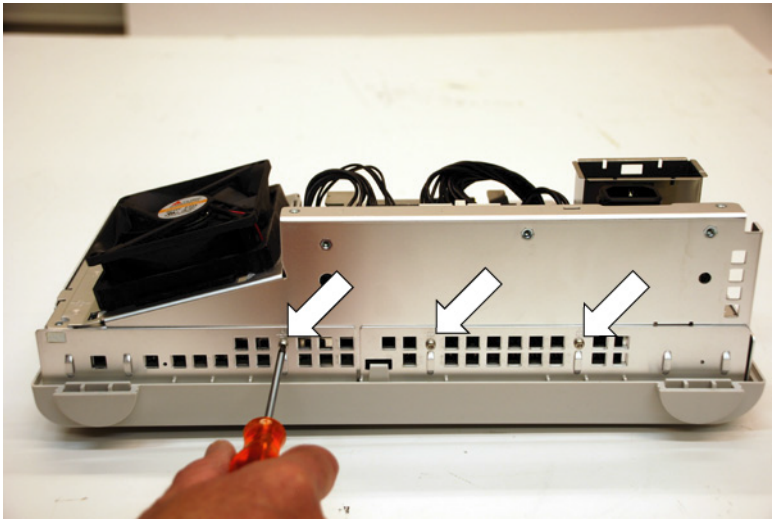

Figure 31 Removing the bottom rear deck screws



Figure 32 Removing the option module guide to acquisition board screw

- 3** If the power supply shield has not already been removed, do that now. See **"To remove the power supply shield"** on page 92.

- 4 Disconnect the interboard supply cable from the acquisition board.
You may need to use a screwdriver to pry the connector latch.

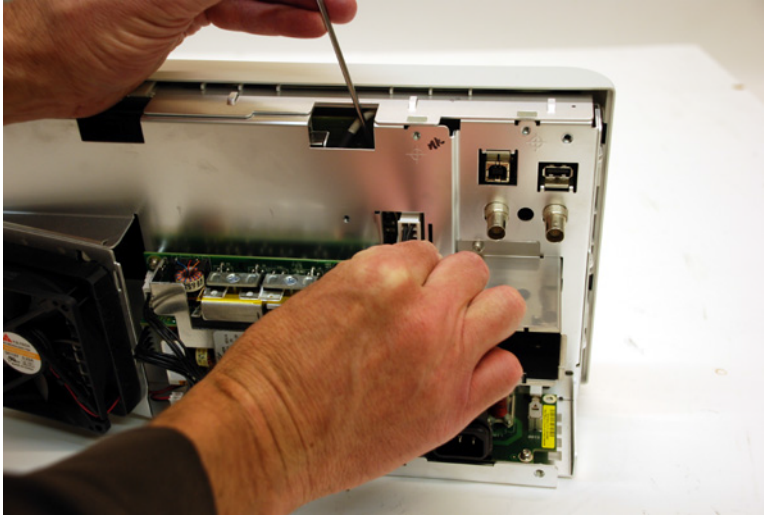

Figure 33 Disconnecting the interboard supply cable from the acquisition board

- 5 Carefully separate the rear deck from the front deck.
 - a Lift the front bezel latch that holds the rear deck.

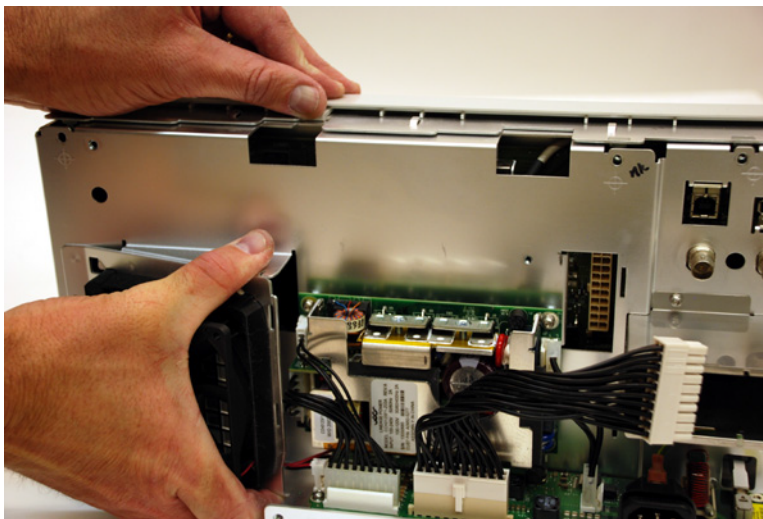

Figure 34 Lifting front bezel latch

- b** Carefully separate the rear deck from the front deck.
Take care not to damage the extender switch.



Figure 35 Separating the rear and front decks

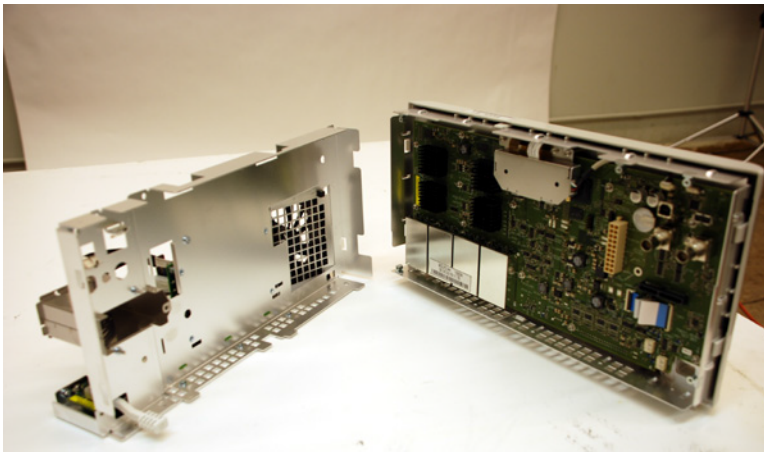

Figure 36 Rear and front decks separated

To replace the battery

If the battery needs to be replaced, use a CR2032/1HG or CR2032/HGN 3V manganese dioxide lithium battery.



Figure 37 Battery location

To remove the touch controller board

- 1 Remove 2 screws.

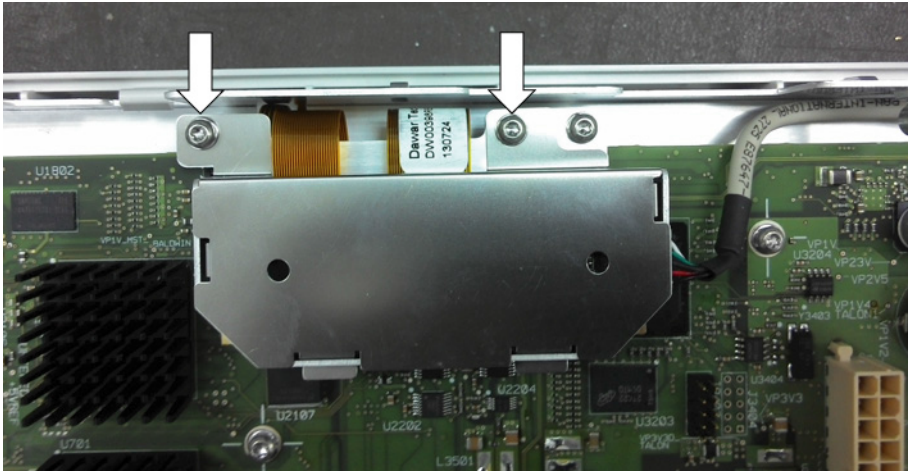

- 2 Rotate shield toward bracket wall.

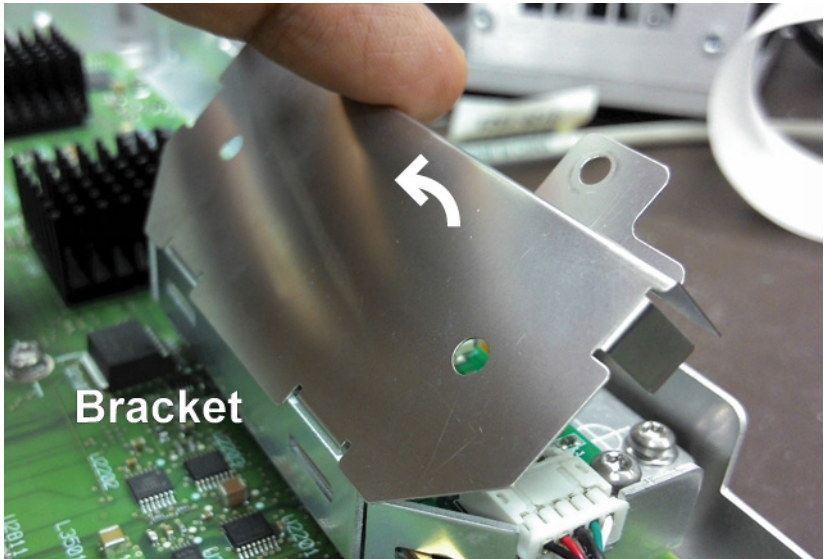

- 3 Rotate more than 45° and shield can be released from bracket.

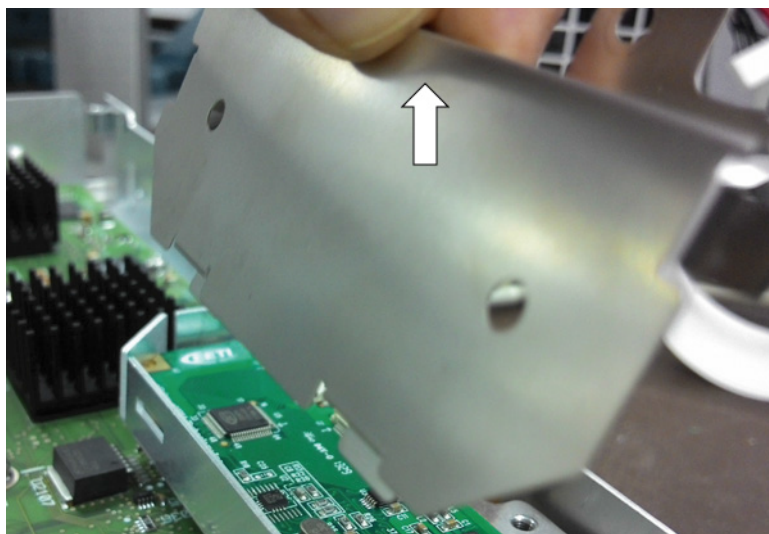

- 4 Disconnect all cables.

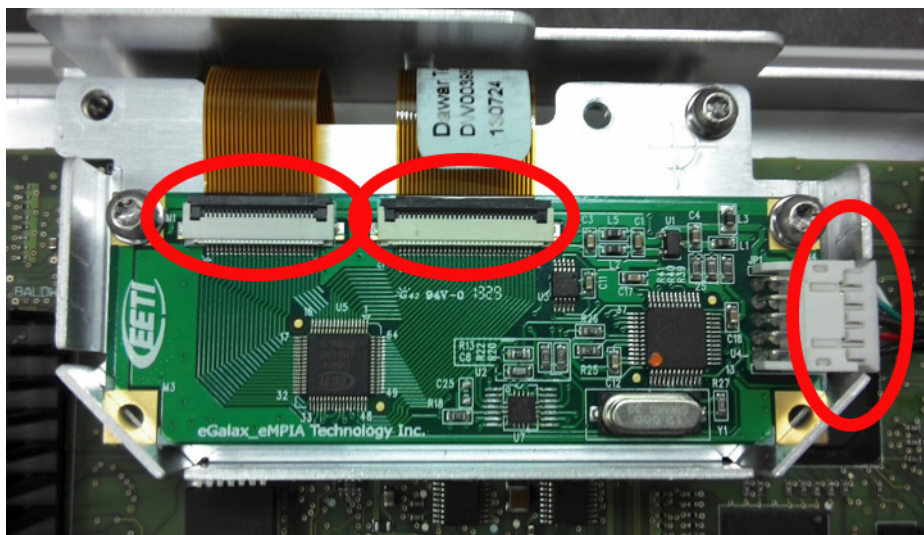

5 Remove 2 screws.

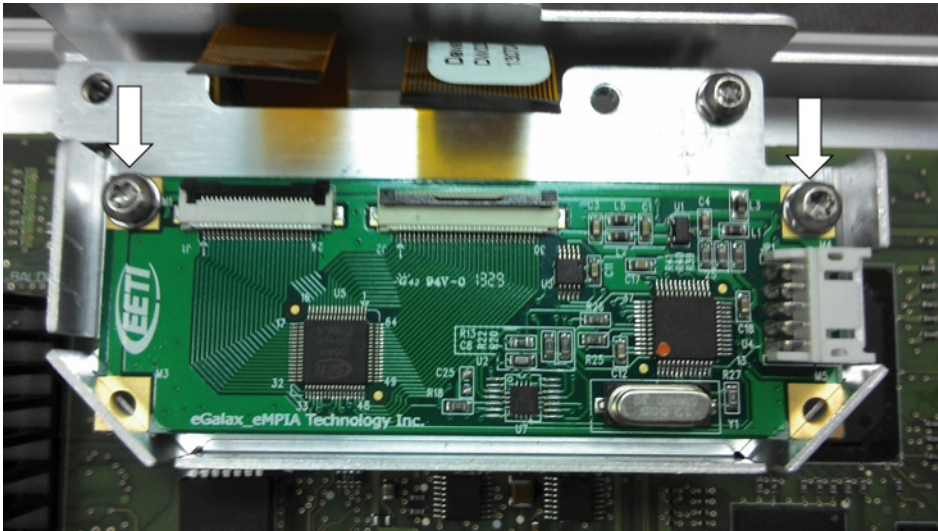

6 Slide controller board up to release it from bracket.

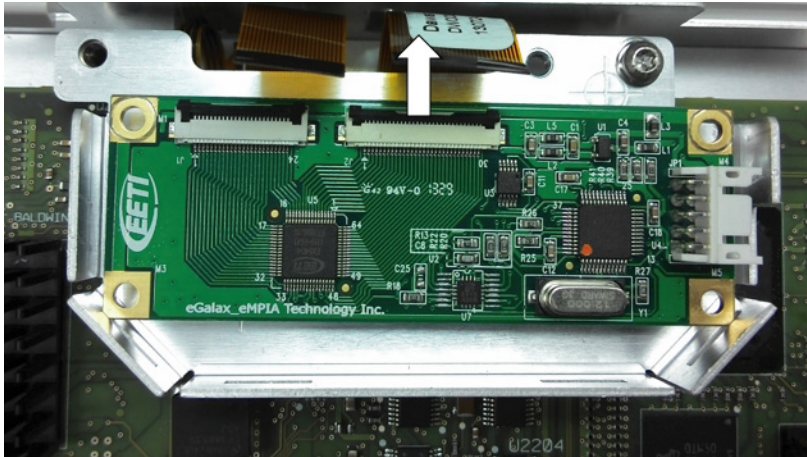

5 Replacing Assemblies

To assemble, reverse steps above. When rotating Shield to assemble to Bracket, push both ground fingers into Bracket.

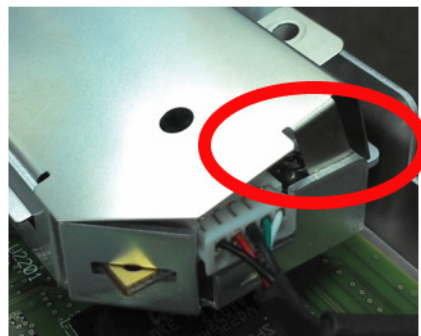
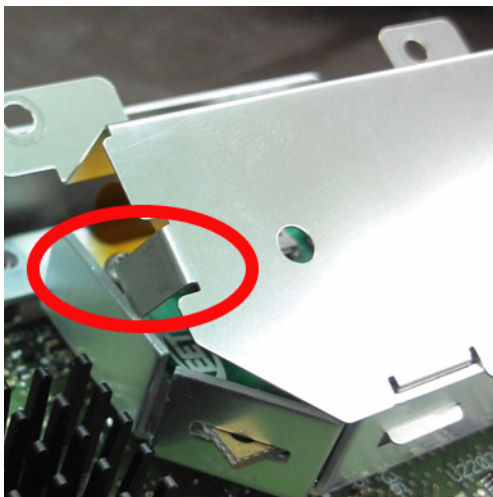

To remove the acquisition board

These steps describes how to remove the acquisition board.

- 1 Using a TORX T6 driver, locate and remove the 4 screws on the front of the instrument (4 Channel version).

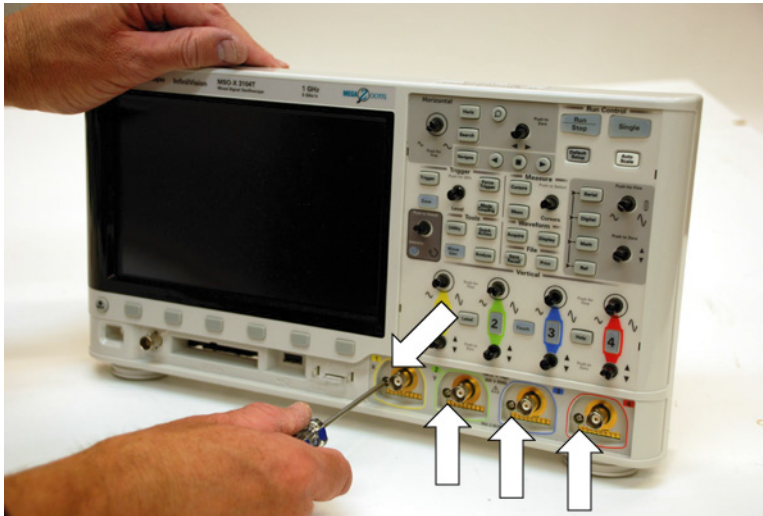

Figure 38 Removing the T6 screws (4 channel version)

- 2 Using a TORX T10 driver, locate and remove the 2 screws securing the controller board bracket.

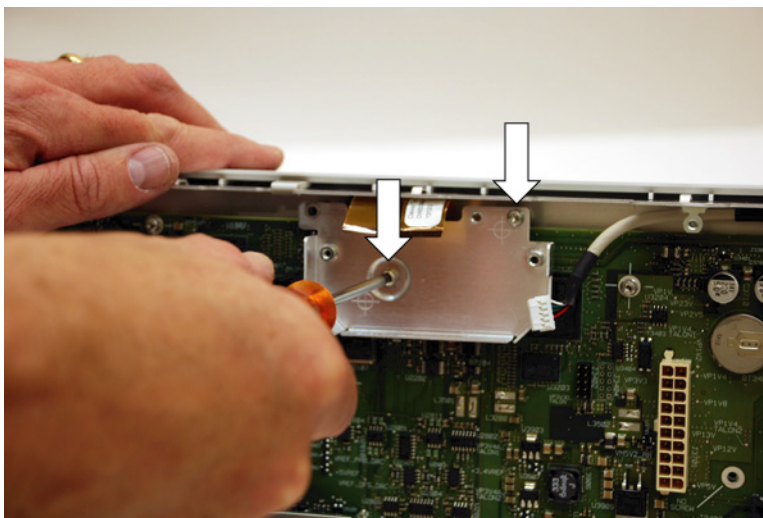

Figure 39 Removing the controller board bracket

3 Disconnect keyboard, display, and display backlight power cables.

For the keyboard and display cables, flip up the connector clamp; then, slide the ribbon cables out.

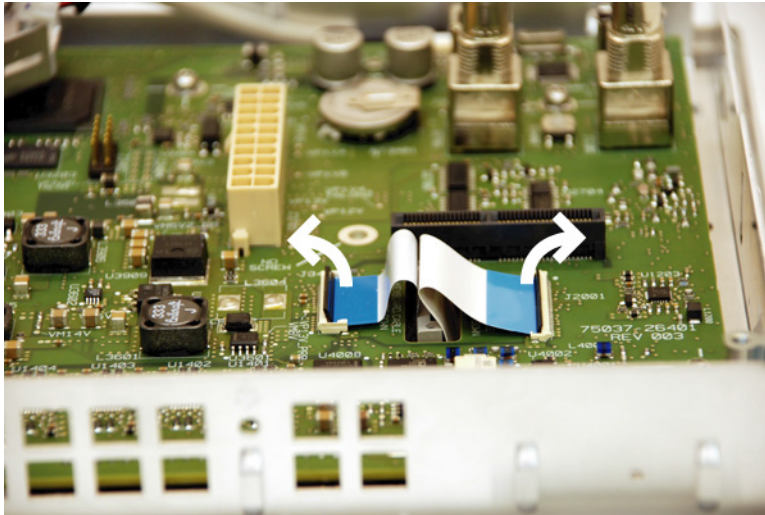

Figure 40 Disconnecting keyboard and display cables from acquisition board

For the display backlight power cable, slide the connector clamp toward the top of the acquisition board; then, slide the ribbon cable out.

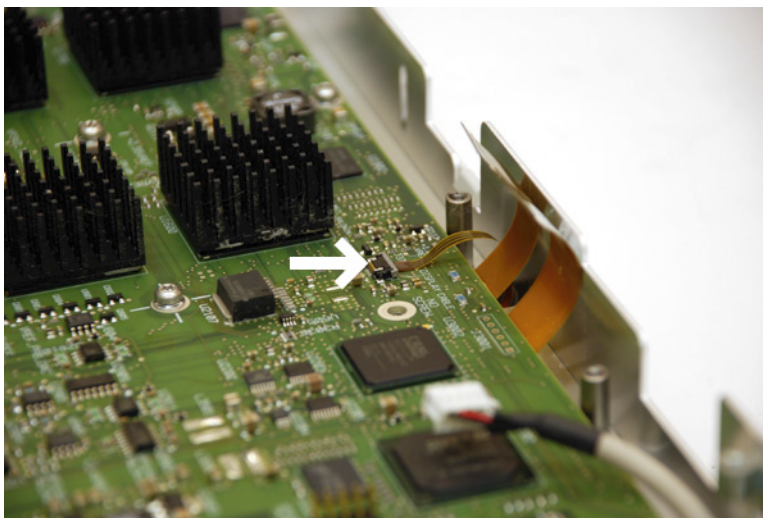

Figure 41 Disconnecting display backlight power cable from acquisition board

4 Using a TORX T10 driver, locate and remove 12 mounting screws.

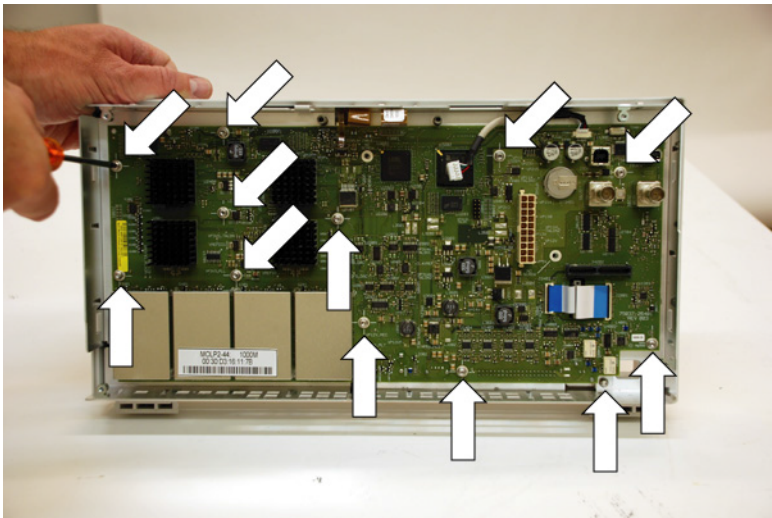

Figure 42 Acquisition board mounting screw locations

5 Carefully lift the acquisition board off the front deck.

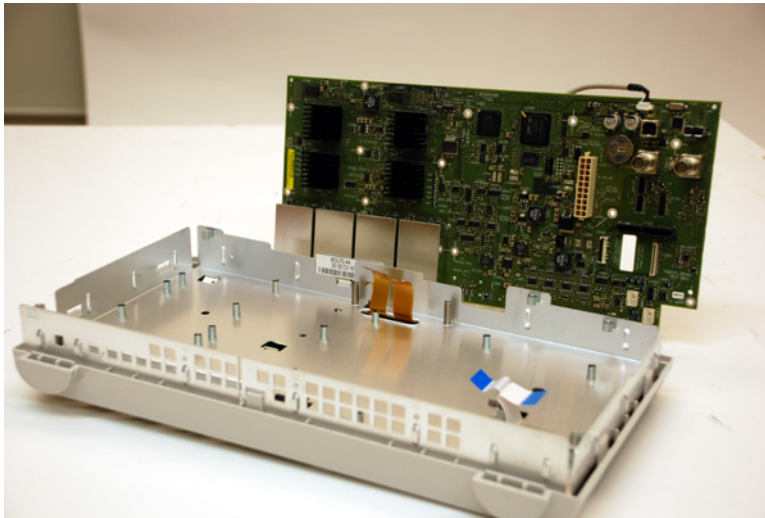

Figure 43 Acquisition board removed from front deck

To remove the front panel assembly

WARNING

Thin sheet metal parts may have sharp edges. Handle with care to avoid injury.

- 1 Remove the bezel from the front deck.

The bezel is secured to front deck by molded-in retaining clips located around the perimeter of the bezel.

Gently pry the retaining clips outward (either by hand or using a flat head screwdriver). Work your way around the bezel, releasing the clips and gently lifting the front deck away from the bezel.

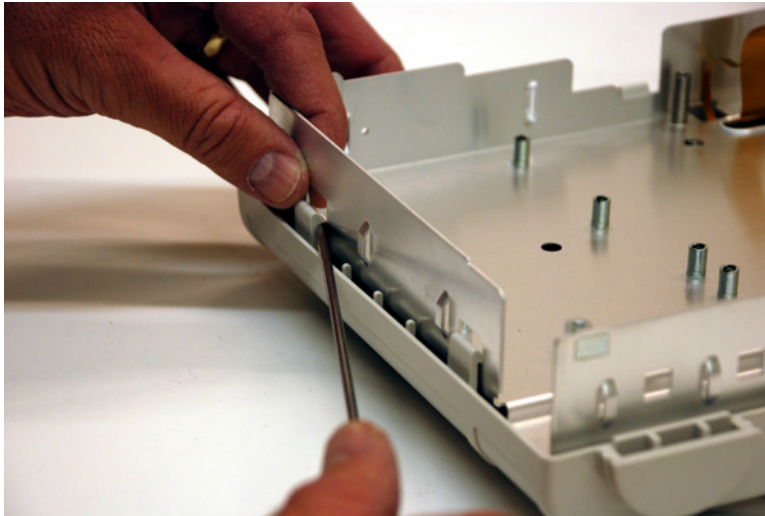

Figure 44 Release the bezel clips from the front deck

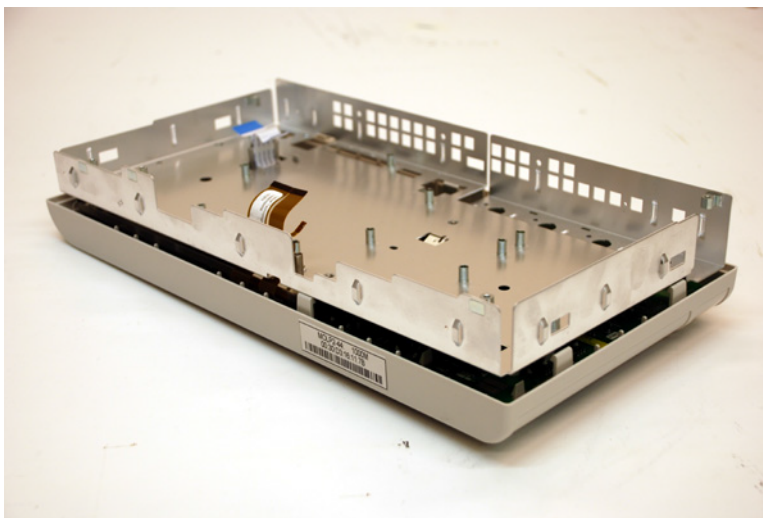

Figure 45 All bezel clips released

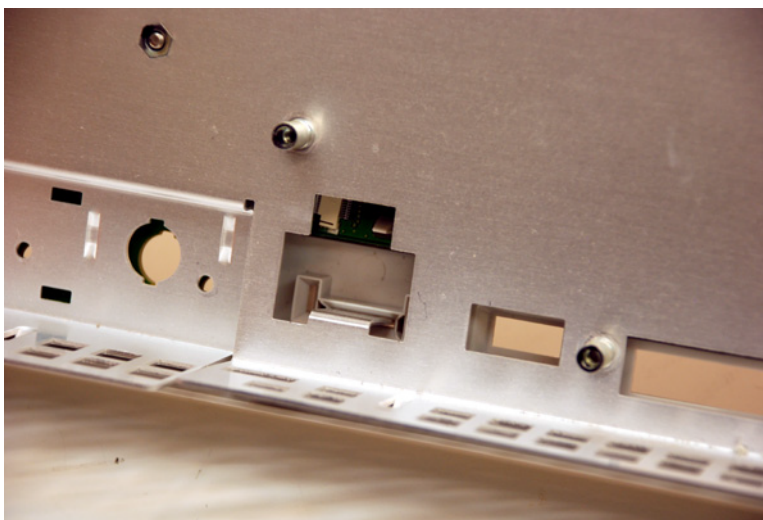

Figure 46 HINT: When reinstalling bezel, align ground terminal first

- 2 When all the bezel clips are released, gently lift the front deck away from the bezel, and disconnect the keyboard cable.

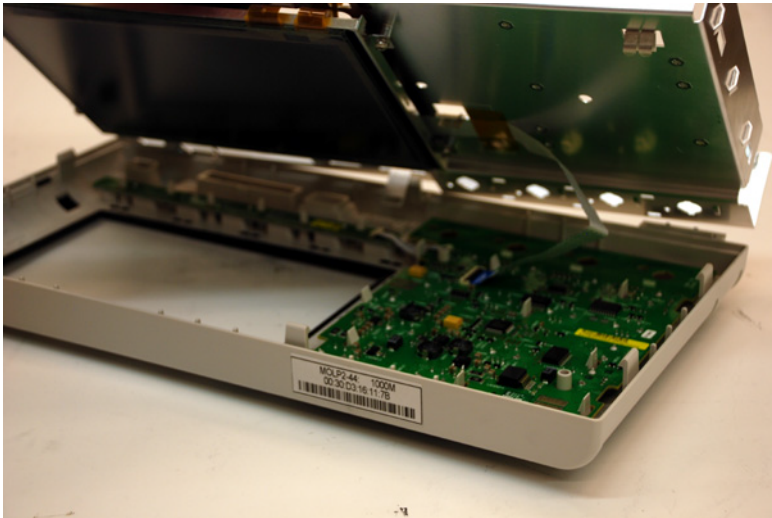

Figure 47 Gently lift front deck from bezel

Flip up the keyboard cable connector clamp; then, slide the ribbon cable out.

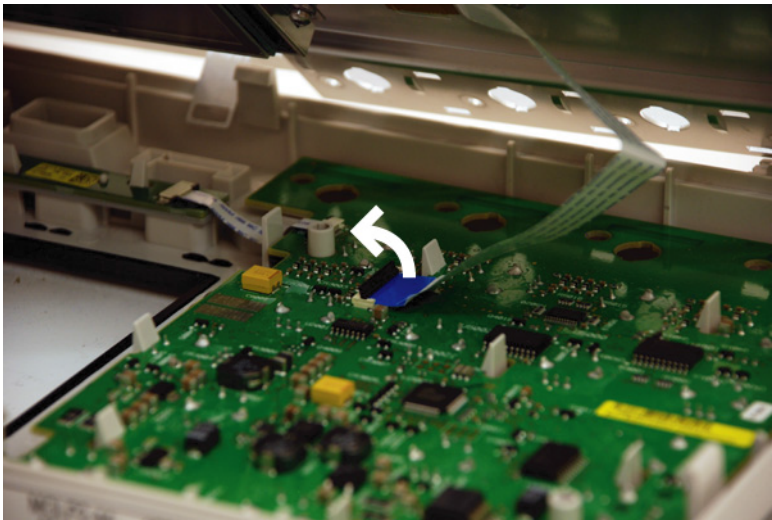

Figure 48 Disconnect the keyboard cable

3 Remove the softkey board cable from the keyboard board.

Slide the connector clamp toward the softkey board; then, slide the ribbon cable out.

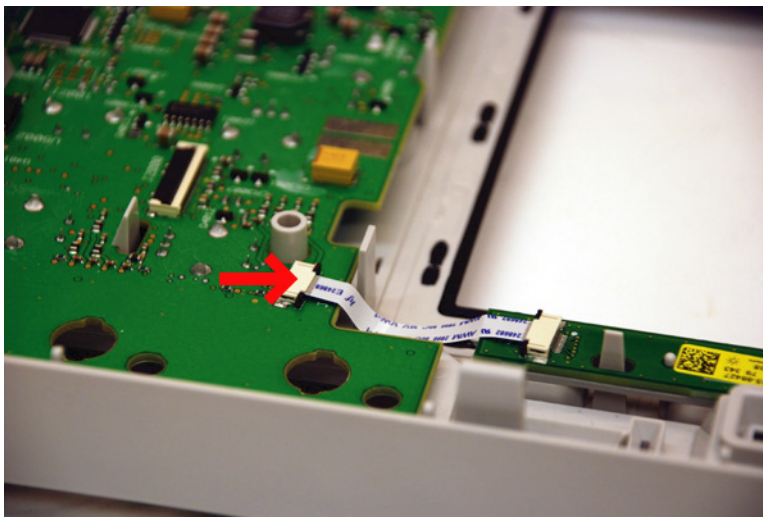

Figure 49 Disconnect the softkey board cable

- 4 To separate the softkey board from the bezel, carefully pull back locking tabs that secure it.



Figure 50 Unclip the softkey board from the bezel

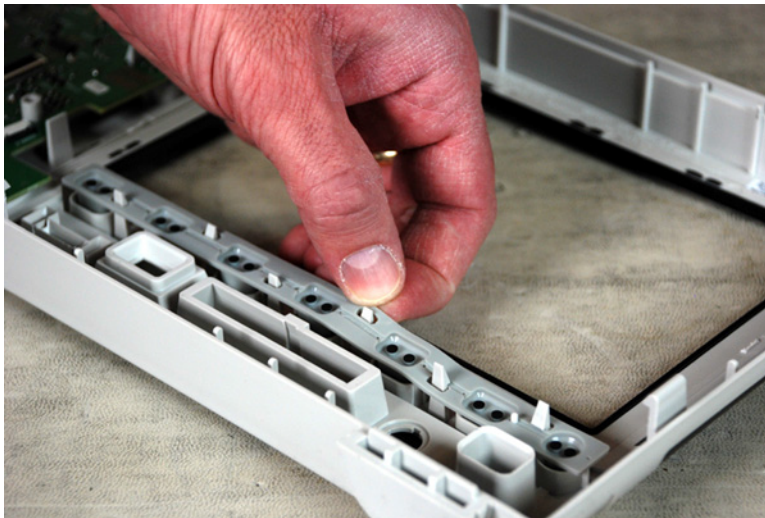

Figure 51 Remove the softkey keypad from the bezel

- 5 To separate the keyboard board from the bezel, carefully pull back locking tabs that secure it.

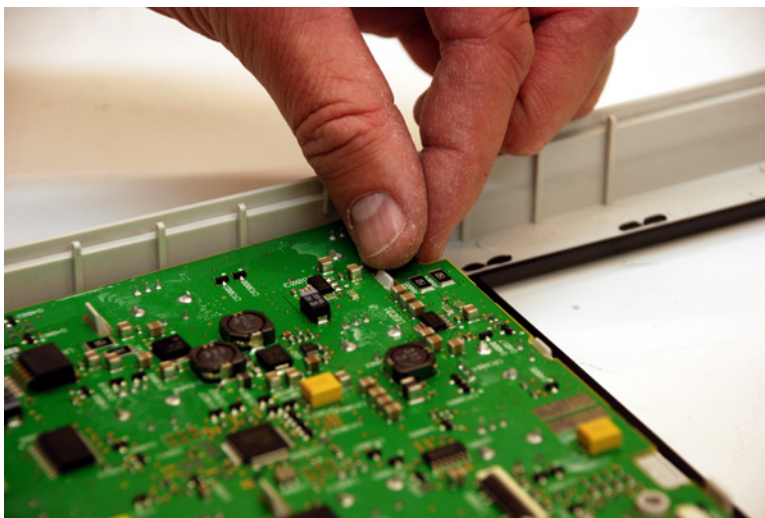

Figure 52 Unclip the keyboard board from the bezel

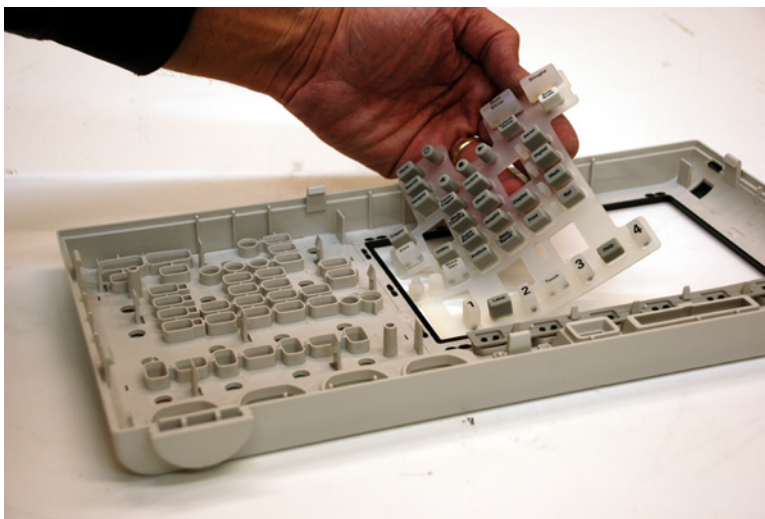

Figure 53 Remove the keyboard keypad from the bezel

To remove the display assembly

The display assembly is part of the front panel assembly. Before you can remove and replace the display assembly, you must remove the front panel assembly. See [“To remove the front panel assembly”](#) on page 113.

WARNING

Thin sheet metal parts may have sharp edges. Handle with care to avoid injury.

- 1 Using a TORX T10 remove the four screws that secure the display to the front deck.

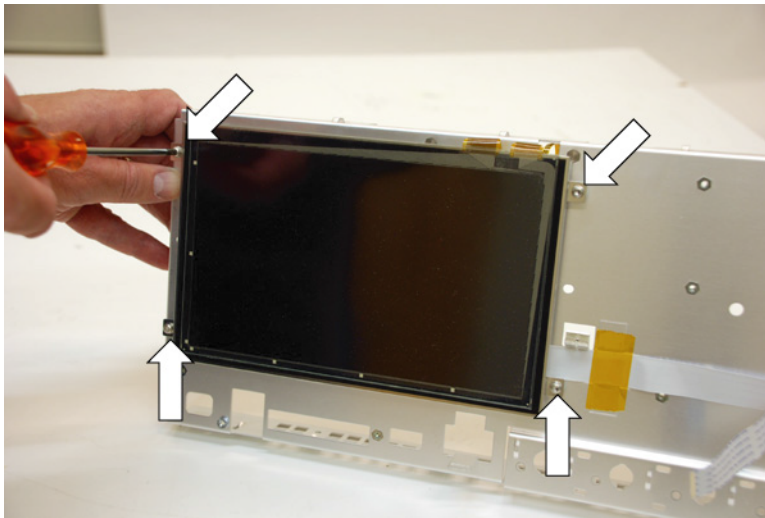

Figure 54 Removing the display assembly

Take care while threading display cables thru front deck sheet metal openings.

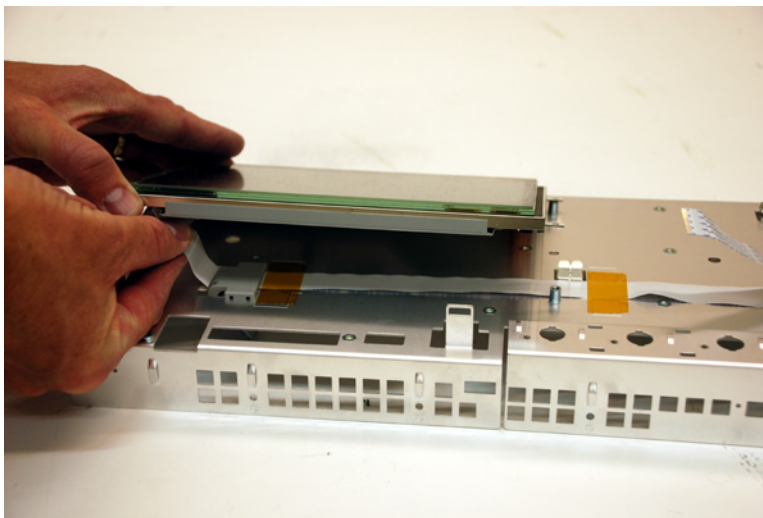

Figure 55 Display assembly removed

To remove the fan assembly

- 1 Ensure that fan power cable has been disconnected from acquisition board.

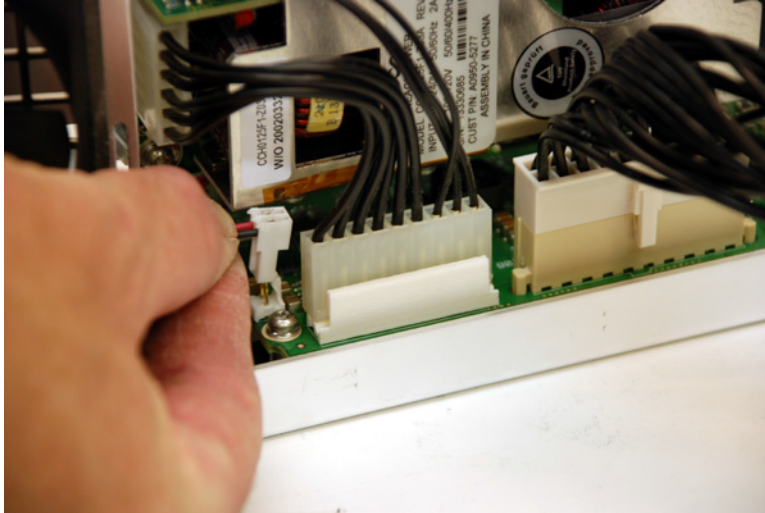

Figure 56 Disconnecting fan power cable

- 2 Carefully slide fan assembly (fan and fan mount) to the right, then lift away from rear deck.

Note, fan mount is soft and can be damaged by sharp sheet metal edges. Take care that the fan power cable is not damaged when pulling across sheet metal edges.

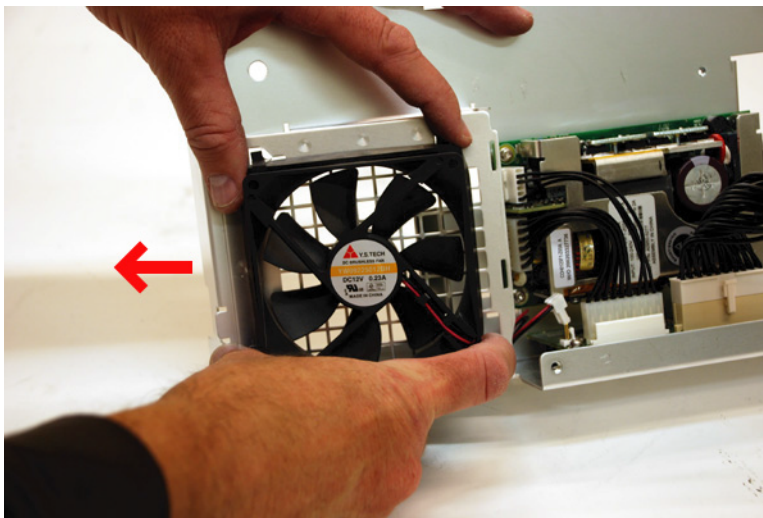

Figure 57 Removing fan assembly

To remove the power supply

- 1 Disconnect all cables from power supply board.

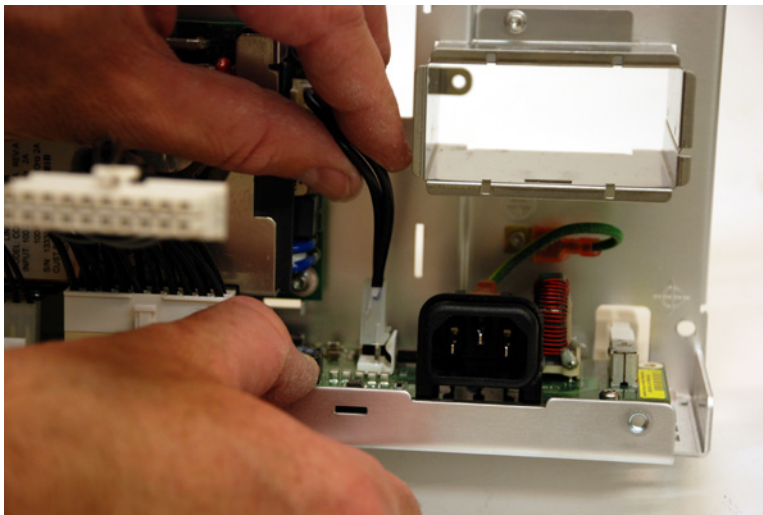

Figure 58 Disconnecting the AC cable

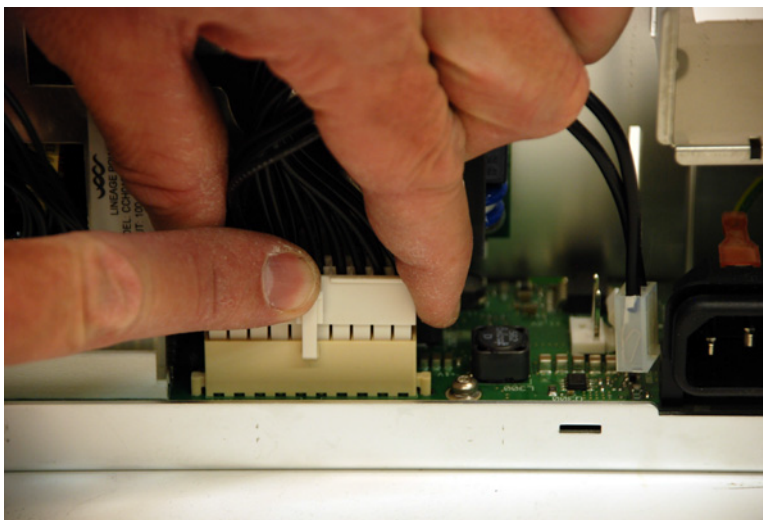

Figure 59 Disconnecting the interboard supply cable from the line filter board

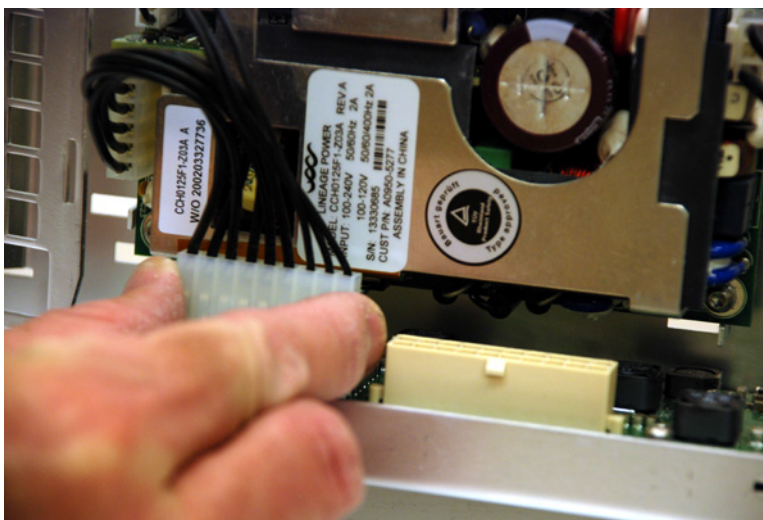

Figure 60 Disconnecting the DC cable from the line filter board

- 2 Using a TORX T10 driver, locate and remove the four screws securing the power supply assembly to the rear deck.

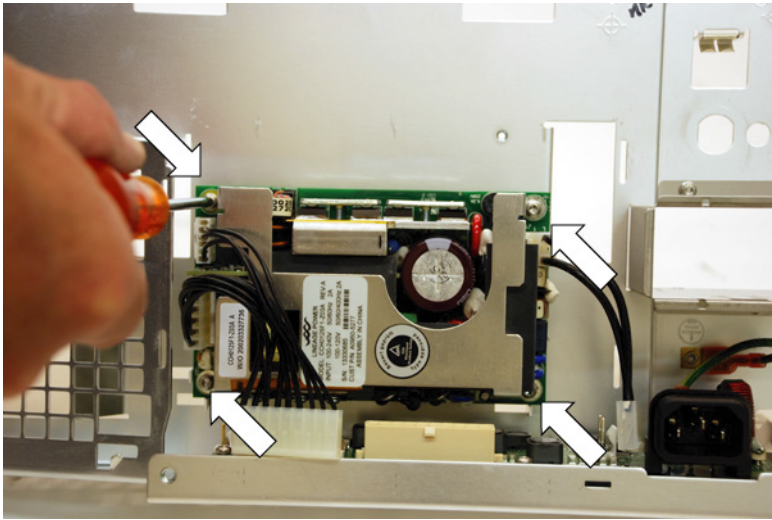

Figure 61 Removing the power supply

To remove the line filter board

- 1 Disconnect all cables on the line filter board.
- 2 Remove the option module guide.

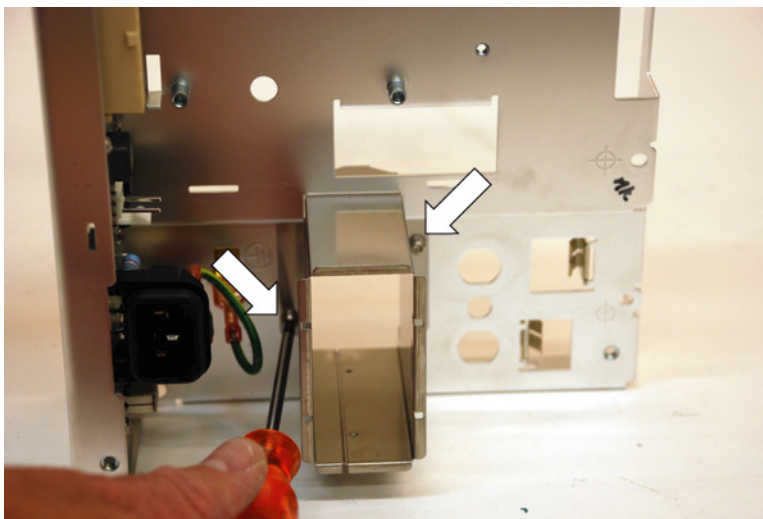

Figure 62 Removing the option module guide

- 3 Disconnect the ground wire from its chassis terminal.

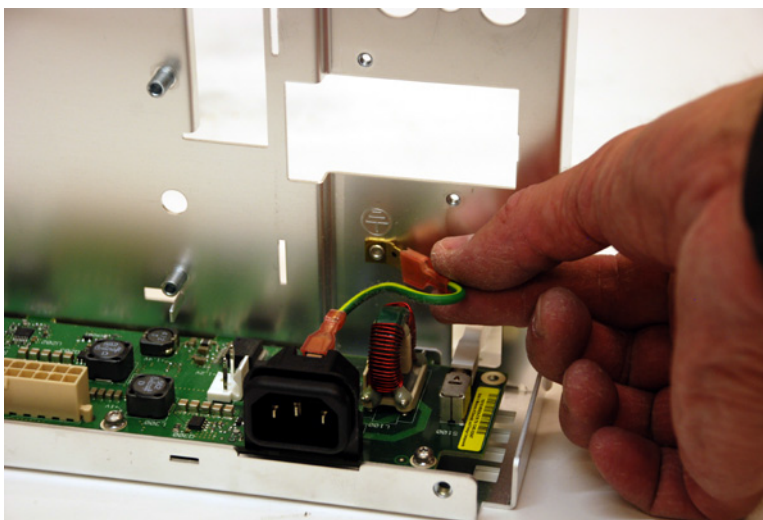

Figure 63 Disconnecting the ground wire

- 4 Using a TORX T10 driver, locate and remove the three screws securing the line filter board to the rear deck.

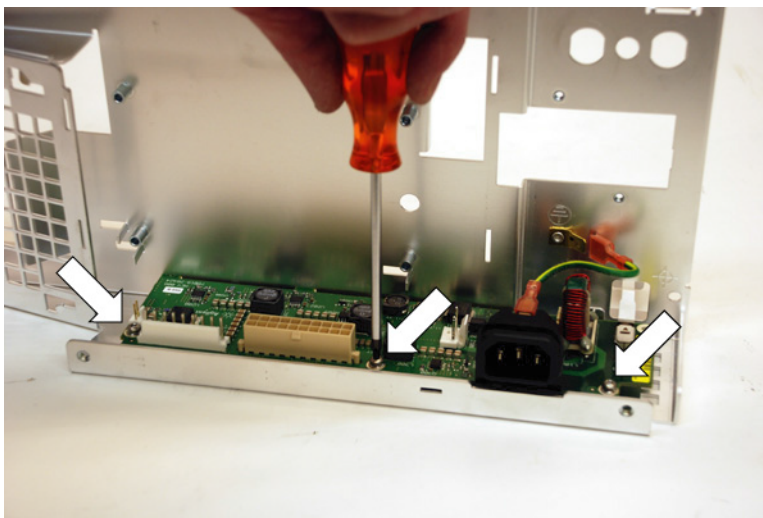

Figure 64 Removing the line filter board screws

- 5 Slide the line filter board out of the slots in the rear deck.
Take care that you do not damage the switch extender during removal.

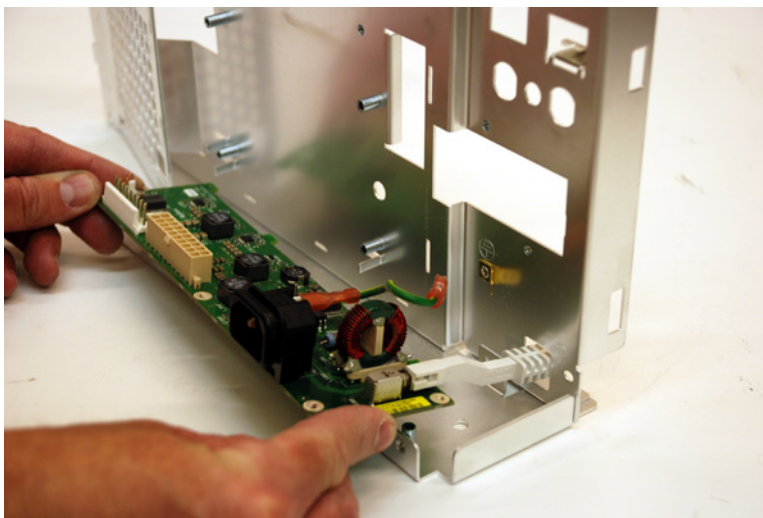

Figure 65 Removing the line filter board

- 6 To remove the switch extender, gently pry open the extender using a flat head screwdriver.

CAUTION

Twisting the latch too much could cause it to break!

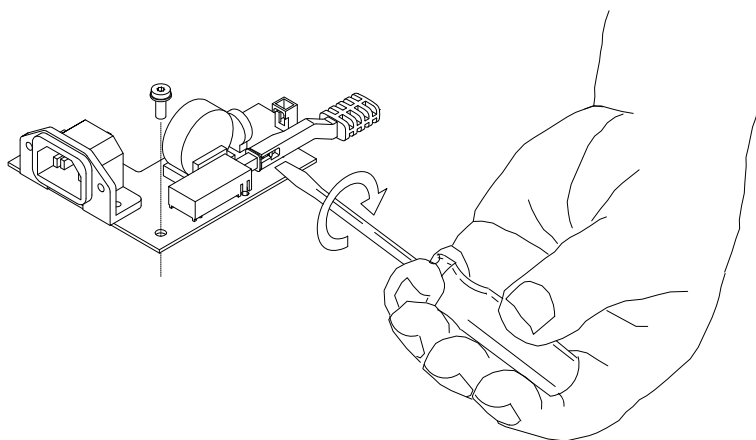

Figure 66 Removing the power switch extender

6 Replaceable Parts

This chapter describes how to order replaceable assemblies and parts for the Keysight 3000T X-Series oscilloscopes.

Diagrams and parts lists are included for assemblies and hardware that you can order.

Before working on the oscilloscope, read the safety summary at the back of this book.

Ordering Replaceable Parts

Listed Parts

To order a part in the parts list, quote the Keysight Technologies part number, indicate the quantity desired, and address the order to the nearest Keysight Technologies Sales Office. To find your nearest sales office go to **www.keysight.com**.

Unlisted Parts

To order a part not listed in the parts list, include the instrument part number, instrument serial number, a description of the part (including its function), and the number of parts required. Address the order to the nearest Keysight Technologies Sales Office.

Direct Mail Order System

Within the USA, Keysight Technologies can supply parts through a direct mail order system. There are several advantages to this system:

- Direct ordering and shipping from the Keysight Technologies parts center in California, USA.
- No maximum or minimum on any mail order. (There is a minimum amount for parts ordered through a local Keysight Technologies Sales Office when the orders require billing and invoicing.)
- Prepaid transportation. (There is a small handling charge for each order.)
- No invoices.

In order for Keysight Technologies to provide these advantages, please send a check or money order with each order.

Mail order forms and specific ordering information are available through your local Keysight Technologies Sales Office. Addresses and telephone numbers are located in a separate document shipped with the manuals.

Exchange Assemblies

Some parts used in this instrument have been set up for an exchange program. This program allows the customer to exchange a faulty assembly with one that has been repaired, calibrated, and performance-verified by the factory. The cost is significantly less than that of a new part. The exchange parts have a part number in the form XXXXX-695XX.

After receiving the repaired exchange part from Keysight Technologies, a United States customer has 30 days to return the faulty assembly. For orders not originating in the United States, contact the local Keysight Technologies service organization. If the faulty assembly is not returned within 30 days, the customer will be charged an additional amount. The additional amount will be the difference in price between a new assembly and that of an exchange assembly.

Exploded Views

The following exploded views provide a graphical representation of the oscilloscope at the time this manual was released. Not all parts are shown. Your parts may be slightly different than those shown. These views provide reference designator numbers that map to those used in the parts list table in this chapter.

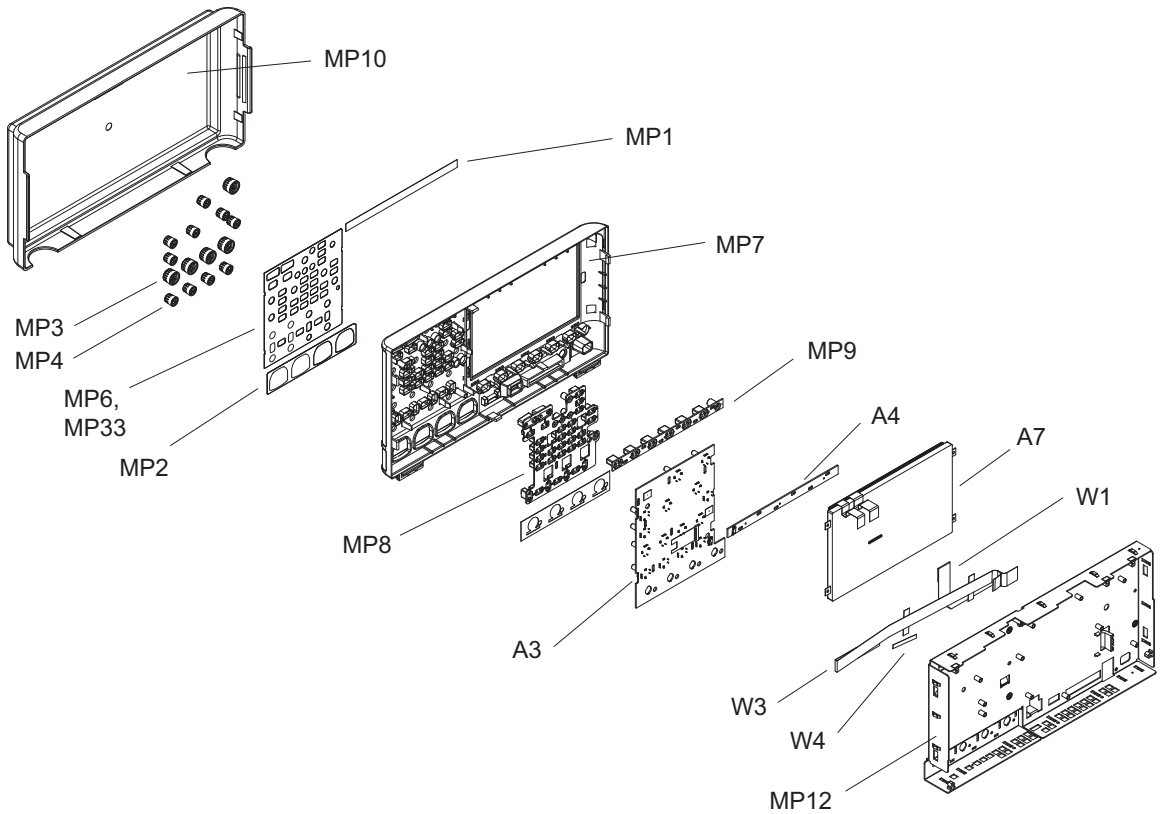

Figure 67 Exploded View 1 of 2

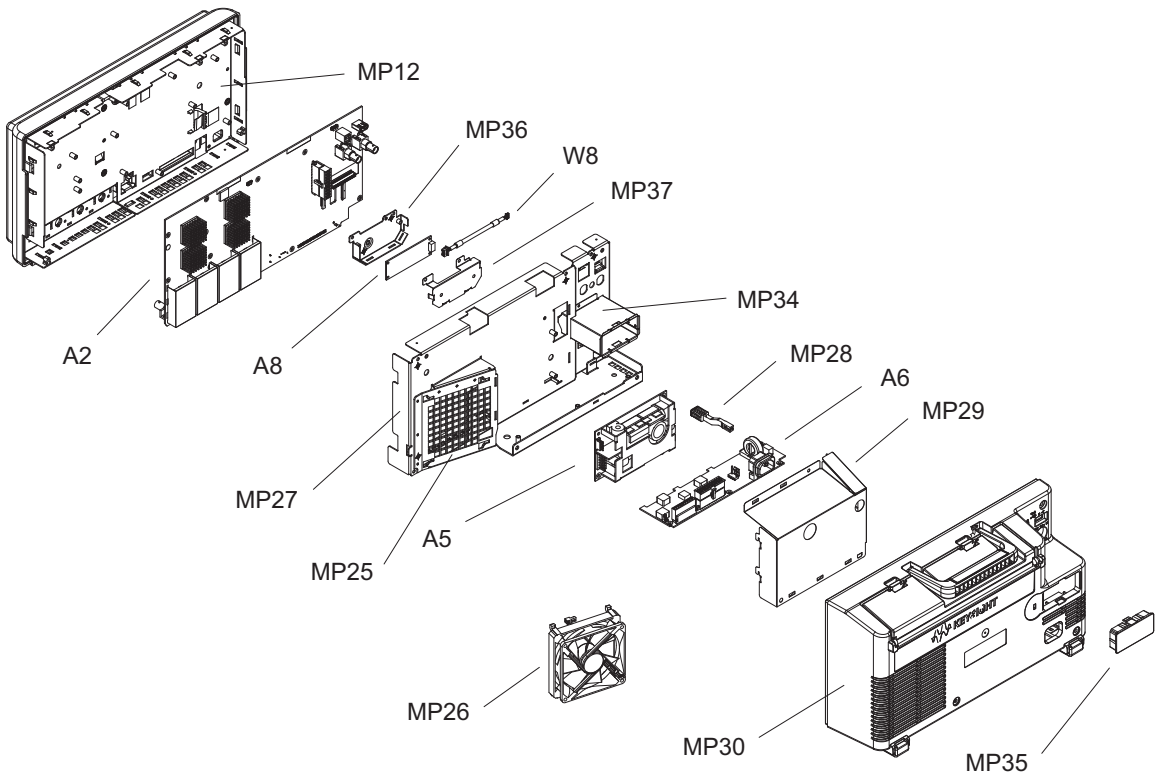

Figure 68 Exploded View 2 of 2

Replaceable Parts List

The information given for each part consists of the following:

- Reference designation.
- Keysight Technologies part number.
- Total quantity (Qty) in the instrument or on assembly.
- Description of the part.

Table 16 Replaceable Parts

Ref Des	Keysight Part Number	Qty	Description
A2	75032-66601	1	Acquisition board 3000T X-Series 2-Ch - 100, 200 MHz
A2	75032-69501	1	Acquisition board 3000T X-Series 2-Ch - 100, 200 MHz (exchange)
A2	75033-66601	1	Acquisition board 3000T X-Series 4-Ch - 100, 200 MHz
A2	75033-69501	1	Acquisition board 3000T X-Series 4-Ch - 100, 200 MHz (exchange)
A2	75034-66601	1	Acquisition board 3000T X-Series 2-Ch - 350, 500 MHz
A2	75034-69501	1	Acquisition board 3000T X-Series 2-Ch - 350, 500 MHz (exchange)
A2	75035-66601	1	Acquisition board 3000T X-Series 4-Ch - 350, 500 MHz
A2	75035-69501	1	Acquisition board 3000T X-Series 4-Ch - 350, 500 MHz (exchange)
A2	75036-66601	1	Acquisition board 3000T X-Series 2-Ch - 1 GHz
A2	75036-69501	1	Acquisition board 3000T X-Series 2-Ch - 1 GHz (exchange)
A2	75037-66601	1	Acquisition board 3000T X-Series 4-Ch - 1 GHz
A2	75037-69501	1	Acquisition board 3000T X-Series 4-Ch - 1 GHz (exchange)
A3	75037-66422	1	PCA - 2 Channel Keyboard 3000T X-Series
A3	75037-66423	1	PCA - 4 Channel Keyboard 3000T X-Series
A4	75015-66427	1	PCA - Keyboard Entry Softkey Board
A5	0950-5277	1	Power Supply Switching AC/DC 125W
A6	75019-66424	1	PCA - Line Filter Board

Table 16 Replaceable Parts (continued)

Ref Des	Keysight Part Number	Qty	Description
A7	75037-68703	1	Display assembly.
A8	75037-66425	1	Touch Screen Controller Board
H2	54684-42202	2	Hole plug front panel (2 Channel only, not shown)
H5	2950-0054	3	Nut, 1/2-28 THD (secures BNCs, not shown)
H11	2190-0068	3	Washer-LK Intl T 1/2 In. .505 IN-ID (for BNCs, not shown)
H3	0515-0374	37	Screw-Machine with Crest-Cup-Con-Washer Pan-HD Torx-T10 M3X0.5 10mm-LG SST-300 Passivated (not shown)
H4	0515-0658	4, 8	Screw-Machine w/Crest-Cup-Con-Wshr Pan-HD TORX-T6 M2X0.4 6mm-LG SST-300 Passivated (not shown, qty=4 for 2 Ch, qty=8 for 4 Ch)
H6	0515-0380	4	Screw-Machine W/Crest-Cup-Con-Washer Pan-HD Torx-T20 M4X0.7 10mm-LG SST-300 Passivated (not shown)
H7	0515-1753	3	Screw-Machine with Patch-Lock Pan-HD Torx-T10 M3X0.5 8mm-LG SST-300 Passivated (not shown)
H8	0515-0375	1	Screw-Machine W/Crest-Cup-Con-Washer Pan-HD Torx-T10 M3X0.5 16mm-LG SST-300 Passivated (not shown)
MP1	75032-94301	1	ID Label DSO-X 3012T
MP1	75032-94302	1	ID Label MSO-X 3012T
MP1	75032-94303	1	ID Label DSO-X 3022T
MP1	75032-94304	1	ID Label MSO-X 3022T
MP1	75033-94301	1	ID Label DSO-X 3014T
MP1	75033-94302	1	ID Label MSO-X 3014T
MP1	75033-94303	1	ID Label DSO-X 3024T
MP1	75033-94304	1	ID Label MSO-X 3024T
MP1	75034-94301	1	ID Label DSO-X 3032T
MP1	75034-94302	1	ID Label MSO-X 3032T
MP1	75034-94303	1	ID Label DSO-X 3052T

Table 16 Replaceable Parts (continued)

Ref Des	Keysight Part Number	Qty	Description
MP1	75034-94304	1	ID Label MSO-X 3052T
MP1	75035-94301	1	ID Label DSO-X 3034T
MP1	75035-94302	1	ID Label MSO-X 3034T
MP1	75035-94303	1	ID Label DSO-X 3054T
MP1	75035-94304	1	ID Label MSO-X 3054T
MP1	75036-94301	1	ID Label DSO-X 3102T
MP1	75036-94302	1	ID Label MSO-X 3102T
MP1	75037-94301	1	ID Label DSO-X 3104T
MP1	75037-94302	1	ID Label MSO-X 3104T
MP2	75019-94340	1	BNC Label 2 Channel
MP2	75019-94341	1	BNC Label 4 Channel
MP3	75019-47401	5	Large Rotary Knob
MP4	75019-47402	10	Small Rotary Knob
MP6	75037-94303	1	Front Keyboard Label 2 Channel
MP6	75037-94304	1	Front Keyboard Label 4 Channel
MP7	75037-60201	1	Panel Bezel Assembly
MP8	75037-41901	1	Keyboard Keypad
MP9	75019-41902	1	Softkey Keypad
MP12	75019-00101	1	Front Deck
MP14	75019-47103	1	Cable Guide

Table 16 Replaceable Parts (continued)

Ref Des	Keysight Part Number	Qty	Description
MP27	75019-00102	1	Rear Deck
MP25	75019-44701	1	Fan Mount
MP26	3160-4343	1	Fan
MP28	75019-43901	1	Extender, Power Switch
MP29	75019-00602	1	Power Supply Shield
MP30	75019-64401	1	Cabinet (Bucket) Assembly
MP33	75037-94306	*	Overlay - Traditional Chinese, 4 channel
MP33	75037-94305	*	Overlay - Traditional Chinese, 2 channel
MP33	75037-94308	*	Overlay - Korean, 4 channel
MP33	75037-94307	*	Overlay - Korean, 2 channel
MP33	75037-94310	*	Overlay - Simplified Chinese, 4 channel
MP33	75037-94309	*	Overlay - Simplified Chinese, 2 channel
MP33	75037-94311	*	Overlay - Thai, 4 channel
MP33	75037-94312	*	Overlay - Thai, 2 channel
MP33	75037-94314	*	Overlay - Turkish, 4 channel
MP33	75037-94313	*	Overlay - Turkish, 2 channel
MP33	75037-94316	*	Overlay - Portuguese, 4 channel
MP33	75037-94315	*	Overlay - Portuguese, 2 channel
MP33	75037-94318	*	Overlay - German, 4 channel
MP33	75037-94317	*	Overlay - German, 2 channel
MP33	75037-94320	*	Overlay - Spanish, 4 channel
MP33	75037-94319	*	Overlay - Spanish, 2 channel

Table 16 Replaceable Parts (continued)

Ref Des	Keysight Part Number	Qty	Description
MP33	75037-94322	*	Overlay - French, 4 channel
MP33	75037-94321	*	Overlay - French, 2 channel
MP33	75037-94324	*	Overlay - Japanese, 4 channel
MP33	75037-94323	*	Overlay - Japanese, 2 channel
MP33	75037-94326	*	Overlay - Italian, 4 channel
MP33	75037-94325	*	Overlay - Italian, 2 channel
MP33	75037-94328	*	Overlay - Czech, 4 channel
MP33	75037-94327	*	Overlay - Czech, 2 channel
MP33	75037-94330	*	Overlay - Polish, 4 channel
MP33	75037-94329	*	Overlay - Polish, 2 channel
MP33	75037-94332	*	Overlay - Russian, 4 channel
MP33	75037-94331	*	Overlay - Russian, 2 channel
MP34	75019-00608	1	Guide - Option Module
MP35	75019-42203	1	Hole Plug - Option Module
MP36	75037-00101	1	Controller Board Bracket
MP37	75037-00601	1	Controller Board Shield
W5	75019-61602	1	Cable - DC
W7	75019-61603	1	Cable - AC
	75019-61604	1	Cable - Ground Wire
W4	75019-61605	1	Soft Keyboard Cable
W1	75019-61610	1	Cable - Display
W3	75019-61607	1	Keyboard Cable
	75019-61601	1	Cable Interboard Supply

Table 16 Replaceable Parts (continued)

Ref Des	Keysight Part Number	Qty	Description
W6	Power cord	0-1	Part number varies by country. Contact your local Keysight sales office for replacement.
W8	75037-61601	1	Touch Screen Cable
	N2843A	*	Passive Probe 10:1, 500 MHz
MP10	75019-44108	*	Protective Cover Assembly
Not shown	75019-68705	*	LAN Module
Not shown	75019-68706	*	GPIB Module
Not shown	N6456-60001	*	Rack Mount Kit for 3000T X-Series Oscilloscope

*Optional item.

7 Safety Notices

This apparatus has been designed and tested in accordance with IEC Publication 1010, Safety Requirements for Measuring Apparatus, and has been supplied in a safe condition. This is a Safety Class I instrument (provided with terminal for protective earthing). Before applying power, verify that the correct safety precautions are taken (see the following warnings). In addition, note the external markings on the instrument that are described under “Safety Symbols.”

Warnings

Before turning on the instrument, you must connect the protective earth terminal of the instrument to the protective conductor of the (mains) power cord. The mains plug shall only be inserted in a socket outlet provided with a protective earth contact. You must not negate the protective action by using an extension cord (power cable) without a protective conductor (grounding). Grounding one conductor of a two-conductor outlet is not sufficient protection.

Only fuses with the required rated current, voltage, and specified type (normal blow, time delay, etc.) should be used. Do not use repaired fuses or short-circuited fuseholders. To do so could cause a shock or fire hazard.

If you energize this instrument by an auto transformer (for voltage reduction or mains isolation), the common terminal must be connected to the earth terminal of the power source.

Whenever it is likely that the ground protection is impaired, you must make the instrument inoperative and secure it against any unintended operation.

Service instructions are for trained service personnel. To avoid dangerous electric shock, do not perform any service unless qualified to do so. Do not attempt internal service or adjustment unless another person, capable of rendering first aid and resuscitation, is present.

Do not install substitute parts or perform any unauthorized modification to the instrument.

Capacitors inside the instrument may retain a charge even if the instrument is disconnected from its source of supply.

Do not operate the instrument in the presence of flammable gasses or fumes. Operation of any electrical instrument in such an environment constitutes a definite safety hazard.

Do not use the instrument in a manner not specified by the manufacturer.

To clean the instrument

If the instrument requires cleaning: (1) Remove power from the instrument. (2) Clean the external surfaces of the instrument with a soft cloth dampened with a mixture of mild detergent and water. (3) Make sure that the instrument is completely dry before reconnecting it to a power source.

Safety Symbols



Instruction manual symbol: the product is marked with this symbol when it is necessary for you to refer to the instruction manual in order to protect against damage to the product.



Hazardous voltage symbol.



Earth terminal symbol: Used to indicate a circuit common connected to grounded chassis.

Index

A

- accuracy, DC vertical gain, 30
- accuracy, dual cursor, 35
- assemblies
 - exchange, 133
 - replacing, 87

B

- bandwidth
 - verification, 39

C

- cabinet, removing, 89
- calibration, 57
- cautions, 71, 73, 76, 88, 125
- certificate of calibration, 57
- channels
 - problem solving, 64
- cleaning the instrument, 144
- compensating your probe, 69
- connecting for threshold test, 28
- contact Keysight, 18

D

- DC vertical gain accuracy, 30
- digital channel
 - testing, 25
 - verification, 26
- digital channels, 4
- display
 - assembly removal, 113, 119
 - problem solving, 62
- dual cursor accuracy, 35

E

- equipment, test, 21
- exchange assemblies, 133

- exploded view
 - front panel, 134
 - instrument, 135

F

- fan assembly removal, 121
- front panel
 - exploded view, 134
 - removal, 95
- front panel self test, 66

H

- hardware self test, 65

I

- internal self-tests, 65

K

- keyboard, removal, 107
- Keysight
 - contact information, 18

L

- LED, startup sequence, 65
- lid, removal, 90
- line filter board removal, 126

M

- making test connector, 23
- measurement category, 16
 - definitions, 16

N

- NIST, 57

O

- ordering parts, 132
- overvoltage category, 18

P

- parts
 - list, 136
 - ordering, 132
- passive probe, 141
- perform user cal, 57
- performance
 - test record, 52
- pollution degree, 18
- pollution degree, definitions, 18
- power
 - cord list, 141
 - supply removal, 123
 - supply shield, removal, 92
 - test points, 74, 75
- power requirements, 15
- probe
 - N2862B, 141
- probes
 - compensating, 69
 - problem solving, 61

R

- record tests, 52
- remove, 126
 - cabinet, 89
 - display assembly, 113, 119
 - fan assembly, 121
 - front panel, 95
 - keyboard, 107
 - power supply, 123
 - power supply shield, 92
 - storage lid, 90
- replaceable parts list, 136
- replacing assemblies, 87

Index

run self-tests, 65

S

safety notice, 56, 70
self test, front panel, 66
self test, hardware, 65
self-alignment, user cal, 57
self-tests, 65
specifications, 18
startup sequence, 65
status, User Cal, 60
status, user cal, 57
storage lid, removal, 90

T

test

- connector, constructing, 23
- digital channels, 25
- equipment, 21
- points, power, 74, 75
- record, 52

threshold

- accuracy, digital channel, 26
- test diagram, 28

trace display

- problem solving, 63

transient withstand capability, 17

trigger

- sensitivity, 46
- sensitivity, external, 49
- sensitivity, internal, 46

troubleshooting, 61

- equipment required, 70
- fan, 84
- flowchart, 73
- power supply, 76

U

user calibration, 57

V

verify

- bandwidth, 39
- digital channel, 26
- trigger, 46

W

warnings, 88

warranted specifications, 18