

FLUKE®

Calibration

5730A

Multifunction Calibrator

Operators Manual

LIMITED WARRANTY AND LIMITATION OF LIABILITY

Each Fluke product is warranted to be free from defects in material and workmanship under normal use and service. The warranty period is one year and begins on the date of shipment. Parts, product repairs, and services are warranted for 90 days. This warranty extends only to the original buyer or end-user customer of a Fluke authorized reseller, and does not apply to fuses, disposable batteries, or to any product which, in Fluke's opinion, has been misused, altered, neglected, contaminated, or damaged by accident or abnormal conditions of operation or handling. Fluke warrants that software will operate substantially in accordance with its functional specifications for 90 days and that it has been properly recorded on non-defective media. Fluke does not warrant that software will be error free or operate without interruption.

Fluke authorized resellers shall extend this warranty on new and unused products to end-user customers only but have no authority to extend a greater or different warranty on behalf of Fluke. Warranty support is available only if product is purchased through a Fluke authorized sales outlet or Buyer has paid the applicable international price. Fluke reserves the right to invoice Buyer for importation costs of repair/replacement parts when product purchased in one country is submitted for repair in another country.

Fluke's warranty obligation is limited, at Fluke's option, to refund of the purchase price, free of charge repair, or replacement of a defective product which is returned to a Fluke authorized service center within the warranty period.

To obtain warranty service, contact your nearest Fluke authorized service center to obtain return authorization information, then send the product to that service center, with a description of the difficulty, postage and insurance prepaid (FOB Destination). Fluke assumes no risk for damage in transit. Following warranty repair, the product will be returned to Buyer, transportation prepaid (FOB Destination). If Fluke determines that failure was caused by neglect, misuse, contamination, alteration, accident, or abnormal condition of operation or handling, including overvoltage failures caused by use outside the product's specified rating, or normal wear and tear of mechanical components, Fluke will provide an estimate of repair costs and obtain authorization before commencing the work. Following repair, the product will be returned to the Buyer transportation prepaid and the Buyer will be billed for the repair and return transportation charges (FOB Shipping Point).

THIS WARRANTY IS BUYER'S SOLE AND EXCLUSIVE REMEDY AND IS IN LIEU OF ALL OTHER WARRANTIES, EXPRESS OR IMPLIED, INCLUDING BUT NOT LIMITED TO ANY IMPLIED WARRANTY OF MERCHANTABILITY OR FITNESS FOR A PARTICULAR PURPOSE. FLUKE SHALL NOT BE LIABLE FOR ANY SPECIAL, INDIRECT, INCIDENTAL, OR CONSEQUENTIAL DAMAGES OR LOSSES, INCLUDING LOSS OF DATA, ARISING FROM ANY CAUSE OR THEORY.

Since some countries or states do not allow limitation of the term of an implied warranty, or exclusion or limitation of incidental or consequential damages, the limitations and exclusions of this warranty may not apply to every buyer. If any provision of this Warranty is held invalid or unenforceable by a court or other decision-maker of competent jurisdiction, such holding will not affect the validity or enforceability of any other provision.

Fluke Corporation
P.O. Box 9090
Everett, WA 98206-9090
U.S.A.

Fluke Europe B.V.
P.O. Box 1186
5602 BD Eindhoven
The Netherlands

OPERATOR SAFETY SUMMARY

WARNING

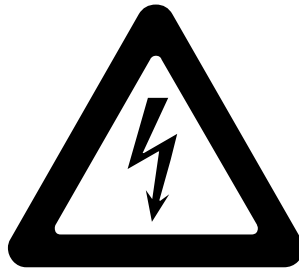

HIGH VOLTAGE

is used in the operation of this equipment

LETHAL VOLTAGE

may be present on the terminals, observe all safety precautions!

To prevent electrical shock hazard, the operator should not electrically contact the output HI or sense HI terminals or circuits connected to these terminals. During operation, lethal voltages of up to 1100 V ac or dc may be present on these terminals.

When the nature of the operation permits, keep one hand away from equipment to reduce the hazard of current flowing through vital organs of the body.

Table of Contents

Chapter	Title	Page
1	Introduction and Specification.....	1-1
	Introduction.....	1-1
	Safety Information	1-3
	Symbols	1-4
	How to Contact Fluke Calibration	1-5
	Instruction Manuals	1-5
	Wideband AC Voltage Module (Option 5730A/03 or 5730A/05).....	1-6
	Auxiliary Amplifiers.....	1-6
	5725A Amplifier	1-7
	52120A Amplifier	1-7
	Support Equipment and Services	1-7
	732B Direct Voltage Reference Standard	1-8
	732B-200 Direct Volt Maintenance Program (USA Only)	1-8
	742A Series Resistance Standards.....	1-8
	Wideband AC Module (Option 5730A/03 or 5730A/05)	
	Calibration Support	1-8
	The Components of the Calibrator.....	1-9
	Specifications.....	1-9
	Specification Confidence Levels	1-9
	Use of Absolute and Relative Accuracy Specifications	1-10
	Use of Secondary Performance Specifications.....	1-10
	General Specifications	1-11
	Electrical Specifications	1-13
	AC Voltage Specifications	1-14
	Resistance Specifications	1-20
	DC Current Specifications.....	1-23
	AC Current Specifications.....	1-24
	Wideband AC Voltage (Option 5730A/03 and 5730A/05)	
	Specifications (99 % Confidence Level).....	1-27
	52120A Specifications when Operated with the 5730A.....	1-28
	52120A Electrical Performance Limits	1-28
	Operated within 5730A Control Loop (all current ranges)	1-29
	Coverage factor k=2.58 (99 % confidence level).....	1-29
	Coverage factor k=2.00 (95 % confidence level).....	1-29

	52120A/COIL 3 kA 25-Turn Coil	1-30
	52120A/COIL 6 kA 50-Turn Coil	1-31
2	Installation	2-1
	Introduction.....	2-1
	Unpack and Inspect the Calibrator.....	2-1
	Placement and Rack Mounting	2-2
	Cooling Considerations.....	2-2
	Mains Voltage Selection	2-3
	Connect to Mains Power.....	2-4
	Connect a 5725A Amplifier.....	2-4
	Connect a 52120A Amplifier.....	2-4
3	Features	3-1
	Introduction.....	3-1
	Front-Panel Features	3-1
	Rear-Panel Features	3-5
4	Front-Panel Operation	4-1
	Introduction.....	4-1
	Turn on the Calibrator.....	4-2
	Warmup	4-2
	Product Use.....	4-2
	Reset the Calibrator	4-3
	Operate and Standby Modes	4-3
	Connect the Calibrator to a UUT	4-4
	Recommended Cable and Connector Types.....	4-4
	When to Use External Sensing	4-6
	When to Use the External Voltage Guard	4-6
	Four-Wire Vs. Two-Wire Resistance Connections	4-6
	Cable Connection Instructions.....	4-7
	Set the Output	4-14
	DC Voltage Output.....	4-16
	AC Voltage Output.....	4-17
	DC Current Output	4-19
	AC Current Output	4-21
	Resistance Output.....	4-23
	Wideband AC Voltage Output (Option 5730A/03 or 5730A/05)	4-26
	Variable Phase Output	4-28
	Phase Locking to an External Signal	4-29
	Auxiliary Amplifier Use	4-30
	5725A Amplifier Output	4-31
	52120A Transconductance Amplifier Output	4-32
	Error Mode Operation.....	4-32
	Error Mode Overview.....	4-33
	Enter Error Mode	4-33
	Exit Error Mode	4-33
	Use Error Mode.....	4-34
	Read the UUT Error: AC and DC Voltage and Current Output.....	4-34
	Read the UUT Error: Resistance Output	4-35
	Introduction to Offset, Scale, and Linearity Errors.....	4-35
	Offset Error.....	4-36
	Scale Error	4-36
	Linearity Error	4-37

Combine the Error Types	4-38
Program an Offset.....	4-39
Program a Scale Factor	4-40
Linearity Check with Offset and Scale	4-41
Set up the Calibrator	4-45
Setup Menu.....	4-45
Setup Menu Rules.....	4-46
Menu Description	4-47
Touchscreen Selections	4-47
Instrument Setup	4-51
Uncertainty Information Menu.....	4-52
Set Output Limits	4-53
Select Boost Amplifiers.....	4-54
Error Reference	4-54
Instrument Settings	4-56
Set the Internal Clock/Calendar.....	4-56
Language	4-57
Display Brightness.....	4-57
About This Instrument.....	4-57
5 Remote Interface Setup	5-1
GPIB (IEEE-488) Interface.....	5-2
Use the IEEE-488 Port for Remote Control	5-2
IEEE-488 Bus Restrictions.....	5-2
Bus Setup Procedure.....	5-2
IEEE-488 Interface Configuration.....	5-3
Bus Communication Overview	5-3
RS-232 Serial Interface.....	5-4
Use the RS-232 Port for Remote Control.....	5-4
RS-232 Interface Specifications	5-4
Set Up and Connect the Serial Interface.....	5-5
Serial Remote Control Setup Procedure	5-6
Exceptions for Serial Remote Control.....	5-6
Ethernet Interface.....	5-7
Set Up and Connect the Ethernet Interface	5-7
Set the IP Address	5-7
Select the Dynamic Host Configuration Protocol (DHCP)	5-7
Set a Static Internet Address.....	5-8
Configure the General Network Socket Port.....	5-8
Configure the LAN Default Gateway.....	5-9
Set the LAN Subnet Mask	5-9
Read the MAC Address.....	5-9
Establish an Ethernet Connection	5-10
Terminate an Ethernet Connection	5-10
Use of Ethernet Remote Control	5-10
Use of USB 2.0 Remote Control.....	5-11
6 Remote Commands and Syntax.....	6-1
Introduction.....	6-1
Parameter Syntax Rules.....	6-1
Extra Space Characters	6-2
Terminators.....	6-2
Incoming Character Processing.....	6-3
Response Message Syntax.....	6-3

Input Buffer Operation.....	6-3
Commands	6-4
Multiple Commands	6-4
Coupled Commands	6-4
Sequential and Overlapped Commands.....	6-5
Commands Ignored When Not in Remote	6-5
Commands that Require the Calibration Security Passcode.....	6-5
Long Term Commands.....	6-5
Definition: Queries and Commands	6-6
Functional Elements of Commands.....	6-6
Interface Messages (IEEE-488 Only).....	6-8
Use of *OPC?, *OPC, and *WAI.....	6-10
Local-to-Remote State Transitions	6-48
Check the Calibrator Status	6-50
Status Byte Register	6-52
Service Request Line (SRQ)	6-52
Service Request Enable Register.....	6-52
Load the SRE	6-52
Event Status Register.....	6-53
Bit Assignments for the ESR and ESE.....	6-53
Read the ESR and ESE	6-54
Load the ESE.....	6-54
Instrument Status Register.....	6-54
Instrument Status Change Register.....	6-54
Instrument Status Change Enable Register	6-54
Bit Assignments for the ISR, ISCR, and ISCE	6-54
Read the ISR, ISCR, or ISCE.....	6-55
Load the ISCE	6-55
Fault Queue	6-55

7 Operator Maintenance and Calibration 7-1

Introduction.....	7-1
Fuse Replacement	7-1
Clean the Air Filter	7-3
Clean the Exterior	7-4
User-Replaceable Parts	7-4
5730A Calibration.....	7-6
The Artifact Calibration Process	7-6
Establish Traceability	7-7
Calibration Reports.....	7-7
Range Adjustment	7-7
DC Zeros.....	7-7
Run DC Zeros	7-7
DC Zeros Reminder.....	7-8
Calibration	7-8
Calibration Security Passcode	7-9
Artifact Calibration.....	7-9
When to Adjust Calibrator Accuracy	7-10
Calibration Procedure	7-10
Range Adjustment.....	7-13
Calibrate the Wideband AC Module (Option 5730A/03 or 5730A/05).....	7-17
Wideband Flatness Calibration Procedure.....	7-18
Calibration Check	7-20
Develop a Performance History	7-21
Save Calibration Reports	7-21

Calibration Shift Results.....	7-22
Calibration Check Shift Results	7-23
Raw Data Results	7-23
8 Options and Accessories	8-1
Introduction.....	8-1
Wideband AC Voltage Module (Option 5730A/03 or 5730A/05).....	8-1
Accessories	8-1
Low Thermal EMF Test Leads.....	8-2
Rack Mount Kits.....	8-3
Shielded IEEE-488 Interface Cables (Y8021 and Y8022).....	8-3
DC Voltage Reference Standard (732B)	8-3
1 Ω and 10 k Ω Resistance Standards (742A-1 and 742A-10k).....	8-3
5725A Amplifier	8-4
52120A Amplifier	8-4
Appendices	
A Fault Codes.....	A-1
B ASCII and IEEE-488 Bus Codes.....	B-1
C Glossary.....	C-1

List of Tables

Table	Title	Page
1-1.	Symbols.....	1-4
1-2.	Auxiliary Amplifier Data	1-6
2-1.	Standard Equipment	2-2
2-2.	Line Power Cord Types Available from Fluke Calibration	2-3
3-1.	Front-Panel Features	3-2
3-2.	Rear-Panel Features	3-5
4-1.	Auxiliary Amplifier Data	4-5
4-2.	UUT Connection Figures	4-7
4-3.	Sections of the Display.....	4-14
4-4.	Keys that Exit Error Mode	4-33
5-1.	Supported IEEE-488 Interface Function Subsets.....	5-3
5-2.	RS-232 Interface Parameter Choices	5-4
6-1.	Functional Elements of Commands	6-7
6-2.	Interface Messages Accepted by the Calibrator	6-8
6-3.	Interface Messages Sent by the Calibrator	6-9
6-4.	Command Summary by Function	6-11
6-5.	Commands.....	6-16
6-6.	Serial Remote Control Commands.....	6-47
6-7.	Range Identifiers for Remote Commands.....	6-47
6-8.	Operating State Transitions	6-49
6-9.	Status Register Summary	6-50
7-1.	Replacement Fuses.....	7-1
7-2.	User-Replaceable Parts	7-4
7-3.	Standards for Calibration	7-10
8-1.	Accessories.....	8-2

List of Figures

Figure	Title	Page
2-1.	Available Mains Power Cord Types	2-3
2-2.	Line Power Label and Switch Location	2-4
3-1.	Front-Panel Features	3-1
3-2.	Rear-Panel Features	3-5
4-1.	UUT Connections: DC Voltage, AC Voltage ≤ 10 kHz	4-8
4-2.	UUT Connections: AC Voltage > 10 kHz	4-9
4-3.	UUT Connections: AC Current ≤ 2 A	4-10
4-4.	UUT Connections: Resistance	4-11
4-5.	UUT Wideband AC Voltage Output (5730A/03 Option)	4-13
4-6.	UUT Connections: 5725A Amplified Current Output	4-13
4-7.	Offset Error	4-36
4-8.	Scale Error	4-37
4-9.	Linearity Error	4-38
4-10.	Meter Response vs. Stimulus	4-41
6-1.	Overview of Status Data Structure	6-51
7-1.	Access the Fuse	7-2
7-2.	Air Filter Access	7-3
7-3.	Replaceable Parts	7-5
7-4.	732B External Calibration Connections	7-11
7-5.	742A-1 and 742A-10k External Calibration Connections	7-12
7-6.	220 V DC Range Calibration Connections	7-16
7-7.	Wideband Module Calibration Connection	7-17
7-8.	Wideband Flatness Calibration Connections	7-18

Chapter 1

Introduction and Specification

Introduction

The Fluke Calibration 5730A Calibrator (the “Calibrator” or the “Product”) can calibrate a wide variety of electrical measurement instruments. The 5730A Calibrator maintains a high accuracy over a wide ambient temperature range. This accuracy lets the Calibrator test instruments in any environment, and eliminates the restrictions to calibrate only in a temperature-controlled standards laboratory. The Calibrator can calibrate precision multimeters that measure ac or dc voltage, ac or dc current, and resistance. The Calibrator also is available with a Wideband AC Voltage option which extends this workload to include RF voltmeters.

Specifications are provided at the end of this chapter. The 5730A Calibrator is a fully-programmable precision source of:

- DC voltage to 1100 V
- AC voltage to 1100 V, with output available from 10 Hz to 1.2 MHz
- AC and DC current to 2.2 A, with output available from 10 Hz to 10 kHz
- Resistance in values from 1 Ω to 100 M Ω , plus a short
- Optional wideband ac voltage from 300 μ V to 3.5 V into 50 Ω (-57 dBm to +24 dBm), 10 Hz to 30 MHz (5730A/03) or 50 MHz (5730A/05)

Features of the 5730A Calibrator include:

- Internal environmentally-controlled references that let the Calibrator maintain full performance over a wide ambient temperature range.
- Automatic meter error calculation obtained through the use of a simple output adjust knob.
- Keys that multiply and divide the output value by 10. This simplifies work on meters with calibration points at decade multiples of a fraction of full-scale.
- Programmable entry limits used to restrict the levels that can be entered into the Calibrator. This prevents access to levels that may be harmful to equipment or personnel.

- Continuous display of Calibrator specifications at the selected operation point, calibration interval, and specification confidence level.
- An auxiliary current binding post to calibrate meters with separate current inputs without the need to move cables.
- Real-time clock and calendar for date stamping reports and reminders issued to perform the dc zeros calibration procedure within the required interval.
- Offset and scaling modes that simplify linearity tests of multimeters.
- Variable phase reference signal output and phase-lock input.
- Interface for the Fluke Calibration 5725A Amplifier.
- Interface for the Fluke Calibration 52120A Amplifier.
- Standard IEEE-488 (GPIB) interface, that complies with ANSI/IEEE Standards 488.1-1987 and 488.2-1987.
- EIA/TIA-574 Standard RS-232 serial data interface for remote control of the Calibrator.
- Universal Serial Bus (USB) 2.0 high-speed interface device port for remote control of the Calibrator.
- Integrated 10/100/1000BASE-T Ethernet port for network connection remote control of the Calibrator.
- Extensive internal self-testing and diagnostics of analog and digital functions
- USB Host port to save calibration reports to a flash drive.
- Visual Connection Management output terminals illuminate to help show correct cable connection configurations.
- Soft Power - automatic selection of line voltage/frequency.
- LCD Color VGA display with touch panel overlay.
- A traceable calibration procedure for all modes and ranges that requires only 10 V, 1 Ω , and 10 k Ω external standards, with only occasional independent verification.
- Automated calibration check that provides added confidence between calibration recalls, and data that can be used to document and characterize Calibrator performance between calibration recalls.

Safety Information

A **Warning** identifies conditions and procedures that are dangerous to the user. A **Caution** identifies conditions and procedures that can cause damage to the Product or the equipment under test.

Warnings

To prevent possible electrical shock, fire, or personal injury:







- Read all safety information before you use the Product.
- Carefully read all instructions.
- Do not use the Product around explosive gas, vapor, or in damp or wet environments.
- Use this Product indoors only.
- Do not put the Product where access to the mains power cord is blocked.
- Use only the mains power cord and connector approved for the voltage and plug configuration in your country and rated for the Product.
- Replace the mains power cord if the insulation is damaged or if the insulation shows signs of wear.
- Make sure the ground conductor in the mains power cord is connected to a protective earth ground. Disruption of the protective earth could put voltage on the chassis that could cause death.
- Do not use an extension cord or adapter plug.
- Do not operate the Product with covers removed or the case open. Hazardous voltage exposure is possible.
- Do not use the Product if it operates incorrectly.
- Do not connect to live output terminals. The Product can supply voltages that can cause death. Standby mode is not sufficient to prevent electrical shock.
- Do not apply more than the rated voltage, between the terminals or between each terminal and earth ground.
- Use only cables with correct voltage ratings.

- Do not touch exposed metal on banana plugs, they can have voltages that could cause death.
- Do not touch voltages >30 V ac rms, 42 V ac peak, or 60 V dc.
- Use the Product only as specified, or the protection supplied by the Product can be compromised.
- Use only specified replacement fuses.
- Have an approved technician repair the Product.

Symbols

The symbols shown in Table 1-1 can be found in this manual or on the Calibrator.

Table 1-1. Symbols

Symbol	Definition	Symbol	Definition
	WARNING. RISK OF DANGER.		WARNING. HAZARDOUS VOLTAGE. Risk of electric shock.
	This product complies with the WEEE Directive marking requirements. The affixed label indicates that you must not discard this electrical/electronic product in domestic household waste. Product Category: With reference to the equipment types in the WEEE Directive Annex I, this product is classed as category 9 "Monitoring and Control Instrumentation" product. Do not dispose of this product as unsorted municipal waste.		Conforms to European Union directives.
	Certified by CSA Group to North American safety standards.		Conforms to relevant Australian EMC standards.
	Conforms to relevant South Korean EMC Standards.		

How to Contact Fluke Calibration

To contact Fluke Calibration, call one of the following telephone numbers:

- Technical Support USA: 1-877-355-3225
- Calibration/Repair USA: 1-877-355-3225
- Canada: 1-800-36-FLUKE (1-800-363-5853)
- Europe: +31-40-2675-200
- Japan: +81-3-6714-3114
- Singapore: +65-6799-5566
- China: +86-400-810-3435
- Brazil: +55-11-3759-7600
- Anywhere in the world: +1-425-446-6110

To see product information or download manuals and the latest manual supplements, visit Fluke Calibration's website at www.flukecal.com.

To register your product, visit <http://flukecal.com/register-product>.

Instruction Manuals

The 5730A Calibrator ships with:

- *5730A Getting Started*
- *5730A Operators Manual* (provided on CD-ROM or a printed copy is available for purchase through the Fluke Calibration Service Department)

To order, refer to the Fluke Calibration Catalog or contact a Fluke Calibration sales representative. See "How to Contact Fluke Calibration".

This manual provides complete information to install and operate the 5730A Calibrator from the front panel or with remote commands. It also provides a glossary of calibration-related terms as well as general items such as specifications and error code information.

Wideband AC Voltage Module (Option 5730A/03 or 5730A/05)

The Wideband AC Voltage Module (Option 5730A/03 or 5730A/05) can be installed in the 5730A Calibrator. The module is a high-accuracy, low-noise, extremely flat ac voltage source to calibrate RF voltmeters, with a frequency range of 10 Hz to 30 MHz (5730A/03) or 50 MHz (5730A/05). Output is in seven ranges from 300 μ V (-57 dBm) to 3.5 V (+24 dBm) through a Type-N coaxial connector into a 50 Ω load. The output level is selected in volts or dBm through either the front panel controls or under remote control.

The wideband module also functions with the Calibrator output adjust controls that display the error of a wideband meter in either percentage of output or in decibels.

Included with the wideband module is a Type-N output cable, a 50 Ω terminator, an N(f) to BNC(m) adapter, and a BNC(f) to double banana plug adapter. The wideband module is calibrated to the end of its standard-equipment output cable.

Auxiliary Amplifiers

The Fluke Calibration Model 5725A and 52120A amplifiers are available to extend the high voltage performance and current range of the 5730A Calibrator.

Interface connectors on the Calibrator rear panel accept cables to directly operate a 5725A and/or 52120A. Multiple amplifiers can be connected to the Calibrator at the same time, but only one output can be active at a time. Once the amplifiers are connected and configured in the Product Setup Menu, amplifier operation is controlled by the Calibrator.

A maximum of three 52120As can be connected to provide a maximum of 360 A rms ac or 300 A dc current when their outputs are connected in parallel.

See Chapter 4 for instructions to operate both amplifiers. The general specifications at the end of this chapter include specifications to operate the 5730A Calibrator with both amplifiers. For other amplifier specifications, refer to their instruction manuals. Table 1-2 summarizes the extended capabilities offered by the 5725A and 52120A. Brief descriptions of the extended capabilities follow.

Table 1-2. Auxiliary Amplifier Data

Model	Mode	Range
5725A Amplifier	AC Volts	20 V rms to 1100 V rms up to 70 mA, 40 Hz to 30 kHz (50 mA < 5 kHz) 220 V rms to 750 V rms up to 70 mA, 30 kHz to 100 kHz
	DC Amps	0 A to \pm 11 A
	AC Amps	1 A rms to 11 A rms, 40 Hz to 10 kHz
52120A Transconductance Amplifier ^[1]	DC Amps	0 A to \pm 100 A
	AC Amps	0.2 A rms to 120 A rms, 10 Hz to 10 kHz
[1] Up to three 52120As may be connected, providing a total current of up to 300 A dc or 360 A rms.		

5725A Amplifier

The Fluke Calibration 5725A Amplifier is an external unit that operates under calibrator control. It extends ac voltage drive capabilities and both ac and dc current output range. The amplifier adds these capabilities to the 1100 V ac range of the 5730A Calibrator with no compromise in accuracy:

- Frequency limits at higher voltage increase to 100 kHz at 750 V, 30 kHz at 1100 V.
- Load limit increases to 70 mA for frequencies above 5 kHz.
- Capacitive drive increases to 1000 pF, subject to the maximum output current.

A separate set of binding posts on the front panel of the 5725A supplies extended-range ac and dc current outputs. Since most meters have a separate input terminal for the high-current ranges, this eliminates the need to change cables during a procedure. The 5725A can also be configured to source all current (both standard calibrator-generated current and its own current) through the 5725A binding posts.

52120A Amplifier

The Fluke Calibration 52120A Transconductance Amplifier is an external unit that operates under calibrator control to extend the ac and dc current output range of the 5730A Calibrator. A maximum of three 52120A amplifiers can be connected, as much as tripling the current output available. The 52120A amplifier can:

- Accept full scale dc or ac inputs of 2 volts or 200 mA from any calibrator, signal generator or power supply
- Deliver proportional output current in ranges of 2 A, 20 A or 120 A at frequencies to 10 kHz
- Offer enhanced accuracy to 140 ppm when used in closed-loop mode with a 6105A Electrical Power Standard
- Operate in parallel with one or two other 52120As to deliver 240 A or 360 A
- Source current with compliance voltage of 4.5 V rms or 6.4 V peak
- Drive inductive loads to 1 mH
- Drive optional current coils to deliver test currents of 3000 A or 6000 A

Support Equipment and Services

Fluke Calibration supports calibration requirements with precision, high-quality equipment and a wide range of services. Depending on the calibration needs, location, and capabilities, the 5730A Calibrator can be supported independently or with Fluke Calibration services for part, or all support needs. The subsequent paragraphs describe the support equipment and services offered by Fluke Calibration for the Calibrator. For specifications and ordering instructions for this support equipment and other Fluke Calibration instruments, refer to the Fluke Calibration catalog, or contact a representative at a Fluke Calibration Sales and Service Center. See “How to Contact Fluke Calibration”.

732B Direct Voltage Reference Standard

The Fluke Calibration 732B is a rugged, easily transported solid state direct voltage reference standard with a highly predictable 10 V output. The 732B can be short-circuited, even for extended periods of time, without damage or loss of stability. It maintains full specified stability over a temperature span of 18 °C to 28 °C.

The 5730A Calibrator uses a 10 V reference standard such as the Fluke Calibration 732B in its semi-automated calibration procedure to establish external voltage traceability. Chapter 7 describes this procedure.

732B-200 Direct Volt Maintenance Program (USA Only)

The Fluke Calibration 732B-200 Direct Volt Maintenance Program provides laboratories with NIST-traceable 10 V calibration uncertainty as low as 0.6 parts per million (ppm).

The program maintains the 732B that is kept in the laboratory. To do this:

1. Fluke Calibration sends a calibrated Fluke Calibration-owned 732B standard, together with all-necessary connection cables and instructions for comparison with a customer 10 V reference standard.
2. The customer takes a series of readings over five days, and returns the results to the Fluke Calibration Standards Laboratory.
3. The Fluke Calibration Standards Laboratory assigns a value to the customer 10 V standard relative to the NIST legal volt and sends a report of calibration.

742A Series Resistance Standards

The 5730A Calibrator uses 1 Ω and 10 k Ω resistor standards such as the 742A Series in its semi-automated calibration procedure to establish external traceability of resistance and current. Chapter 7 describes this procedure.

The 742A Resistance Standards are constructed of arrays of Fluke Calibration wirewound precision resistors and are ideally suited as support standards for the Calibrator. Stability of the resistance transfer standards and their temperature coefficients make them ideal for easy transport to the Calibrator work environment.

Wideband AC Module (Option 5730A/03 or 5730A/05) Calibration Support

The Wideband AC Module (Option 5730A/03 or 5730A/05) requires two kinds of calibration: gain and flatness. Gain constants are checked and recalibrated as part of the normal 5730A Calibrator semi-automated calibration process.

Since frequency flatness is determined by such stable parameters as circuit geometry and dielectric constants, flatness of the Wideband AC Module has excellent long-term stability. This stability gives the Wideband AC Module a two-year calibration cycle for flatness calibration. Flatness calibration is required only infrequently, and can be done when the Calibrator is returned to a standards laboratory for periodic verification. Chapter 7 of this manual contains the wideband gain and flatness calibration procedures.

The Components of the Calibrator

The 5730A Calibrator is configured internally as an automated calibration system, with process controls and consistent procedures. Internal microprocessors control all functions and monitor performance with the use of a switching matrix to route signals between modules. Complete automatic internal diagnostics, both analog and digital, confirm operational integrity.

Reference amplifiers maintain dc accuracy and stability. Reference amplifiers have the lowest noise and best stability. Reference amplifiers in the Calibrator go through special selection processes that include long-term aging to ensure high reliability and performance well within specifications.

The Calibrator achieves its exceptional ac voltage accuracy by the use of a patented Fluke Calibration rms sensor to make real-time ac/dc comparison measurements. The Fluke Calibration rms sensor is similar in principle to the traditional thermal voltage converter, but has a shorter time constant, virtually no reversal error, higher signal-to-noise ratio, and better frequency response. In the Calibrator, one Fluke Calibration rms sensor serves as an ac/dc or ac/ac transfer standard to develop gain and flatness correction constants during calibration. The second Fluke Calibration rms sensor continuously monitors and corrects output voltage during operation.

A patented 26-bit digital-to-analog converter (DAC) lets the Calibrator precisely vary its output. This is a pulse-width-modulated DAC with linearity typically better than 0.2 ppm of full scale. As with the other internal functions, the linearity of the DAC is automatically checked during calibration and analog diagnostics.

Specifications

The 5730A Calibrator is verified and calibrated at the factory prior to shipment to ensure it meets the accuracy standards necessary for all certified calibration laboratories. By calibrating to the specifications in this chapter, the high-performance level can be maintained throughout the life of the Calibrator.

Specifications are valid after a warm-up period of twice the time the Calibrator has been turned off, up to a maximum of 30 minutes. For example, if the Calibrator has been turned off for five minutes, the warm-up period is 10 minutes.

Specification Confidence Levels

5730A Calibrator performance level is ensured by regular calibration to the primary performance specifications. These specifications are provided at both the 99 % and 95 % confidence levels. Calibration at the 99 % confidence level is guaranteed by calibration at Fluke Calibration and Fluke Calibration Service Centers. For information on selecting the confidence level, refer to Chapter 4.

The tables in this chapter provide specifications at both the 95 % and 99 % confidence levels for the Calibrators. Included with these tables are operating specifications for use of the Calibrator with the Wideband AC Module (Option 5730A/03) and the 5725A and 52120A Amplifiers.

Use of Absolute and Relative Accuracy Specifications

To evaluate the 5730A Calibrator coverage of the calibration workload, use the Absolute Accuracy specifications. Absolute accuracy includes stability, temperature coefficient, linearity, line and load regulation, and the traceability to external standards. It is not necessary to add anything to absolute accuracy to determine the ratios between the Calibrator specifications and the tolerance requirements of the calibration workload.

Relative accuracy specifications are provided for enhanced accuracy applications. These specifications apply when range constants are adjusted (see “Range Adjustment” in Chapter 7). To calculate absolute accuracy, combine the uncertainties of the external standards and techniques with relative accuracy.

The accuracy specifications can be used to determine the component of instrumental uncertainty for a particular measurement condition at time of use. When the Calibrator is correctly calibrated, the specifications may be applied to subsequent uncertainty analyses as a Type B evaluation of measurement uncertainty. This is estimated as a normal distribution with a coverage factor of $K=2.58$. Instrumental measurement uncertainty is one of many contributors that must be considered in a thorough uncertainty analysis.

Use of Secondary Performance Specifications

Secondary performance specifications and operating characteristics are included in uncertainty specifications. They are provided for special calibration requirements such as stability or linearity tests.

General Specifications

Warm-Up Time	Twice the time since last warmed up, to a maximum of 30 minutes.
System Installation	Rack mount kits available.
Standard Interfaces	IEEE-488, RS-232, USB 2.0 device, Ethernet, 5725A, 52120A, phase lock in (BNC), phase reference out (BNC).
Temperature Performance	
Operating	0 °C to 50 °C
Calibration.....	15 °C to 35 °C
Storage	-40 °C to 75 °C
Relative Humidity	
Operating	<80 % to 30 °C, <70 % to 40 °C, <40 % to 50 °C
Storage	<95 %, non-condensing. A power stabilization period of four days may be required after extended storage at high temperature and humidity.
Safety	IEC 61010-1: Overvoltage Category II, Pollution Degree 2
Operating Altitude	2000 m maximum
Guard Isolation	20 V
Electromagnetic Compatibility (EMC)	
IEC 61326-1 (Controlled EM environment).....	IEC 61326-2-1; CISPR 11: Group 1, Class A Group 1 equipment has intentionally generated and/or use conductively coupled radio-frequency energy which is necessary for the internal functioning of the equipment itself. Class A equipment is equipment suitable for use in all establishments other than domestic and those directly connected to a low voltage power supply network which supplies buildings used for domestic purposes. Emissions which exceed the levels required by CISPR 11 can occur when the equipment is connected to a test object. The equipment may not meet the immunity requirements of 61326-1 when test leads and/or test probes are connected.
USA (FCC).....	47 CFR 15 subpart B, this product is considered an exempt device per clause 15.103
Korea (KCC)	Class A Equipment (Industrial Broadcasting & Communication Equipment) This product meets requirements for industrial (Class A) electromagnetic wave equipment and the seller or user should take notice of it. This equipment is intended for use in business environments and not to be used in homes.
Line Power	
Line Voltage	
5730A	100 V-120 V, 220 V- 240 V ±10 %
5725A	100 V, 110 V, 115 V, 120 V, 200 V, 220 V, 230 V, 240 V, ±10 %
Line Frequency	47 Hz-63 Hz
Maximum Power	
5730A	300 VA
5725A	750 VA
Weight	
5730A	27 kg (62 lb)
5725A	32 kg (70 lb)

Size

5730A

- Height 17.8 cm (7 in), standard rack increment, plus 1.5 cm (0.6 in) for feet
- Width 43.2 cm (17 in), standard rack width
- Depth 64.8 cm (25.5 in), overall; 59.4 cm (23.4 in), rack depth

5725A

- Height 13.3 cm (5.25 in)
- Width and Depth Both units project 5.1 cm (2 in) from rack front.

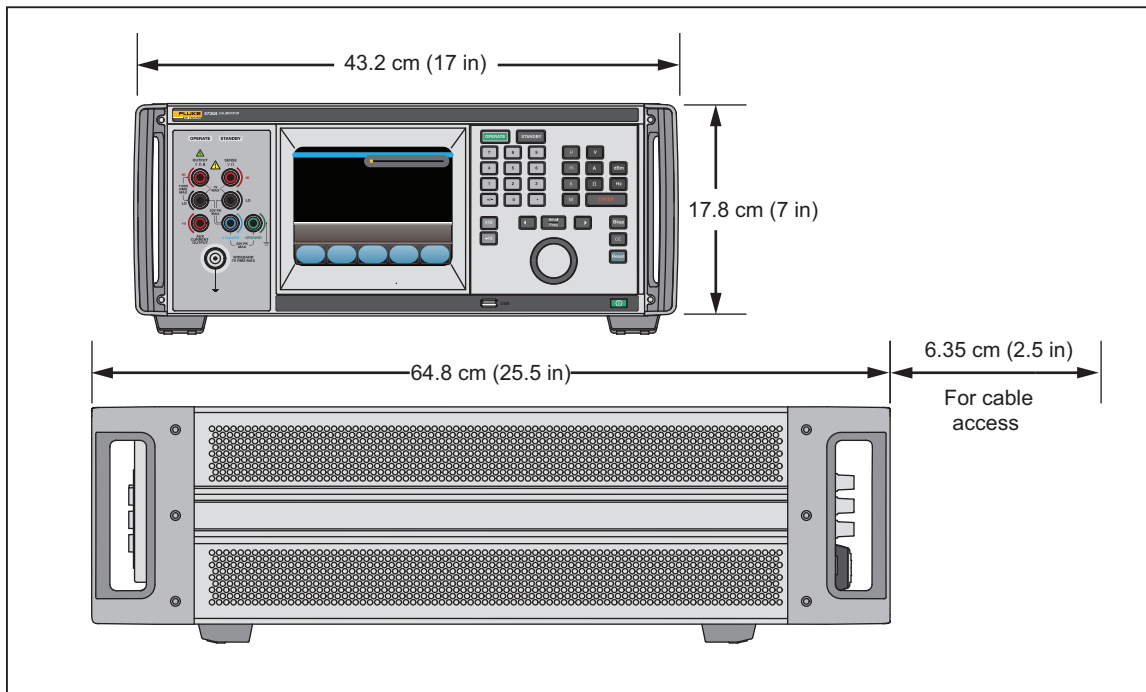

hhp002.eps

Figure 5. Product Dimensions

Artifact Calibration Standards Requirements

The following external standards are necessary to calibrate the 5730A to the listed specification. Each external standard used must have an uncertainty equal to or less than the listed uncertainty limit.

Fluke Standard	Traceable Quantity	Nominal Value	Uncertainty Limit	5730A Specifications Susceptible to Uncertainty Limit
732B	Voltage	10 V	1.5 ppm	dc volts, ac volts, dc current, ac current
742A-1	Resistance	1 Ω	10 ppm	1 Ω , 1.9 Ω
742A-10k	Resistance	10 k Ω	2 ppm	ac current, dc current 10 Ω to 100 M Ω

Electrical Specifications

The product specifications describe the Absolute Instrumental Uncertainty of the Product. The product specifications include stability, temperature, and humidity; within specified limits, linearity, line and load regulation, and the reference standard measurement uncertainty. The product specifications are provided at a 99 %, k=2.58, normally distributed and a 95 %, k=2, normally distributed level of confidence. Fluke Calibration guarantees product performance to the 99 % level of confidence.

The relative specifications are provided for enhanced accuracy applications. The specifications apply when range constants are adjusted (see "Range Calibration"). To Calculate an enhanced absolute specification from the relative accuracy specification, it is necessary to combine the uncertainty of your external standards with the pertinent relative specifications.

Specifications are valid after allowing a warm-up period of 30 minutes, or twice the time the Product has been turned off.
DC Voltage Specifications

5730A DC Voltage Specifications

Range	Resolution	Absolute / ± 5 °C from calibration temperature				Relative ± 1 °C	
		24 Hours	90 Days	180 Days	1 Year	24 Hours	90 Days
		$\pm(\text{ppm output}^{[1]} + \mu\text{V})$					
99 % Confidence Level							
220 mV	10 nV	5 + 0.5	7 + 0.5	8 + 0.5	9 + 0.5	2 + 0.4	2.5 + 0.4
2.2 V	100 nV	3.5 + 0.8	4 + 0.8	4.5 + 0.8	6 + 0.8	2 + 0.8	2.5 + 0.8
11 V	1 μV	2.5 + 3	3 + 3	3.5 + 3	4 + 3	1 + 3	1.5 + 3
22 V	1 μV	2.5 + 5	3 + 5	3.5 + 5	4 + 5	1 + 5	1.5 + 5
220 V	10 μV	3.5 + 50	4 + 50	5 + 50	6 + 50	2 + 50	2.5 + 50
1100 V	100 μV	5 + 500	6 + 500	7 + 500	8 + 500	2.5 + 400	3 + 400
95 % Confidence Level							
220 mV	10 nV	4 + 0.4	6 + 0.4	6.5 + 0.4	7.5 + 0.4	1.6 + 0.4	2 + 0.4
2.2 V	100 nV	3 + 0.7	3.5 + 0.7	4 + 0.7	5 + 0.7	1.6 + 0.7	2 + 0.7
11 V	1 μV	2 + 2.5	2.5 + 2.5	3 + 2.5	3.5 + 2.5	0.8 + 2.5	1.2 + 2.5
22 V	1 μV	2 + 4	2.5 + 4	3 + 4	3.5 + 4	0.8 + 4	1.2 + 4
220 V	10 μV	3 + 40	3.5 + 40	4 + 40	5 + 40	1.6 + 40	2 + 40
1100 V	100 μV	4 + 400	4.5 + 400	6 + 400	6.5 + 400	2 + 400	2.4 + 400
Notes:							
Perform the DC Zero calibration every 30 days. In addition, perform the DC Zero calibration after powering up the unit the first time after unpacking following a shipment or if exposed to an environmental change of greater than 5 °C.							
1. For radiated EMI fields >400 MHz and <500 MHz, add 1 ppm.							

DC Voltage Secondary Performance Specifications and Operating Characteristics

Range	Stability ^[1] ± 1 °C 24 Hours	Temperature Coefficient Adder ^[2]		Linearity ± 1 °C	Noise	
		10 - 40 °C	0 - 10 °C and 40 - 50 °C		Bandwidth 0.1 - 10 Hz pk-pk	Bandwidth 10 - 10 kHz RMS
		$\pm(\text{ppm output} + \mu\text{V}) / \text{°C}$			$\pm(\text{ppm output} + \mu\text{V})$	
220 mV	0.3 + 0.3	0.4 + 0.1	1.5 + 0.5	1 + 0.2	0.15 + 0.1	5
2.2 V	0.3 + 1	0.3 + 0.1	1.5 + 2	1 + 0.6	0.15 + 0.4	15
11 V	0.3 + 2.5	0.15 + 0.2	1 + 1.5	0.3 + 2	0.15 + 2	50
22 V	0.4 + 5	0.2 + 0.4	1.5 + 3	0.3 + 4	0.15 + 4	50
220 V	0.5 + 40	0.3 + 5	1.5 + 40	1 + 40	0.15 + 60	150
1100 V	0.5 + 200	0.5 + 10	3 + 200	1 + 200	0.15 + 300	500
Notes:						
1. Stability specifications are included in the absolute specification values in the primary specification tables.						
2. Temperature coefficient is an adder to accuracy specifications that does <i>not</i> apply unless operating more than ± 5 °C from calibration temperature.						

Minimum Output	0 V for all ranges, except 100 V for 1100 V range
Maximum Load	50 mA for 2.2 V through 220 V ranges; 20 mA for 1100 V range; 50 Ω output impedance on 220 mV range; all ranges <1000 pF, >25 Ω
Load Regulation	<(0.2 ppm of output + 0.1 ppm of range), full load to no load
Line Regulation	<0.1 ppm change, ± 10 % of selected nominal line
Settling Time	3 seconds to full specification; + 1 second for range or polarity change; + 1 second for 1100 V range
Overshoot	<5 %
Common Mode Rejection	140 dB, DC to 400 Hz
Remote Sensing	Available 0 V to ± 1100 V, on 2.2 V through 1100 V ranges

AC Voltage Specifications

5730A AC Voltage Specifications: 99 % Confidence Level

Range	Resolution	Frequency (Hz)	Absolute / ± 5 °C from calibration temperature				Relative ± 1 °C	
			24 Hours	90 Days	180 Days	1 Year	24 Hours	90 Days
$\pm(\text{ppm output} + \mu\text{V})$								
2.2 mV	1 nV	10 - 20	250 + 5	270 + 5	290 + 5	300 + 5	250 + 5	270 + 5
		20 - 40	100 + 5	105 + 5	110 + 5	115 + 5	100 + 5	105 + 5
		40 - 20 k	85 + 5	90 + 5	95 + 5	100 + 5	60 + 5	65 + 5
		20 k - 50 k	220 + 5	230 + 5	240 + 5	250 + 5	85 + 5	95 + 5
		50 k - 100 k	500 + 6	540 + 6	570 + 6	600 + 6	200 + 6	220 + 6
		100 k - 300 k	1000 + 12	1200 + 12	1250 + 12	1300 + 12	350 + 12	400 + 12
		300 k - 500 k	1400 + 25	1500 + 25	1600 + 25	1700 + 25	800 + 25	1000 + 25
500 k - 1 M	2900 + 25	3100 + 25	3250 + 25	3400 + 25	2700 + 25	3000 + 25		
22 mV	10 nV	10 - 20	250 + 5	270 + 5	290 + 5	300 + 5	250 + 5	270 + 5
		20 - 40	100 + 5	105 + 5	110 + 5	115 + 5	100 + 5	105 + 5
		40 - 20 k	85 + 5	90 + 5	95 + 5	100 + 5	60 + 5	65 + 5
		20 k - 50 k	220 + 5	230 + 5	240 + 5	250 + 5	85 + 5	95 + 5
		50 k - 100 k	500 + 6	540 + 6	570 + 6	600 + 6	200 + 6	220 + 6
		100 k - 300 k	1000 + 12	1200 + 12	1250 + 12	1300 + 12	350 + 12	400 + 12
		300 k - 500 k	1400 + 25	1500 + 25	1600 + 25	1700 + 25	800 + 25	1000 + 25
500 k - 1 M	2900 + 25	3100 + 25	3250 + 25	3400 + 25	2700 + 25	3000 + 25		
220 mV	100 nV	10 - 20	250 + 15	270 + 15	290 + 15	300 + 15	250 + 15	270 + 15
		20 - 40	100 + 8	105 + 8	110 + 8	115 + 8	100 + 8	105 + 8
		40 - 20 k	65 + 8	66 + 8	67 + 8	70 + 8	60 + 8	65 + 8
		20 k - 50 k	135 + 8	140 + 8	145 + 8	150 + 8	85 + 8	95 + 8
		50 k - 100 k	370 + 20	380 + 20	390 + 20	400 + 20	200 + 20	220 + 20
		100 k - 300 k	650 + 25	700 + 25	750 + 25	800 + 25	350 + 25	400 + 25
		300 k - 500 k	1400 + 30	1500 + 30	1600 + 30	1700 + 30	800 + 30	1000 + 30
500 k - 1 M	2700 + 60	2900 + 60	3100 + 60	3300 + 60	2600 + 60	2800 + 60		
2.2 V	1 μ V	10 - 20	250 + 50	270 + 50	290 + 50	300 + 50	250 + 50	270 + 50
		20 - 40	95 + 20	100 + 20	105 + 20	110 + 20	95 + 20	100 + 20
		40 - 20 k	45 + 10	46 + 10	47 + 10	48 + 10	30 + 10	40 + 10
		20 k - 50 k	75 + 12	77 + 12	78 + 12	80 + 12	70 + 12	75 + 12
		50 k - 100 k	95 + 40	97 + 40	98 + 40	100 + 40	100 + 40	105 + 40
		100 k - 300 k	350 + 100	370 + 100	380 + 100	400 + 100	270 + 100	290 + 100
		300 k - 500 k	1000 + 250	1100 + 250	1150 + 250	1200 + 250	900 + 250	1000 + 250
500 k - 1 M	1600 + 400	1800 + 400	1900 + 400	2000 + 400	1200 + 400	1300 + 400		

Range	Resolution	Frequency (Hz)	Absolute / ±5 °C from calibration temperature				Relative ±1 °C	
			24 Hours	90 Days	180 Days	1 Year	24 Hours	90 Days
			±(ppm output + μV)					
22 V	10 μV	10 - 20	250 + 500	270 + 500	290 + 500	300 + 500	250 + 500	270 + 500
		20 - 40	95 + 200	100 + 200	105 + 200	110 + 200	95 + 200	100 + 200
		40 - 20 k	45 + 70	46 + 70	47 + 70	48 + 70	30 + 70	40 + 70
		20 k - 50 k	75 + 120	77 + 120	78 + 120	80 + 120	70 + 120	75 + 120
		50 k - 100 k	95 + 250	97 + 250	98 + 250	100 + 250	100 + 250	105 + 250
		100 k - 300 k	285 + 800	290 + 800	295 + 800	300 + 800	270 + 800	290 + 800
		300 k - 500 k	1000 + 2500	1100 + 2500	1150 + 2500	1200 + 2500	900 + 2500	1000 + 2500
500 k - 1 M	1500 + 4000	1600 + 4000	1700 + 4000	1800 + 4000	1300 + 4000	1400 + 4000		
			±(ppm output + mV)					
220 V ^[2]	100 μV	10 - 20	250 + 5	270 + 5	290 + 5	300 + 5	250 + 5	270 + 5
		20 - 40	95 + 2	100 + 2	105 + 2	110 + 2	95 + 2	100 + 2
		40 - 20 k	57 + 0.7	60 + 0.7	62 + 0.7	65 + 0.7	45 + 0.7	50 + 0.7
		20 k - 50 k	90 + 1.2	95 + 1.2	97 + 1.2	100 + 1.2	75 + 1.2	80 + 1.2
		50 k - 100 k	160 + 3	170 + 3	175 + 3	180 + 3	140 + 3	150 + 3
		100 k - 300 k	900 + 20	1000 + 20	1050 + 20	1100 + 20	600 + 20	700 + 20
		300 k - 500 k	5000 + 50	5200 + 50	5300 + 50	5400 + 50	4500 + 50	4700 + 50
500 k - 1 M	8000 + 100	9000 + 100	9500 + 100	10,000 + 100	8000 + 100	8500 + 100		
1100 V ^[1]	1 mV	15 - 50	300 + 20	320 + 20	340 + 20	360 + 20	300 + 20	320 + 20
		50 - 1 k	70 + 4	75 + 4	80 + 4	85 + 4	50 + 4	55 + 4
5725A Amplifier:								
1100 V	1 mV	40 - 1 k	75 + 4	80 + 4	85 + 4	90 + 4	50 + 4	55 + 4
		1 k - 20 k	105 + 6	125 + 6	135 + 6	165 + 6	85 + 6	105 + 6
		20 k - 30 k	230 + 11	360 + 11	440 + 11	600 + 11	160 + 11	320 + 11
750 V	1 mV	30 k - 50 k	230 + 11	360 + 11	440 + 11	600 + 11	160 + 11	320 + 11
		50 k - 100 k	600 + 45	1300 + 45	1600 + 45	2300 + 45	380 + 45	1200 + 45
Notes:								
1. Maximum output 250 V from 15-50 Hz.								
2. See Volt-Hertz capability in Figure A.								

5730A AC Voltage Specifications: 95 % Confidence Level

Range	Resolution	Frequency (Hz)	Absolute / ±5 °C from calibration temperature				Relative ±1 °C	
			24 Hours	90 Days	180 Days	1 Year	24 Hours	90 Days
			±(ppm output + μV)					
2.2 mV	1 nV	10 - 20	200 + 4	220 + 4	230 + 4	240 + 4	200 + 4	220 + 4
		20 - 40	80 + 4	85 + 4	87 + 4	90 + 4	80 + 4	85 + 4
		40 - 20 k	70 + 4	75 + 4	77 + 4	80 + 4	50 + 4	55 + 4
		20 k - 50 k	170 + 4	180 + 4	190 + 4	200 + 4	70 + 4	80 + 4
		50 k - 100 k	400 + 5	460 + 5	480 + 5	500 + 5	160 + 5	180 + 5
		100 k - 300 k	800 + 10	900 + 10	1000 + 10	1050 + 10	280 + 10	320 + 10
		300 k - 500 k	1100 + 20	1200 + 20	1300 + 20	1400 + 20	650 + 20	800 + 20
500 k - 1 M	2400 + 20	2500 + 20	2600 + 20	2700 + 20	2100 + 20	2400 + 20		
22 mV	10 nV	10 - 20	200 + 4	220 + 4	230 + 4	240 + 4	200 + 4	220 + 4
		20 - 40	80 + 4	85 + 4	87 + 4	90 + 4	80 + 4	85 + 4
		40 - 20 k	70 + 4	75 + 4	77 + 4	80 + 4	50 + 4	55 + 4
		20 k - 50 k	170 + 4	180 + 4	190 + 4	200 + 4	70 + 4	80 + 4
		50 k - 100 k	400 + 5	460 + 5	480 + 5	500 + 5	160 + 5	180 + 5
		100 k - 300 k	800 + 10	900 + 10	1000 + 10	1050 + 10	280 + 10	320 + 10
		300 k - 500 k	1100 + 20	1200 + 20	1300 + 20	1400 + 20	650 + 20	800 + 20
500 k - 1 M	2400 + 20	2500 + 20	2600 + 20	2700 + 20	2100 + 20	2400 + 20		
220 mV	100 nV	10 - 20	200 + 12	220 + 12	230 + 12	240 + 12	200 + 12	220 + 12
		20 - 40	80 + 7	85 + 7	87 + 7	90 + 7	80 + 7	85 + 7
		40 - 20 k	54 + 7	55 + 7	56 + 7	57 + 7	50 + 7	55 + 7
		20 k - 50 k	105 + 7	110 + 7	115 + 7	120 + 7	70 + 7	80 + 7
		50 k - 100 k	296 + 17	298 + 17	303 + 17	310 + 17	160 + 17	180 + 17
		100 k - 300 k	535 + 20	583 + 20	600 + 20	655 + 20	280 + 20	320 + 20
		300 k - 500 k	1100 + 25	1200 + 25	1300 + 25	1400 + 25	650 + 25	800 + 25
500 k - 1 M	2400 + 45	2500 + 45	2600 + 45	2700 + 45	2100 + 45	2400 + 45		

Range	Resolution	Frequency (Hz)	Absolute / ± 5 °C from calibration temperature				Accuracy ± 1 °C	
			24 Hours	90 Days	180 Days	1 Year	24 Hours	90 Days
			$\pm(\text{ppm output} + \mu\text{V})$					
			$\pm(\text{ppm output} + \text{mV})$					
2.2 V	1 μV	10 - 20	200 + 40	220 + 40	230 + 40	240 + 40	200 + 40	220 + 40
		20 - 40	75 + 15	80 + 15	85 + 15	90 + 15	75 + 15	80 + 15
		40 - 20 k	37 + 8	39 + 8	40 + 8	42 + 8	25 + 8	35 + 8
		20 k - 50 k	61 + 10	63 + 10	65 + 10	67 + 10	55 + 10	60 + 10
		50 k - 100 k	79 + 30	81 + 30	82 + 30	85 + 30	80 + 30	85 + 30
		100 k - 300 k	276 + 80	300 + 80	314 + 80	336 + 80	230 + 80	250 + 80
		300 k - 500 k	800 + 200	900 + 200	950 + 200	1000 + 200	700 + 200	800 + 200
500 k - 1 M	1300 + 300	1500 + 300	1600 + 300	1700 + 300	1000 + 300	1100 + 300		
22 V	10 μV	10 - 20	200 + 400	220 + 400	230 + 400	240 + 400	200 + 400	220 + 400
		20 - 40	75 + 150	80 + 150	85 + 150	90 + 150	75 + 150	80 + 150
		40 - 20k	37 + 50	39 + 50	40 + 50	42 + 50	25 + 50	35 + 50
		20k - 50k	61 + 100	63 + 100	65 + 100	67 + 100	55 + 100	60 + 100
		50k - 100k	78 + 200	80 + 200	81 + 200	83 + 200	80 + 200	85 + 200
		100k - 300k	238 + 600	243 + 600	249 + 600	254 + 600	250 + 600	270 + 600
		300k - 500k	800 + 2000	900 + 2000	900 + 2000	1000 + 2000	700 + 2000	800 + 2000
500k - 1M	1200 + 3200	1300 + 3200	1400 + 3200	1500 + 3200	1100 + 3200	1200 + 3200		
220 V ^[2]	100 μV	10 - 20	200 + 4	220 + 4	230 + 4	240 + 4	200 + 4	220 + 4
		20 - 40	75 + 1.5	80 + 1.5	85 + 1.5	90 + 1.5	75 + 1.5	80 + 1.5
		40 - 20 k	45 + 0.6	47 + 0.6	50 + 0.6	52 + 0.6	35 + 0.6	40 + 0.6
		20 k - 50 k	70 + 1	75 + 1	77 + 1	80 + 1	60 + 1	65 + 1
		50 k - 100 k	120 + 2.5	130 + 2.5	140 + 2.5	150 + 2.5	110 + 2.5	120 + 2.5
		100 k - 300 k	700 + 16	800 + 16	850 + 16	900 + 16	500 + 16	600 + 16
		300 k - 500 k	4000 + 40	4200 + 40	4300 + 40	4400 + 40	3600 + 40	3800 + 40
500 k - 1 M	6000 + 80	7000 + 80	7500 + 80	8000 + 80	6500 + 80	7000 + 80		
1100 V ^[1]	1 mV	15 - 50	240 + 16	260 + 16	280 + 16	300 + 16	240 + 16	260 + 16
		50 - 1 k	55 + 3.5	60 + 3.5	65 + 3.5	70 + 3.5	40 + 3.5	45 + 3.5
5725A Amplifier:								
1100 V	1 mV	40 - 1 k	75 + 4	80 + 4	85 + 4	90 + 4	50 + 4	55 + 4
		1 k - 20 k	105 + 6	125 + 6	135 + 6	165 + 6	85 + 6	105 + 6
		20 k - 30 k	230 + 11	360 + 11	440 + 11	600 + 11	160 + 11	320 + 11
750 V	1 mV	30 k - 50 k	230 + 11	360 + 11	440 + 11	600 + 11	160 + 11	320 + 11
		50 k - 100 k	600 + 45	1300 + 45	1600 + 45	2300 + 45	380 + 45	1200 + 45
Notes:								
1. Maximum output 250 V from 15-50 Hz.								
2. See Volt-Hertz capability in Figure A.								

AC Voltage Secondary Performance Specifications and Operating Characteristics

Range	Frequency (Hz)	Stability $\pm 1^\circ\text{C}$ ^[1] 24 Hours	Temperature Coefficient		Output Impedance (Ω)	Maximum Distortion Bandwidth 10 Hz- 10 MHz
			10 - 40 $^\circ\text{C}$	0 - 10 $^\circ\text{C}$ and 40 - 50 $^\circ\text{C}$		
		$\pm\mu\text{V}$	$\pm\mu\text{V} / ^\circ\text{C}$		$\pm(\% \text{ output} + \mu\text{V})$	
2.2 mV	10 - 20	5	0.05	0.05	50	0.05 + 10
	20 - 40	5	0.05	0.05		0.035 + 10
	40 - 20 k	2	0.05	0.05		0.035 + 10
	20 k - 50 k	2	0.1	0.1		0.035 + 10
	50 k - 100 k	3	0.2	0.2		0.035 + 30
	100 k - 300 k	3	0.3	0.3		0.3 + 30
	300 k - 500 k	5	0.4	0.4		0.3 + 30
500 k - 1 M	5	0.5	0.5	2 + 50		
22 mV	10 - 20	5	0.2	0.3	50	0.05 + 11
	20 - 40	5	0.2	0.3		0.035 + 11
	40 - 20 k	2	0.2	0.3		0.035 + 11
	20 k - 50 k	2	0.4	0.5		0.035 + 11
	50 k - 100 k	3	0.5	0.5		0.035 + 30
	100 k - 300 k	5	0.6	0.6		0.3 + 30
	300 k - 500 k	10	1	1		0.3 + 30
500 k - 1 M	15	1	1	2 + 30		
		$\pm(\text{ppm output} + \mu\text{V})$	$\pm(\text{ppm output } \mu\text{V}) / ^\circ\text{C}$			
220 mV	10 - 20	150 + 20	2 + 1	2 + 1	50	0.05 + 16
	20 - 40	80 + 15	2 + 1	2 + 1		0.035 + 16
	40 - 20 k	12 + 2	2 + 1	2 + 1		0.035 + 16
	20 k - 50 k	10 + 2	15 + 2	15 + 2		0.035 + 16
	50 k - 100 k	10 + 2	15 + 4	15 + 4		0.035 + 30
	100 k - 300 k	20 + 4	80 + 5	80 + 5		0.3 + 30
	300 k - 500 k	100 + 10	80 + 5	80 + 5		0.3 + 30
500 k - 1 M	200 + 20	80 + 5	80 + 5	1 + 30		
					Load Regulation $\pm(\text{ppm output} + \mu\text{V})$	
2.2 V	10 - 20	150 + 20	50 + 10	50 + 10	10 + 2	0.05 + 80
	20 - 40	80 + 15	15 + 5	15 + 5	10 + 2	0.035 + 80
	40 - 20 k	12 + 4	2 + 1	5 + 2	10 + 4	0.035 + 80
	20 k - 50 k	15 + 5	10 + 2	15 + 4	30 + 10	0.035 + 80
	50 k - 100 k	15 + 5	10 + 4	20 + 4	120 + 16	0.035 + 110
	100 k - 300 k	30 + 10	80 + 15	80 + 15	300 ppm	0.3 + 110
	300 k - 500 k	70 + 20	80 + 40	80 + 40	600 ppm	0.5 + 110
500 k - 1 M	150 + 50	80 + 100	80 + 100	1200 ppm	1 + 110	
22 V	10 - 20	150 + 20	50 + 100	50 + 100	10 + 20	0.05 + 700
	20 - 40	80 + 15	15 + 30	15 + 40	10 + 20	0.035 + 700
	40 - 20 k	12 + 8	2 + 10	4 + 15	10 + 30	0.035 + 700
	20 k - 50 k	15 + 10	10 + 20	20 + 20	30 + 50	0.035 + 700
	50 k - 100 k	15 + 10	10 + 40	20 + 40	80 + 80	0.05 + 800
	100 k - 300 k	30 + 15	80 + 150	80 + 150	100 + 700	0.3 + 800
	300 k - 500 k	70 + 100	80 + 300	80 + 300	200 + 1100	0.3 + 800
500 k - 1 M	150 + 100	80 + 500	80 + 500	600 + 3000	2 + 800	
220 V	10 - 20	150 + 200	50 + 1000	50 + 1000	10 + 200	0.05 + 10,000
	20 - 40	80 + 150	15 + 300	15 + 300	10 + 200	0.05 + 10,000
	40 - 20 k	12 + 80	2 + 80	4 + 80	10 + 300	0.05 + 10,000
	20 k - 50 k	15 + 100	10 + 100	20 + 100	30 + 600	0.05 + 10,000
	50 k - 100 k	15 + 100	10 + 500	20 + 500	80 + 3,000	0.2 + 50,000
	100 k - 300 k	30 + 400	80 + 600	80 + 600	250 + 25,000	1.5 + 50,000
	300 k - 500 k	100 + 10,000	80 + 800	80 + 800	500 + 50,000	1.5 + 50,000
500 k - 1 M	200 + 20,000	80 + 1000	80 + 1000	1000 + 110,000	3.5 + 100,000	
		$\pm(\text{ppm output} + \text{mV})$	$\pm(\text{ppm output}) / ^\circ\text{C}$		$\pm(\text{ppm output} + \text{mV})$	$\pm(\% \text{ output})$
1100 V	15 - 50	150 + 0.5	50	50	10 + 2	0.15
	50 - 1 k	20 + 0.5	2	5	10 + 1	0.07

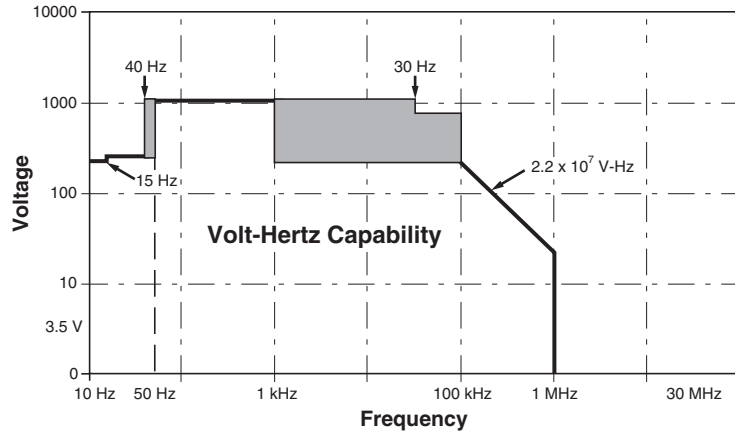

Figure A.

5725A Amplifier:							
Range	Frequency (Hz)	Stability ±1 °C ^[1] 24 Hours	Temperature Coefficient Adder		Load Regulation ^[2]	Distortion Bandwidth 10 Hz -10 MHz ±(% output)	
			10 - 40 °C	0 - 10 °C and 40 - 50 °C		150 pF	1000 pF
		±(ppm output + mV)	±(ppm output) / °C		±(ppm output + mV)		
1100 V	40 - 1 k	10 + .5	5	5	10 + 1	0.10	0.10
	1 k - 20 k	15 + 2	5	5	90 + 6	0.10	0.15
	20 k - 50 k	40 + 2	10	10	275 + 11	0.30	0.30
	50 k - 100 k	130 + 2	30	30	500 + 30	0.40	0.40
Notes:							
1. Stability specifications are included in Absolute specification values for the primary specifications.							
2. The 5725A will drive up to 1000 pF of load capacitance. Absolute specifications include loads to 300 pF and 150 pF as shown under "Load Limits." For capacitances up to the maximum of 1000 pF, add "Load Regulation."							

Voltage Range	Maximum Current Limits	Load Limits
2.2 V ^[2]		
22 V	50 mA, 0 °C-40 °C	>50 Ω,
220 V	20 mA, 40 °C-50 °C	1000 pF
1100 V	6 mA	600 pF
5725A Amplifier:		
1100 V	40 Hz-5 kHz	50 mA
	5 kHz-30 kHz	70 mA
	30 kHz-100 kHz	70 mA ^[3]
		1000 pF ^[1]
		300 pF
		150 pF
Notes:		
1. The 5725A will drive up to 1000 pF of load capacitance. Absolute specifications include loads to 300 pF and 150 pF as shown under "Load Limits." For capacitances up to the maximum of 1000 pF, add "Load Regulation."		
2. 2.2 V Range, 100 kHz-1.2 MHz only: Absolute specifications cover loads to 10 mA or 1000 pF. For higher loads, load regulation is added.		
3. Applies from 0 °C to 40 °C.		

Output Display Formats Voltage or dBm, dBm reference 600 Ω.

Minimum Output 10 % on each range

External Sense Applicable for 2.2 V, 22 V, 220 V, and 1100 V ranges; 5730A <100 kHz, 5725A <30 kHz. Specifications are the same as internal sense.

Resistance Specifications**5730A Resistance Specifications**

Nominal Value (Ω)	Absolute Specification of Characterized Value $\pm 5^\circ\text{C}$ from calibration temperature ^[1]				Relative $\pm 1^\circ\text{C}$	
	24 Hours	90 Days	180 Days	1 Year	24 Hours	90 Days
	$\pm\text{ppm}$					
99 % Confidence Level						
0	50 $\mu\Omega$	50 $\mu\Omega$	50 $\mu\Omega$	50 $\mu\Omega$	50 $\mu\Omega$	50 $\mu\Omega$
1	85	95	100	110	32	40
1.9	85	95	100	110	25	33
10	23	25	26	27	5	8
19	23	25	26	27	4	7
100	10	11	11.5	12	2	4
190	10	11	11.5	12	2	4
1 k	7	7.2	7.5	8	2	3
1.9 k	7	7.2	7.5	8	2	3
10 k	6	7	7.5	8	2	3
19 k	6	7	7.5	8	2	3
100 k	7	8	9	10	2	3
190 k	8	10	11	12	2	3
1 M	13	14	14.5	15	2.5	5
1.9 M	15	17	19	21	3	6
10 M	33	37	40	46	10	14
19 M	43	47	50	55	20	24
100 M	100	110	115	120	50	60
95 % Confidence Level						
0	40 $\mu\Omega$	40 $\mu\Omega$	40 $\mu\Omega$	40 $\mu\Omega$	40 $\mu\Omega$	40 $\mu\Omega$
1	70	80	85	95	27	35
1.9	70	80	85	95	20	26
10	20	21	22	23	4	7
19	20	21	22	23	3.5	6
100	8	9	9.5	10	1.6	3.5
190	8	9	9.5	10	1.6	3.5
1 k	5.5	5.7	6	6.5	1.6	2.5
1.9 k	5.5	5.7	6	6.5	1.6	2.5
10 k	5	5.5	6	6.5	1.6	2.5
19 k	5	5.5	6	6.5	1.6	2.5
100 k	5.5	7.5	8	8.5	1.6	2.5
190 k	6	7	8	8.5	1.6	2.5
1 M	10	11	12	13	2	4
1.9 M	12	13.5	15	18	2.5	4
10 M	27	31	34	40	8	12
19 M	35	39	42	47	16	20
100 M	85	95	100	100	40	50

Note:
1. Specifications apply to displayed value. 4-wire connections, except 100 M Ω .

Resistance Secondary Performance Specifications and Operating Characteristics

Nominal Value (Ω)	Stability ±1 °C ^[1] 24 Hours	Temperature Coefficient Adder ^[2]		Full Spec Load Range ^[3] I _L - I _U (mA)	Maximum Peak Current I _{MAX} (mA)	Maximum Difference of Characterized to Nominal Value	Two-Wire Adder Active Compensation ^[4]	
		10 - 40 °C	0 - 10 °C and 40 - 50 °C				Lead Resistance	
	±ppm	±ppm/°C	±ppm	0.1 Ω	1 Ω			
0	—	—	—	8 - 500	500	—	$2 + \frac{4\mu V}{I_m}$	$4 + \frac{4\mu V}{I_m}$
1	32	4	5	8 - 100	700	500	$2 + \frac{4\mu V}{I_m}$	$4 + \frac{4\mu V}{I_m}$
1.9	25	6	7	8 - 100	500	500	$2 + \frac{4\mu V}{I_m}$	$4 + \frac{4\mu V}{I_m}$
10	5	2	3	8 - 11	220	300	$2 + \frac{4\mu V}{I_m}$	$4 + \frac{4\mu V}{I_m}$
19	4	2	3	8 - 11	160	300	$2 + \frac{4\mu V}{I_m}$	$4 + \frac{4\mu V}{I_m}$
100	2	2	3	8 - 11	70	150	$2 + \frac{4\mu V}{I_m}$	$4 + \frac{4\mu V}{I_m}$
190	2	2	3	8 - 11	50	150	$2 + \frac{4\mu V}{I_m}$	$4 + \frac{4\mu V}{I_m}$
1 k	2	2	3	1 - 2	22	150	10	15
1.9 k	2	2	3	1 - 1.5	16	150	10	15
10 k	2	2	3	100 - 500 μA	7	150	50	60
19 k	2	2	3	50 - 250 μA	5	150	100	120
100 k	2	2	3	10 - 100 μA	1	150	I _m = Current produced by Ohmmeter (A)	
190 k	2	2	3	5 - 100 μA	500 μA	150		
1 M	2.5	2.5	6	5 - 20 μA	100 μA	200		
1.9 M	3.5	3	10	2.5 - 10 μA	50 μA	200		
10 M	10	5	20	0.5 - 2 μA	10 μA	300		
19 M	20	8	40	0.25 - 1 μA	5 μA	300		
100 M	50	12	100	50 - 200 nA	1 μA	500		

Notes:

- Stability specifications are included in the Absolute specification values in the primary specification tables.
- Temperature coefficient is an adder to Absolute specifications that does not apply unless operated more than 5 °C from calibration temperature, or calibrated outside the range 19 °C to 24 °C. Two examples:
 - Calibrate at 20 °C: Temperature coefficient adder is not required unless operated below 15 °C or above 25 °C.
 - Calibrate at 26 °C: Add 2 °C temperature coefficient adder. Additional temperature coefficient adder is not required unless operated below 21 °C or above 31 °C.
- Refer to current derating factors table for loads outside of this range.
- Active two-wire compensation may be selected for values less than 100 kΩ, with either the front panel or the meter input terminals as reference plane. Active compensation is limited to 11 mA load, and to 2 V burden. Two-wire compensation can be used only with Ω-meters that source continuous (not pulsed) dc current.

Current Derating Factors

Nominal Value (Ω)	Value of Derating Factor K for Over or Under Current		
	Two-Wire Comp $I < I_L$ ^[1]	Four-Wire $I < I_L$ ^[1]	Four-Wire $I_U < I < I_{MAX}$ ^[2]
SHORT	4.4	0.3	—
1	4.4	300	4×10^{-5}
1.9	4.4	160	1.5×10^{-4}
10	4.4	30	1.6×10^{-3}
19	4.4	16	3×10^{-3}
100	4.4	3.5	1×10^{-2}
190	4.4	2.5	1.9×10^{-2}
1 k	4.4	0.4	0.1
1.9 k	4.4	0.4	0.19
10 k	5000	50	2.0
19 k	5000	50	3.8
100 k	—	7.5	2×10^{-5}
190 k	—	4.0	3.8×10^{-5}
1 M	—	1.0	1.5×10^{-4}
1.9 M	—	0.53	2.9×10^{-4}
10 M	—	0.2	1×10^{-3}
19 M	—	0.53	1.9×10^{-3}
100 M	—	0.1	—

Notes:

- For $I < I_L$, errors occur due to thermally generated voltages within the 5730A. Use the following equation to determine the error, and add this error to the corresponding specifications.

$$\text{Error} = K(I_L - I)/(I_L \times I)$$
Where: Error is in m Ω for all two-wire comp values and four-wire short, and in ppm for the remaining four-wire values.
K is the constant from the above table;
I and I_L are expressed in mA for short to 1.9 k Ω ;
I and I_L are expressed in μ A for 10 k Ω to 100 M Ω
- For $I_U < I < I_{MAX}$ errors occur due to self-heating of the resistors in the calibrator. Use the following equation to determine the error in ppm and add this error to the corresponding specifications.

$$\text{Error in ppm} = K(I^2 - I_U^2)$$
Where: K is the constant from the above table;
I and I_U are expressed in mA for short to 19 k Ω ;
I and I_U are expressed in μ A for 100 k Ω to 100 M Ω

DC Current Specifications

5730A DC Current Specifications

Range	Resolution	Absolute / ± 5 °C from calibration temperature				Relative ± 1 °C	
		24 Hours	90 Days	180 Days	1 Year	24 Hours	90 Days
	nA	$\pm(\text{ppm output} + \text{nA})$					
99 % Confidence Level							
220 μA	0.1	40 + 7	42 + 7	45 + 7	50 + 7	24 + 2	26 + 2
2.2 mA	1	30 + 8	35 + 8	37 + 8	40 + 8	24 + 5	26 + 5
22 mA	10	30 + 50	35 + 50	37 + 50	40 + 50	24 + 50	26 + 50
	μA	$\pm(\text{ppm output} + \mu\text{A})$					
220 mA ^[1]	0.1	40 + 0.8	45 + 0.8	47 + 0.8	50 + 0.8	26 + 0.3	30 + 0.3
2.2 A ^[1]	1	60 + 15	70 + 15	80 + 15	90 + 15	40 + 7	45 + 7
5725A Amplifier:							
11 A	10	330 + 470	340 + 480	350 + 480	360 + 480	100 + 130	110 + 130
95 % Confidence Level							
	nA	$\pm(\text{ppm output} + \text{nA})$					
220 μA	0.1	32 + 6	35 + 6	37 + 6	40 + 6	20 + 1.6	22 + 1.6
2.2 mA	1	25 + 7	30 + 7	33 + 7	35 + 7	20 + 4	22 + 4
22 mA	10	25 + 40	30 + 40	33 + 40	35 + 40	20 + 40	22 + 40
	μA	$\pm(\text{ppm output} + \mu\text{A})$					
220 mA ^[1]	0.1	35 + 0.7	40 + 0.7	42 + 0.7	45 + 0.7	22 + 0.25	25 + 0.25
2.2 A ^[1]	1	50 + 12	60 + 12	70 + 12	80 + 12	32 + 6	40 + 6
5725A Amplifier:							
11 A	10	330 + 470	340 + 480	350 + 480	360 + 480	100 + 130	110 + 130
<p>Note:</p> <p>Maximum output from the calibrator's terminals is 2.2 A. Specifications for 220 μA and 2.2 mA ranges are increased by a factor of 1.3 when supplied through 5725A terminals.</p> <p>Specifications are otherwise identical for all output locations.</p> <p>1. Add to specifications:</p> <ul style="list-style-type: none"> $\pm 200 \times I^2$ ppm for >100 mA on 220 mA range $\pm 10 \times I^2$ ppm for >1 A on 2.2 A range 							

DC Current Secondary Performance Specifications and Operating Characteristics

Range	Stability ±1 °C ^[1] 24 Hours	Temperature Coefficient ^[2]		Compliance Limits	Burden Voltage Adder ^[3] (±nA/V)	Maximum Load for Published Specification ^[4] (Ω)	Noise	
		10 - 40 °C	0 - 10 °C and 40 - 50 °C				Bandwidth 0.1-10 Hz	Bandwidth 10 Hz-10 kHz
	±(ppm output + nA)	±(ppm output + nA) / °C					pk-pk ppm output + nA	RMS nA
220 µA	5 + 1	1 + 0.40	3 + 1	10	0.2	20k	6 + .9	10
2.2 mA	5 + 5	1 + 2	3 + 10	10	0.2	2k	6 + 5	10
22 mA	5 + 50	1 + 20	3 + 100	10	10	200	6 + 50	50
220 mA	8 + 300	1 + 200	3 + 1 µA	10	100	20	9 + 300	500
2.2 A	9 + 7 µA	1 + 2.5 µA	3 + 10 µA	3 ^[5]	2 µA	2	12 + 1.5 µA	20 µA
5725A	±(ppm output + µA)	±(ppm output + µA)/ °C					ppm output + µA	µA
11 A	25 + 100	20 + 75	30 + 120	4	0	4	15 + 70	175

Notes:

Maximum output from the calibrator's terminals is 2.2 A. Specifications for 220 µA and 2.2 mA ranges are increased by a factor of 1.3 when supplied through 5725A terminals.

- Stability specifications are included in the Absolute specification values for the primary specifications.
- Temperature coefficient is an adder to Absolute specifications. It does not apply unless operating more than ±5 °C from calibration temperature.
- Burden voltage adder is an adder to Absolute specifications that does not apply unless burden voltage is greater than 0.5 V.
- For higher loads, multiply Absolute specification by: $1 + \frac{0.1 \times \text{actual load}}{\text{maximum load for published specification}}$
- The calibrator's compliance limit is 2 V for outputs from 1 A to 2.2 A. 5725A Amplifier may be used in range-lock mode down to 0 A.

Minimum Output 0 for all ranges, including 5725A.

Settling Time 1 second for µA and mA ranges; 3 seconds for 2.2 A range; 6 seconds for 11 range; + 1 second for range or polarity change

Overshoot <5 %

AC Current Specifications

5730A AC Current Specifications: 99 % Confidence Level

Range	Resolution	Frequency (Hz)	Absolute / ±5 °C from calibration temperature				Relative ±1 °C	
			24 Hours	90 Days	180 Days	1 Year	24 Hours	90 Days
			±(ppm output + nA)					
220 µA	1 nA	10 - 20	260 + 20	280 + 20	290 + 20	300 + 20	260 + 20	280 + 20
		20 - 40	170 + 12	180 + 12	190 + 12	200 + 12	130 + 12	150 + 12
		40 - 1 k	115 + 10	117 + 10	118 + 10	120 + 10	100 + 10	110 + 10
		1 k - 5 k	300 + 15	320 + 15	340 + 15	350 + 15	250 + 15	280 + 15
		5 k - 10 k	1000 + 80	1100 + 80	1200 + 80	1300 + 80	900 + 80	1000 + 80
2.2 mA	10 nA	10 - 20	260 + 50	280 + 50	290 + 50	300 + 50	260 + 50	280 + 50
		20 - 40	170 + 40	180 + 40	190 + 40	200 + 40	130 + 40	150 + 40
		40 - 1 k	115 + 40	117 + 40	118 + 40	120 + 40	100 + 40	110 + 40
		1 k - 5 k	210 + 130	220 + 130	230 + 130	240 + 130	190 + 130	220 + 130
		5 k - 10 k	1000 + 800	1100 + 800	1200 + 800	1300 + 800	900 + 800	1000 + 800
22 mA	100 nA	10 - 20	260 + 500	280 + 500	290 + 500	300 + 500	260 + 500	280 + 500
		20 - 40	170 + 400	180 + 400	190 + 400	200 + 400	130 + 400	150 + 400
		40 - 1 k	115 + 400	117 + 400	118 + 400	120 + 400	100 + 400	110 + 400
		1 k - 5 k	210 + 700	220 + 700	230 + 700	240 + 700	190 + 700	220 + 700
		5 k - 10 k	1000 + 6000	1100 + 6000	1200 + 6000	1300 + 6000	900 + 6000	1000 + 6000

Range	Resolution	Frequency (Hz)	Absolute / ± 5 °C from calibration temperature				Relative ± 1 °C	
			24 Hours	90 Days	180 Days	1 Year	24 Hours	90 Days
			$\pm(\text{ppm output} + \text{nA})$					
220 mA	1 μA	10 - 20	260 + 5	280 + 5	290 + 5	300 + 5	260 + 5	280 + 5
		20 - 40	170 + 4	180 + 4	190 + 4	200 + 4	130 + 4	150 + 4
		40 - 1 k	115 + 3	117 + 3	118 + 3	120 + 3	100 + 3	110 + 3
		1 k - 5 k	210 + 4	220 + 4	230 + 4	240 + 4	190 + 4	220 + 4
		5 k - 10 k	1000 + 12	1100 + 12	1200 + 12	1300 + 12	900 + 12	1000 + 12
2.2 A	10 μA	20 - 1 k	270 + 40	280 + 40	290 + 40	300 + 40	260 + 40	280 + 40
		1 k - 5 k	440 + 100	460 + 100	480 + 100	500 + 100	420 + 100	440 + 100
		5 k - 10 k	6000 + 200	7000 + 200	7500 + 200	8000 + 200	6000 + 200	7000 + 200
5725A Amplifier:								
11 A	100 μA	40 - 1 k	370 + 170	400 + 170	440 + 170	460 + 170	300 + 170	330 + 170
		1 k - 5 k	800 + 380	850 + 380	900 + 380	950 + 380	700 + 380	800 + 380
		5 k - 10 k	3000 + 750	3300 + 750	3500 + 750	3600 + 750	2800 + 750	3200 + 750

Note:
Maximum output from the calibrator's terminals is 2.2 A. Specifications for 220 μA and 2.2 mA ranges are increased by a factor of 1.3 plus 2 μA when supplied through 5725A terminals.

5730A AC Current Specifications: 95 % Confidence Level

Range	Resolution	Frequency (Hz)	Absolute / ± 5 °C from calibration temperature				Relative ± 1 °C	
			24 Hours	90 Days	180 Days	1 Year	24 Hours	90 Days
			$\pm(\text{ppm output} + \text{nA})$					
220 μA	1 nA	10 - 20	210 + 16	230 + 16	240 + 16	250 + 16	210 + 16	230 + 16
		20 - 40	130 + 10	140 + 10	150 + 10	160 + 10	110 + 10	130 + 10
		40 - 1 k	96 + 8	99 + 8	101 + 8	103 + 8	80 + 8	90 + 8
		1 k - 5 k	240 + 12	250 + 12	270 + 12	280 + 12	200 + 12	230 + 12
		5 k - 10 k	800 + 65	900 + 65	1000 + 65	1100 + 65	700 + 65	800 + 65
2.2 mA	10 nA	10 - 20	210 + 40	230 + 40	240 + 40	250 + 40	210 + 40	230 + 40
		20 - 40	130 + 35	140 + 35	150 + 35	160 + 35	110 + 35	130 + 35
		40 - 1 k	96 + 35	99 + 35	101 + 35	103 + 35	80 + 35	90 + 35
		1 k - 5 k	170 + 110	180 + 110	190 + 110	200 + 110	160 + 110	170 + 110
		5 k - 10 k	800 + 650	900 + 650	1000 + 650	1100 + 650	700 + 650	800 + 650
22 mA	100 nA	10 - 20	210 + 400	230 + 400	240 + 400	250 + 400	210 + 400	230 + 400
		20 - 40	130 + 350	140 + 350	150 + 350	160 + 350	110 + 350	130 + 350
		40 - 1 k	96 + 350	99 + 350	101 + 350	103 + 350	80 + 350	90 + 350
		1 k - 5 k	170 + 550	180 + 550	190 + 550	200 + 550	160 + 550	170 + 550
		5 k - 10 k	800 + 5000	900 + 5000	1000 + 5000	1100 + 5000	700 + 5000	800 + 5000
$\pm(\text{ppm output} + \mu\text{A})$								
220 mA	1 μA	10 - 20	210 + 4	230 + 4	240 + 4	250 + 4	210 + 4	230 + 4
		20 - 40	130 + 3.5	140 + 3.5	150 + 3.5	160 + 3.5	110 + 3.5	130 + 3.5
		40 - 1 k	96 + 2.5	99 + 2.5	101 + 2.5	103 + 2.5	80 + 2.5	90 + 2.5
		1 k - 5 k	170 + 3.5	180 + 3.5	190 + 3.5	200 + 3.5	160 + 3.5	170 + 3.5
		5 k - 10 k	800 + 10	900 + 10	1000 + 10	1100 + 10	700 + 10	800 + 10
2.2 A	10 μA	20 - 1 k	214 + 35	224 + 35	234 + 35	244 + 35	200 + 35	230 + 35
		1 k - 5 k	350 + 80	390 + 80	420 + 80	450 + 80	300 + 80	350 + 80
		5 k - 10 k	5000 + 160	6000 + 160	6500 + 160	7000 + 160	5000 + 160	6000 + 160
5725A Amplifier:								
11 A	100 μA	40 - 1 k	370 + 170	400 + 170	440 + 170	460 + 170	300 + 170	330 + 170
		1 k - 5 k	800 + 380	850 + 380	900 + 380	950 + 380	700 + 380	800 + 380
		5 k - 10 k	3000 + 750	3300 + 750	3500 + 750	3600 + 750	2800 + 750	3200 + 750

Note:
Maximum output from the calibrator's terminals is 2.2 A. Specifications for 220 μA and 2.2 mA ranges are increased by 1.3 plus 2 μA when supplied through 5725A terminals.

AC Current Secondary Performance Specifications and Operating Characteristics

Range	Frequency (Hz)	Stability $\pm 1^\circ\text{C}$ ^[1] 24 Hours $\pm(\text{ppm output} + \text{nA})$	Temperature Coefficient ^[2]		Compliance Limits (V rms)	Maximum Resistive Load For Published Specification ^[3] (Ω)	Noise and Distortion (Bandwidth 10 Hz - 50 kHz <0.5V Burden) $\pm(\% \text{ output} + \mu\text{A})$
			10 - 40 $^\circ\text{C}$	0 - 10 $^\circ\text{C}$ and 40 - 50 $^\circ\text{C}$			
			$\pm(\text{ppm output} + \text{nA})/^\circ\text{C}$				
220 μA	10 - 20	150 + 5	50 + 5	50 + 5	7	2 k	0.05 + 0.1
	20 - 40	80 + 5	20 + 5	20 + 5			0.05 + 0.1
	40 - 1 k	30 + 3	4 + 0.5	10 + 0.5			0.05 + 0.1
	1 k - 5 k	50 + 20	10 + 1	20 + 1			0.25 + 0.5
	5 k - 10 k	400 + 100	20 + 100	20 + 100			0.05 + 1
2.2 mA	10 - 20	150 + 5	50 + 5	50 + 5	7	800	0.05 + 0.1
	20 - 40	80 + 5	20 + 4	20 + 4			0.05 + 0.1
	40 - 1 k	30 + 3	4 + 1	10 + 2			0.05 + 0.1
	1 k - 5 k	50 + 20	10 + 100	20 + 100			0.25 + 0.5
	5 k - 10 k	400 + 100	50 + 400	50 + 400			0.05 + 1
22 mA	10 - 20	150 + 50	50 + 10	50 + 10	7	80	0.05 + 0.1
	20 - 40	80 + 50	20 + 10	20 + 10			0.05 + 0.1
	40 - 1 k	30 + 30	4 + 10	10 + 20			0.05 + 0.1
	1 k - 5 k	50 + 500	10 + 500	20 + 400			0.25 + 0.5
	5 k - 10 k	400 + 1000	50 + 1000	50 + 1000			0.05 + 1
	Hz	$\pm(\text{ppm output} + \mu\text{A})$	$\pm(\text{ppm output} + \mu\text{A})/^\circ\text{C}$				
220 mA	10 - 20	150 + 0.5	50 + 0.05	50 + 0.05	7	8	0.05 + 10
	20 - 40	80 + 0.5	20 + 0.05	20 + 0.05			0.05 + 10
	40 - 1 k	30 + 0.3	4 + 0.1	10 + 0.1			0.05 + 10
	1 k - 5 k	50 + 3	10 + 2	20 + 2			0.25 + 50
	5 k - 10 k	400 + 5	50 + 5	50 + 5			0.05 + 100
2.2 A	20 - 1 k	50 + 5	4 + 1	10 + 1	1.4 ^[4]	0.8	0.5 + 100
	1 k - 5 k	80 + 20	10 + 5	20 + 5			0.3 + 500
	5 k - 10 k	800 + 50	50 + 10	50 + 10			1 + 1 mA
5725A Amplifier:							$\pm(\% \text{ output})$
11 A	40 - 1 k	75 + 100	20 + 75	30 + 75	3	3	0.05 ^[5]
	1 k - 5 k	100 + 150	40 + 75	50 + 75			0.12 ^[5]
	5 k - 10 k	200 + 300	100 + 75	100 + 75			0.5 ^[5]

Notes:

Maximum output from 5730A terminals is 2.2 A. Specifications for 220 μA and 2.2 mA ranges are increased by a factor of 1.3, plus 2 μA when supplied through 5725A terminals. Specifications are otherwise identical for all output locations.

- Stability specifications are included in the Absolute values for the primary specifications.
- Temperature coefficient is an adder to specifications that does not apply unless operating more than $\pm 5^\circ\text{C}$ from calibration temperature.
- For larger resistive loads multiply accuracy specifications by: $\left(\frac{\text{actual load}}{\text{maximum load for published specification}} \right)^2$
- 1.5 V compliance limit above 1 A. 5725A Amplifier may be used in range-lock mode down to 1 A.
- For resistive loads within rated compliance voltage limits.

Minimum Output	9 μ A for 220 μ A range, 10 % on all other ranges. 1 A minimum for 5725A.
Inductive Load Limits	400 μ H (5730A, or 5725A). 20 μ H for 5730A output >1 A.
Power Factors	5730A, 0.9 to 1; 5725A, 0.1 to 1. Subject to compliance voltage limits.
Frequency	
Range (Hz)	10.000 - 11.999, 12.00 - 119.99, 120.0 - 1199.9, 1.200 k - 10.000 k
Specification	\pm 0.01 % of output
Resolution	11,999 counts
Settling Time	5 seconds for 5730A ranges; 6 seconds for 5725A 11 A range; +1 second for amplitude or frequency range change.
Overshoot	<10 %

Wideband AC Voltage (Option 5730A/03 and 5730A/05) Specifications (99 % Confidence Level)

Specifications apply to the end of the cable and 50 Ω termination used for calibration.

Range		Resolution	Absolute / ± 5 $^{\circ}$ C from calibration temperature 30 Hz - 500 kHz			
Volts	dBm		24 Hours	90 Days	180 Days	1 Year
\pm (% output + μ V)						
1.1 mV	-46	10 nV	0.4 + 0.4	0.5 + 0.4	0.6 + 0.4	0.8 + 2
3.3 mV	-37	10 nV	0.4 + 1	0.45 + 1	0.5 + 1	0.7 + 3
11 mV	-26	100 nV	0.2 + 4	0.35 + 4	0.5 + 4	0.7 + 8
33 mV	-17	100 nV	0.2 + 10	0.3 + 10	0.45 + 10	0.6 + 16
110 mV	-6.2	1 μ V	0.2 + 40	0.3 + 40	0.45 + 40	0.6 + 40
330 mV	+3.4	1 μ V	0.2 + 100	0.25 + 100	0.35 + 100	0.5 + 100
1.1 V	+14	10 μ V	0.2 + 400	0.25 + 400	0.35 + 400	0.5 + 400
3.5 V	+24	10 μ V	0.15 + 500	0.2 + 500	0.3 + 500	0.4 + 500

Frequency (Hz)	Frequency Resolution (Hz)	Amplitude Flatness, 1 kHz Reference Voltage Range			Temperature Coefficient \pm ppm/ $^{\circ}$ C	Settling Time To Published Specification (Seconds)	Harmonic Distortion (dB)
		1.1 mV	3.3 mV	>3.3 mV			
\pm (% output + floor indicated)							
10 - 30	0.01	0.3	0.3	0.3	100	7	-40
30 - 119.99	0.01	0.1	0.1	0.1	100	7	-40
120 - 1.1999 k	0.1	0.1	0.1	0.1	100	5	-40
1.2 k - 11.999 k	1	0.1	0.1	0.1	100	5	-40
12 k - 119.99 k	10	0.1	0.1	0.1	100	5	-40
120 k - 1.1999 M	100	0.2 + 3 μ V	0.1 + 3 μ V	0.1 + 3 μ V	100	5	-40
1.2 M - 2 M ^[1]	1 k	0.2 + 3 μ V	0.1 + 3 μ V	0.1 + 3 μ V	100	0.5	-40
2 M - 11.9 M	1 k	0.4 + 3 μ V	0.3 + 3 μ V	0.2 + 3 μ V	100	0.5	-40
12 M - 20 M	10 k	0.6 + 3 μ V	0.5 + 3 μ V	0.4 + 3 μ V	150	0.5	-34
20 M - 30 M	10 k	1.5 + 15 μ V	1.5 + 3 μ V	1 + 3 μ V	300	0.5	-34
30 M - 50 M ^[2]	10 k	3.0 + 15 μ V	3.0 + 3 μ V	2.0 + 3 μ V	600	0.5	-34

Note:
1. For output voltages <50 % of full range in the 33 mV, 110 mV, 330 mV, 1.1 V, and 3.5 V ranges, add 0.1 % to the amplitude flatness specification.

Additional Operating Information:

dBm reference = 50 Ω

Range boundaries are at voltage points, dBm levels are approximate.

$$\text{dBm} = 10 \log \left(\frac{\text{Power}}{1\text{mW}} \right); 0.22361 \text{ V across } 50 \Omega = 1 \text{ mW or } 0 \text{ dBm}$$

2. Applies to Option 5730A/05 only.

Minimum Output	300 μ V (-57 dBm)
VSWR at Output Terminal	<1.1 Typical
Frequency Specification	\pm 0.01 % of output
Frequency Resolution	11,999 counts to 1.1999 MHz, 10799 counts to 11.999 MHz, 3800 counts to 50 MHz
Overload Protection	A short circuit on the wideband output will not result in damage. After settling time, normal operation is restored upon removal.

52120A Specifications when Operated with the 5730A

Line Power

Voltage range	100 V to 240 V
Frequency	47 to 63 Hz
Voltage variations	\pm 10 % about line voltage
Power consumption	<1500 VA

Dimensions (HxWxL)

With feet.....	192 mm x 432 mm x 645 mm (7.6 in x 17.0 in x 25.5 in)
Without feet.....	178 mm x 432 mm x 645 mm (7.0 in x 17.0 in x 25.5 in)

Weight 25 kg (54 lb)

Temperature

Operating	5 $^{\circ}$ C to 35 $^{\circ}$ C (41 $^{\circ}$ F to 95 $^{\circ}$ F)
Calibration (tcal).....	16 $^{\circ}$ C to 30 $^{\circ}$ C (61 $^{\circ}$ F to 86 $^{\circ}$ F)
Storage	0 $^{\circ}$ C to 50 $^{\circ}$ C (32 $^{\circ}$ F to 122 $^{\circ}$ F)
Transit.....	-20 $^{\circ}$ C to +60 $^{\circ}$ C (-4 $^{\circ}$ F to +140 $^{\circ}$ F) <100 hours

Warmup Time Twice the time since last warmed up, to a maximum of 1 hour.

Humidity (non-condensing)

Operating	<80 %, 5 $^{\circ}$ C to 31 $^{\circ}$ C (41 $^{\circ}$ F to 88 $^{\circ}$ F) ramping linearly down to 50 % at 35 $^{\circ}$ C (95 $^{\circ}$ F)
Storage	<95 %, 0 to 50 $^{\circ}$ C (32 $^{\circ}$ F to 122 $^{\circ}$ F)

Altitude

Operating	2,500 m (8,200 ft) maximum
Non-Operating	12,000 m (39,400 ft) maximum

Shock and Vibration MIL-PRF-28800F Class 3

Safety EN/IEC 61010-1, 300 V CAT II, Pollution Degree 2

Electromagnetic Environment IEC 61326-1, Industrial

Electromagnetic Compatibility FCC Rules part 15 sub part B

Applies to use in Korea only. Class A Equipment (Industrial Broadcasting & Communication Equipment)^[1]

[1] This product meets requirements for industrial (Class A) electromagnetic wave equipment and the seller or user should take notice of it. This equipment is intended for use in business environments and is not to be used in homes.

Indoor use only IP20

52120A Electrical Performance Limits

Voltage compliance developed across inductive loads may prevent range maximum current output being achieved at higher frequencies. The appropriate maximum frequency (F_{max}) for a given load inductance and current is given by:

$$F_{max} = \frac{4.5}{2 \cdot \pi \cdot I \cdot L} \quad \begin{array}{l} I = \text{Current} \\ L = \text{Total} \\ \text{inductance} \end{array}$$

The maximum frequency calculated with this equation is only approximate. Series resistance and parallel capacitance also affect the maximum achievable frequency.

Input Common Mode Rejection 80 dB @ DC decreasing linearly to 40 dB at 10 kHz

Input Impedance

Voltage input.....	>1 M Ω
Current input	10 Ω

Maximum Output Compliance Voltage 4.5 V rms (6.4 V pk), 6.4 V dc. 120 A range maximum compliance voltage decreases from 4.5 V at 1 kHz to about 3 V at 10 kHz

DC Offset Magnetic remanence that follows abrupt changes in output current level may cause small changes to DC current offset. It is good practice to correct for offsets in DC measurements and techniques such as DC reversal measurement will result in best accuracy.

Operated within 5730A Control Loop (all current ranges)

The current specification of the 52120A, when controlled by a single 5730A, applies to the parallel output of up to three 52120As connected as slaves.

Coverage factor $k=2.58$ (99 % confidence level)

Current Specification

Frequency	1-year, $t_{cal}^{[1]} \pm 5^\circ\text{C} \pm(\% \text{ of output} + \% \text{ of range})$	
	5730A	
	% of output	% of range
DC	0.015	0.010
10 Hz to 850 Hz	0.011	0.003
850 Hz to 6 kHz	0.052	0.005
6 kHz to 10 kHz	See Operated Stand Alone current specification table in the 52120A Users Manual.	
Notes:		
1. t_{cal} is the temperature at which calibration adjustment took place.		
Maximum inductance for stability LCOMP OFF is 100 μH . Maximum inductance for stability LCOMP ON is 400 μH for 2 A and 20 A ranges. 100 μH on the 120 A range.		
With LCOMP ON, the output is limited to 7.2e3 A-Hz. For example, a 100 A output is limited to 72 Hz.		

Coverage factor $k=2.00$ (95 % confidence level)

Current Specification

Frequency	1-year, $t_{cal}^{[1]} \pm 5^\circ\text{C} \pm(\% \text{ of output} + \% \text{ of range})$	
	5730A	
	% of output	% of range
DC	0.012	0.008
10 Hz to 850 Hz	0.009	0.002
850 Hz to 6 kHz	0.040	0.004
6 kHz to 10 kHz	See Operated Stand Alone current specification table in the 52120A Users Manual.	
Notes:		
1. t_{cal} is the temperature at which calibration adjustment took place.		
Maximum inductance for stability LCOMP OFF is 100 μH . Maximum inductance for stability LCOMP ON is 400 μH for 2 A and 20 A ranges. 100 μH on the 120 A range.		
With LCOMP ON, the output is limited to 7.2e3 A-Hz. For example, a 100 A output is limited to 72 Hz.		

Maximum Distortion and Noise

Frequency	Distortion ^[1]				Noise 16 Hz to 10 MHz
	LCOMP OFF		LCOMP ON		
	dBc	Current	dBc	Current	
2 Amp Range					
16 Hz to 850 Hz	-76	42 μ A	-70	83 μ A	-60 dB
850 Hz to 6 kHz	-52	662 μ A	-46	1.3 mA	-60 dB
6 kHz to 10 kHz ^[2]	-40	2.6 mA	-35	4.7 mA	-60 dB
20 Amp Range					
16 Hz to 850 Hz	-76	418 μ A	-60	2.6 mA	-70 dB
850 Hz to 6 kHz	-52	6.6 mA	-42	20.9 mA	-70 dB
6 kHz to 10 kHz ^[2]	-40	26.4 mA	-35	46.9 mA	-70 dB
120 Amp Range					
16 Hz to 850 Hz	-76	2.5 mA	-60	15.8 mA	-70 dB
850 Hz to 6 kHz	-52	39.7 mA	-42	125.7 mA	-70 dB
6 kHz to 10 kHz ^[2]	-40	158.2 ma	-35	281.3 mA	-70 dB
Notes:					
1. Use dB or Current. Whichever is larger.					
2. Interharmonics only above 6 kHz.					

52120A/COIL 3 kA 25-Turn Coil

Number of Turns 25

Minimum internal jaw dimension to clear wires 26 mm (width) x 36 mm (length)

Maximum Input Current 120 A continuous with built-in 12 V fan on

Maximum Voltage 4.5 V rms

Specification

Input Current ^[1]	Frequency	Effective Current Amp-turns	52120A + Coil Specification ^[2] \pm (% of Amp-turns + % of 52120A range)	
			% of Amp-turns	% of 52120A Range
0 A to 100 A	DC	0 to 2500	0.7 %	0.7 %
0 A to 120 A	10 Hz to 65 Hz	0 to 3000	0.7 %	0.7 %
0 A to 120 A	65 Hz to 300 Hz	0 to 3000	0.7 %	0.7 %
0 A to 40 A	300 Hz to 1 kHz	0 to 1000	0.7 %	0.7 %
0 A to 12 A	1 kHz to 3 kHz	0 to 300	0.8 %	1.0 %
0 A to 3 A	3 kHz to 6 kHz	0 to 75	1.5 %	1.0 %
0 A to 1 A	6 kHz to 10 kHz	0 to 25	5.0 %	1.0 %
Notes:				
1. The inductance and mutual inductance of the 25 turn coil and clamp that is measured causes a frequency dependent compliance voltage across the coil. The length and configuration of the cables that connect the current to the coil also have an effect. Maximum input current is 120 A input at approximately 100 Hz. Maximum current input decreases to approximately 0.8 A at 10 kHz.				
2. Includes coil/clamp interaction.				

52120A/COIL 6 kA 50-Turn Coil

Number of Turns 50
Minimum Flexible Probe Length..... 500 mm
Maximum Input Current..... 120 A continuous with built-in 12 V fan on
Maximum Voltage 4.5 V rms

Specification

Input Current ^[1]	Frequency	Effective Current Amp-turns	52120A + Coil Specification ^[2] ±(% of Amp-turns + % of 52120A range)	
			% of Amp-turns	% of 52120A Range
0 A to 100 A	DC	0 to 5000	0.7 %	0.7 %
0 A to 120 A	10 Hz to 65 Hz	0 to 6000	0.7 %	0.7 %
0 A to 120 A	65 Hz to 300 Hz	0 to 6000	0.7 %	0.7 %
0 A to 120 A	300 Hz to 1 kHz	0 to 6000	0.7 %	0.7 %
0 A to 120 A	1 kHz to 3 kHz	0 to 6000	0.8 %	1.0 %
0 A to 25 A	3 kHz to 6 kHz	0 to 1250	1.5 %	1.0 %
0 A to 13 A	6 kHz to 10 kHz	0 to 650	5.0 %	1.0 %

Notes:
1. The inductance and mutual inductance of the 50 turn coil causes a frequency dependent compliance voltage across the coil. Maximum frequency for 120 A input current is approximately 600 Hz. Maximum current input decreases to approximately 13 A at 10 kHz.
2. Includes coil/probe interaction.

Note

The specifications for these coils are at 99 % confidence level and are the combined specification of the coil and a 52120A. If the coils are used with other current sources the calibration specification of the coils alone is 0.65 % (99 % confidence level) from 0 Hz to 10 kHz.

Operating Limits

	Output Current Range		
	2 A	20 A	120 A
Current Output (Max.)	2 A rms	20 A rms	120 A rms
	Current Input		
Input Current (Max.)	200 mA rms	200 mA rms	120 mA rms
Current gain	10	100	1,000
	Voltage Input		
Input Voltage (Max.)	2 V rms	2 V rms	1.2 V rms
Transconductance	1 Siemen	10 Siemens	100 Siemens

120 A Range Current/Frequency Limits

Frequency	Maximum Output Current	Maximum Current Input	Maximum Voltage Input
DC	±100 A	±100 mA	±1.0 V
<10 Hz	100 A pk (70 A rms)	100 mA pk (70 mA rms)	1.0 V pk (0.7 V rms)
10 Hz to 10 kHz	170 A pk (120 A rms)	170 mA pk (120 mA rms)	1.7 V pk (1.2 V rms)

Note:
The 2 A and 20 A ranges operate at full output current from DC to 10 kHz.

Output Isolation

Frequency	Maximum Voltage Signal Applied to any Output Current Terminal with respect to Earth
DC to 850 Hz	600 V rms, 850 V pk, limited 2 A rms, no transient overvoltages
850 Hz to 3 kHz	100 V rms, 142 V pk, limited 2 A rms, no transient overvoltages
3 kHz to 10 kHz	33 V rms, 47 V pk, limited 2 A rms, no transient overvoltages

Chapter 2

Installation

Introduction

Warning

**The Product can supply lethal voltages to the binding posts.
Read this chapter before you use the Product.**

This chapter has instructions to unpack and install the 5730A Calibrator. The procedures for line voltage selection and connection to mains power are provided here.

Instructions for cable connections, other than line power connection, can be found in these chapters of the manual:

- UUT (Unit Under Test) connections: Chapter 4
- Remote interface connection (IEEE-488/RS-232/USB/LAN): Chapter 5
- Option 5730/03 and 5730/05 Wideband AC Module connection: Chapter 4
- Auxiliary amplifier connections: Chapter 4

Unpack and Inspect the Calibrator

The 5730A Calibrator ships in a container that prevents shipping damage. Inspect the Calibrator carefully for damage, and immediately report any damage to the shipper. Instructions for inspection and claims are included in the shipping container.

When the Calibrator is unpacked, check for all the standard equipment listed in Table 2-1 and check the shipping order for additional items ordered. See Chapter 8 for information about options and accessories. Report any shortage to the place of purchase or to the nearest Fluke Calibration Service Center. See “How to Contact Fluke Calibration” if necessary. If performance tests are necessary for your acceptance procedure, they can be found in Chapter 7.

If it is necessary to reship the Calibrator, use the original container. A new container can be ordered from Fluke Calibration. See “How to Contact Fluke Calibration” if necessary.

Table 2-1. Standard Equipment

Item	Model or Part Number
Calibrator	5730A
Mains Power Cord	See Table 2-2 and Figure 2-1
5730A Getting Started	4290571
5730A Manual CD (Containing the Operators Manual)	4290580
Certificate of Calibration	No part number

Placement and Rack Mounting

Put the 5730A Calibrator on top of a bench or mount in a standard-width, 24-inch (61-cm) deep equipment rack. For bench-top use, the Calibrator has non-slipping, non-marring feet. To mount the Calibrator in an equipment rack, use the Rack Mount Kit (Model Y5737) or the Rack Ear Kit (Model Y5738). Instructions are included with the kit.

Warnings

To prevent possible electrical shock, fire, or personal injury, do not restrict access to the Calibrator mains power cord. The mains power cord is the mains disconnecting device. If access to the power cord is inhibited by rack mounting, a properly-rated accessible mains disconnecting switch must be provided within reach as part of the installation.

Cooling Considerations

Caution

Damage caused by overheating can occur if the area around the air intake is restricted, the intake air is too warm, or the air filter becomes clogged.

Adhere to these rules to lengthen the life of the 5730A Calibrator and enhance its performance:

- The area around the air filter must be at least 3 inches from nearby walls or rack enclosures.
- The exhaust perforations on the sides of the Calibrator must be clear of obstructions.
- The air that enters the Calibrator must be room temperature. Make sure that exhaust from another instrument is not directed into the fan inlet.
- Clean the air filter every 30 days or more frequently if the Calibrator is operated in a dusty environment. Instructions for cleaning the air filter are in Chapter 7.

Mains Voltage Selection

The 5730A Calibrator automatically detects the main line voltage when the soft power switch is pushed and configures itself to work at that voltage level. Nominal mains voltages ranging from 100 Vrms -120 Vrms and from 220 Vrms -240 Vrms ($\pm 10\%$) are acceptable, with frequencies from 47 Hz to 63 Hz.

⚠⚠ Warnings

To prevent possible electrical shock, fire, or personal injury, the mains fuse must be selected to match the input voltage. While the product automatically detects the mains line voltage, the fuse must be manually selected. See Table 7-1 for replacement fuses.

The Calibrator comes with the appropriate line power plug for the country of purchase. If a different type is necessary, refer to Table 2-2 and Figure 2-1. They list and show the mains line power plug types available from Fluke Calibration.

Table 2-2. Line Power Cord Types Available from Fluke Calibration

Type	Fluke Option Number
North America	LC-1
Universal Euro	LC-3
United Kingdom	LC-4
Switzerland	LC-5
Australia	LC-6
South Africa	LC-7
Brazil	LC-42

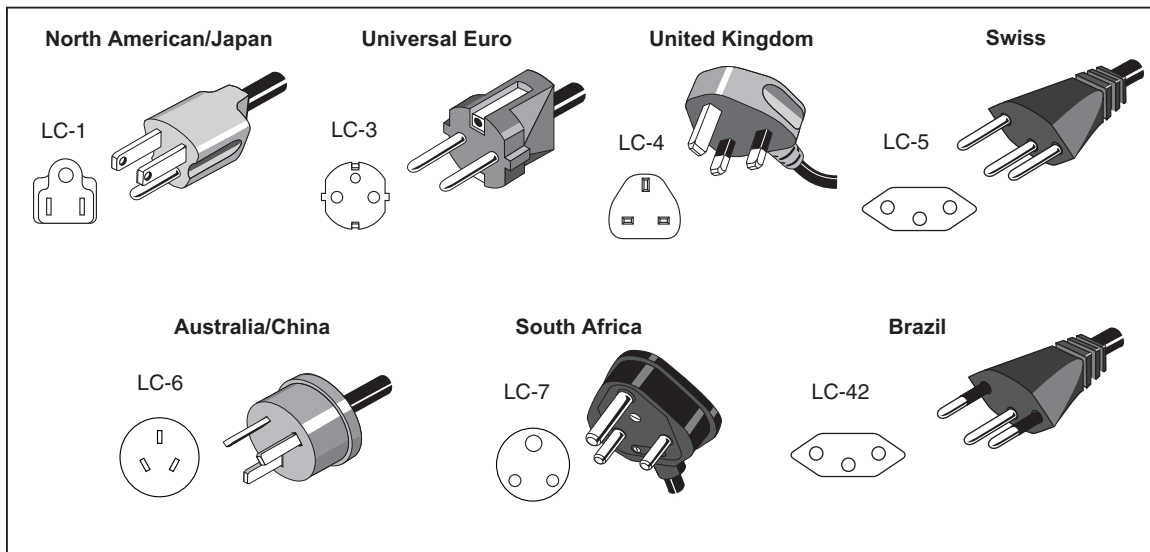

Figure 2-1. Available Mains Power Cord Types

hhp004.eps

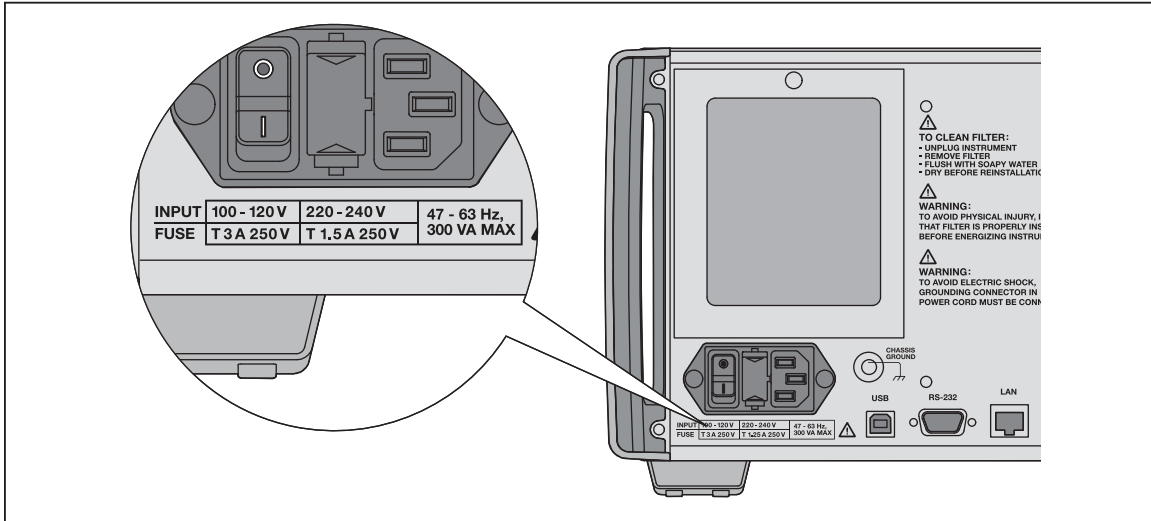

Figure 2-2. Line Power Label and Switch Location

hhp005.eps

Connect to Mains Power

Warning

To prevent shock hazard, connect the factory-supplied three-conductor mains power cord to a properly-grounded power outlet. Do not use a two-conductor adapter or extension cord, as it will break the protective ground connection. If a two-conductor mains power cord must be used, a protective grounding wire must be connected between the ground terminal and earth ground before you connect the mains power cord or operate the Product.

Connect a 5725A Amplifier

The 5730A Calibrator provides an interface connector for the Fluke 5725A Amplifier. Designate the active amplifier for voltage and current boost in the Setup Menu, as detailed in Chapter 4. Refer to the *5725A Instruction Manual* for the installation procedure.

Connect a 52120A Amplifier

The 5730A Calibrator provides an interface connector for the Fluke 52120A Transconductance Amplifier. Designate the active amplifier for current boost in a Setup Menu, as detailed in Chapter 4. Refer to the *52120A Users Manual* for the installation procedure.

Chapter 3 Features

Introduction

This chapter is a reference for the functions and locations of the front and rear panel features. It also provides descriptions of each feature. Read this information before the 5730A Calibrator is used. Front-panel operation instructions for the Calibrator are in Chapter 4. Remote operation instructions are in Chapter 6.

Front-Panel Features

Front-panel features (including all controls, displays, indicators, and terminals) are shown in Figure 3-1. Each front-panel feature is briefly described in Table 3-1.

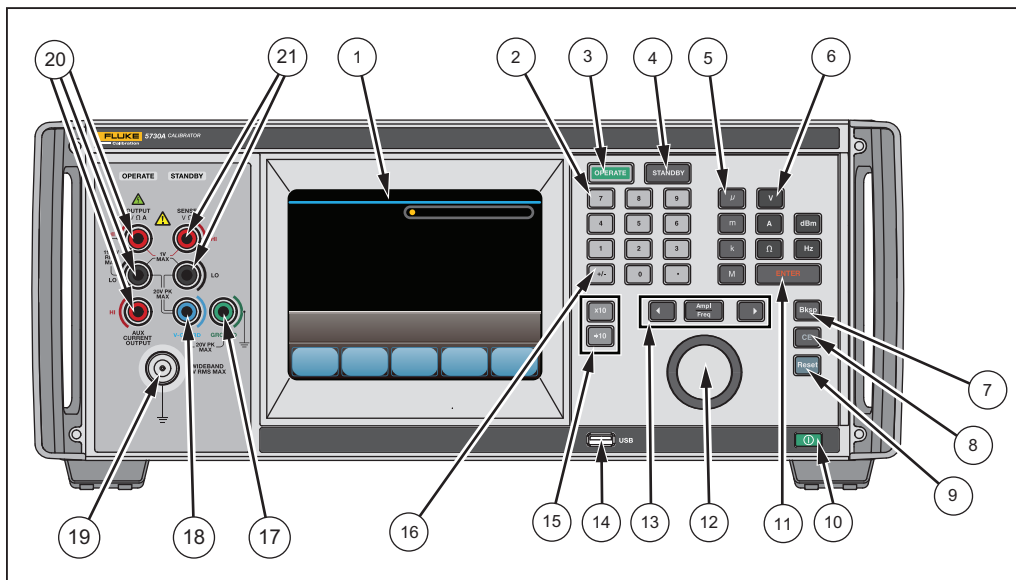

Figure 3-1. Front-Panel Features

hhp006.eps

Table 3-1. Front-Panel Features

Item	Description
①	The color touch-sensitive display shows the output amplitude, frequency, and other active conditions and messages. The display provides controls not available with the keys alone. The Calibrator interface is made up of multiple menus, described in Chapter 4.
②	Numbered keys to enter the output amplitude, frequency, and other data such as the time and date. To enter a value, push the digits of the output value, a multiplier key (if necessary), and an output function key. Then push ENTER . For example, for an output of 20 mV, push 2 0 m V ENTER .
③ OPERATE	OPERATE activates the programmed output.
④ STANDBY	STANDBY deactivates the programmed output. The output automatically changes to STANDBY if: <ul style="list-style-type: none"> • Reset is pushed • The output voltage is changed from <22 V to >22 V • The output location changes • The output function changes. An exception to this is that the output stays operational when functions are changed between ac and dc voltage.
⑤	Multiplier keys to select output value multipliers. For example, if 3 3 m V ENTER is entered, the Calibrator output value is 33 mV. The multiplier keys are: <ul style="list-style-type: none"> • μ micro (10^{-6}) • m milli (10^{-3}) • k kilo (10^3) • M mega (10^6)
⑥	Output function keys. The output functions are: <ul style="list-style-type: none"> • dBm Decibels relative to 1 mW • V Voltage • A Current • Ω Resistance • Hz Frequency When Hz is entered, the Calibrator automatically switches to ac. When a new signed (+ or -) output value is entered without specifying Hz, the Calibrator automatically switches back to dc.
⑦ Bksp	Backspace (Bksp) key. As a new output value is entered, use this key to delete the last key entry.
⑧ CE	The CE (Clear Entry) key clears a value entry in progress.
⑨ Reset	The Reset key returns the Calibrator to its initial power-up state.
⑩	Power button. Push the lighted power button to turn on or off the Calibrator.
⑪ ENTER	The ENTER key changes the output value just keyed in with the numerical, multiplier, and output function keys explained above.

Table 3-1. Front-Panel Features (cont.)













Item	Description
⑫	Turn the Edit knob to the right to increase the output value of the active-edit digit. Turn the Edit knob to the left to decrease the output value of the active-edit digit.
⑬ 	<p>Error mode / edit keys</p> <ul style="list-style-type: none">  moves the active-edit digit one decimal place to the left.  switches the active-edit field between the amplitude and frequency.  moves the active-edit digit one decimal place to the right.
⑭	Front USB port. Calibration report data can be saved to a flash drive inserted into this port. The Calibration report process is explained in Chapter 7.
⑮ 	<p>Multiplier keys</p> <ul style="list-style-type: none">  - multiplies the present output by 10.  - divides the present output by 10.
⑯ 	Invert output key. If the output function is dc voltage, current, ac voltage entered in dBm, or a wideband output entered in dBm, push   to toggle the polarity of the output. If the output function is ac voltage or current, push   to change the output to dc.
⑰ GROUND Binding Post	If the Calibrator is the location of the ground reference point in a system, the GROUND binding post can be used to connect other instruments to earth ground. The chassis is normally connected to earth ground through the three-conductor line cord instead of through the earth ground binding post. Refer to "Cable Connection Instructions" in Chapter 4 for details. Included with the Calibrator is a brass strap that connects GROUND to V GUARD.
⑱ V GUARD Binding Post ^[1]	The V GUARD binding post provides an external connection point for the internal voltage guard. For a UUT with floating (ungrounded) inputs, the V GUARD should be connected to LO internally (External Guard OFF). For a UUT with a grounded input, the V GUARD must be externally connected to the grounded UUT input (External Guard on). The maximum allowable potential between the V GUARD connector and chassis ground is 20 V peak. Refer to "When to use the External Voltage Guard" and "Cable Connection Instructions" in Chapter 4 for details.
⑲ WIDEBAND Connector ^[1]	The WIDEBAND connector is a Type "N" connector that provides a connection point for output from the Option 5730A/03 or 5730/05 Wideband AC Module. Wideband output specifications are stated for output levels present at the end of its 3-foot 50 Ω coaxial cable terminated into a 50 Ω purely resistive load. The connector shell is connected to chassis ground. Refer to Chapter 4 for connecting and operating instructions for the wideband module.

Table 3-1. Front-Panel Features (cont.)

Item	Description
<p style="text-align: center;">(20) OUTPUT Binding Posts^[1]</p>	<p>Connection points for ac and dc current and voltage output, and resistance. The function of each OUTPUT binding post is defined below:</p> <p>LO</p> <p>The common binding post for all output functions including 5725A amplified voltage output, but not Option 5730A/03 or 5730/05 Wideband AC or other auxiliary amplifier output.</p> <p>HI</p> <p>The active binding post for all output functions including 5725A amplified voltage output, but not Option 5730A/03 or 5730/05 Wideband AC or other auxiliary amplifier output.</p> <p>AUX CURRENT OUTPUT</p> <p>An optional active binding post for current. It is convenient to use the AUX CURRENT OUTPUT binding post when calibrating a UUT with a separate current input terminal. Refer to "Connect the Calibrator to the UUT" in Chapter 4 for instructions for use of this binding post.</p>
<p style="text-align: center;">(21) SENSE Binding Posts^[1]</p>	<p>The SENSE binding post is used with resistance and voltage functions for sensing at the UUT after the external sense has been selected by the touch of External Sense or by remote command.</p> <p>External sensing should be used in the dc voltage function when the UUT draws enough current to produce a significant voltage drop in the cables, and in the resistance function when the UUT has a four-wire ohms input and the Calibrator is set to 100 kΩ or less. External sensing can also be used in the two-wire ohms function to allow the two-wire compensation circuitry to the UUT terminals. Refer to "When to use External Sensing," "Four-Wire Vs. Two-Wire Resistance Connections," and "Cable Connection Instructions" in Chapter 4 for external sensing instructions and illustrations of SENSE connections.</p>
<p>[1] Visual Connection Management Terminals. The appropriate terminals light up in green when ENTER is pushed, whether in STANDBY or OPERATE. The terminals offer visual guidance for cable connections for specific functions, protect the user by indicating which terminals are active, and protecting the calibrator from damage from incorrect connections.</p>	

Rear-Panel Features

Rear-panel features (including all terminals, sockets, and connectors) are shown in Figure 3-2. Each rear-panel feature is briefly described in Table 3-2.

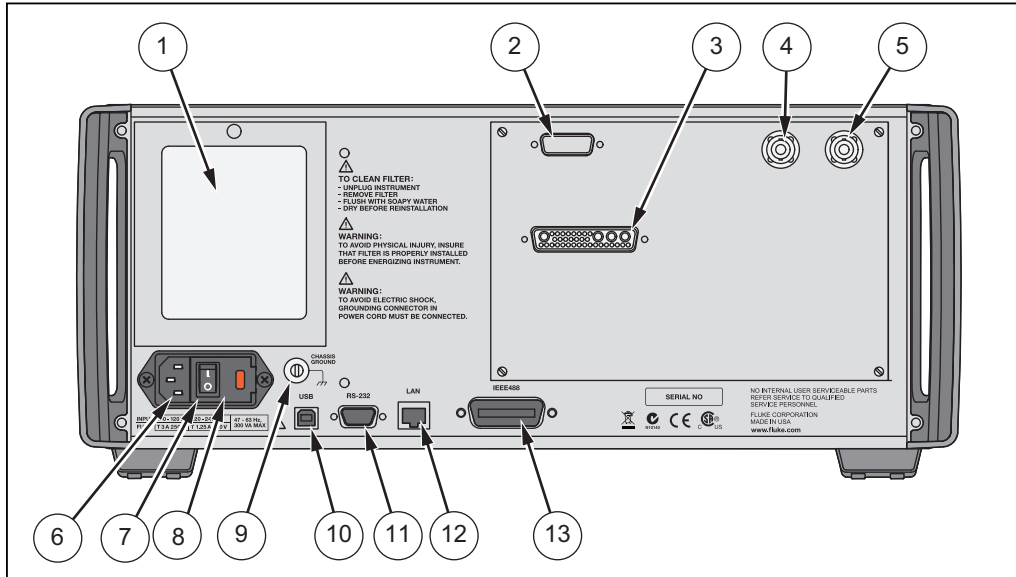

hhp009.eps

Figure 3-2. Rear-Panel Features

Table 3-2. Rear-Panel Features

Item	Description
① Fan Filter	The filter covers the air intake to keep dust and debris out of chassis. Fans inside the Calibrator provide a constant cooling air flow throughout the chassis. Circuitry inside the Calibrator monitors correct operation of the internal fans.
② 52120A Transconductance Amplifier Connector	Provides the analog and digital interface for the Fluke 52120A Transconductance Amplifier. After the 52120A is connected to the 52120A AMPLIFIER connector, control the 52120A from the Calibrator front panel or by remote commands. Refer to "Auxiliary Amplifier Use" in Chapter 4 for details.
③ 5725A Amplifier Connector	Provides the analog and digital interface for the Fluke 5725A Amplifier. After the 5725A is connected to the 5725A AMPLIFIER connector, control the 5725A from the Calibrator front panel or by remote commands. Refer to "Auxiliary Amplifier Use" in Chapter 4 for details.
④ VARIABLE PHASE OUT BNC Connector	Provides access to a variable-phase nominal 2.5 V rms sine-wave signal, intended for a 3 kΩ load. The phase of this signal can be adjusted with the arrow keys and rotary knob (or by remote commands) to lead or lag the main Calibrator output signal by up to 180 degrees. The connector shell is not connected directly to chassis ground. It is connected internally to the OUTPUT LO binding post. The maximum allowable potential between the connector shell and chassis ground is 20 V peak. Refer to "Variable Phase Output" in Chapter 4 for details.

Table 3-2. Rear-Panel Features (cont.)

Item	Description
⑤ PHASE LOCK IN BNC Connector	Provides the input for an external signal onto which the Calibrator can be phase locked. (1 V rms to 10 V rms, 10 k Ω input impedance.) The connector shell is not connected directly to chassis ground. It is connected internally to the OUTPUT LO binding post. The maximum allowable potential between the connector shell and chassis ground is 20 V peak. Refer to "Phase Locking to an External Signal," in Chapter 4 for details.
⑥ AC PWR INPUT Connector	A grounded male three-prong connector that accepts the mains power cord.
⑦ Master ON/OFF Switch	This switch must be in the ON (I) position before the soft power button on the front panel will function.
⑧ F1 Fuse Holder	Line power fuse. Refer to "Fuse Replacement" in Chapter 7 for fuse rating information and the fuse replacement procedure.
⑨ Chassis Ground Binding Post	A binding post that is internally grounded to the chassis. If the Calibrator is the location of the ground reference point in a system, this binding post can be used for connecting other instruments to earth ground. (The chassis is normally connected to earth ground through the three-conductor line cord instead of through the earth ground binding post.) Refer to "Connect the Calibrator to the UUT" in Chapter 4 for details.
⑩ Rear USB Port	USB port for remote control of the Calibrator. Chapter 5 describes how to connect to the USB interface. Refer Chapter 6 for remote programming instructions.
⑪ RS 232 Connector	A male (DTE) serial port connector for remote control of the Calibrator. Chapter 5 describes proper cabling and how to set up the Serial interface and connect to it. Refer to Chapter 6 for remote programming instructions.
⑫ Ethernet Connector	100 Base/T Ethernet connector for remote control of the Calibrator. Chapter 5 describes proper cabling, how to set up the interface, and how to transmit data from the Calibrator. Chapter 5 also describes how to use the Ethernet interface for remote control.
⑬ IEEE-488 Connector	A standard interface connector for operating the Calibrator in remote control as a Talker or Listener on the IEEE-488 Bus. Refer to Chapter 5 for bus connection. Refer to Chapter 6 for remote programming instructions.

Chapter 4



Front-Panel Operation

Introduction

This chapter provides instructions to operate the 5730A Calibrator from the front panel and how to set up the Calibrator. Remote interface setups are explained in Chapter 5. Descriptions and instructions to program offsets, scale factors, and linearity checks are also provided.

Before the procedures in this chapter are started, become familiar with the front-panel controls, displays, and terminals that are identified and described in Chapter 3. Once familiar with the front panel, be sure to warm up the Calibrator in accordance with the instructions in the “Warmup” section. Also run the dc zeros process as explained in the “Run DC Zeros” section of Chapter 7. For information on remote commands used to operate the Calibrator, refer to Chapter 6.

Warning

The Product is capable of supplying lethal voltages. Do not make connections to the output terminals when any voltage is present. Placing the Product in standby may not be enough to prevent shock hazard, since the  key could be pushed accidentally. Push  and verify that standby is illuminated before making connections to the output terminals.

Turn on the Calibrator

Warning

To avoid electric shock, make sure the Product is safely grounded as described in Chapter 2.

Make sure the rear power switch is on and then push  to turn on the 5730A Calibrator. When the Calibrator is turned on, it takes approximately 50 seconds to complete its power-up process.

After the power-up process, the display shows the normal operation screen:

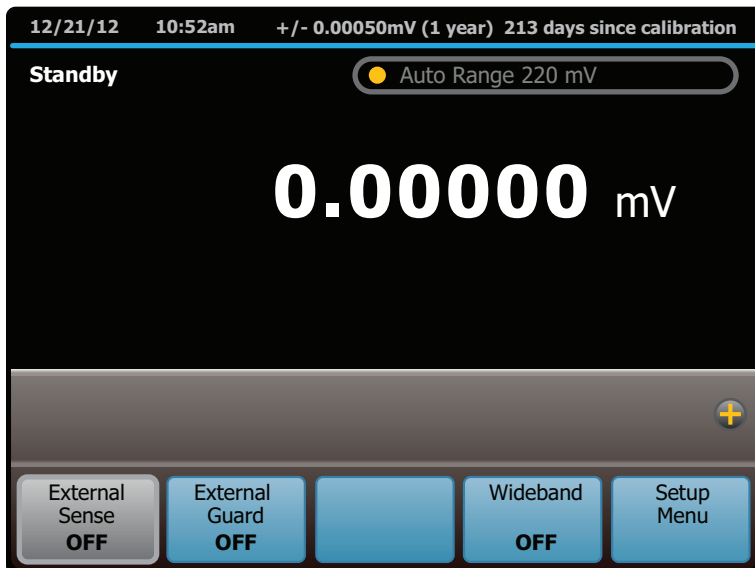

hhp102.eps

The Calibrator is in standby mode with the internal sensing and internal guard configured. The Calibrator can now accept entries from the front panel.

Warmup

Make sure the 5730A Calibrator is warmed up before use. The environmentally-controlled components inside must be stable to meet or exceed the specifications in Chapter 1. Sufficient warmup times are:

- If the Calibrator has been powered off for 1 hour or more, allow at least 30 minutes of warmup time.
- If the Calibrator has been powered off for a length of time less than 1 hour, allow it to warm up for at least twice the length of time it was turned off. For example, if it has been powered off for 10 minutes, allow at least 20 minutes of warmup time.

Product Use

Touchscreen navigation is used to move throughout the 5730A Calibrator user interface (UI) and menus.

Reset the Calibrator

At any time during front-panel operation, return the Calibrator to the power-up state with **Reset**. When **Reset** is pushed, it:

- Returns the Calibrator to the power-up state: 0 mV dc, standby, internal guard, and internal sense.
- Clears the stored values for limits, offset, scale, and error mode reference.
- Secures the Calibrator if the passcode had been entered.

Operate and Standby Modes

When the OPERATE light above the output terminals is illuminated, the output value and function shown on the display are active at the selected terminals. “Operate” also shows on the display.

When the STANDBY light above the output terminals is lit, all 5730A Calibrator binding posts except GROUND are open-circuited. “Standby” also appears on the display in this case.

Visual Connection Management output terminals illuminate in green to indicate which terminals are active and provide guidance to ensure the proper connection of cables for each function.



Push **OPERATE** to put the Calibrator into the OPERATE state. Push **STANDBY** to put the Calibrator in the STANDBY state.

If any of the subsequent events occur during operation, the Calibrator automatically switches to standby mode:

- The **Reset** key is pushed.
- A voltage ≥ 22 V is selected when the previous output voltage was < 22 V.
- The output location is changed, for example by selecting an amplifier. The exception is when the 5725A is selected for ac voltage or current, provided the Calibrator current output location is set to “5725A.”
- The output function is changed from one function to another.

Connect the Calibrator to a UUT

Warning

The Product can supply lethal voltages. Do not make connections to the output terminals when any voltage is present. Placing the Product in standby may not be enough to prevent shock hazard, since  could be pushed accidentally. Push  and make sure that standby is illuminated before making connections to the output terminals.

The binding posts labeled OUTPUT HI, OUTPUT LO, and AUX CURRENT OUTPUT deliver voltage, fixed resistance, and current to the UUT (Unit Under Test). The Type “N” connector on the front panel labeled WIDEBAND delivers the output signal from the optional 5730A/03 or 5730A/05 Wideband AC Module.

Depending on the output function, output amplitude, and input configuration of the UUT or meter, connection to the SENSE binding posts, the GUARD binding post, and the GROUND binding post may also be necessary or recommended. The text in this chapter explains how and when to use these binding posts.

Recommended Cable and Connector Types

Cables can be connected to the binding posts with banana jacks, terminal lugs, or stripped insulated wire. To avoid errors induced by thermal voltages (thermal emfs), use connectors and conductors made of copper or materials that generate small thermal emfs when joined to copper. Avoid the use of nickel-plated connectors. Optimum results can be obtained with the 5730A-7003 Low Thermal EMF Test Leads.

Cable requirements depend on the output function, amplitude, and frequency. Table 4-1 gives specific cable recommendations for all applications.

⚠ Caution

To ensure the Product is not damaged, use only cables with correct voltage ratings.

Table 4-1. Auxiliary Amplifier Data

Output Function	Cable Recommendations
DC voltage AC voltage ≤ 10 kHz AC current ≤ 2 A, ≤ 10 kHz DC current ≤ 2 A Resistance	Low Thermal EMF Test Leads ^[1] 5730A-7002 (banana plugs) or 5730A-7003 (spade lugs) (If external sensing is necessary, use a twisted shielded pair.)
AC voltage > 10 kHz	SENSE/GUARD: Triaxial cable or Twinax (e.g., Alpha 2829/2), OUTPUT: Coaxial Or: SENSE: Coaxial, OUTPUT: Coaxial GUARD Lead: Separate wire
AC current with guard	Triaxial cable
Wideband AC	3-foot (1 m) 50 Ω coaxial cable with type "N" male connectors supplied with the option. A 50 Ω feedthrough terminator is also supplied for connecting to meters with an impedance $> 50 \Omega$.
Voltage-boosted output, 5725A	Low Thermal EMF Test Leads [Note 1] 5730A-7002 (banana plugs) or 5730A-7003 (spade lugs) (Output is at the Calibrator front panel.)
Current-boosted output, 5725A	16-gauge or heavier twisted pair insulated wire, as short as possible to minimize resistance and inductance. (Output is at the amplifier terminals.)
Current-boosted output, 52120A	Refer to the 52120A manual for cable requirements.
[1] Spade lugs provide a slightly better thermal EMF performance. However, some UUTs have recessed banana connectors that cannot accommodate spade lugs.	

When to Use External Sensing

External sensing is normally necessary only when calibrating a device that draws enough current to produce a significant voltage drop in the cables. An example of such a case is with the use of the Calibrator as an external dc voltage reference for an ac/dc transfer standard. In this example, the Calibrator is sourcing 1 V dc into a Fluke 540B AC/DC Transfer Standard. The 180 Ω input impedance results in a current flow of approximately 5 mA. The Calibrator 90-day uncertainty at 1 V is specified to be $\pm(6 \text{ ppm} + 1.2 \text{ } \mu\text{V})$ or $\pm 7.2 \text{ } \mu\text{V}$. Cumulative lead and contact resistances of as little as 2 m Ω would cause a voltage drop greater than the total uncertainty of the Calibrator. External sensing eliminates this error.

The normal power-up state of the Calibrator is external sensing off, with an internal connection between the SENSE and OUTPUT automatically made. This is the state when the **External Sense** selection says OFF.

When to Use the External Voltage Guard

The voltage guard protects the analog circuitry by placing an electrical shield between the primary and secondary of the ac line power transformer. An optical cable transmits control information from the 5730A Calibrator microprocessor to analog circuits. The voltage guard provides a low-impedance path for common-mode noise and ground loop currents.

The voltage guard is usually internally connected to the OUTPUT LO terminal. This is the normal power-up state of the Calibrator, and the connection is automatically made when the external guard is not selected. This is the state when the **External Guard** selection says OFF.

If calibrating a UUT with a grounded low or common input terminal, an external connection to the V GUARD is necessary. The Calibrator voltage guard must be grounded at the UUT.

Note

To prevent ground loops, there must be only one ground connection in the system, so all ground connections should be made at the UUT. To maintain one ground point, make sure the grounding strap between the GUARD and GROUND binding posts is disconnected. See Table 3-1, items 17 and 18.

Four-Wire Vs. Two-Wire Resistance Connections

Figure 4-4 shows four different ways to connect to a UUT for resistance calibration. Figure 4-4A shows a UUT with four-wire sensing. For such meters, always take advantage of the four-wire sensing capability and use external sensing to get the highest accuracy. Four-wire sensing is available for all resistance values except 100 M Ω .

For calibrating a meter with only a two-wire resistance mode such as a typical handheld DMM, refer to Figures 4-4B through 4-4D. For resistances of 19 k Ω or lower in two-wire mode, compensation circuitry inside the 5730A Calibrator is available to remove errors introduced by resistance in the path between the front panel terminals and the precision resistor. Depending on how the meter is connected, two-wire compensation referenced at the UUT terminals (Figure 4-4C) or at the ends of the UUT test leads (Figure 4-4D) can be used. See “Resistance Output” for information on turning on and off two-wire compensation circuitry.

Figure 4-4B shows a meter connected in a two-wire connection with the two-wire compensation circuitry turned off. For low resistances where uncompensated lead resistances are significant, use the two-wire compensation circuit and the connection in Figure 4-4C or 4-4D. Use the connection in Figure 4-4C to calibrate the meter referenced at its terminals. Use the connection in Figure 4-4D to calibrate the meter referenced at the end of its test leads.

Cable Connection Instructions

To connect the 5730A Calibrator to a UUT:

1. If the Calibrator is powered on, push **Reset**, or **0 V ENTER**. Either action sets the Calibrator to 0 mV in standby.
2. Determine the appropriate figure from Table 4-2, and refer to the preceding text and Table 4-1 to make appropriate connections to the UUT.

Table 4-2. UUT Connection Figures

5730A Output	Figure
DC Voltage (including 5725A boost)	4-1
AC voltage ≤ 10 kHz	4-1
AC voltage > 10 kHz	4-2
AC current $\leq 2A, \leq 10$ kHz	4-3
Resistance	4-4
Wideband AC voltage (option 5730A/03 or 5730A/05)	4-5
5725A amplified output (current only)	4-6

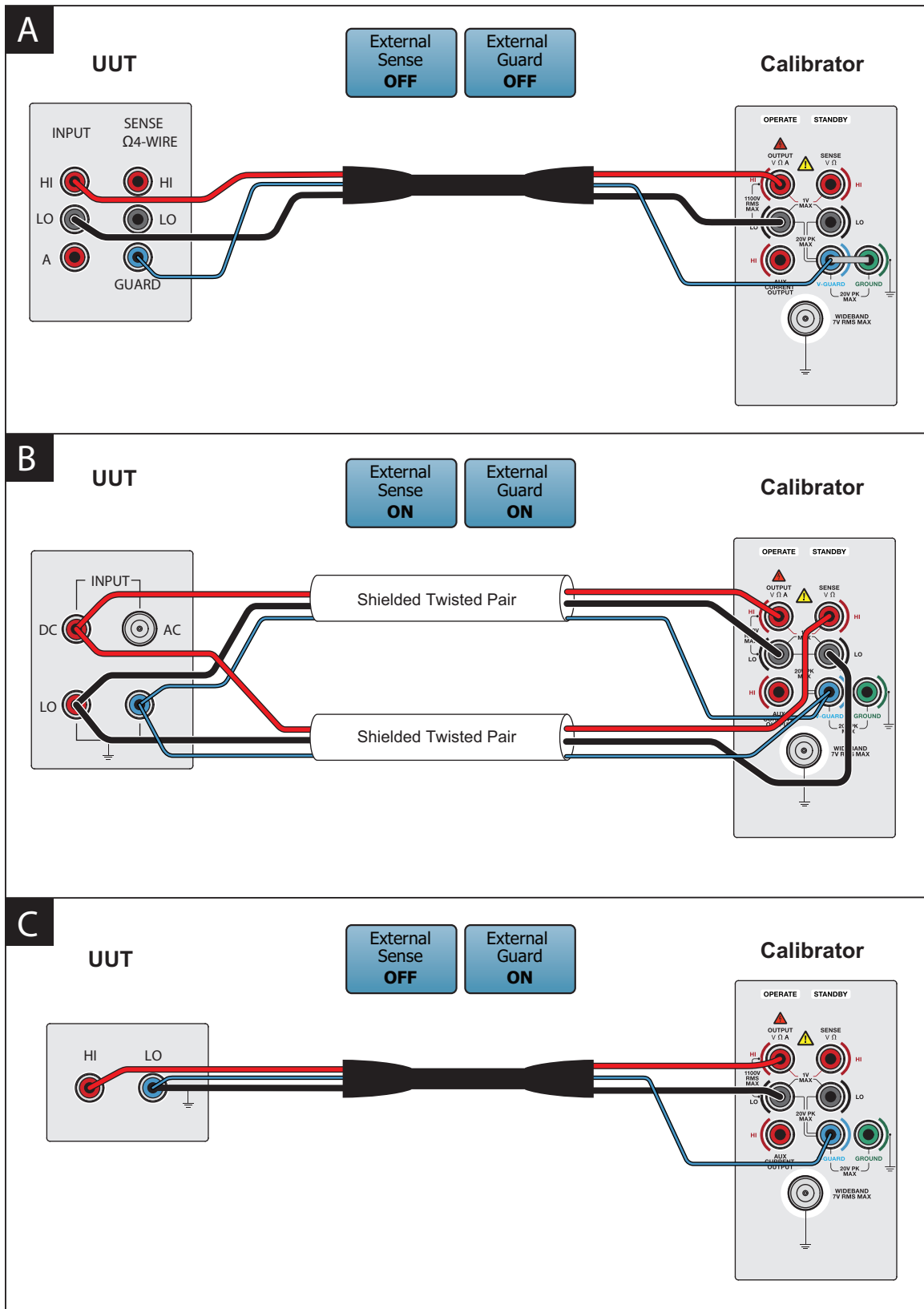

Figure 4-1. UUT Connections: DC Voltage, AC Voltage ≤ 10 kHz

hhp011.eps

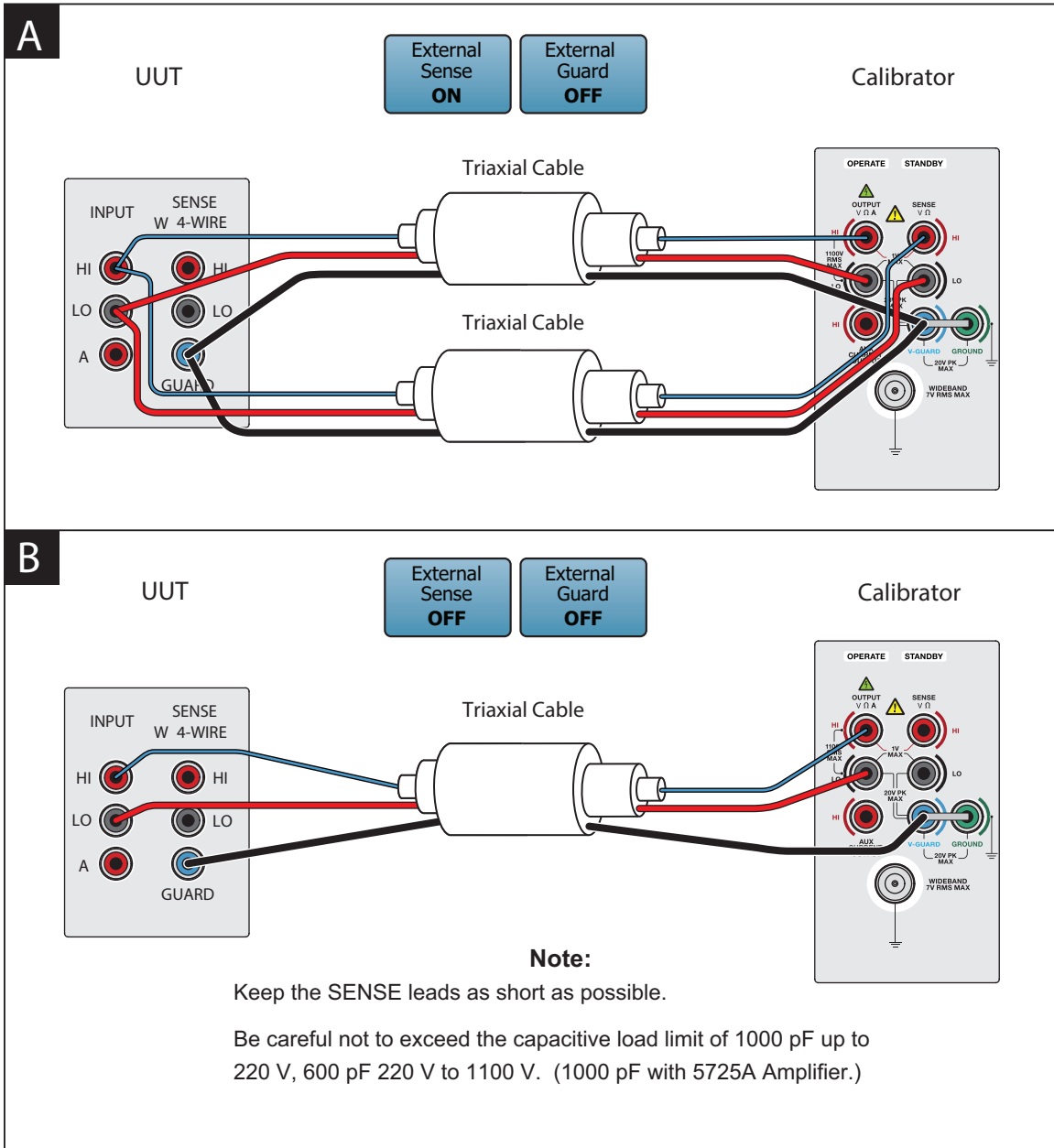

Figure 4-2. UUT Connections: AC Voltage >10 kHz

hhp012.eps

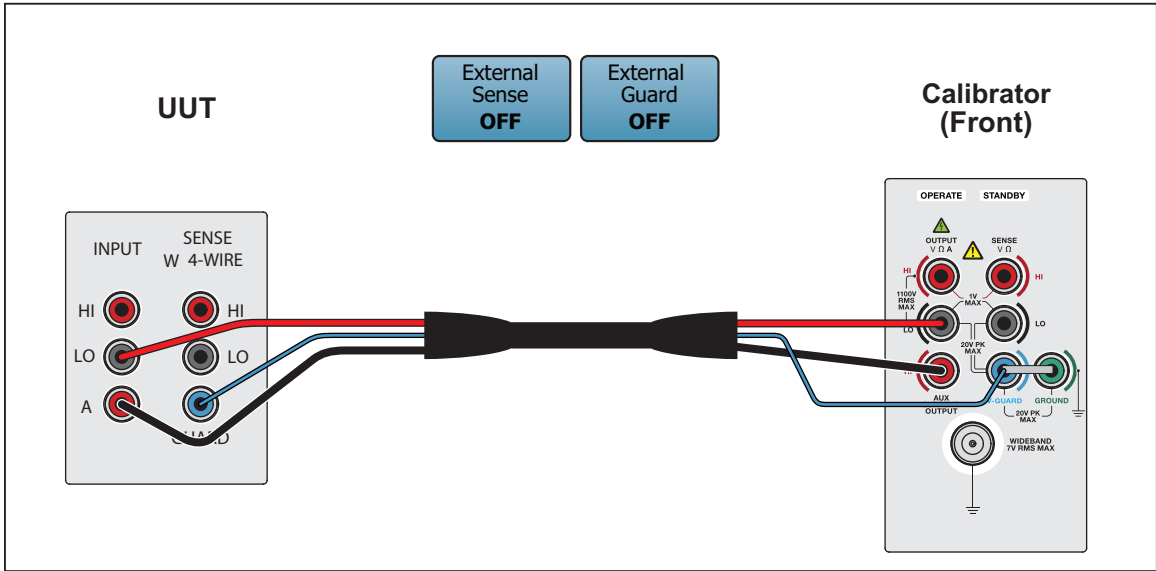

Figure 4-3. UUT Connections: AC Current $\leq 2A$

hhp013.eps

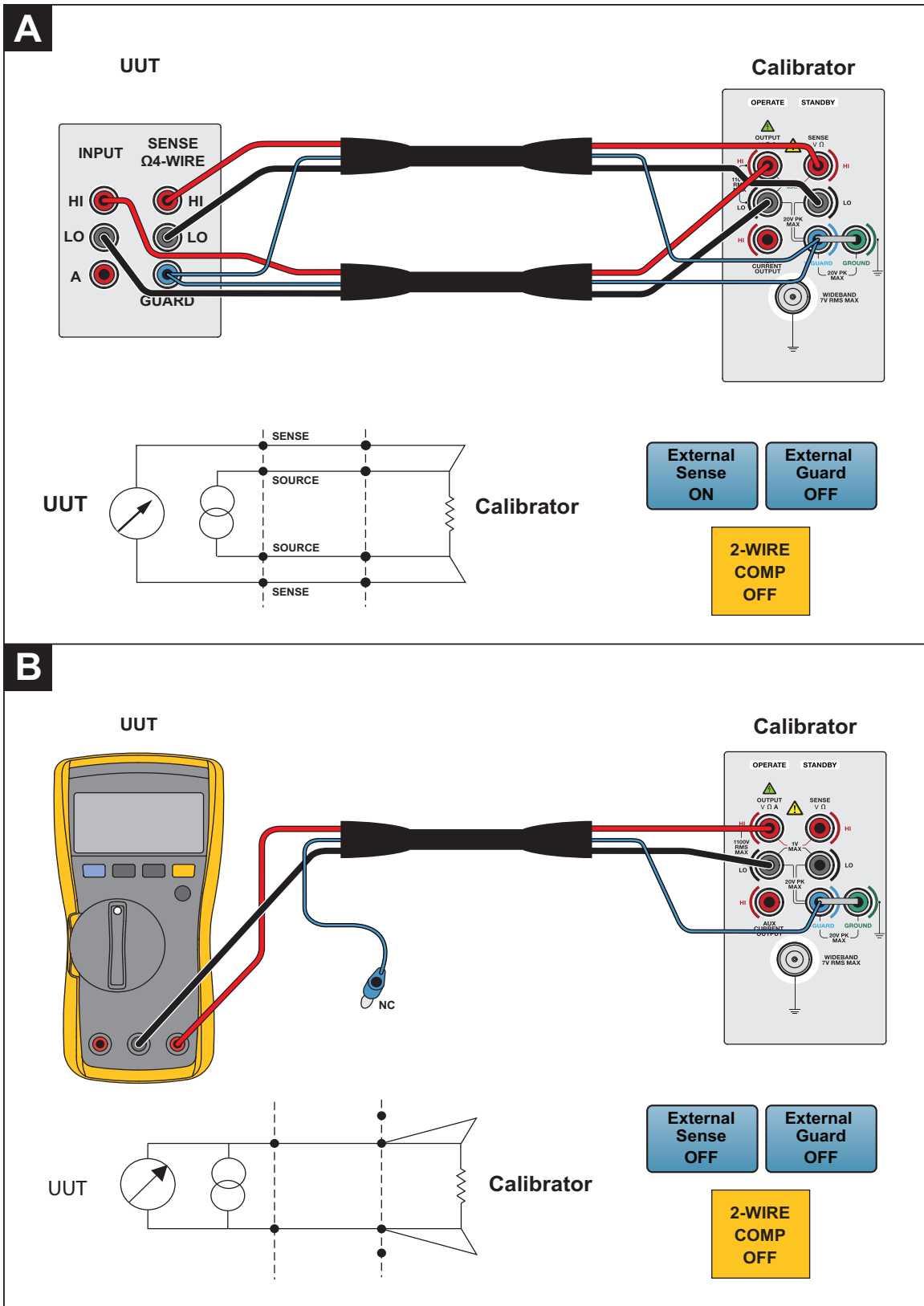

Figure 4-4. UUT Connections: Resistance

hhp014.eps

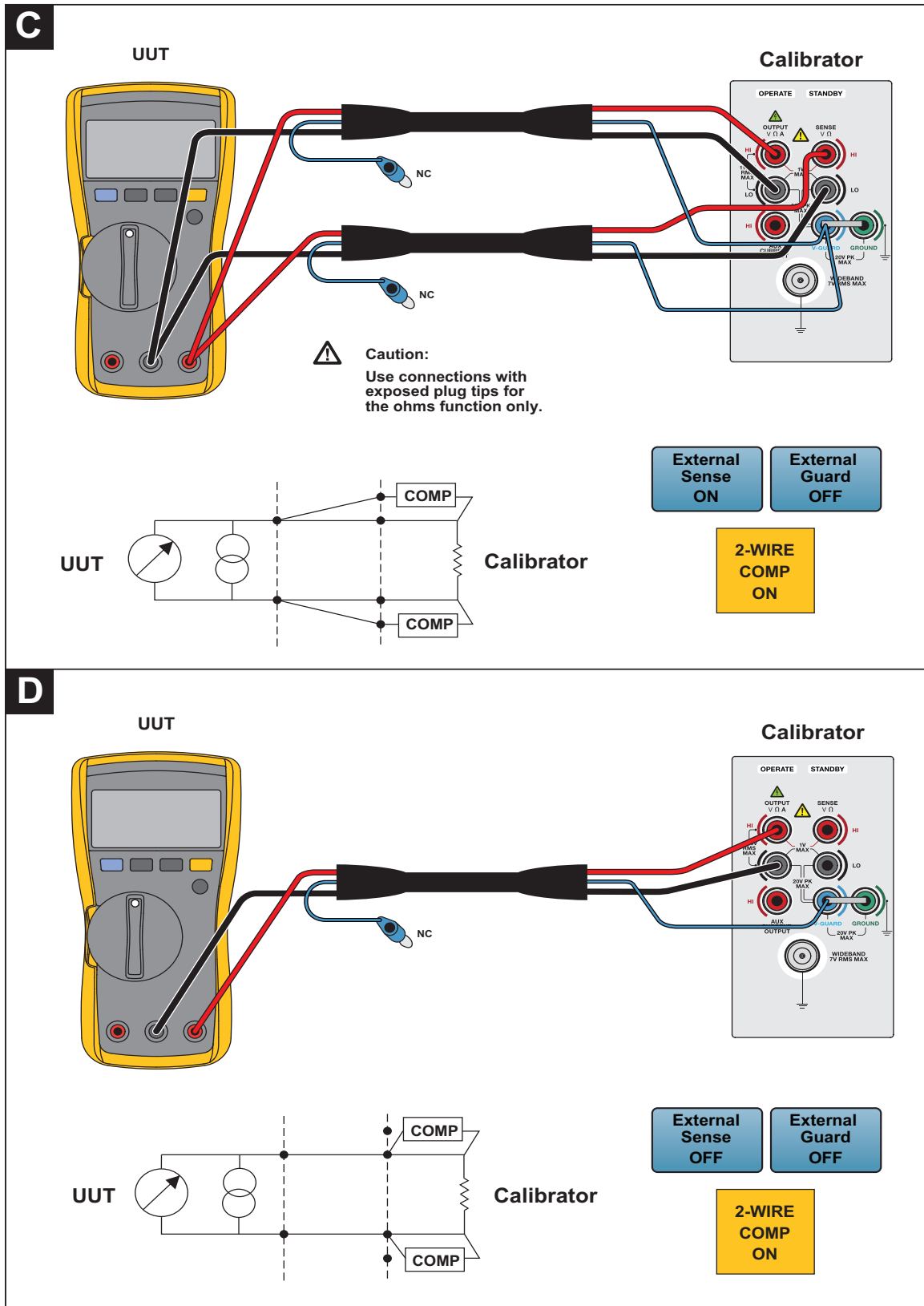

Figure 4-4. UUT Connections: Resistance (cont.)

hhp015.eps

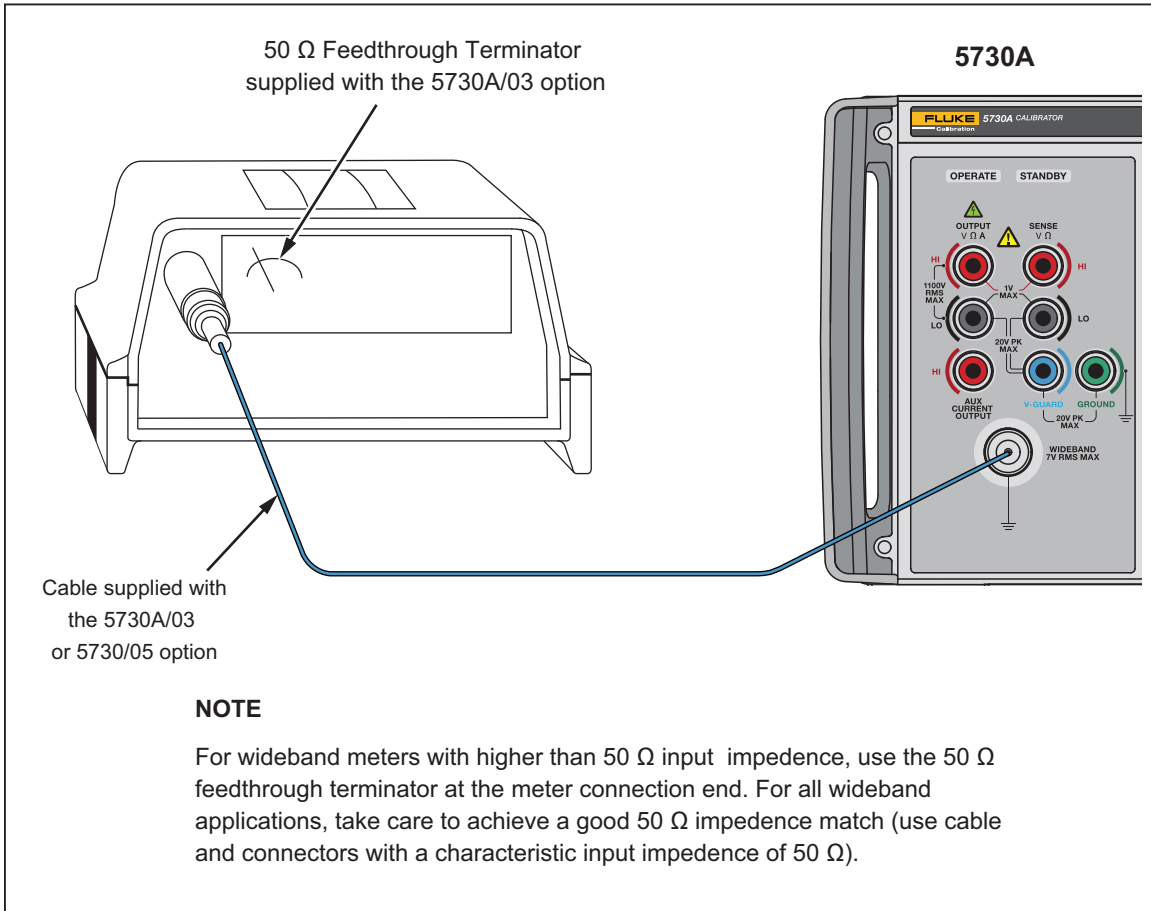

Figure 4-5. UUT Wideband AC Voltage Output (5730A/03 Option)

hhp016.eps

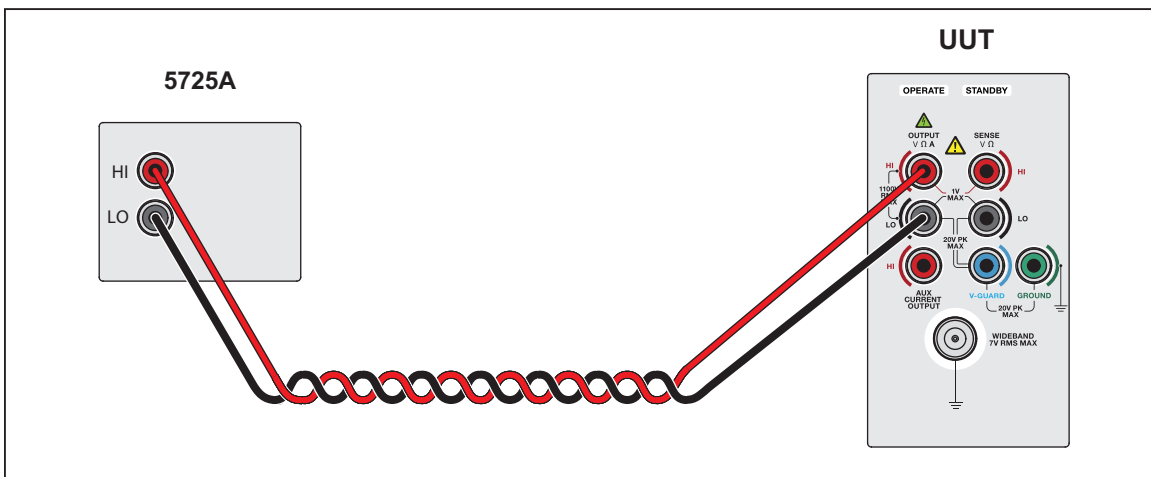

Figure 4-6. UUT Connections: 5725A Amplified Current Output

hhp017.eps

Set the Output

While in normal output mode, the display can be divided into four horizontal sections. These sections are explained in Table 4-3.

Table 4-3. Sections of the Display

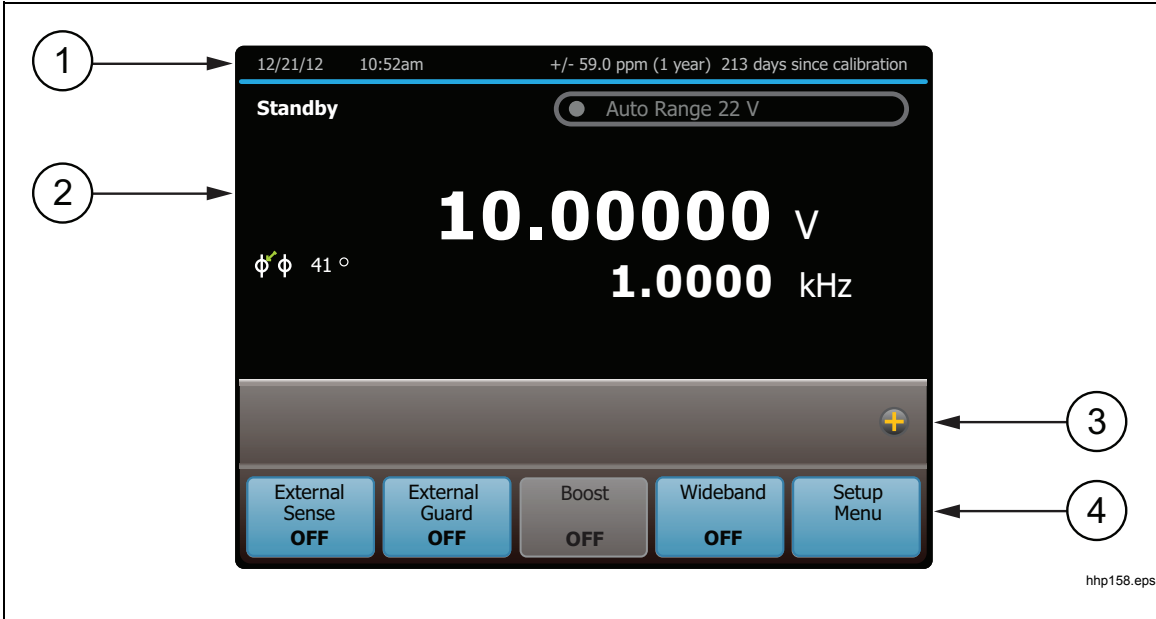

Section	Explanation
①	This section shows the date and time, the uncertainty specification of the output, and how long since the Calibrator was last calibrated.
②	<p>This section shows the output magnitude and frequency, the output range, and:</p> <ul style="list-style-type: none"> • whether the Calibrator is in STANDBY or OPERATE • a 'U' is shown when the output is unsettled and not yet within specifications • an external phase lock indicator is shown • a phase output signal indicator • various references and error amounts when error mode, scale, or offset are active • an "ADDR" indicator if the GPIB interface is active and the Calibrator is currently being addressed <p>The range indicator shows the range and if the range is locked. If it is possible to lock the range, there is a gold dot at the left of the range indicator. Pushing this dot toggles between auto-ranging and locked range.</p>
③	<p>This section has touchscreen selections. Touch the plus sign to show:</p> <ul style="list-style-type: none"> • Scale • Offset • Phase Control <p>When a value is entered, a field opens that shows the value in progress as it is entered.</p>
④	A menu of the touchscreen selections. The selections shown depend on the output function and value.

For the selections with indicators, the value shown is the value now in effect. For example, if the **External Guard** selections says OFF, then external guard is off and touching the selection will turn it on.

To set the output, push this key sequence to select an output function and amplitude:

[numeric keys] , [multiplier], [function] , **ENTER** , **OPERATE**

For example, to set the output to 10 mV dc, push:

1 **0** **m** **V** **ENTER** **OPERATE**

To set an ac output, push these additional keys:

[numeric keys] , [multiplier] , **Hz** , **ENTER**

For example, to change the present 10 mV dc to 10 mV ac at 1.8 kHz, push:

1 **.** **8** **k** **Hz** **ENTER**

To change the output back to dc, push:

0 **Hz** **ENTER** or

+/- **ENTER**

The subsequent step-by-step procedures explain how to set an output and how to use the features available for each output function:

- DC voltage
- AC voltage
- DC current
- AC current
- Resistance
- Wideband ac voltage (5730A/03 or 5730A/05 Option)
- Variable phase
- Boost operation (with an auxiliary amplifier)

DC Voltage Output

To set a dc voltage output:

1. Make sure the Calibrator is in standby (STANDBY annunciator lit). Push **STANDBY** if necessary.
2. If the UUT is not connected, connect it now as described in this chapter under “Connect the Calibrator to a UUT.”
3. Set the UUT to measure dc voltage on the necessary range.
4. Enter a voltage value with the numeric keypad.
5. To change the polarity of the entry, push **+/-**.
6. Push **μ** , **m**, or **k** if necessary.
7. Push **V**.
8. The display now shows the amplitude of the entry. If an entry error is made, push **CE** to clear the display, and then reenter the value. If the most recent digit entered is in error, push **Bksp** to clear that digit. The display shown below assumes an entry of 10 mV.

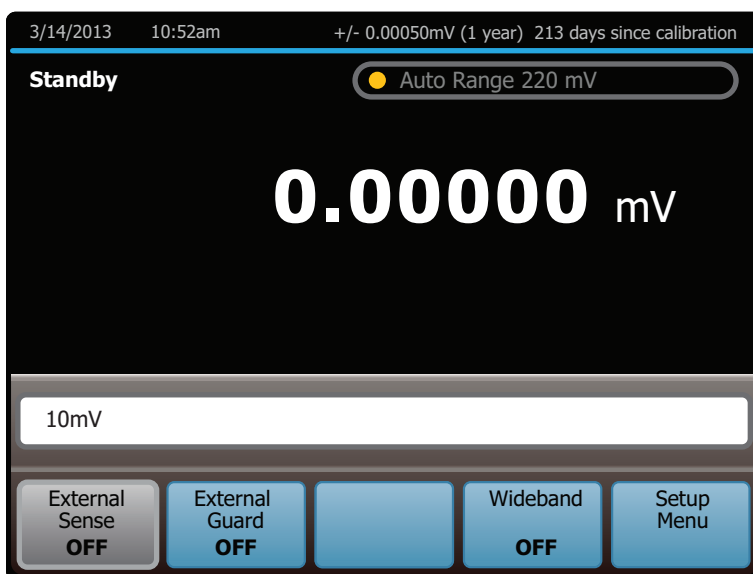

hhp113.eps

9. Push **ENTER**. The Calibrator clears the entry from the entry bar toward the bottom and shows in the larger area above. No voltage is available at the output terminals until **OPERATE** is pushed.
10. Push **OPERATE** to activate the Calibrator output. The UUT will respond to the applied voltage.

In dc voltage output mode, the selections available at the bottom are:

- External Sense
- External Guard
- Wideband
- Setup Menu

In addition, the Offset and Scale functions are available. The output range can be locked in dc volts.

AC Voltage Output

To set an ac voltage output:

1. Make sure the Calibrator is in standby (STANDBY annunciator lit). Push **STANDBY** if necessary.
2. If the UUT is not connected, connect it now as described in this chapter under “Connect the Calibrator to a UUT.”
3. Set the UUT to measure ac voltage on the appropriate range.
4. Enter the necessary voltage output in volts or dBm with the numeric keypad.

Note

In the ac voltage function, dBm means decibels relative to 1 mW, calculated for a 600 Ω load. The formula to calculate dBm is $10 \log(\text{power in mW})$. For example, if 3.0V is supplied to a 600Ω load, the dBm level is:

$$10 \log (15.0 \text{ mW}) = 11.7609 \text{ dBm.}$$

If the Calibrator is switched to Wideband AC output, but dBm is kept as the displayed units, the dBm value changes. The value changes because dBm is calculated for a 50 Ω load in the Wideband AC output function. With the use of the same voltage level as in the previous example, if the Calibrator is switched to Wideband AC output, the dBm level changes to $10 \log (180.0 \text{ mW}) = 22.5527 \text{ dBm}$.

5. To enter a negative dBm value, push **+/-**.
6. Push **μ**, **m**, or **k** if necessary.
7. Push **V** for volts, or push **dBm** for a dBm level.
8. The display now shows the amplitude of the entry. If an entry error is made, push **CE** to clear the display, then reenter the value. If the most recent digit entered is in error, push **Bksp** to clear that digit. The display shown below assumes an entry of 19 V:

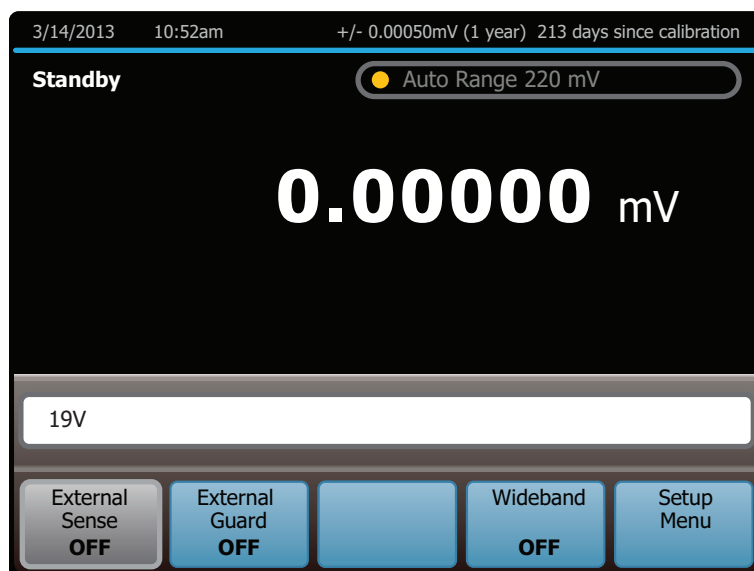

hhp114.eps

9. Enter a frequency with the numeric keypad followed by **k** or **m** if necessary. The display now shows the amplitude and frequency of the entry. If an entry error is made, use **Bksp** to clear the most recently entered digit, or push **CE** to clear the display. Reenter the value. The display shown below assumes an entry of 2.8 kHz.

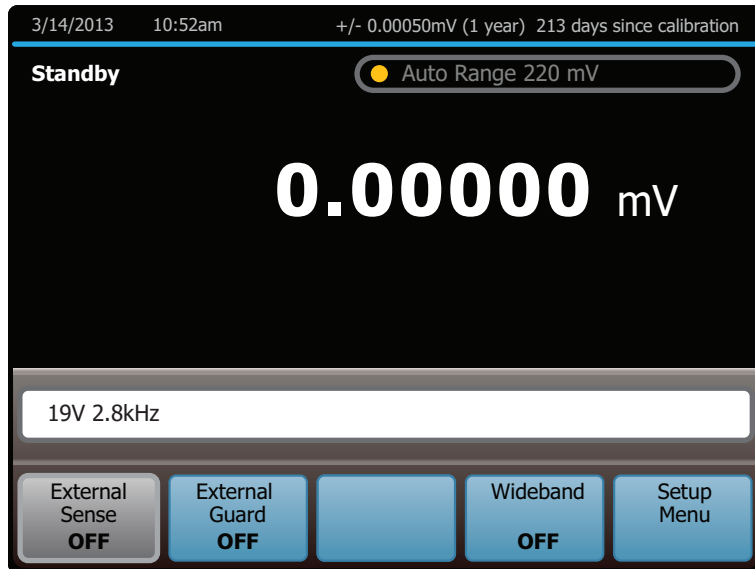

hhp115.eps

10. Push **ENTER**. The Calibrator clears the entry from the entry bar toward the bottom and shows in the larger area above. No voltage is available at the output terminals until **OPERATE** is pushed.
11. Push **OPERATE** to activate the Calibrator output. The UUT will now respond to the applied voltage.

In AC voltage output, the selections available at the bottom are:

- External Sense
- External Guard
- Boost
- Wideband
- Setup Menu

In addition, the Phase Control and Scale functions are available. The output range is always automatically chosen and cannot be locked in ac volts.

Note

The Calibrator stays in the ac function after a non-zero frequency is entered. To change back to dc, enter a frequency of 0 Hz or a signed voltage.

DC Current Output

To set a dc current output:

1. Make sure the Calibrator is in standby (STANDBY annunciator lit). Push **STANDBY** if necessary.
2. If the UUT is not connected, connect it now as described earlier in this chapter under “Connect the Calibrator to a UUT.”
3. Set the UUT to measure dc current in the appropriate range.
4. Enter a current value with the numeric keypad.
5. To change the polarity of the entry, push **+/-**.
6. Push **μ** or **m** if necessary.
7. Push **A**.
8. The display now shows the amplitude of the entry. If an entry error is made, push **CE** to clear the display, then reenter the value. If the most recent digit entered is in error, push **Bksp** to clear that digit. The illustration of the display below assumes an entry of 30 mA:

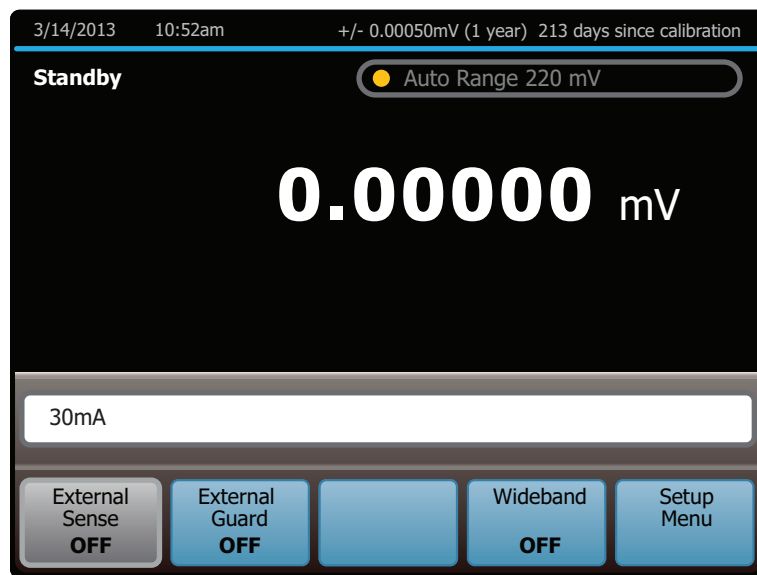

hhp117.eps

9. Push **ENTER**. The Calibrator clears the entry from the entry bar toward the bottom and shows in the larger area above. No current is available at the output terminals until **OPERATE** is pushed.
10. Push **OPERATE** to activate the Calibrator output. The UUT will now respond to the applied current.

In dc current output, the selections available at the bottom are:

- Current Output
- External Guard
- Boost
- Wideband
- Setup Menu

In addition, the Offset and Scale functions are available. The output range can be locked in dc current.

Current Output selects one of three locations for non-boosted (current sourced by the Calibrator, for example) current output:

- OUTPUT binding post (NORMAL, which is the OUTPUT HI binding post, also the default setting)
- AUX, which is the AUX CURRENT OUTPUT binding post
- 5725A which is the 5725A Amplifier binding posts. (The 5725A must be turned on, but not necessarily activated.)

Non-boosted current from the Calibrator is not available at the 52120A amplifier binding posts.

AC Current Output

To set an ac current output:

1. Make sure the Calibrator is in standby (STANDBY annunciator lit). Push **STANDBY** if necessary.
2. If the UUT is not connected, connect it now as described earlier in this chapter under “Connect the Calibrator to a UUT.”
3. Set the UUT to measure ac current on the appropriate range.
4. Enter a current magnitude with the numeric keypad.
5. Push **μ** or **m** if necessary.
6. Push **A**.
7. The display now shows the amplitude of the entry. If an entry error is made, push **CE** to clear the display, then reenter the value. If the most recent digit entered is in error, push **Bksp** to clear that digit. The illustration of the display below assumes an entry of 125 mA:

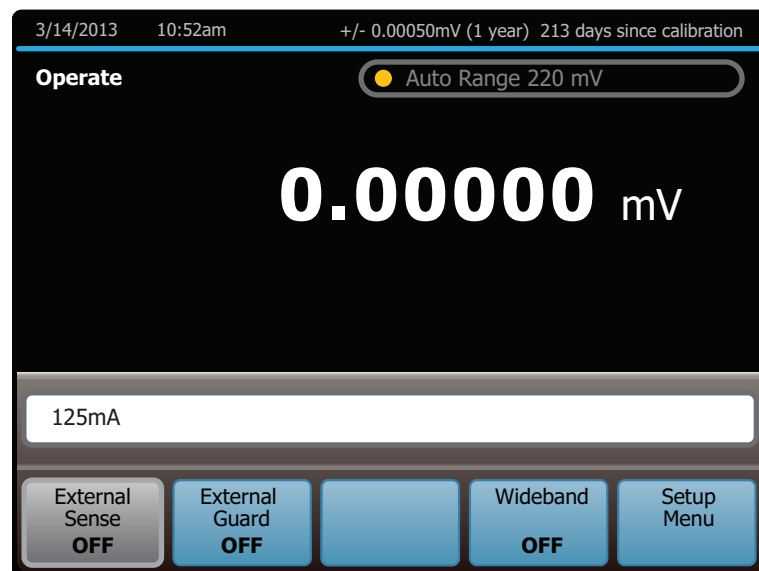

hhp119.eps

8. Enter a frequency with the numeric keypad (followed by **k** if necessary). The display now shows the amplitude and frequency of the entry. If an entry error is made, push **CE** to clear the display, then reenter the value. If the most recent digit entered is in error, push **Bksp** to clear that digit. The display below assumes an entry of 2.5 kHz:

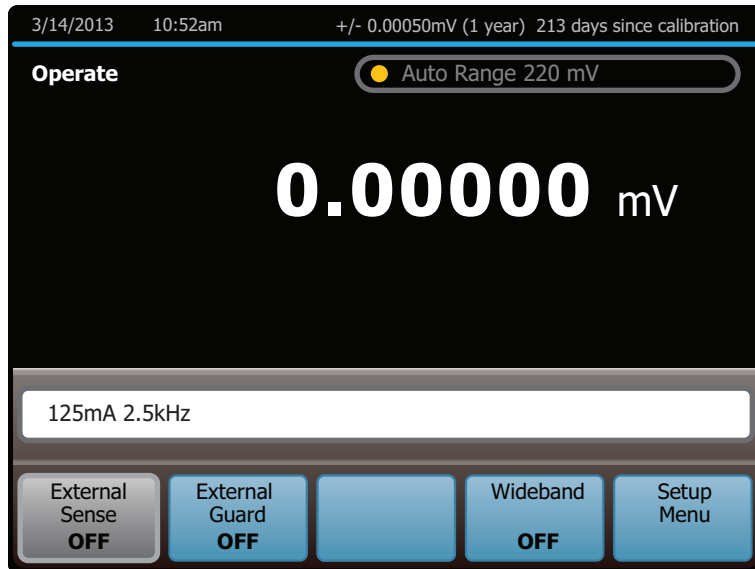

hhp120.eps

9. Push **ENTER**. The Calibrator clears the entry from the entry bar near the bottom and shows in the larger area above. No current is available at the output terminals until **OPERATE** is pushed.
10. Push **OPERATE** to activate the Calibrator output. The UUT will now respond to the applied current.

In AC current output, the selections available at the bottom are:

- Current Output
- External Guard
- Boost
- Wideband
- Setup Menu

In addition, the Phase Control and Scale functions are available. The output range is always automatically chosen and cannot be locked in ac current.

Note

*The Calibrator stays in the ac function after a non-zero frequency is entered. To change back to dc, enter a frequency of 0 Hz or push **+/-** and then **ENTER**.*

The **Current Output** item selects one of three locations for non-boosted (current sourced by the Calibrator, for example) current output:

- OUTPUT binding post (NORMAL, which is the OUTPUT HI binding post, also the default setting)
- AUX, which is the AUX CURRENT OUTPUT binding post
- Boost which is the 5725A Amplifier binding posts. (The 5725A must be turned on, but not necessarily activated.)

Non-boosted current from the Calibrator is not available at the 52120A amplifier binding posts.

Resistance Output

In the resistance function, the Calibrator supplies a choice of 18 standard resistance values or a short at the output terminals. The values available are:

0 Ω	190 Ω	190 kΩ
1.0 Ω	1.0 kΩ	1.0 MΩ
1.9 Ω	1.9 kΩ	1.9 MΩ
10 Ω	10 kΩ	10 MΩ
19 Ω	19 kΩ	19 MΩ
100 Ω	100 kΩ	100 MΩ

To select a resistance output:

1. Make sure the Calibrator is in standby (STANDBY annunciator lit). Push **STANDBY** if necessary.
2. If the UUT is not connected, connect it now as described previously in this chapter under “Connect the Calibrator to a UUT.”
3. Set the UUT to read resistance on the appropriate range.
4. Push the numeric keys of the nominal resistance, or touch “Ω Value Table” to show a list of the selectable resistance values as shown below.

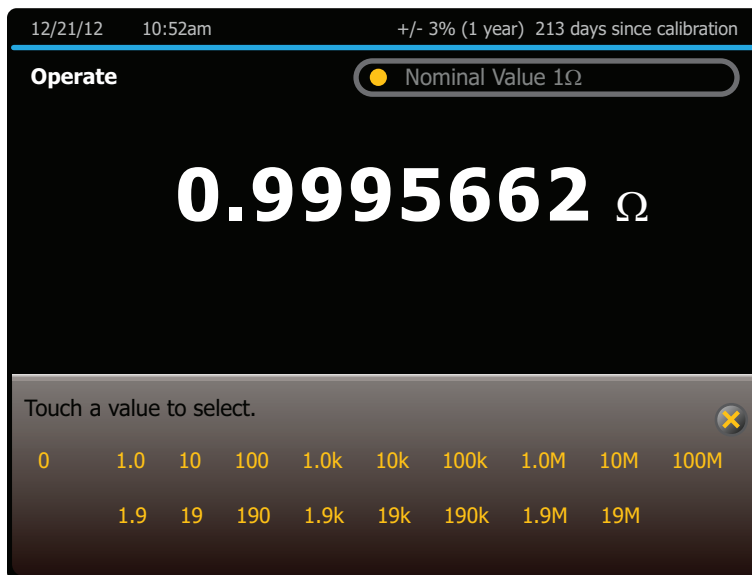

hhp225.eps

If the “ Ω Value Table” selection is used, touch the desired resistance value and to select it. To exit the menu, touch the “x” on the top right of the table.

5. Push **k** or **m** if necessary.
6. Push **Ω** .
7. Push **ENTER**. If a resistance value that is unavailable (as in the subsequent example of 490 Ω) is entered, the display prompts to try again.

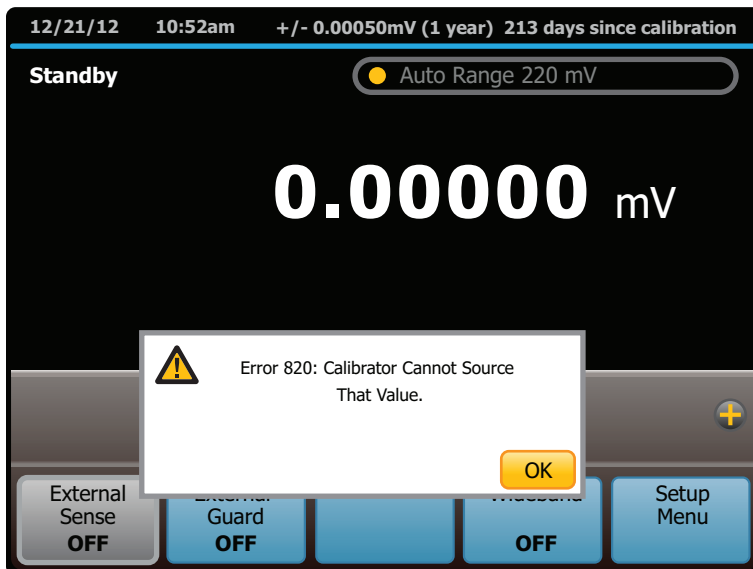

hhp123.eps

8. After a valid resistance is specified and **ENTER** is pushed, the Calibrator clears the entry from the entry bar near the bottom and shows in the larger area above.
9. Push **OPERATE**. This resistance is now available at the output terminals.

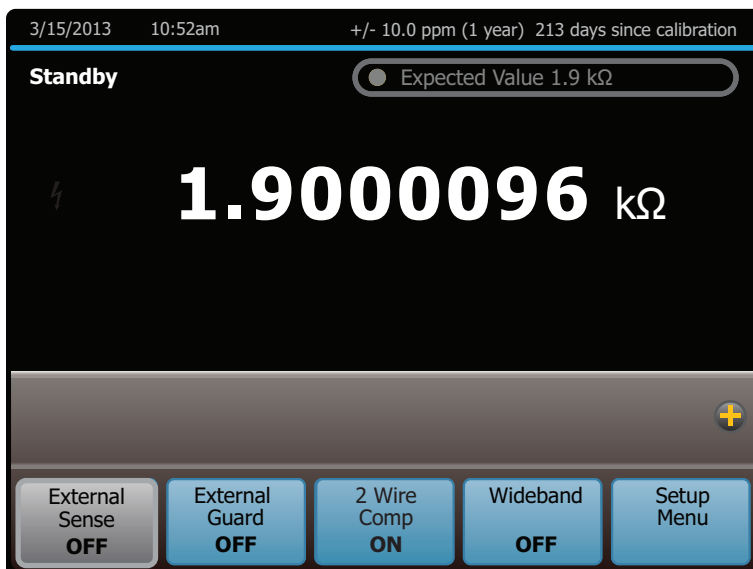

hhp124.eps

In resistance output, the selections available at the bottom are:

- External Sense
- External Guard
- 2-wire Compensation
- Wideband
- Setup Menu

In the resistance function, two features are available to enhance accuracy: four-wire sensing and two-wire compensation. Two-wire compensation works with either a two-wire connection or a four-wire connection to a two-wire ohmmeter. A full explanation follows:

Four-wire connection is available for all resistance values except 100 M Ω . To activate four-wire resistance, turn External Sense on. (Figure 4-4A shows the four-wire connection.)

For calibrating a meter with a two-wire resistance mode such as a typical handheld digital multimeter (DMM), refer to Figures 4-4B through 4-4D. For resistances of 19 k Ω or lower in two-wire mode, compensation circuitry inside the Calibrator is available to remove errors introduced by resistance in the path between the front panel terminals and the precision resistor. The **2-wire Compensation** item is shown at the bottom of the display when resistances of 19 k Ω or lower are selected. This selection lets the compensation circuitry be disabled and enabled.

Depending on how the meter is connected, two-wire compensation referenced at the UUT terminals (Figure 4-4C) or at the Calibrator terminals (Figure 4-4D) can be used.

Figure 4-4B shows a meter connected in a two-wire connection with the two-wire compensation circuitry turned off. Use this configuration only if lead resistances are insignificant. For a two-wire connection, turn External Sense off.

For resistances where uncompensated lead resistances are significant, use the two-wire compensation circuit and the connection in Figure 4-4C or 4-4D. Use the connection in Figure 4-4C to calibrate the meter referenced at its terminals. Use the connection in Figure 4-4D to calibrate the meter referenced at the ends of its test leads.

Wideband AC Voltage Output (Option 5730A/03 or 5730A/05)

To set an output from the Wideband AC Module (Option 5730A/03 or 5730A/05), proceed from **Reset** or the power-up state as follows:

1. Make sure the Calibrator is in standby (STANDBY annunciator lit). Push **STANDBY** if necessary.
2. If the UUT is not connected, connect it now as described previously in this chapter under “Connect the Calibrator to a UUT.”
3. Set the UUT to read ac voltage on the appropriate range.
4. Touch Wideband.
5. With the numeric keypad, enter the necessary output amplitude, expressed as voltage or a dBm level.

Note

In the Wideband AC function, dBm means decibels relative to 1 mW, calculated for a 50 Ω load. The formula to calculate dBm is $10 \log(\text{power in mW})$. For example, if 3.0 V is supplied to a 50 Ω load, the dBm level is:

$$10 \log (180.0 \text{ mW}) = 22.5527 \text{ dBm}$$

If the Calibrator is switched to standard ac output, but dBm is kept as the displayed units, the dBm value changes. The value changes because dBm is calculated for a 600 Ω load in the standard ac output function. With the same voltage level as in the previous example, if the Calibrator is switched to standard ac output, the dBm level changes to:

$$10 \log (15.0 \text{ mW}) = 11.7609 \text{ dBm.}$$

6. To enter a negative dBm value, push **+/-**.
7. Push **μ** or **m** if necessary.
8. Push **V** for volts or **dBm** for volts expressed as dBm.

- The display now shows the amplitude of the entry. If an entry error is made, push **CE** to clear the display, then reenter the value. If the most recent digit entered is in error, push **Bksp** to clear that digit. The illustration of the display below assumes an entry of 20 dBm:

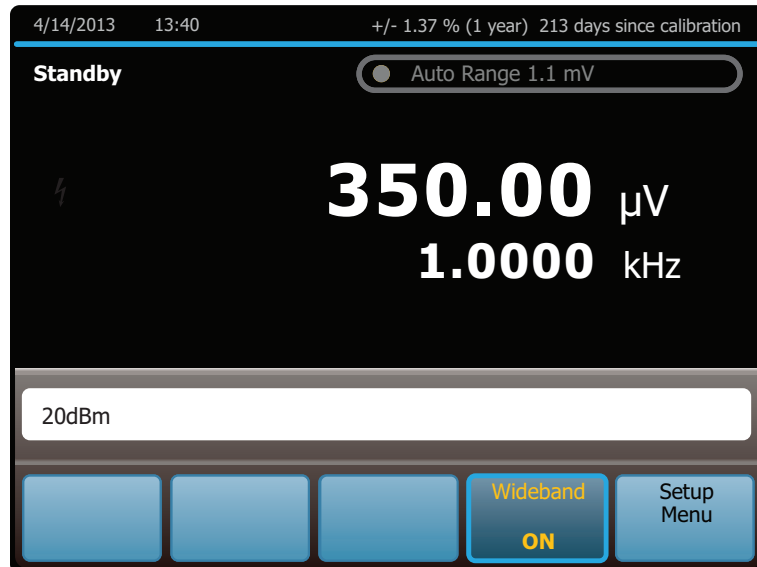

hhp125.eps

- With the numeric keypad, enter a frequency, followed by **k** or **M** if necessary. The display now shows the amplitude and frequency of the entry. If an entry error is made, push **CE** to clear the display, then reenter the value. If the most recent digit entered is in error, push **Bksp** to clear that digit. The display shown below assumes an entry of 21 MHz:



hhp126.eps

11. Push **ENTER**. The Calibrator clears the entry from the entry bar toward the bottom and displays in the larger area above. No voltage is available at the WIDEBAND Type “N” coaxial connector until **OPERATE** is pushed.
12. Push **OPERATE** to activate the Calibrator output. The UUT will now respond to the applied voltage.

Note

*To deactivate the Wideband AC Module and switch to another output function, touch **Wideband** again. When sourcing an ac voltage or dBm level within the range of the standard ac voltage output mode, that value is selected. Otherwise, the Display reads 0 mV (dc). When using units of dBm and switching between wideband and standard ac voltage output, the amplitude changes. This change occurs because for the wideband function, decibel levels are computed for a 50 Ω load, and for the standard ac function, decibel levels are computed for a 600 Ω load.*

Variable Phase Output

A variable-phase signal of nominally 2.5 V rms is available at the rear panel BNC connector labeled VARIABLE PHASE OUT when sourcing ac volts, wideband voltage below 1.2 MHz, or ac current outputs. The phase of this signal with respect to the main output signal is continuously adjustable from -180° to $+180^\circ$ in 1° increments. The rotary knob, numeric keypad, and selections adjust the phase of this signal, after calling up the phase controls as described below. The display shows the phase of the phase output signal as a number and a cursor on a linear scale graduated in 90° steps from -180° to $+180^\circ$.

To set and adjust a phase output:

1. Set an ac voltage or current output as described under “AC Voltage Output” or “AC Current Output.”
2. Touch the + icon on the right of the display above the bottom row of selections to expose the phase controls.
3. Touch **Phase Control**. This exposes the phase entry window.
4. To turn phase shift output on, touch the checkbox.

- The phase can now be changed by entering a value with the numeric keypad, turning the knob, or touching a point on the phase scale.

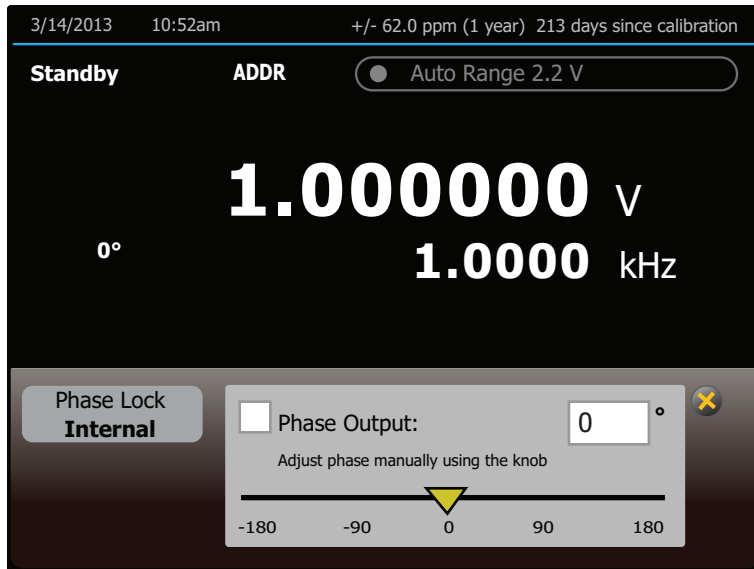

hhp127.eps

- To turn phase shift off, touch the checkbox again. To enter a new amplitude leaving the phase shift as is, touch the **X** icon (where the + was) to collapse the phase control window before the new amplitude is entered.

Phase Locking to an External Signal

The phase-lock feature locks the Calibrator main output signal in phase with an external signal (1 V rms to 10 V rms at 10 Hz to 1.2 MHz) applied to the rear panel PHASE LOCK IN BNC connector. This feature can be used with ac volts, wideband voltage, or current outputs, and combine it with variable phase output. The phase lock control is in the window with the phase output controls. To lock onto an external signal:

- With the external signal source turned off, connect a coaxial cable between the external signal source and the rear panel PHASE LOCK IN BNC connector.

Note

When PHASE LOCK IN is used, make sure the phase lock source is floating relative to the Calibrator output. Ground loops that can occur if the two devices are not isolated can cause amplitude errors in the Calibrator output. These errors may be particularly significant in the millivolt ranges.

- Set an ac voltage or current output as described under “AC Voltage Output” or “AC Current Output”.
- Turn on the external signal source.
- Set the Calibrator frequency to within 2 % of the external source frequency.
- Touch the + icon on the right of the display above the bottom row of selections to expose the phase controls.

6. Touch **Phase Reference** to toggle between INTERNAL (the default, not locked to anything) and EXTERNAL.
7. If the Calibrator cannot lock onto the external signal for any reason, it shows the message below:

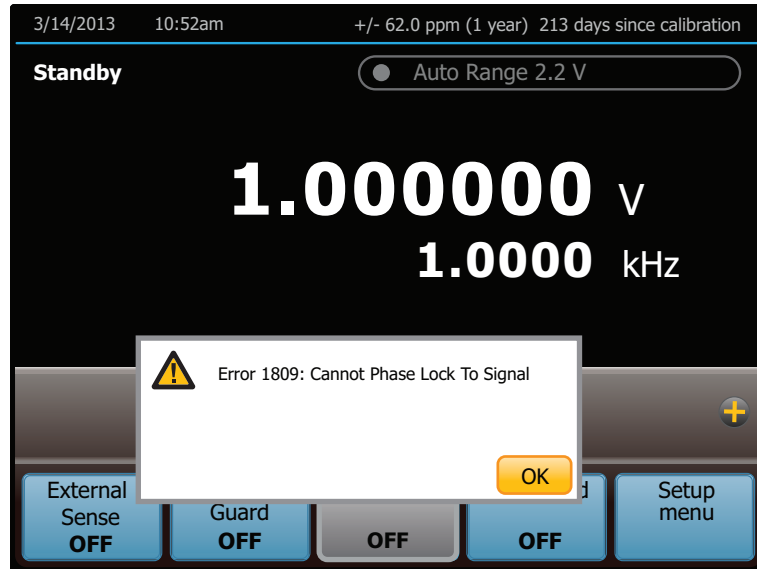

hhp129.eps

8. To reactivate the numeric keypad for controlling the output, touch **OK**. Phase locking remains active until the frequency is changed or turned off phase lock with the **Phase Reference** selection.

Auxiliary Amplifier Use

Increase the output capability of the Calibrator with an auxiliary amplifier. The Calibrator has rear-panel connectors that interface with two different amplifiers. Both amplifiers can be connected to the Calibrator simultaneously, but only one amplifier can be designated as the voltage boost and one amplifier as the current boost in the setup menu. Only one output can be active at a time. Table 1-1 shows the ranges and functions supported by the 5725A. The choice of active amplifier can be changed dynamically in a remote system, since such systems can control any front panel function.

During boost operation, operate the amplifier from the Calibrator front panel. The Calibrator computes and supplies the correct excitation signal to drive the amplifier. The Calibrator display always shows the actual output of the amplifier, not the excitation output of the Calibrator. In general, for the 5725A, the amplifier is activated automatically by selecting an output amplitude only available in its range. For the 52120A and in some cases with the 5725A and 52120A, the **Boost** selection is used to activate and deactivate the selected amplifier. Refer to the subsequent text for specific operation instructions for each type of amplifier.

5725A Amplifier Output

⚠⚠ Warning

Boosted voltage operation produces high voltage at higher current levels than normally available from the Product. During boosted voltage operation, the potential risk of injury or fatal accident is greater than during normal operation.

Note

Refer to the 5725A Instruction Manual for setup and installation instructions.

The 5725A Amplifier boosts ac voltage and both ac and dc current. To set a boosted output from the 5725A Amplifier:

1. If not already installed, install the 5725A as described in the *5725A Instruction Manual*.
2. If the “Boost Amp Types” setting in the Setup Menu has been changed from the default, select the 5725A for boost operation as described at the beginning of this chapter.
3. Make sure the Calibrator and 5725A are in standby (STANDBY annunciator lit). Push **STANDBY** if necessary.
4. If the UUT is not connected, connect it now as described earlier in this chapter under “Connect the Calibrator to a UUT.” Note that for boosted current, connect to the 5725A binding posts, and for boosted voltage, connect to the Calibrator binding posts.
5. Set the UUT to read the appropriate quantity.
6. Enter the necessary output value as described under “Setting the Output.” Current entries beyond the standard range of the Calibrator automatically select the amplifier. Voltage entries in the 220 V-1100 V range automatically select the amplifier. Note that the 5725A takes over the 1100 V range of the Calibrator.
7. Boosted voltage output is available at the front panel of the Calibrator. Boosted current output is available at the front panel of the 5725A Amplifier. When the 5725A binding posts are selected, the **Current Output** selection indicates the output location. If the entry has caused a change of output location, **OPERATE** must be pushed to activate the amplifier.
8. When the range is set to “AUTO”, the amplifier is automatically disabled whenever a current level within the range of the Calibrator is set. Locking the range turns off this auto disable, so the amplifier can be used at lower current levels.

Note

*The 5725A can source a current below 2.2 A to take advantage of the amplifier higher compliance voltage of the amplifier. To do so, lock onto the 11 A range when the Calibrator is set for over 2.2 A, or set the lower current and touch **Boost** to turn on the amplifier.*

9. To deactivate the amplifier, touch **Boost** again.

52120A Transconductance Amplifier Output

The 52120A Amplifier boosts ac and dc current. A maximum of three 52120A amplifiers may be connected together to the Calibrator. When their outputs are connected in parallel, they produce two (for two 52120As) or three (for three 52120As) times the current output, providing up to 300 A of dc current and 360 A rms ac current.

To set a boosted output with the 52120A Amplifier:

1. Install the 52120A as described in the *52120A Users Manual*.
2. If the “Boost Amp Types” setting in the Setup Menu has been changed from the default, select the 52120A for current boost as described at the beginning of this chapter.
3. Make sure the Calibrator and 52120A are in standby (STANDBY annunciator lit). Push **STANDBY** if necessary.
4. If the UUT is not connected, connect it now as described earlier in this chapter under “Connect the Calibrator to a UUT.” For boosted current, connect to the 52120A binding posts.
5. Set the UUT to read the appropriate quantity.
6. Enter the necessary output value as described under “Set the Output.” Current entries beyond the standard range of the Calibrator automatically select the amplifier.
7. To deactivate the amplifier, touch **Boost** again.

Error Mode Operation

The output adjustment controls (arrow keys and the rotary knob) are used to adjust the output of the Calibrator incrementally (except in the resistance function). As this happens, the Calibrator computes and shows the difference between the adjusted output and the reference level in ±% or ±ppm (parts per million). The reference level is the original output setting before it was adjusted. When this capability is used to adjust the output until the UUT reads correctly, the displayed difference is the UUT error for that output setting. The error is shown in ±% unless it is ±20 ppm or less.

For example, if the Calibrator is set to output 10.00000 V, and the UUT reads high. To determine the error, use the output adjustment controls to adjust the Calibrator until the UUT reads 10.0000 V. If, for example, the Calibrator display now reads 9.993900, the Calibrator calculates and shows a UUT error of +0.0610 % on the display.

The Calibrator uses this formula to calculate the UUT error:

$$\text{Error} = \frac{(\text{Reference}) - (\text{Final Output})}{(\text{Reference})} \times 100 \%$$

The rotary knob is also a convenient way to change the frequency during ac voltage tests. To adjust frequency in error mode, for example, when meter flatness is tested, push **Ampl Freq**. The 10 Hz digit of the frequency line is highlighted. Push **◀** twice. When the knob is turned, the output frequency increases or decreases 1 kHz per knob click.

Error Mode Overview

This section explains how to use Error Mode in general. After the overview, a step-by-step procedure explains how to use this mode to read UUT error for each Calibrator output function.







Enter Error Mode

To start Error Mode, turn the rotary knob, push an arrow key, or push . When error mode is entered, the starting value is the reference from which errors are computed. A new reference is established when you exit and then reenter error mode.

Exit Error Mode

Table 4-4 lists the actions that cause the Calibrator to exit error mode.

Table 4-4. Keys that Exit Error Mode

Key or Selection	Action
	Returns to the previous reference value.
 	Establishes a new reference.
A new keypad entry + 	Establishes a new reference.
New Ref Selection	Establishes the present output as a new reference.
	Establishes a new reference that is equal to ten times the previous reference value.
	Establishes a new reference that is equal to one tenth of the previous reference value.
Offset Selection	Identifies the present output as a zero-scale endpoint for scaling and establishes 0.0 as the new reference.
Scale Selection	Identifies the present output as a full-scale endpoint for scaling and causes the display to show scale error.
	Returns to the power-up state.
Setup Menu Selection	Opens the Setup menu.

Note

*The **Scale** and **Offset** selections are revealed by touching the + icon on the right of the display above the bottom row of selections. The **New Ref** selection appears with the **Scale** and **Offset** selections once error mode is entered.*

Use Error Mode

When error mode is entered from any output function except resistance, the least significant digit on the Display is highlighted. Push **Ampl Freq** to enter error mode and select the frequency line for adjustment first (but only if the frequency is not zero).

When the rotary knob is turned, the highlighted digit increments or decrements. Turn the knob clockwise to make the number more positive. Turn the knob counterclockwise to make the number more negative. As a digit is incremented past 9 or a digit is decremented past 0, the adjacent digit is carried. **◀** and **▶** select digits to the right and left, and **Ampl Freq** selects the upper line (amplitude) and lower line (frequency).

If the output is adjusted beyond the capability of the Calibrator, the Calibrator beeps and does not allow the change.

Push **x10** and **÷10** to quickly verify the accuracy of different ranges of a UUT. When in error mode and these keys are pushed, the Calibrator output and the new reference are set to 10 times or 1/10 the previous reference value.

In the resistance output function, the edit controls show the UUT error in a similar way, except the output of the Calibrator does not change as the knob is turned. Instead, a reading on the display changes that can be matched to the reading on the UUT. As the reading is changed, the Calibrator computes and displays UUT error.

Read the UUT Error: AC and DC Voltage and Current Output

To read the error of the UUT in the ac and dc voltage and current output functions:

1. Set the necessary calibration voltage or current, as previously described under “Set the Output.”
2. Use the output adjustment controls as necessary to get a reading on the UUT equal to the original entry on the 5730A Calibrator. To increment or decrement a higher-order digit, push **◀**. As the reference value is approached, work progressively back towards the least-significant digit on the Calibrator display as necessary by pushing **▶**. It is only necessary to go one digit past the least significant digit of the UUT. Digits below that are beyond the resolution of the UUT. The UUT error is shown on the display. This example assumes that the Calibrator is in the dc voltage function:

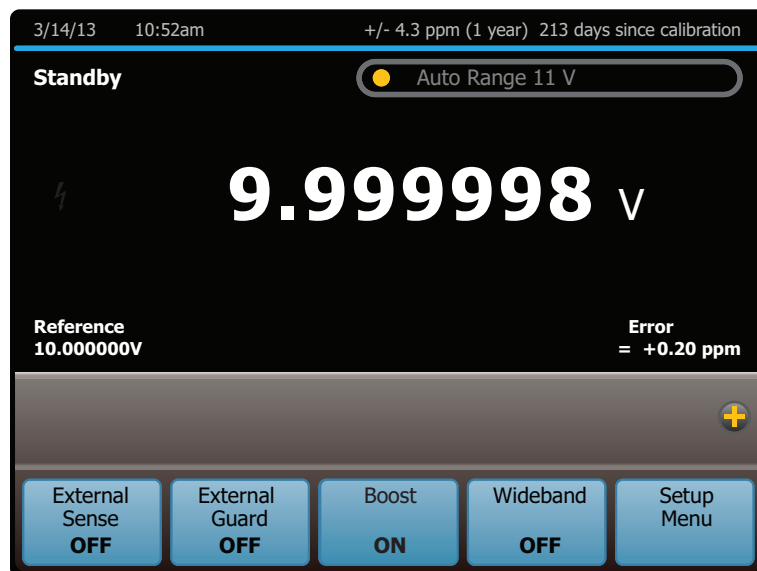

hhp132.eps

Read the UUT Error: Resistance Output

To read the error of the UUT in the resistance function:

1. Set the necessary resistance output as described under “Set the Output.”
2. Use the output adjustment controls as necessary to achieve a reading on the display (illustrated below) equal to the reading on the UUT. To adjust a higher-order digit, push **◀**. As the reference value is approached, work progressively back towards the least-significant digit on the 5730A Calibrator display as necessary by pushing **▶**. It is only necessary to go one digit past the least significant digit of the UUT.

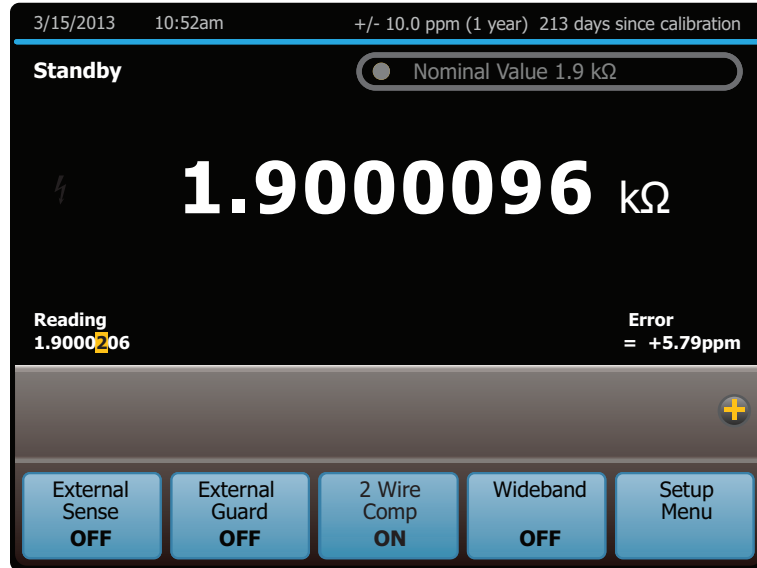

hhp133.eps

Introduction to Offset, Scale, and Linearity Errors

The performance of a DMM or meter can be plotted as a graph of input stimulus and meter reading. For a perfect meter, the graph of the input stimulus would exactly match the graph of the reading.

The 5730A Calibrator measures and shows three types of UUT errors:

- Offset Error
- Scale Error
- Linearity Error

Offset Error

Offset error can be measured directly by finding the Calibrator output that causes a meter reading of 0 V. This error is called an offset because it reflects a fixed error that is present in all meter output readings. For example, if a meter reads 0 V when -1.3 mV is applied, the meter has an offset error of +1.3 mV. Figure 4-7 illustrates this example.

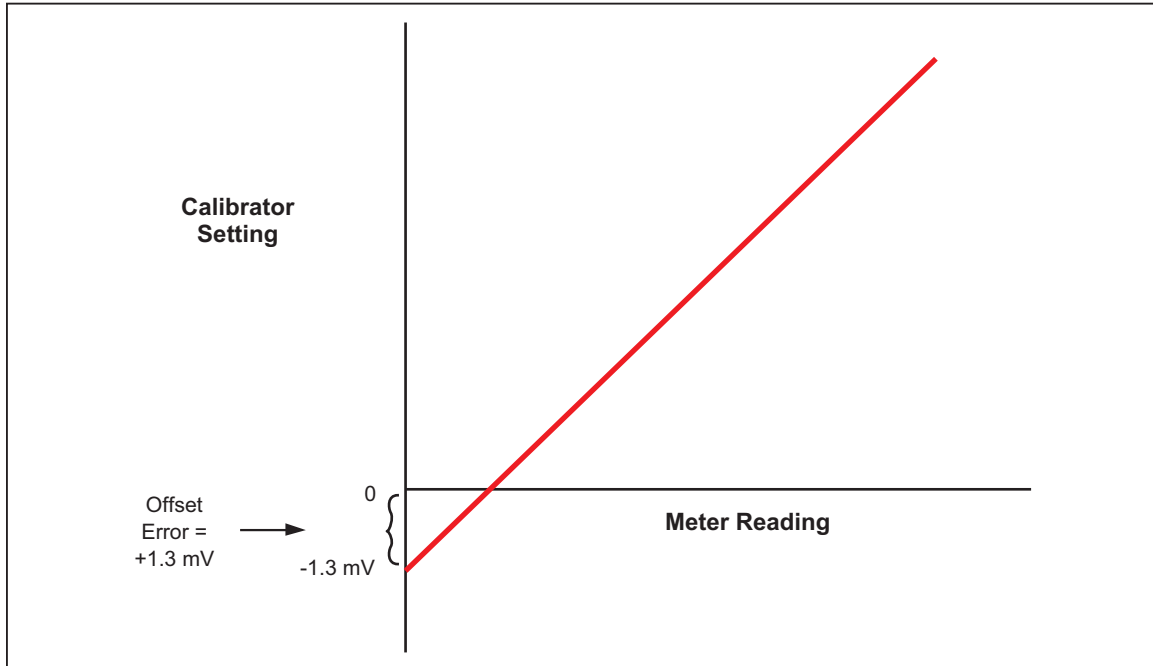

Figure 4-7. Offset Error

hhp052.eps

Scale Error

Scale error, sometimes referred to as gain error, occurs when the slope of the meter response curve deviates from one. A meter with only scale error (no offset or linearity error), will read 0 V when 0 V is applied, but will read a value other than 10 V when 10 V is applied. For example, if a meter reads 19.900 V when 19.903 V is applied, the meter has a scale error of -3 mV. To isolate scale error, offset error must first be subtracted. Scale error is then simply the error measured near the full-scale endpoint, or:

$$\text{Scale Error} = \frac{(\text{Reference full scale}) - (\text{Adjusted Calibrator Setting})}{(\text{Reference full Scale})}$$

Where “Adjusted calibrator setting” is the adjusted output (using the knob) that results in the UUT correctly reading “nominal full-scale.” Select a point just down from the UUT full-scale endpoint for nominal full-scale. This keeps the UUT from ranging while adjustments are made. For example, use 19.9 V as the nominal full-scale for a UUT that ranges at 20 V.

The example in Figure 4-8 assumes no offset error. The formula for scale error yields:

$$\text{Scale Error} = \frac{19.9 - 19.903}{19.9} = -0.000151 = -0.0151 \%$$

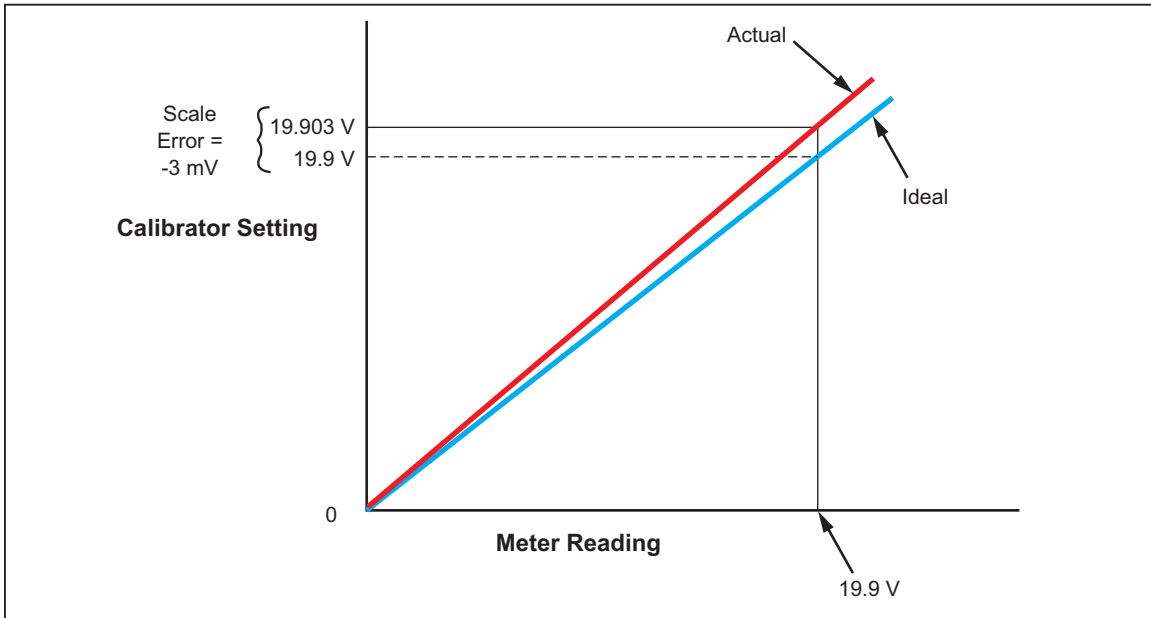

Figure 4-8. Scale Error

hhp018.eps

Linearity Error

Linearity error occurs when the response curve of a meter deviates from a straight line. This type of error is measured by fixing zero and near-full-scale endpoints on the response curve, drawing a line through the points, then measuring how far the meter response deviates from the straight line at various points. The error value is computed relative to the selected full-scale point. The formula for linearity error is:

$$\text{Linearity Error} = \frac{(\text{Nominal setting}) - (\text{Adjusted 5730A Setting})}{(\text{Nominal Full Scale})}$$

Where the “nominal setting” is calculated by subtracting the offset error and a proportional part of the scale error.

Figure 4-9 illustrates linearity error with both offset and scale errors assumed to be zero. The formula for linearity error yields:

$$\text{Linearity Error} = \frac{(10.0 - 9.993)}{19.9} = 0.000352 = +0.0352 \%$$

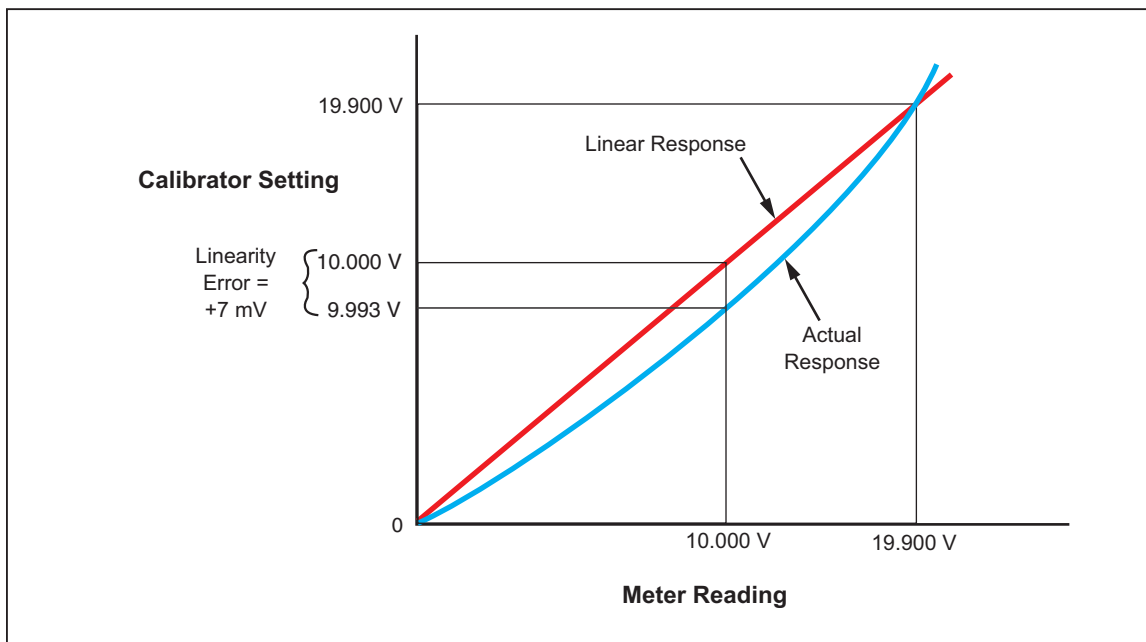

Figure 4-9. Linearity Error

hhp019.eps

Combine the Error Types

The actual error of a meter is the combination of all three types of errors. The Calibrator uses the **Scale** and **Offset** selections to separately show all three types of errors directly, without any calculation.

Program an Offset

The **Offset** selection can be used when in the dc voltage or current function any time it is necessary to offset the 5730A Calibrator output by a fixed amount. The **Offset** selection is shown by touching the + icon on the right of the display above the bottom row of selections. After an offset is established, it is subtracted from all later keyboard entries to compensate for a UUT offset error. Touch **Offset** again to turn off this offset. Both the offset value and the keypad-entered reference value are shown on the display, along with the true output value.

The **Offset** selection may be used to establish a zero-scale endpoint, this can then be used with the **Scale** selection to check the linearity of a UUT. (See the example under “Linearity Checking With Offset and Scale.”)

To program an offset:

1. Set the Calibrator to output 0 mV dc. The easiest way to do this is to push **Reset**, then push **OPERATE**.
2. Adjust the Calibrator output with the rotary knob (and arrow keys if necessary) until the UUT reads 0 V.
3. Touch **Offset**. This stores the output value as the offset value.

The Calibrator output value is now 0 V minus the offset value, in this example, the 1.3 mV output value is shown on the largest font on the Display. The Calibrator reference value is set to 0 V. The reference and offset values are shown on the display as seen below:

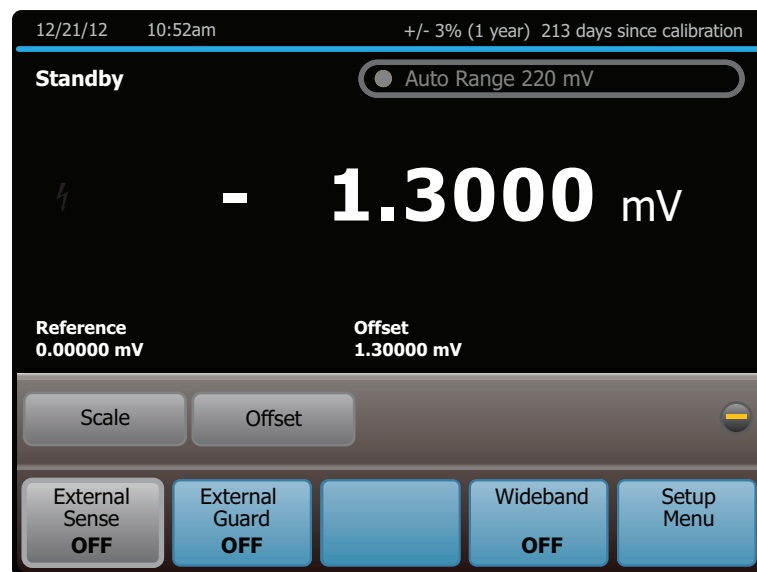

hhp134.eps

If a new value is entered, the offset value is subtracted from the new value to create the new output. The newly entered value becomes the new reference value shown on the display. For example, if 1 V is entered, the displayed true value is +0.99870000 V and the displayed reference is 1.0000000 V. The offset remains in effect until **Offset** is touched again, a different output function is selected, **Setup Menu** is touched, or **Reset** or **⏪** are pushed.

Program a Scale Factor

Use the **Scale** selection in ac and dc voltage and current functions to apply a scale factor to subsequent outputs. The **Scale** selection is shown by touching the + icon on the right of the display above the bottom row of selections. After a scale factor is established, the correct proportion of it is applied to all subsequent entries to compensate for a UUT scale error. Touch **Scale** again to turn off this scale. Both the scale error and the keypad-entered value are shown on the display with the true output value.

The **Scale** selection can be used to establish a reference full-scale endpoint. This endpoint can be used with the **Offset** selection to check the linearity of a UUT. (See the example under “Linearity Checking With Offset and Scale”.)

To program a scale factor:

1. Set the 5730A Calibrator to output a level just below the UUT full-scale endpoint. For example, use 19.9 V for a UUT that ranges at 20 V.
2. Adjust the Calibrator output with the rotary knob (and arrow keys if necessary) until the UUT reads the selected correct output level (19.9 V in this example).
3. Touch **Scale**. This stores a scale factor that would apply this adjustment if this output level were selected again.

Subsequent Calibrator output values will be scaled by this factor. In the example in Figure 4-8, the meter reading was 3 mV low at 19.9 V. To compensate, the Calibrator was adjusted to 19.003 V to get a reading of 19.9 V on the meter. Note that the Calibrator is adjusted in the opposite direction of the meter scale error. So, a factor computed in the subsequent equation is applied to subsequent Calibrator output settings until the Scale selection is cleared:

$$1 - \frac{19.9 \text{ V} - 19.903 \text{ V}}{19.9 \text{ V}} = 1.000151$$

Extending this example, if the Calibrator is now set to 10 V, the actual output shown on the display is 10.00151 V.

Linearity Check with Offset and Scale

With the 5730A Calibrator offset and scaling features, a UUT offset and scale errors can be removed to isolate and display linearity error. The subsequent procedure is an example that uses the **Offset** and **Scale** selection to determine both scale and linearity error of a 4 1/2-digit DMM. In this example, the DMM is set to the 20 V dc range, and the Calibrator is connected to the DMM. Figure 4-10 illustrates all three types of errors that are detected by the Calibrator. The numbers in the graph correspond to the conditions encountered in the example.

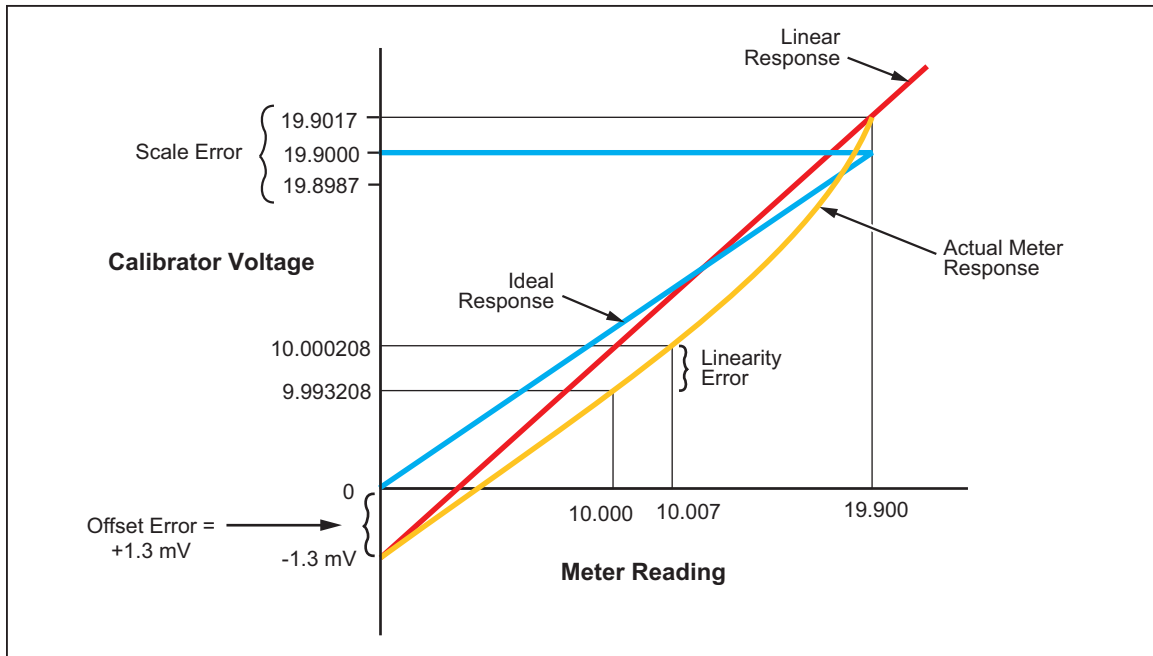

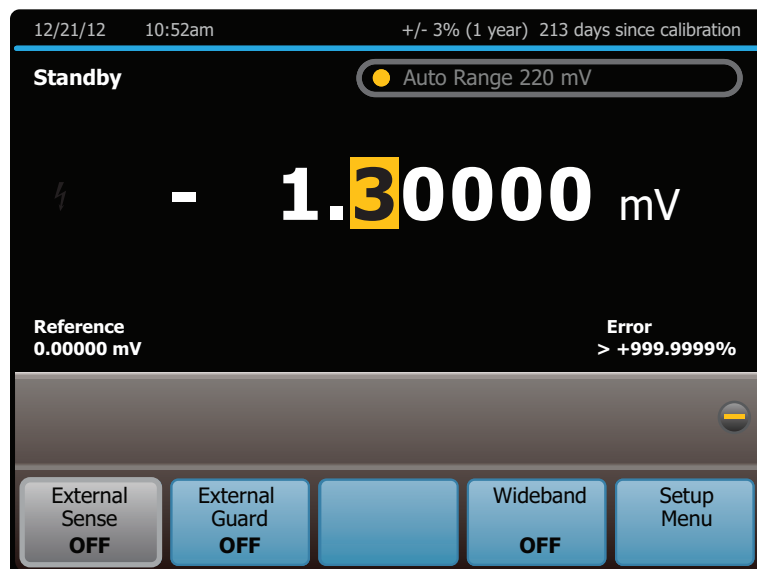

Figure 4-10. Meter Response vs. Stimulus

hhp020.eps

1. Set the Calibrator to 0 mV in standby.
2. Use the output adjustment controls (the rotary knob and ) to adjust the Calibrator output for a reading of 0 V on the DMM. The displays shows:



hhp136.eps

Note

The message “Error >+999.9999%” occurs because in this case the reference voltage is 0.

3. Touch **Offset** to identify this as the DMM zero-scale endpoint. The display changes to:

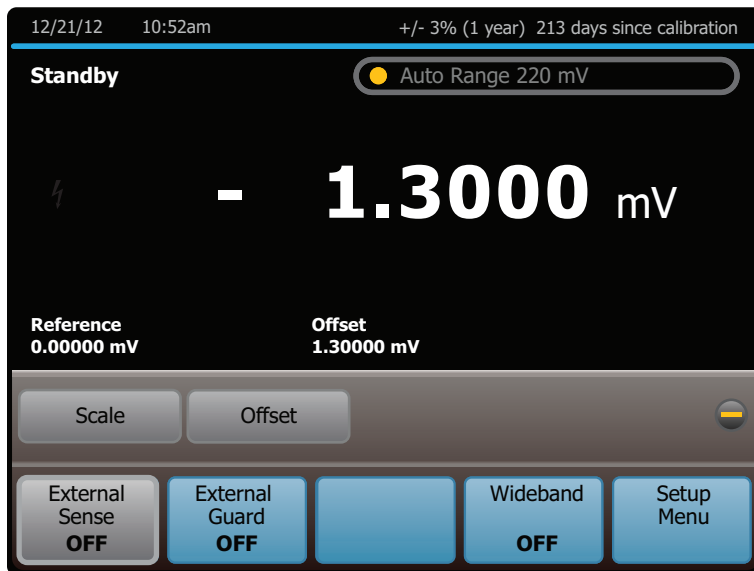

hhp137.eps

4. Use the numeric keypad to set the Calibrator to a point near the end of the DMM range. (This example uses 19.9 V.) The displays change to:

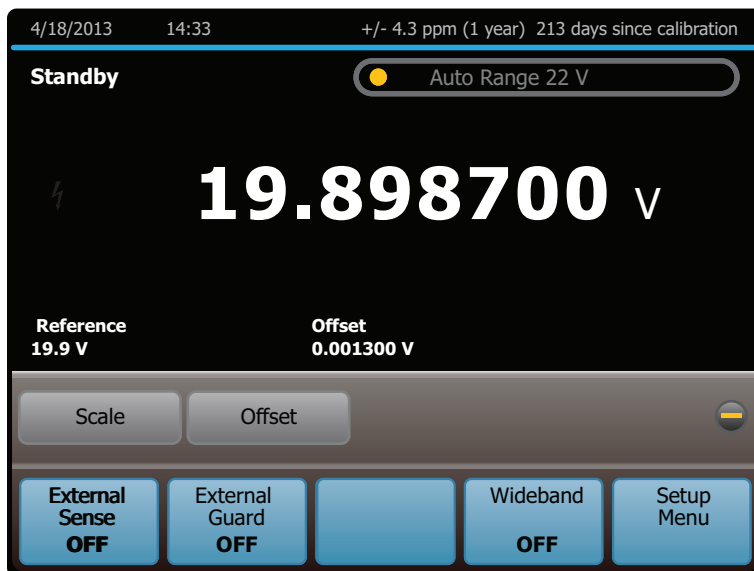

hhp138.eps

5. Use the output adjustment controls to adjust the Calibrator output for a reading of 19.9 V (the reference value) on the DMM. The displays change to:



hhp139.eps

6. Touch **Scale** to identify this as the full-scale endpoint for the DMM range.
7. To check the linearity error of the DMM, select an output at a linearity checkpoint somewhere in the middle of the range, such as 10 V. If 10 V is entered, this changes the display to:



hhp140.eps

The 10.000208 V output setting is calculated by the Calibrator with the subsequent equation:

$$1 - \frac{19.9 \text{ V} - 19.903 \text{ V}}{19.9 \text{ V}} = 1.0001508$$

This is applied to 10 V to yields:

$$10 \text{ V} \times 1.0001508 = 10.001508 \text{ V}$$

The 1.3 mV zero offset is then subtracted:

$$10.001508 \text{ V} - 0.0013 \text{ V} = 10.000208 \text{ V}$$

8. Use the output adjustment controls to adjust the Calibrator output for a reading of 10.0 V (the reference value) on the DMM. The displays change to:

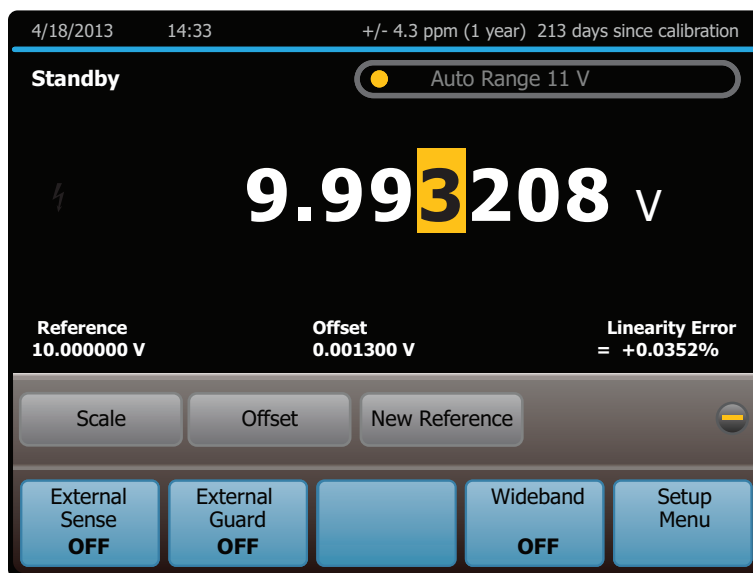

hhp141.eps

The display now shows that the DMM scale error at 19.9 V is -0.0151 %, and the DMM linearity error at 10 V is +0.0352 %.

Set up the Calibrator

The remaining sections of this chapter explain how to set up the Calibrator.

Setup Menu

The Setup Menu grants access to various operations and changeable Calibrator parameters. Once a parameter is set, it is saved in memory until it is changed. Any changes are saved during power-off periods.

When **Setup Menu** is touched from the normal operation screen, the display shows the Setup Menu:

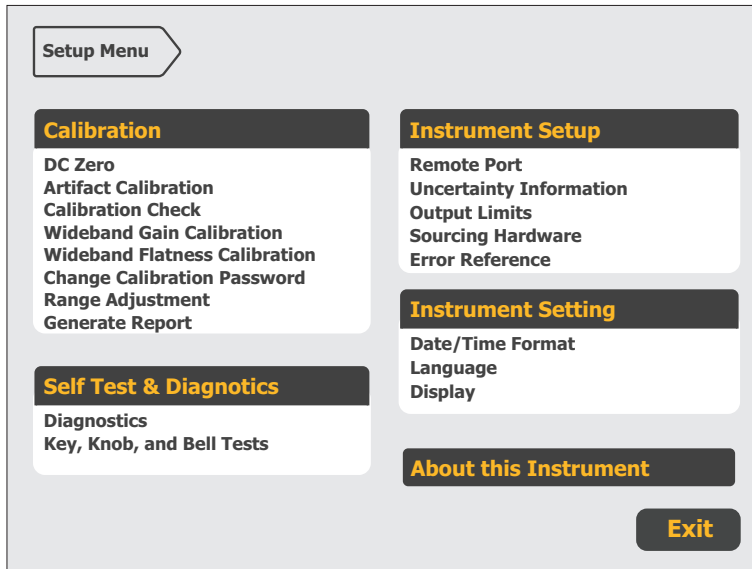

hhp104.eps

The subsequent list briefly describes the submenus available from the Setup Menu.

- **Calibration-** The items in this submenu are used to activate calibration to external standards, Calibration Check, DC Zeros, and to verify or adjust the 5730A Calibrator calibration to its specifications. The Calibration submenu and process is explained in greater detail in Chapter 7.
- **Self Test & Diagnostics-** Use this submenu to do automatic internal self-diagnostics on various features of the Calibrator. Once started, the self-diagnostic cannot be interrupted. The Calibrator must be completely warmed up to run the self-diagnostics or the process will timeout and prompt to let the Calibrator warm up.

The submenu also has a **Key, Knob, and Bell Test** that can be run from this point. The key and knob test take input from the front-panel keys and rotary knob and return visual identifiers that the key being pushed returns what it should. For example, if **ENTER** is pushed, “**Enter**” is returned in the blank field of the submenu. When **Run Bell Test** is pushed, an internal bell will sound.

- **Instrument Setup-** Use this menu to:
 - Choose and configure remote interfaces (see Chapter 5).
 - Set parameters to compute output uncertainty.
 - Impose limits on the Calibrator output for safety and external equipment protection.
 - Select boost amplifiers for voltage and current outputs.
 - Enable or disable the ability to turn on or off ac transfers (real-time measurements and adjustments of the value after the output is settled).
 - Choose the error reference value (nominal or true value) used to compute unit under test (UUT) errors.

The Instrument Setup submenu is explained in greater detail later in this chapter.

- **Instrument Settings-** Use this menu to:
 - Set the date and time as well as its format.
 - Select the user interface language.
 - Control the display brightness

The Instrument Settings menu is explained in greater detail later in this chapter.

- **About this Instrument-** This shows hardware configuration and software version information for the Calibrator. Nothing can be changed from this section.

Setup Menu Rules

Each menu has a path shown at the top of the display that shows the current location in the menu structure. This gives access to the menus used to get the present point. For example, if **Setup Menu** is touched from the normal operation screen, the top of the Setup Menu shows:



This type of symbol designates the top-level of the menu structure. For this manual, menu paths are shown as in the subsequent example to reach the Remote Port menu:

Setup Menu>Instrument Setup>Remote Port

This example shows the path to this Remote Port section of the menu structure:

Setup Menu was the start point, then **Instrument Setup** was touched, and finally **Remote Port** was touched to get to the Remote Port menu.

Conversely, from the Remote Port menu, touch **Instrument Setup** to go up one level, **Setup Menu** to go up two levels.

An **Exit** or **Cancel** selection in the lower right of the display closes the menus or stops a process. The 5730A Calibrator then returns to the normal operation screen.

Menu Description

A menu item that leads to a submenu with multiple selections has a black and amber title bar on top followed by a list of the items in the submenu. The Instrument Setup menu is shown in this example:

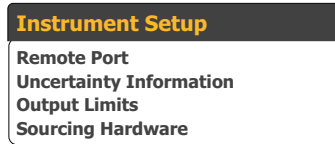

To get to the submenus, touch anywhere in the menu shown.

Touchscreen Selections

When applicable, settings controlled by touchscreen selections are shown in this manner:

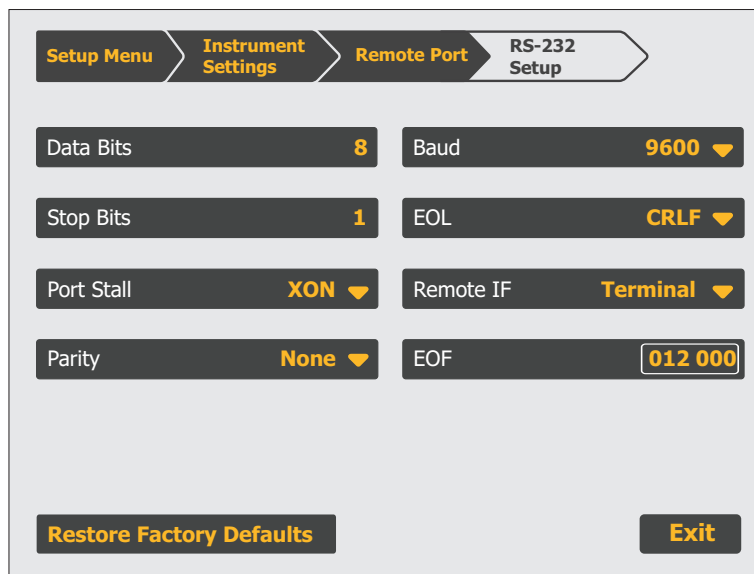

hhp149.eps

Each of the touchscreen selections shown above change a parameter or reveal more changeable parameters.

Some selections do not have submenus beneath them or do not include changeable items. For example, in the display below, the **About this Instrument** selection has no changeable items.

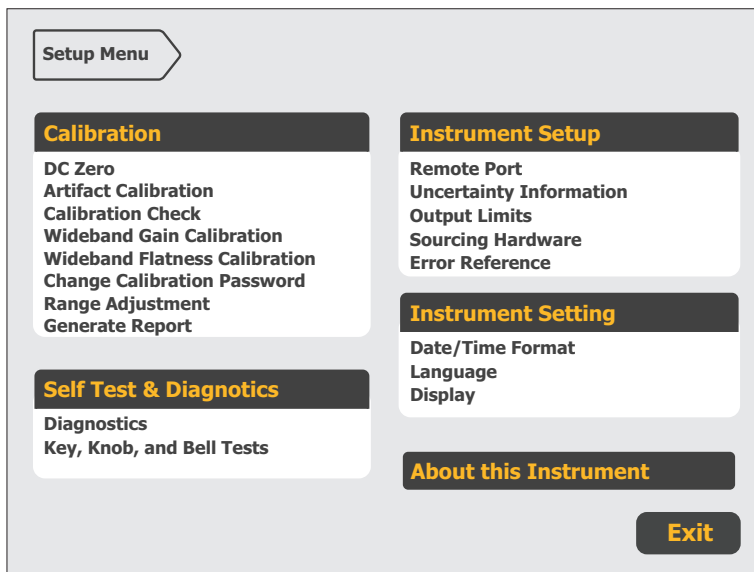

hhp104.eps

About this Instrument opens a page to show non-editable information about the Calibrator hardware and software.

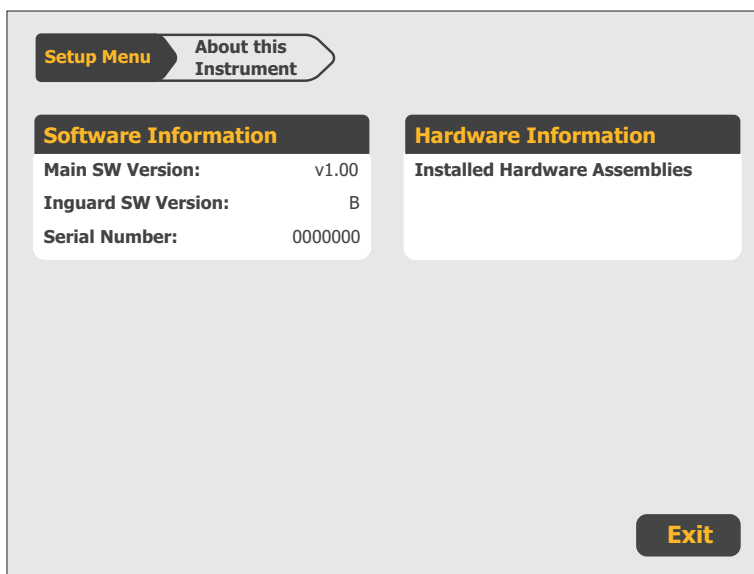

hhp156.eps

There are selections without a submenu listed beneath them that are used to start processes. For example, the **Run DC Zero** selection from the Calibration menu starts the DC Zero process (see Chapter 7).

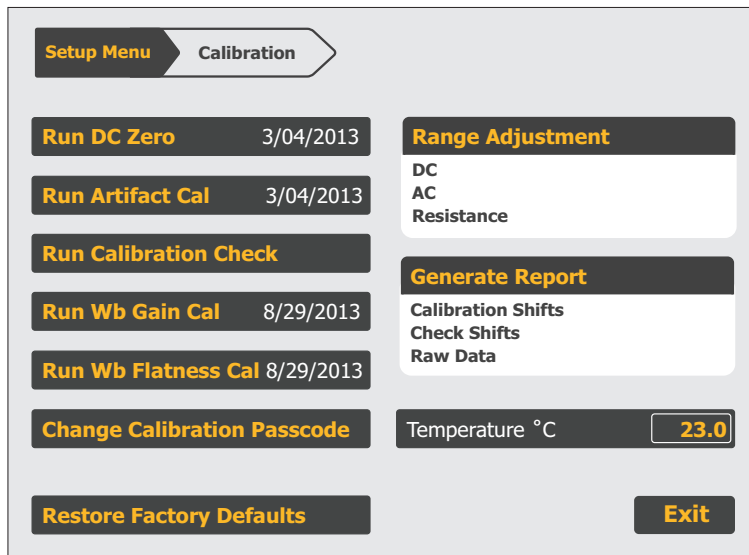

hhp173.eps

There are several types of selections that are used for settings. In general, these selections show what is being set in white, and the value that it is currently set to is in amber. See the **Temperature °C** selection in the screen above.

Touchscreen selections with two possible values look like the **Confidence Level** selection shown in the screen below. Touch **Confidence Level** to change the value from 99% to 95%. Touch it again to change the value back to 99%.

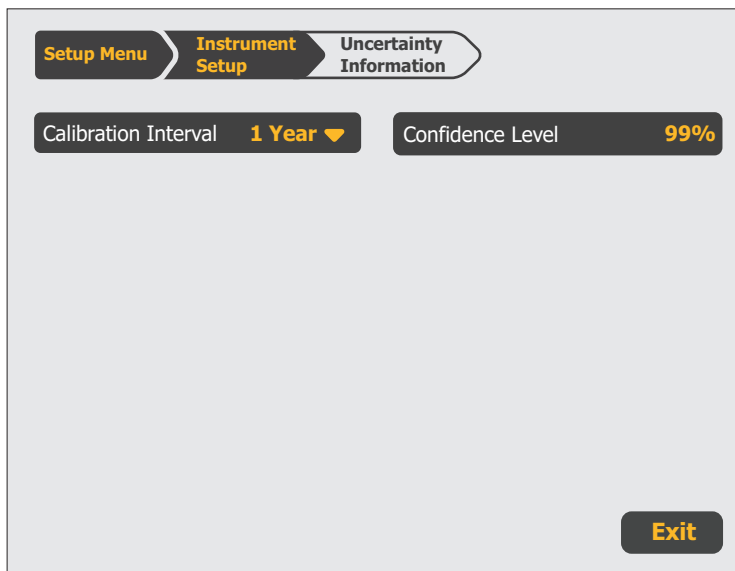

hhp107.eps

Touchscreen selections with several possible values look like the **Calibration Interval** item shown in the screen above. Touch the selection to open another menu with a selection for each possible choice as shown below.

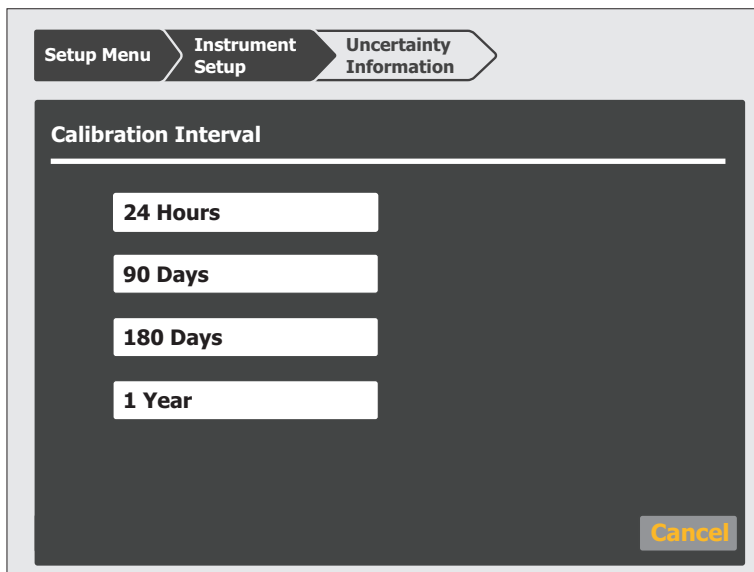

hhp152.eps

Touch a value to select it or touch **Cancel** to abort the value change.

Touchscreen selections with many possible values look like the **Port** selection in the Ethernet Setup menu shown here:

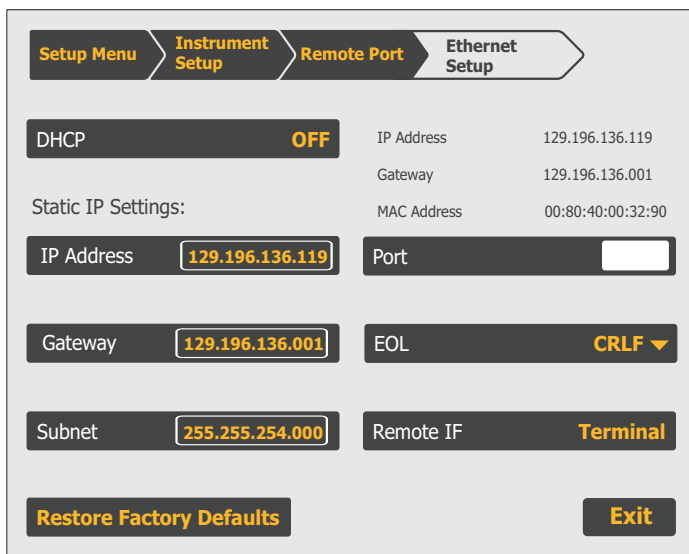

hhp153.eps

To change the value, touch the present value and then enter a new value with the numeric keypad.

Some of the setup menus have a **Restore Factory Defaults** selection. If this selection is touched, a confirmation is requested. Touch **Restore** to reset the Calibrator to factory defaults or **Cancel** to make no changes.

Instrument Setup

The Instrument Setup menu (accessed by touching the **Instrument Setup** selection in the Setup Menu) is shown on this screen:

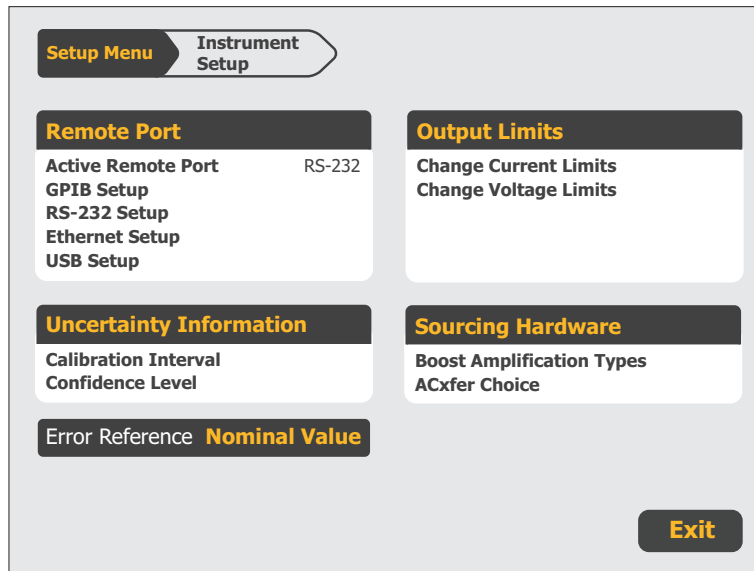

hhp105.eps

The list below briefly describes submenus accessed by each touch screen selection. These items are described in more detail later in this chapter.

- **Remote Port Setup-** opens setup menus for the IEEE-488 instrument control port and the RS-232 serial interface port. Chapter 5 describes how to set up the IEEE 488 interface and the serial interface.
- **Uncertainty Information-** set the confidence level and calibration interval on which uncertainty specifications are calculated.
- **Error Reference-** When the output value is edited, the display shows the difference between the reference value and the edit value. This is explained in more detail later in this chapter.
- **Output Limits-** limit the possible voltage or current output of the Calibrator for safety or to protect external equipment.
- **Source Hardware-** select external boost amplifiers for high ac voltage and current outputs, and also allows ac/dc transfers to be turned off once the output is settled.

The AC Transfer Choice (**ACxfer Choice**) feature activates **ACxfer Off**, when in the ac voltage or current output function. This turns off the monitoring system that makes adjustments for load changes. The AC Transfer Off feature is available only in ranges below 220 V at frequencies below 120 kHz.

AC Transfer Off stays active until the Calibrator is reset or the power is turned off. For remote control applications, the same feature is accessible through the remote command Transfer Off. Send the command Transfer On to restore internal ac transfers to normal operation.

To turn off internal ac transfers:

1. Touch **Setup Menu>Instrument Setup>Sourcing Hardware>ACxfer Choice** until **Enable** is shown. This causes the AC Transfers selection to be shown on the main screen.
2. After you set the output for an ac voltage, touch the + sign to show the **ACxfer** selection.
3. Touch **ACxfer** it until it says OFF.

Uncertainty Information Menu

From the Instrument Setup menu, touch **Uncertainty Information** to open the menu shown below. This menu shows options to configure the specification confidence level, and to set the calibration interval.

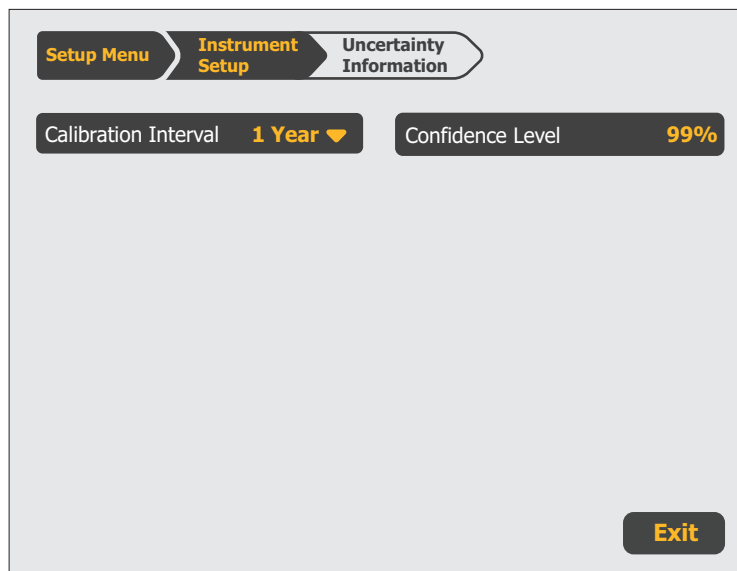

hhp107.eps

The function of each selection is described below:

- **Calibration Interval**- sets the calibration cycle to 24 hours, 90 days, 180 days, or 1 year.
- **Confidence Level**- sets the calibration specification confidence level to 95 % or 99 %. All specifications are provided in Chapter 1 of this manual.

Set Output Limits

An output limit feature is available to help prevent accidental damage to a UUT from overcurrent or overvoltage conditions. The maximum positive and negative allowable voltage or current output can be preset with this feature. Entry limits that are set prevent any input greater than the limit from being activated by entry through the front-panel keys or the output adjustment controls. Positive limits for voltage and current set the limits for ac voltage and current. Default entry limits after power-up or **Reset** is pushed are the specified maximum and minimum for each output function.

Note

The output limits are not saved when the Calibrator is powered down.

To set voltage and current entry limits:

1. Touch **Setup Menu>Instrument Setup>Output Limits**. This menu is shown:

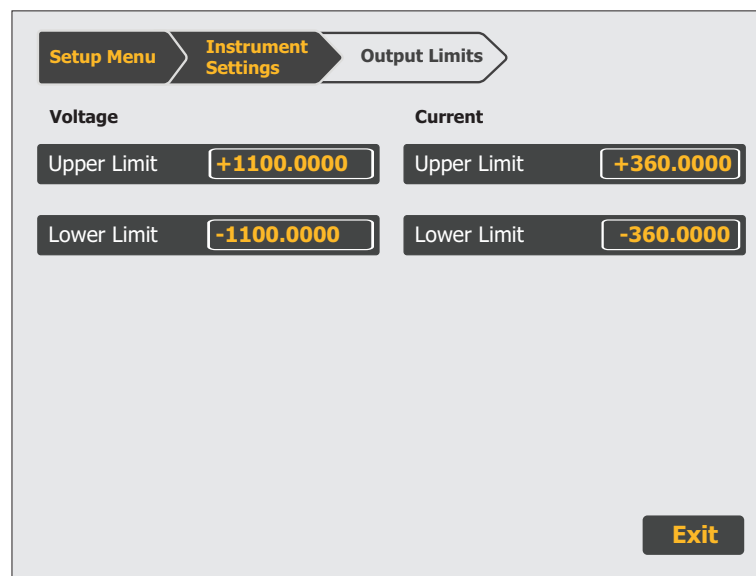

hhp143.eps

2. There is a selection for each of the four limits: maximum positive voltage and current and negative voltage and current. Select the limit to change by touching the corresponding selection.
3. Use the numeric keys to enter the necessary voltage limit and **μ**, **m**, or **k** if necessary, followed by **ENTER**.

Note

The upper voltage limit sets the limits for both dc and ac voltage. The upper current limit sets the limits for both dc and ac current.

Select Boost Amplifiers

If an auxiliary amplifier other than the 5725A will be used, one amplifier can be identified for current boost and one amplifier can be identified for voltage boost. Model 5725A is the factory default for both voltage and current boost. To select other amplifiers:

1. Touch **Setup Menu>Instrument Setup>Boost Amp Types**.

(If the Setup Menu is not shown, push **Reset** first).

The display changes to:

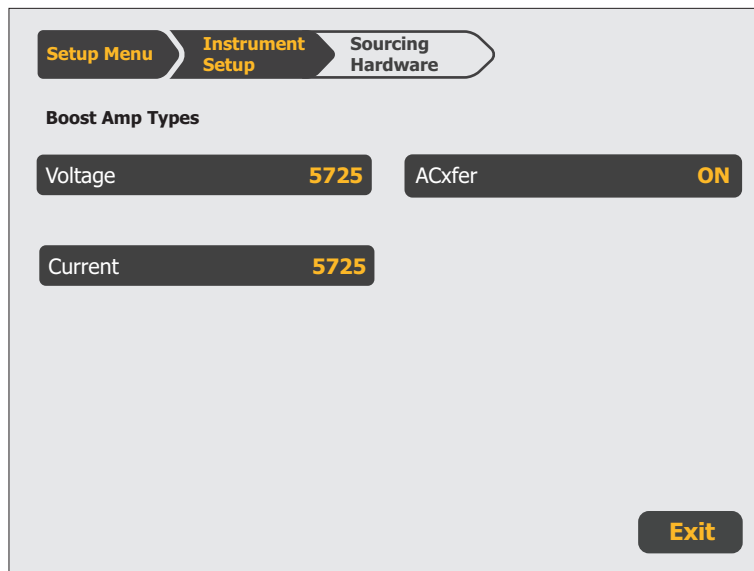

hhp111.eps

2. Touch **Current** to scroll the highlighted label until it shows 5725 or 52120.
3. To go to normal operation, touch **Exit**.

Error Reference

When the output value is edited, the display shows the difference between the reference value (the value originally entered) and the edit value (the value shown on the display), displaying error difference in parts per million (ppm) or percent (%).

For example, an edited difference of 0.00030 volts for an output of 10.00000 V represents $0.00030/10.00000=0.000030$, or 30 parts per million. The sign is negative (-30.0 ppm) because the output necessary to display 10.00000 at the UUT shows the UUT is reading below the output value. When the reference is negative, the error sign is relative to the magnitude. For example, if the reference is -10.00000 V and the display is -10.00030, the error is -30 ppm or -0.0030 %.

The 5730A Calibrator has two methods of scaling the UUT error. The first method, called the “nominal” method is used in the Fluke Calibration 5700A, 5720A, 5502A, and 5522A calibrators.

The second method is called “true value”. Both methods can be used in this Calibrator. The nominal method of error calculation uses the formula:

$$\frac{\text{reference value} - \text{edit value}}{\text{reference value}}$$

The nominal method is useful to check the error of the Calibrator itself, when its performance is verified against a more accurate measuring device.

The true value method of error calculation uses the formula:

$$\frac{\text{Reference value} - \text{edit value}}{\text{edit value}}$$

With either the nominal or true value method, small changes in output value result in a calculated error that is the same. In the example above, the display will show the error as -30.0 ppm.

The true value method is useful for large changes in output value. For example, if 10.0000 V is applied to an analog meter, and then the Calibrator output is adjusted to 11.0000 V so that the analog meter now reads exactly 10 V, the true value method will show:

$$\begin{aligned} \text{nominal} &= +10.0000 \text{ V} \\ \text{rel err} &= -9.0909 \% \end{aligned}$$

-9.0909 % represents the relative error of the analog meter when compared to the true value (11.0000 V in this case).

To select the UUT error calculation method:

1. Touch **Setup>Instrument Setup**.
2. Touch **Error Reference** until it shows the desired choice. The choices are "Nominal Value" or "True Value."

Instrument Settings

Set the Internal Clock/Calendar

An internal clock/calendar provides the date (corrected for leap years) and time to the Calibrator CPU (Central Processing Unit). The clock setting should be checked and set if necessary.

Note

A long-life lithium battery keeps the clock/calendar running during power-off periods. If the battery in the Calibrator should ever need replacement, contact a Fluke Calibration Service Center.

To set the date or time, enter a security passcode. Touch **Setup Menu>Instrument Settings>Date/Time**. The display is shown below.

The time can be set without the security passcode. The security passcode is explained in “Calibration Security Passcode”.

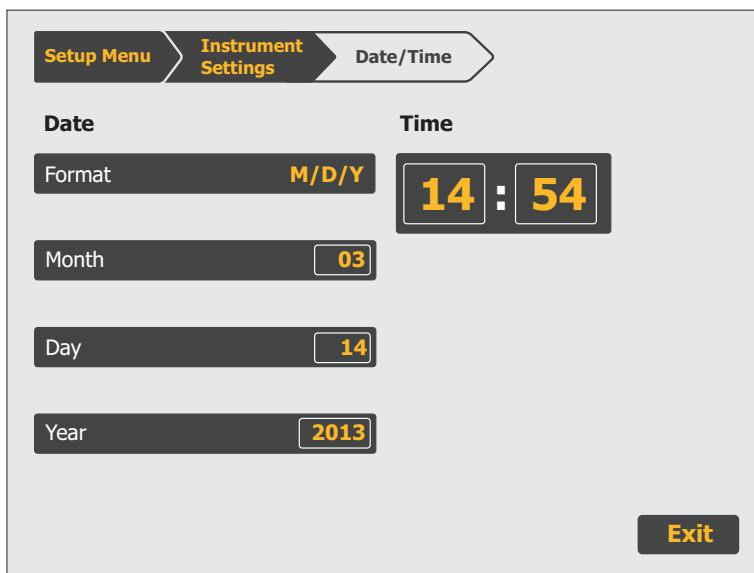

hhp108.eps

Language

To select the display language used for the 5730A Calibrator UI:

1. Touch **Setup Menu>Instrument Settings>Language**.
2. Touch the necessary language from the screen. The choices are:
 - English
 - French
 - Spanish
 - Simplified Chinese
 - Japanese
 - German
 - Portuguese
 - Russian
 - Korean

Note

The new language does not take effect until the Calibrator is powered down and back up again. Push  on the front panel.

Display Brightness

To adjust the brightness of the display:

1. Touch **Setup Menu>Instrument Settings>Display**.
2. Touch the field in the **Brightness** selection and enter the necessary value with the numeric keypad. Note that with brightness setting of 0 %, the display is still visible.

About This Instrument

About this Instrument in the setup menu gives access to this information:

- Installed internal operating software revision letters.
- Whether the Wideband AC Module (Option 5730A/03 or 5730A/05) is installed.
- Which auxiliary amplifiers are attached, if any.

To view this information, touch **Setup Menu>About This Instrument**.

Much of the information is summarized in this menu. Touch **Software Information** to get more detail about the installed firmware. Touch **Hardware Information** to get more detail about installed assemblies and attached auxiliary amplifiers.

Chapter 5

Remote Interface Setup

Introduction

The 5730A Calibrator can operate under remote control of an instrument controller, computer, or terminal, as well as under direct local control from the front panel. Remote control can be interactive, with the user controlling each step from a terminal, or can be set up to run automatically, taking commands from a computer within an automated system. This chapter explains how to connect, configure, and operate the Calibrator in remote mode.

The remote programmer uses a language of commands called “device-dependent commands” to duplicate the functions of the front panel controls.

The Calibrator has four remote interfaces: IEEE-488, RS-232 Serial, 100-baseT Ethernet, and USB 2.0. Only one interface may be used at a time. The interface is selected in the Remote Setup menu as described below.

Note

5700A/5720A Series II remote programs can be used to operate the 5730A.

Warning

The Product can produce voltages up to 1100V rms and must be programmed with caution to prevent hazardous voltages from being produced without sufficient warning to the operator.

Programs should be written carefully and tested extensively to ensure safe operation of the Product. Fluke Calibration recommends to include error-catching routines in your programs to ensure that the Product performs as intended. By setting the Service Request Enable register (SRE), described in Chapter 6, the Product can be programmed to cause an SRQ when an error is detected.

GPIB (IEEE-488) Interface

Use the IEEE-488 Port for Remote Control

The 5730A Calibrator is fully programmable for use on the IEEE Standard 488.1 interface bus (IEEE-488 bus). The interface is also designed in compliance with supplemental standard IEEE-488.2. Devices connected to the bus in a system are designated as talkers, listeners, talker/listeners, or controllers. Under the remote control of an instrument controller, the Calibrator operates exclusively as a talker/listener on the IEEE-488 bus.

IEEE-488 Bus Restrictions

The subsequent restrictions apply to all IEEE-488 systems:

1. A maximum of 15 devices can be connected in a single IEEE-488 bus system.
2. The maximum length of IEEE-488 cable used in one IEEE-488 system is either 2 m (6.56 ft) times the number of devices in the system, or 20 m (65.61 ft), whichever is less.

Bus Setup Procedure

To set up the 5730A Calibrator on the IEEE-488 bus, only a choice of address and the connection to a controller is necessary. To set up the bus:

1. With the Calibrator off, attach the IEEE-488 cable to the rear panel IEEE-488 connector. Fluke shielded cables Y8021 (1m), Y8022 (2m), or Y8023 (4m), are recommended.
2. Push  to turn on the Calibrator.
3. Touch **Setup Menu>Instrument Setup>Remote Port**.
4. The IEEE-488 bus address for the Calibrator is shown in the GPIB Setup region. To change it, touch the editable field and enter a new address with the numerical keys.
5. If the Active Remote Port is not GPIB, touch **Active Remote Port** and then touch **GPIB**.
6. Touch **Exit** to exit the Setup Menu.

IEEE-488 Interface Configuration

The 5730A Calibrator IEEE-488 interface supports the IEEE-488 interface function subsets listed in Table 5-1.

Table 5-1. Supported IEEE-488 Interface Function Subsets

Interface Function	Description
SH1	Complete source handshake capability
AH1	Complete acceptor handshake capability
T6	Basic talker; serial poll; no talk-only mode; unaddress if MLA
TEO	No extended talker capabilities
L4	Basic listener operation; no listen-only mode; unaddress if MTA
LEO	No extended listener capabilities
SR1	Full service request capability with ability to bit-mask SRQ
RL1	Full remoter/local capability including local lockout
PPO	No parallel poll capability
DC1	Device clear capability
DT0	No device trigger capability
C0	No bus control capability

Bus Communication Overview

Communication between the controller and the 5730A Calibrator takes place with commands established by IEEE-488 standards and commands specifically related to the Calibrator. The commands in Tables 6-4, 6-5, and 6-6 are all the remote commands, both common and device-dependent.

Definitions of the different types of messages used on the IEEE-488 bus follow:

- Device-dependent commands are messages used to transfer information directly between the 5730A Calibrator and the IEEE-488 controller. Some commands cause an action to take place in the Calibrator. Others, called queries in the IEEE standards, ask for information, and always generate a response message from the Calibrator. While message format is governed by IEEE-488 standards, messages themselves can be unique to the Calibrator. For example, device-dependent commands are used to set the output mode and amplitude, and to switch from standby to operate.
- Common commands defined by IEEE standards are used for functions common to most bus devices. Examples include the command to reset a device (*RST) and the query for device identification (*IDN?). Common commands and queries can be identified easily because they all begin with an asterisk (*).
- Interface messages defined by IEEE standards have their own control lines, and others are sent over the data lines by first asserting the control line ATN (Attention). An important thing to note about interface messages is that unlike device-dependent and common commands, interface messages are not sent literally (For example, when a device-dependent query is sent to the Calibrator, the controller automatically sends the interface message MTA (My Talk Address).

RS-232 Serial Interface

Use the RS-232 Port for Remote Control

This procedure is intended for those who use the 5730A Calibrator serial interface for remote control from a terminal or computer with a serial interface.

This section describes how to set up the RS-232 interface for remote control with protocol similar to IEEE-488. This chapter provides all details on data transmission.

The RS-232 interface is designed in accordance with EIA (Electronic Industries Association) standard RS-232.

RS-232 Interface Specifications

The RS-232 interface is configured as DTE (Data Terminal Equipment). A null-modem cable with two female 9-pin subminiature D connectors must be used to connect the 5730A Calibrator to other DTE (Data Terminal Equipment) such as a typical computer serial interface. Recommended cable is a Fluke RS43.

The choices available and the defaults for all programmable interface parameters for the Calibrator are shown in Table 5-2.

Table 5-2. RS-232 Interface Parameter Choices

Parameter	Choices	Default Setting
Data Bits	7 or 8	8
Stop Bits	1 or 2	1
Flow Control	Ctrl S/Ctrl Q, (XON/XOFF), RTS, or none	Ctrl S/ Ctrl Q
Parity Checking	Odd, even, or none	None
Baud Rate	9600, 19200, 38400, 57600, or 115200	9600
EOL (End of Line)	CR, LF, or CR LF	CR LF
EOF (End of File)	Any two ASCII characters	No characters

Set Up and Connect the Serial Interface

Refer to the specifications for the peripheral device, and proceed as follows to set up the serial interface for the application:

1. With the 5730A Calibrator power off, connect a 9-pin D subminiature RS-232 null-modem cable such as Fluke accessory RS43 to the rear panel RS-232 connector and to the peripheral device.
2. Push  to turn on the Calibrator.
3. Touch **Setup Menu>Instrument Setup>Remote Port Setup>RS-232 Port Setup**.

The display changes to:

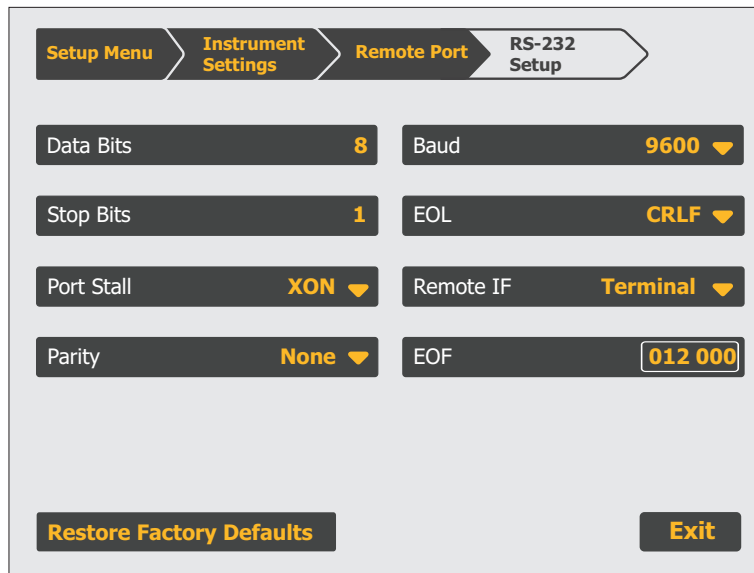

hhp149.eps

4. Touch **Data Bits** to set the number of data bits.
5. Touch **Stop Bits** to set the number of stop bits.
6. Touch **Stall** to select a method of stall control.
7. Touch **Parity** to select the parity mode.
8. Touch **Baud** to set the baud rate.
9. Touch **EOL** to set the EOL (End Of Line) character to CR, LF, or the string CR LF.
10. This step needs to be done only if setting up the interface for remote control of the Calibrator. Touch one of the selections under **Remote IF** to set the label to “Terminal” or “Computer.”

“Terminal” sets the remote port to expect a human operator to be using a terminal attached to the RS-232 port to control the Calibrator. This setting has the same effect as specifying TERM in the SP_SET or REM_MODE remote command parameter string.

“Computer” sets the remote port to expect a computer to be controlling the Calibrator over the RS-232 port. This setting has the same effect as specifying “COMP” in the SP_SET or REM_MODE remote command parameter string.

11. To designate a character or character string as the EOF (End Of File) character, touch **EOF**.
12. Enter the decimal code of the ASCII character(s) designated as EOF. (Appendix B contains a table of ASCII codes.) Verify that the selection is correct as shown on the display.
13. To exit the setup menus, touch **Exit**.

Serial Remote Control Setup Procedure

1. Turn on the 5730A Calibrator.
2. Touch **Setup Menu>Instrument Setup>Remote Port**.
3. The RS-232 setup details are shown in the RS-232 Setup region. To change any of these, select the region. See section “Set up and Connect the Serial Interface” section for more.
4. If the Active Remote Port is not RS-232, touch **Active Remote>RS-232**.
5. Touch **Exit** to exit the Setup Menu.

Exceptions for Serial Remote Control

When the RS-232 port is used to remotely control the 5730A Calibrator, either interactively with a terminal or under computer control, operation is the same as with an IEEE-488 controller connected to the IEEE-488 port for control. These are exceptions:

1. Control/C does the same function as DCL (Device Clear) or SDC (Selected Device Clear).
2. The EOL (End of Line) input terminator is Carriage Return (Control/M) or Line Feed (Control/L). All output lines are terminated by the terminator programmed in a setup menu, or set with the remote command `SP_SET`. This setting applies to all lines, including those with the `*PUD` command (see number 4).
3. Control/R echoes to the port a Carriage Return, a Line Feed, and any uncompleted remote command entered. This shows a copy of whatever has been entered since the last command.
4. For the `*PUD` (Protected User Data) Command, that stores characters for later recall, the serial remote interface does not store the subsequent characters: Control/C, Line Feed (Control/J), Carriage Return (Control/M), Control/R, Control/S (XOFF), Control/Q (XON). These characters are processed as described above. They cannot be a part of the `*PUD` command. The `*PUD` command terminates with Line Feed or Carriage Return, the same as all other serial remote commands.
5. There is no SRQ capability when serial remote control is used. The status registers still behave as described in this section, but the Calibrator serial interface does not have a way to perform the SRQ function.
6. There are three special commands available only for serial/Ethernet/USB remote control. These are described in Table 6-6.

Ethernet Interface

The subsequent sections describe how to use an Ethernet interface with the Calibrator.

Set Up and Connect the Ethernet Interface

Refer to the specifications for the LAN network, and proceed as follows to set up the Ethernet interface for the application:

Touch **Setup Menu>Instrument Setup>Remote Port Setup>Ethernet Setup** to get to the Ethernet Setup menu.

When addressing some LAN addresses, computers will often interpret zeros in the IP address as OCTAL values. As an example, if the IP address is configured from the front panel as 129.196.017.023 and then a connection to the 5730A Calibrator is attempted, connect with the IP address 129.196.17.23. Attempts to establish a connection to 129.196.017.023 may result in a connection request to 129.196.15.19.

Set the IP Address

An internet (IP) address is necessary for all internet and TCP/IP communications. If DHCP is enabled, the 5730A Calibrator will use the dynamic address supplied by the DHCP server. If the DHCP server fails to supply the address, the IP address will be shown as "0.0.0.0".



Select the Dynamic Host Configuration Protocol (DHCP)

Dynamic Host Configuration Protocol (DHCP) is a client-server protocol that eliminates the manual set up of permanent/static IP addresses. The DHCP server provides configuration parameters (dynamic IP address, subnet mask, and default gateway IP addresses) that are necessary for a client to participate in an IP network.

DHCP is the easiest way to configure the 5730A Calibrator for remote communication through the LAN interface. DHCP is enabled by default when the Calibrator is shipped from the factory. When connected to a network, and the LAN port is enabled, the Calibrator attempts to retrieve the parameters from a DHCP server necessary for communications.

To disable or enable DHCP on the Calibrator, from the LAN menu, touch **DHCP**. If DHCP is already enabled, ON is shown on the selection label.

To use DHCP addressing:

1. Connect a LAN cable from a hub to the LAN port on the back of the Calibrator.
2. Touch **Setup Menu>Instrument Setup>Remote Port>Ethernet Setup** to get to the Ethernet Setup menu.
3. Select **DHCP**.
4. Push  to turn off the Calibrator.
5. Push  to turn on the Calibrator.

From the Ethernet Setup menu, the dynamic IP address assigned to the Calibrator can be checked.

Set a Static Internet Address

The 5730A Calibrator comes from the factory with 169.254.001.001 in the static IP address register.

Note

If the Calibrator is to be used on a corporate LAN and DHCP is not used, contact the network administrator for a static IP address to be used exclusively by the Calibrator. DHCP must be disabled to set a static IP address.

To change the Calibrator static IP Address:

1. Touch **Setup Menu>Instrument Setup>Remote Port>Ethernet Setup** to get to the Ethernet Setup menu.
2. Touch **IP Address**.
3. Use the numeric keypad to enter the IP address and then push **ENTER**.

If a mistake is made when the IP address is entered, **CE** must be pushed.

Note

*The IP address is stored in non-volatile memory, and does not change when power is removed and reapplied to the Calibrator or when the Calibrator receives an *RST command.*

Configure the General Network Socket Port

In order to communicate with each other, a client computer and the 5730A Calibrator must use the same socket port number. The default port is 3490. Typically, the default port does not need to be changed. If the socket port must be changed, enter the Socket Port number supplied by the network administrator.

To change the Socket Port number:

1. Touch **Setup Menu>Instrument Setup>Remote Port>Ethernet Setup** to get to the Ethernet Setup menu.
2. Touch **PORT**.
3. Use the numeric keypad to enter a new port number.
4. Push **ENTER**. The port number must be between 1024 to 65535.

If a mistake is made when the socket port is entered, push **CE** and go back to step 2 to enter the port number again.

Note

The Network Socket Port Number is stored in non-volatile memory.

Configure the LAN Default Gateway

The default gateway IP address is the IP address of a gateway (router) attached to the same network as the device. When the 5730A Calibrator detects that a client computer is not on the same network (using the network number), the data is sent through the gateway to reach the host computer.

The default for the Calibrator is “0” (no gateway, and subnetting is not being used).

To set the LAN Default Gateway address:

1. Touch **Setup Menu>Instrument Setup>Remote Port>Ethernet Setup** to get to the Ethernet Setup menu.
2. Touch **Gateway**.
3. Use the numeric keypad to enter the gateway address and then push **ENTER**.

If a mistake is made when the gateway address is entered, push **CE** and go back to step 4 to enter the port number again.

Set the LAN Subnet Mask

If communication between the client computer and the 5730A Calibrator passes through a router or gateway, and DHCP is disabled, it is necessary to set the subnet mask and default gateway address on both the client computer and the Calibrator. Get the correct subnet mask and gateway address from the network administrator.

The LAN Subnet Mask is a 32-bit number. This number is represented as four 3-digit segment numbers on the front-panel display. The default subnet mask set at the factory is 255.255.254.0.

To change the Calibrator subnet mask:

1. Touch **Setup Menu>Instrument Setup>Remote Port>Ethernet Setup** to get to the Ethernet Setup menu.
2. Touch **Subnet**.
3. Use the numeric keypad to enter the subnet mask and then push **ENTER**.

If a mistake is made when the subnet mask is entered, push **CE** and go back to step 3 to enter the address again.

Read the MAC Address

The MAC Address is set at the factory and cannot be changed. The MAC address can be read from the Ethernet Setup menu. The MAC address can also be accessed with a remote connection that uses the MACADDR? remote command.

Establish an Ethernet Connection

Telnet is the easiest method of establishing an Ethernet connection with the 5730A Calibrator. Telnet is a client-server protocol, based on TCP. The Telnet Protocol provides a fairly general, bi-directional, eight-bit byte oriented communications method. Telnet is available on all UNIX servers and on most PCs.

Telnet clients typically connect to hosts on socket port 23. The LAN connection to the Calibrator must be established with the specified Network Socket Port. See the “Configure the General Network Socket Port” section. When the remote interface port is changed to LAN from the Calibrator front panel, a LAN server is initiated in the Calibrator that listens for client connections on the socket port at the specified IP address.

To establish a LAN connection to the Calibrator from a computer with either UNIX, LINUX, or MS-DOS command prompts, do the subsequent procedure:

1. Touch **Setup Menu>Instrument Setup>Remote Port>Ethernet Setup** to get to the Ethernet Setup menu.
2. Change the remote interface port to Ethernet.
3. At the command prompt on the client computer, enter:

```
telnet <IP Address> <Socket Port>
```

As an example, if the IP address is known to be 129.196.136.131 and the Socket Port is set to 3490, at a command prompt from any client computer, enter:

```
telnet 129.196.136.131 3490
```

Once the internal LAN server connects with the client computer, the LAN server will reject any other connection attempts by other computers/clients and will “tunnel” a channel to the connected computer. This prevents multiple computers from trying to control the Calibrator.

Terminate an Ethernet Connection

To terminate the Ethernet connection, the Telnet session must be terminated on the client computer. Switching remote control ports will also terminate the Telnet session.

It may be necessary to terminate the Telnet session on the client computer but maintain the current LAN remote interface port selection. Client Telnet session termination can vary from computer to computer. Typically, terminating the shell (or command window in DOS) will terminate the Telnet session. When the client terminates the Telnet session, the LAN server in the Calibrator goes back into listen mode waiting for a new client to make a LAN connection request.

Use of Ethernet Remote Control

When the Ethernet port is used to remotely control the 5730A Calibrator, either interactively with a terminal or under computer control, operation is the same as with an RS-232 controller connected to the RS-232 port for control.

Use of USB 2.0 Remote Control

1. Touch **Setup Menu>Instrument Setup>Remote Port**.
2. If the Active Remote Port is not USB, touch **Active Remote Port**.
3. Touch **USB**.
4. Touch **Exit** to exit the Setup Menu.

When the USB port is used to remotely control the 5730A Calibrator, either interactively with a terminal or under computer control, operation is the same as with an RS-232 controller connected to the RS-232 port for control.

When USB remote operation is used, connect to the Calibrator with a virtual communication port on the computer and a terminal program such as PuTTY or HyperTerminal. When the USB remote control cable is disconnected, make sure to close the terminal program on the computer. This properly terminates the virtual communication port session in the computer. When the USB remote control cable is connected, open the virtual communication port on the computer from within the terminal program.

Chapter 6

Remote Commands and Syntax

Introduction

The syntax rules in this chapter apply to all the remote commands. A command consists of a word by itself or a word followed by one or more parameters. The rules for parameter syntax are provided first (including proper usage of units and multipliers), followed by the rules for extra spaces, then followed by the rules for terminator usage. A description of how the 5730A Calibrator processes incoming characters provides the basis for answering other possible questions about syntax. Information about syntax of response messages is also given.

Parameter Syntax Rules

Many of the remote commands require parameters, which must be used properly to prevent command errors. When a command error occurs, bit CME (5) in the Event Status Enable Register (ESE) goes to 1. General rules for parameter usage are:

1. When a command has more than one parameter, the parameters must be separated by commas. For example: "OUT 1 V, 100 HZ."
2. Numeric parameters may have up to 255 significant figures and their exponents may range from -32000 to +32000. The useful range for 5730A Calibrator programming is $\pm 2.2 \text{ E-}308$ to $\pm 1.8 \text{ E}308$.
3. Including too many parameters causes a command error.
4. Null parameters cause a command error (for example, the adjacent commas in "CLOCK 133700, , 071787").
5. Expressions, for example "(4+2*13)", are not allowed as parameters.

Units accepted in command parameters and used in responses are:

- HZ (frequency, hertz)
- MHZ (frequency, megahertz)
- V (voltage, volts)
- A (current, amperes)
- OHM (resistance, ohms)
- MOHM (resistance, megohms)

- DB (decibels)
- DBM (decibels referenced to 1 milliwatt for ac voltage amplitude)
- PCT (percent)
- PPM (parts per million)

Multipliers accepted in command parameters are:

- MA (mega, or unit x 1,000,000)
- K (kilo, or unit x 1,000)
- M (milli, or unit /1,000, except MOHM and MHZ)
- U (micro, or unit /1,000,000)

Some examples of allowed unit and multiplier combinations are:

- “MOHM” and “MAOHM” are both interpreted as megohms
- “MHZ” and “MAHZ” are both interpreted as megahertz
- “MV” is interpreted as millivolts
- “MAV” is interpreted as megavolts
- “MA” is interpreted as milliamperes

Extra Space Characters

Tables 6-5 and 6-6 and the remote program examples at the end of this chapter show commands and their parameters separated by spaces. One space after a command is necessary. All other spaces are optional. They are shown for clarity in the manual and may be left in or omitted as desired. Extra spaces can be inserted between parameters as desired. Extra spaces within a parameter are generally not allowed, except for between a number and its associated multiplier or unit.

Example:	Explanation:
“OUT 188.3 MA, 442 HZ”	Equivalent to “OUT 188.3MA, 442HZ”
“OUT - 110.041 V”	Invalid, no space allowed in a number
“OUT -110.041 V”	Correct form for above

Table 6-5 contains examples for commands whose parameters are not self-explanatory.

Terminators

To signal the end of a response sent to the controller, the 5730A Calibrator sends a “terminator.” For response message terminators, the Calibrator sends the ASCII character Line Feed with the EOI control line held high. The subsequent characters are recognized by the Calibrator as terminators when encountered in incoming data:

- ASCII LF character
- Any ASCII character sent with the EOI control line true

Incoming Character Processing

The 5730A Calibrator processes all incoming data as follows (except the 8-bit data byte portion of the *PUD parameter):

1. An eighth bit (DIO8) is ignored.
2. All data is taken as 7-bit ASCII.
3. Lower-case or upper-case characters are accepted.
4. ASCII characters whose decimal equivalent is less than 32 (Space) are discarded, except for characters 10 (LF) and 13 (CR) and in the *PUD command argument. *PUD allows all characters in its argument and terminates in a special way.

Response Message Syntax

In Table 6-5, responses from the 5730A Calibrator are described wherever appropriate. In order to know whether to read in an integer, a floating-point number, or character string, the first entry is (Integer), (Floating), or (String).

Note

The responses described in the command tables are correct for IEEE-488 remote control, and for serial/Ethernet/USB remote control in COMPUTER mode. TERMINAL mode (in serial/Ethernet/USB remote control), responses contain more descriptive text intended for an operator using a terminal interactively.

Integers for most controllers or computers are decimal numbers in the range -32768 to 32767. Response elements of this type are labeled as “integer” in the command tables. Floating-point numbers may be in exponential form, for example “1.15E-12”. String responses may be any ASCII printing characters. A special case of string response is in the CAL_CLST?, CAL_SHIFT?, CAL_SLST?, CAL_RPT?, ECHO?, EXPLAIN?, RPT_STR?, *OPT?, and *STATE? commands. Those strings include leading and trailing quotation marks. (See Table 5-2 for details.)

Input Buffer Operation

As the 5730A Calibrator receives each data byte from the controller, it places the bytes in a portion of memory called the input buffer. The input buffer holds up to 128 data bytes and operates in a first in, first out fashion.

The Calibrator treats the EOI IEEE-488 control line as a separate data byte and inserts it into the input buffer if it is encountered as part of a message terminator.

Input buffer operation is transparent to the program running on the controller. If the controller sends commands faster than the Calibrator can process them, the input buffer fills to capacity. When the input buffer is full, the Calibrator holds off the IEEE-488 bus with the NFRD (Not Ready For Data) handshake line. When the Calibrator has processed a data byte from the full input buffer, it then completes the handshake, allowing the controller to send another data byte.

The Calibrator clears the input buffer on power-up and on receiving the DCL (Device Clear) or SDC (Selected Device Clear) messages from the controller.

Under RS-232C serial port remote control that uses Control/S (XOFF) protocol, the Calibrator issues a Control/S (XOFF) when the input buffer becomes 80 % full. The Calibrator issues a Control/Q (XON) when it has read enough of the input buffer so that it is less than 40 % full. When RTS (Request to Send) protocol is used, the serial interface retracts and asserts RTS in response to same conditions as for XON/XOFF protocol.

Commands

Table 6-4 summarizes the commands by function. Table 6-5 provides protocol details of the remote commands. Table 6-6 provides protocol details of the three special commands available for serial remote control only. The commands duplicate almost all activities that can be initiated from the front panel in local operation. Separate headings for each command in the tables provide the parameters and responses (if any), and an example for cases in which the parameters are not self-explanatory.

Multiple Commands

Controllers may send commands all at once, or one at a time. To set the output to 100 mV dc and then place the 5730A Calibrator into operate, two separate commands may be used:

```
OUT 100 MV <CR/LF>
OPER <CR/LF>
```

Or enter it as a compound command on a single line:

```
OUT 100 MV; OPER <CR/LF>
```

Coupled Commands

When a compound command follows another command, there is a possibility that a fault can occur because of the action of the first command. Such commands are called coupled commands. An example of coupled commands that cause a fault is:

```
“OUT 1V, 1 MHZ”
```

followed by the compound command:

```
“OUT 100V”;OUT 100 HZ.”
```

The second command causes a fault because when the 5730A Calibrator encounters “OUT 100V”, it is interpreted as 100V, 1 MHz, which is out of range of the Calibrator. If only the second compound command was sent, there would have been no fault and the Calibrator would be set to 100 V at 100 Hz.

Another example is:

```
“OUT 1V ; RANGELCK ON”
```

followed by:

```
“OUT 10V ; RANGELCK OFF.”
```

In this case, when the Calibrator interprets the first half of the second command, it causes an error since the previous command locked the range on 2.2 V.

Any command that affects the state of the output is a coupled command, for example order-dependent. These commands include all the following: *RST, BOOST, BTYPE, CAL_CHK, CAL_REF, CAL_STORE, CAL_ZERO, CUR_POST, DIAG, EXTGUARD, EXTSENSE, FORMAT, INCR, LIMIT, MULT, NEWREF, OFFSET, OPER, OUT, PHASE, PHASELCK, PHASESFT, RANGELCK, RCOMP, REMOTE, LOCAL, LOCKOUT, SCALE, STBY, WBAND, CAL_RNG. Make sure to use appropriate sequences when these commands are used.

Sequential and Overlapped Commands

Commands executed immediately as they are encountered in the data stream are called sequential commands. Commands that begin execution, but are completed some time later are called overlapped commands, because they can be overlapped by later commands. Headings under each command description in Tables 6-5 and 6-6 define whether the command is sequential or overlapped. Because the 5730A Calibrator queues and executes overlapped commands in a multitasking way, *OPC, *OPC?, and *WAI are useful to detect completion of overlapped commands. (See the full descriptions of *OPC, *OPC?, and *WAI in Table 6-5 for more information.)

Commands Ignored When Not in Remote

The 5730A Calibrator can receive and execute most commands in either local or remote state. Commands that change the state of the Calibrator are prevented from executing unless the Calibrator is in the remote state. At the end of each command description in Tables 6-5 and 6-6 it is noted if the command is ignored if the Calibrator is not in the remote state. When the command description says, “ignored when not in remote,” it means that if sent to the Calibrator in the local state, the command will not work, and logs a fault into the fault queue. (Or it returns the fault message if in serial remote terminal mode.)

To put the Calibrator in remote, send the REMOTE command (described in Table 6-6) to the Calibrator. Refer to “Remote/Local State Transitions” for more information.

Commands that Require the Calibration Security Passcode

The subsequent commands do not work unless preceded by the CAL_SECURE OFF, <passcode>, CLOCK, CAL_STORE, CAL_RNG STORE, CAL_WBFLAT STORE, CAL_WBGAIN STORE, *PUD, and RPT_STR. Attempting to use any of these commands without doing so logs a fault into the fault queue. (Or it returns the fault message if in remote terminal mode.)

Long Term Commands

Remote commands that take a relatively long time to execute are identified as such in Table 6-5, which follows the command summary in Table 6-4. If a command that produces a change in 5730A Calibrator state (for example any “OPER” command) is received during the execution of a long-term command, for example, CAL_CHK, the command is ignored and a device-dependent fault occurs. (Bit 3 in the Event Status Register is set to 1 if enabled, and the fault code for the fault is available to be read from the fault queue. See the FAULT? and EXPLAIN? commands for more information.)

Definition: Queries and Commands

Messages directed to the 5730A Calibrator fall naturally into two categories: commands and queries. Commands instruct the Calibrator to do something or to set a value and no response is expected. Queries generally ask only for information from the Calibrator and a response is always expected. Some queries also require the Calibrator to take action. For example, the *TST? query has the Calibrator do a self test, then send the result to the controller. A query always ends with a question mark. A command never ends with a question mark. Tables 6-5 and 6-6 do not separate commands and queries. They are all called commands and are presented together in one alphabetical list.

All query responses are generated instantly on receipt of the query. Queries generate their output when the Calibrator executes the query rather than when the controller attempts to read the response. The Calibrator generates the requested message and places it in an area of memory called the output buffer. When the controller addresses the Calibrator as a talker, the contents of the output buffer are transmitted to the controller.

Some messages have both query and command forms (for example, *PUD and *PUD?). In such cases, the command generally sets the value of a parameter and the query generally returns the most recent value of the parameter. Some messages are queries only (for example, *IDN?). Some messages are commands only (for example, *RST).

Functional Elements of Commands

Table 6-1 lists the functional elements of commands described by the IEEE-488.2 standard that are used by the 5730A Calibrator. This table is for those who have a copy of the standard and want to use it to pursue additional information. The standard provides full definitions and syntax diagrams for each element.

Table 6-1. Functional Elements of Commands

Element	Function
PROGRAM MESSAGE	A sequence of zero or more PROGRAM MESSAGE UNIT elements, each of which is separated by a PROGRAM MESSAGE UNIT SEPARATOR element
PROGRAM MESSAGE UNIT	A command, programming data, or query received by the device.
COMMAND MESSAGE UNIT	A command or programming data received by the device.
QUERY MESSAGE UNIT	A query sent from the controller to the device.
PROGRAM DATA	Any of the six available program data types.
PROGRAM MESSAGE UNIT SEPARATOR	Separates the PROGRAM MESSAGE UNIT elements that comprise a PROGRAM MESSAGE.
PROGRAM HEADER SEPARATOR	Separates the header from the PROGRAM DATA.
PROGRAM DATA SEPARATOR	Separates PROGRAM DATA ELEMENTS listed under one header.
PROGRAM MESSAGE TERMINATOR	Terminates a PROGRAM MESSAGE.
COMMAND PROGRAM HEADER	Specifies a function or operation. Used with any associated PROGRAM DATA ELEMENTS.
QUERY PROGRAM HEADER	Similar to a COMMAND PROGRAM HEADER except that it contains a query indicator (?) since a response from the device is expected.
CHARACTER PROGRAM DATA	A data type suitable for sending short mnemonic data, generally used where a numeric data type is not suitable.
DECIMAL NUMERIC PROGRAM DATA	A data type suitable for sending decimal integers of decimal fractions, with or without exponents.
NON-DECIMAL NUMERIC PROGRAM DATA	A data type suitable for sending integer numeric representations in base 16, 8, or 2.
SUFFIX PROGRAM DATA	An optional field that follows DECIAML NUMERIC PROGRAM DATA, and is used to indicate associated multipliers and units.
STRING PROGRAM DATA	A data type suitable for sending 7-bit ASCII character strings where the content needs to be hidden (by delimiters).
ARBITRARY BLOCK PROGRAM DATA	A data type suitable for sending blocks of arbitrary 8-bit information. Block size is limited to 1024 bytes.

Interface Messages (IEEE-488 Only)

Interface messages manage traffic on the bus. Device addressing and clearing, data handshaking, and commands to place status bytes on the bus are all directed by interface messages. Some of the interface messages occur as state transitions of dedicated control lines. The rest of the interface messages are sent over the data lines with the ATN signal true. All device-dependent and common commands are sent over the data lines with the ATN signal false.

IEEE-488 standards define interface messages. Table 6-2 lists the interface messages that the 5730A Calibrator accepts. Table 6-3 lists the interface messages that the 5730A Calibrator sends. The mnemonics listed in the tables are not sent as literal statements as commands are. In this way they are different from device-dependent and common commands.

Interface messages are handled automatically in most cases. For example, handshake messages DAV, DAC, and RFD automatically occur under the direction of an instrument interface itself as each byte is sent over the bus.

Table 6-2. Interface Messages Accepted by the Calibrator

Mnemonic	Name	Function
ATN	Attention	A control line used to notify all instruments on the bus that the next data bytes are an interface message. If ATN is low, these data bytes are interpreted as device-dependent or common commands, addressed to a specific instrument.
DAC	Data Accepted	Sets the handshake signal line NDAC low.
DAV	Data Valid	Asserts the handshake signal line DAV.
DCL	Device Clear	Clears the input/output buffers.
END	End	A message that appears when the controller asserts the EOI signal line before sending a byte.
GTL	Go To Local	Transfers control of the Calibrator from one of the remote states to one of the local states (See Table 6-8.)
LLO	Local Lockout	Transfers remote/local control of the Calibrator. (See Table 6-8.)
IFC	Interface Clear	A control line that sets the interface to a quiescent state.
MLA	My Listen Address	Addresses a specific device on the bus as a listener. The controller sends MLA automatically whenever it directs a device-dependent or common query to a specific instrument.

Table 6-2. Interface Messages Accepted by the Calibrator (cont.)

Mnemonic	Name	Function
MTA	My Talk Address	Addresses a specific device on the bus as a talker. The controller sends MTA automatically whenever it directs a device-dependent or common query to a specific instrument.
REN	Remote Enable	Transfers remote/local control of the Calibrator. (See Table 6-8.)
RFD	Ready For Data	Set the handshake signal line NRFD low.
SDC	Selected Device Clear	Identical to DCL, but only operates when the Calibrator is addressed as a listener.
SPD	Serial Poll Disable	Cancels a Serial Poll Enable.
SPE	Serial Poll Enable	Causes the Calibrator to return a Status Byte to the next command that address it as a listener, no matter what the command is.
UNL	Unlisten	“Unaddresses” a specific device on the bus as a listener. The controller send UNL automatically after the device has successfully received a device-dependent or common command.
UNT	Untalk	“Unaddresses” a specific device on the bus as a talker. The controller sends UNT automatically after it receives the response from a device-dependent or common query.

Table 6-3. Interface Messages Sent by the Calibrator

Mnemonic	Name	Function
END	End	A message that appears when the Calibrator asserts the EOI control line, which happens when the Calibrator transmits the ASCII character LF for its termination sequence or terminator.
DAC	Data Accepted	Sets the handshake signal line NDAC low.
DAV	Data Valid	Asserts the handshake signal line DAV.
RFD	Ready For Data	Sets the handshake signal line NRFD low.
SRQ	Service Request	A control line that can be asserted by any device on the bus to indicate that it requires attention. For details, see “Check the Calibrator Status.”
STB	Status Byte	The response sent to a serial poll (SPE) by the Calibrator.

Use of *OPC?, *OPC, and *WAI

The *OPC?, *OPC, and *WAI commands are used to maintain control of the order of execution of commands that could otherwise be passed up by subsequent commands.

If an OUT command had been sent, check if the output has settled by sending the query *OPC?. As soon as the OUT command has completed (output settled), a 1 is shown in the output buffer. Always follow a *OPC? command with a read command. The read command causes program execution to pause until the addressed instrument responds.

The *OPC command is similar in operation to the *OPC? query, except that it sets bit 0 (OPC for “Operation Complete”) in the Event Status Register to 1 rather than sending a “1” to the output buffer. One simple use for *OPC is to include it in a program in order for it to generate an SRQ (Service Request). Then an SRQ handler written into the program can detect the operation complete condition and respond appropriately. *OPC can be used similarly to *OPC?, except the program must read the ESR to detect the completion of all operations.

The *WAI command causes the 5730A Calibrator to wait until any prior commands have been completed before continuing on to the next command, and takes no other action. *WAI is a convenient way to halt operation until the command or commands preceding it have completed.

Table 6-4. Command Summary by Function

Error Mode Commands	
ADJOUT?	Returns the adjusted output magnitude and frequency
ERR_REF	Selects the denominator for UUT error calculations.
ERR_REF?	Returns the denominator used to compute UUT error.
INCR	Increments or decrements the output
MULT	Multiplies the reference by a value and establishes a new reference
NEWREF	Establishes a new reference
OFFSET	Sets and enables or disables an offset
OFFSET?	Returns the value of the present offset
OLDREF	Sets the output to the present reference
OUT_ERR?	Returns the UUT error computed by the Calibrator
REFOUT?	Returns the value of the present reference
SCALE	Activates and deactivates scaling
SCALE?	Returns scaling information
SCAL_ERR?	Returns the value of the scale error if scaling is active
Calibrator Configuration Commands	
BRIGHTNESS	Sets the brightness of the GUI display.
BRIGHTNESS?	Returns the brightness setting.
BTYPE	Selects the amplifier type for voltage or current boost
BTYPE?	Returns the amplifier types set for voltage and current boost
CLOCK	Sets the clock/calendar
CLOCK?	Returns the setting of the clock/calendar
CUR_POST	Selects the active binding post for non-boosted current output
CUR_POST?	Returns the active binding post for non-boosted current output
EMULATE	Partially emulates a 5700A or 5720A over the remote interface.
EMULATE?	Returns the state of emulation as set by the EMULATE command.
EXTGUARD	Opens and closes an internal connection between GUARD and LO
EXTSENSE	Opens and closes an internal connection between SENSE and OUTPUT
FORMAT	Restores calibration constants and setups to factory defaults
LIMIT	Sets positive and negative output limits
LIMIT?	Returns the programmed positive and negative output limits
*LRN?	Returns a list of commands that would duplicate the present state
RANGE?	Returns the present output range
RANGELCK	Locks in the present range, or selects autoranging
LCOMP_52120	Sets inductance compensation for attached 52120As
POST_52120	Sets the output terminals for attached 52120As
XFERCHOICE	Sets whether the choice to turn ac/dc transfers off is given on the front panel GUI for ac V outputs.
XFERCHOICE?	Returns whether the choice to turn ac/dc transfers off is given on the front panel GUI for ac V outputs.

Table 6-4. Command Summary by Function (cont.)

Output Commands	
BOOST	Activates or deactivates an auxiliary amplifier
DBMOUT?	Returns the output amplitude and frequency, but in dBm if ac V
OPER	Activates the Calibrator output if it is in standby
OUT	Sets the output and establishes a new reference for error mode
OUT?	Returns the output amplitude and frequency
PHASE	Sets the phase shift of the phase output signal
PHASE?	Returns the phase shift of the phase output signal
PHASELCK	Activates or deactivates phase locking to an external signal
PHASESFT	Activates or deactivates variable phase output
RCOMP	Activates or deactivates two-wire compensation circuitry
STBY	Puts the Calibrator in standby
VOUT?	Returns the output amplitude in volts if the active units are dBm
WBAND	Activates or deactivates the Wideband AC Module (Option 5730A/03 or 5730A/05)
XFER	Turns ac/dc transfers off (or on) after output has settled.
XFER?	Returns whether ac/dc transfers after settling are turned on.
Overall Functions	
*CLS	Clear- clears status registers, any service request, and flags
ECHO?	Echoes a string to the remote port
*OPC	Sets bit 0 in the ESR to 1 when pending remote operations are complete
*OPC?	Returns a "1" when all pending remote operations are complete
*PUD	Stores a string of user-selected characters in nonvolatile memory
*PUD?	Returns the contents of the PUD memory
RPT_STR	Loads the user report string
RPT_STR?	Returns the user report string
*RST	Reset-sets the Calibrator to its default power-up state
*WAI	Halts remote program execution until all pending remote operations are complete

Table 6-4. Command Summary by Function (cont.)

Remote Interface Parameter Setting Commands	
SP_EOF	Sets the End-Of-File (EOF) string
SP_EOF?	Returns the End-Of-File (EOF) string
SP_SET	Sets baud, terminal or computer mode, stall method, data bits, stop bits, parity, and End-Of-Line (EOL) string
SP_SET?	Returns baud rate, terminal or computer mode, stall method, data bits, stop bits, parity, and End-Of-Line (EOL) string
ADDR	Set GPIB address
ADDR?	Returns the GPIB address
DHCP	Turns on/off DHCP
DHCP?	Returns the state of the DHCP setting
ENETPORT	Sets Ethernet port
ENETPORT?	Returns the Ethernet port setting.
EOL	Sets EOL for given port
EOL?	Gets EOL for given port
GWADDR	Sets gateway address
GWADDR?	Returns the gateway address.
IPADDR	Sets IP address
IPADDR?	Returns the IP address
MACADDR?	Gets MAC address
REM_MODE	Sets computer/terminal mode for given port
REM_MODE?	Gets computer/terminal mode for given port
SUBNETMASK	Sets subnet mask
SUBNETMASK?	Returns the subnet mask

Table 6-4. Command Summary by Function (cont.)

Calibration, Testing, and Diagnostics Commands for the Calibrator	
CAL_ADJ	Does the internal portion of calibration
CAL_CHK	Starts calibration check
CAL_CLST?	Returns a group of calibration constant names and their values
CAL_CONF	Sets the calibration specifications to a confidence level of either 95 % or 99 %
CAL_CONF?	Returns the current calibration confidence level
CAL_CONST?	Returns the value of a particular constant
CAL_COUNT?	Number of times the Calibrator has been unsecured
CAL_DATE?	Returns the date of the most recent calibration
CAL_DAYS?	Returns the days elapsed since last calibration recall
CAL_INTV	Sets the calibration interval
CAL_INTV?	Returns the calibration interval
CAL_PASSWD	Change the calibration passcode
CAL_REF	Does a calibration procedure with a 1 Ω , 10 k Ω , or 10 V standard
CAL_RCSV?	Returns a comma-separated-value format report similar to what is saved on a USB flash drive
CAL_RNG	Starts a self-calibration procedure of a range
CAL_RPT?	Returns a formatted calibration report
CAL_SECURE	Locks/unlocks calibration security
CAL_SECURE?	Gets lock state of calibration security
CAL_SHIFT?	Returns the shift of a range due to a calibration action
CAL_SLST?	Returns the shifts of a group of ranges
CAL_STORE	Stores new calibration constants in nonvolatile memory
CAL_TEMP	Sets the temperature for calibration
CAL_TEMP?	Returns the calibration temperature last specified
CAL_USB	Saves the calibration report to a USB flash drive
CAL_WBFLAT	Does Wideband AC Module (Option 5730A/03 or 5730A/05) flatness calibration
CAL_WBGAIN	Does Wideband AC Module (Option 5730A/03 or 5730A/05) gain calibration
CAL_ZERO	Does internal zeros calibration
DIAG	Runs self-diagnostics

Table 6-4. Command Summary by Function (cont.)

Calibration, Testing, and Diagnostics Commands for the Calibrator (cont.)	
DIAGFLT	Sets the Calibrator response to faults in remote diagnostics
DIAGFLT?	Returns the Calibrator response to faults in remote diagnostics
OHMSREF?	Returned calculated resistance reference (Main software revision H and after)
*TST?	Checks the nonvolatile storage area (calibration constants and instrument settings).
Serial/USB/Ethernet Only Remote Commands	
LOCAL	Puts the Calibrator into the local state
LOCKOUT	Puts the Calibrator into the local lockout state
REMOTE	Puts the Calibrator into remote state
Status Commands	
*ESE	Loads the Event Status Enable register
*ESE?	Reads the Event Status Enable register
*ESR?	Reads and clears the Event Status Register
EXPLAIN	Decodes a fault code by returning a brief description
FAULT?	Returns the most recent fault code from the fault queue
*IDN?	Returns Calibrator identification information
ID52120?	Returns the number of 52120s connected and their serial numbers
ISCE	Loads the Instrument Status Change Enable register
ISCE?	Reads the Instrument Status Change Enable register
ISCR?	Reads and clears the Instrument Status Change Register
ISR?	Reads and clears the Instrument Status Register
ONTIME?	Returns the number of minutes since power-up this session
*OPT?	Returns a list of installed modules and attached amplifiers
*SRE	Loads the Service Request Enable register
*SRE?	Reads the Service Request Enable register
STATE?	Returns the long-term state of the Calibrator
*STB?	Returns the status byte
UNCERT?	Returns the calculated absolute uncertainty of the output

Table 6-5. Commands

ADDR	
Description	Sequential command. Ignored if not in remote. Sets the GPIB interface bus address.
Parameter	Bus address
Example	ADDR 4 Sets the GPIB interface bus address to 4
ADDR ?	
Description	Sequential command. Gets the GPIB interface bus address.
Parameter	None
Response	Integer
Example	ADDR? Returns 4 if the gpib interface bus address is set to 4
ADJOUT?	
Description	Sequential Command. Returns the adjusted output magnitude and frequency. The adjusted output magnitude is the output after modification by the front panel knob or the INCR remote command. In all output functions but resistance, ADJOUT? behaves exactly like OUT?. In the resistance function, OUT? returns the actual Calibrator output, which cannot be adjusted, and ADJOUT? returns what would be the reading on the Display in direct operation. The frequency is always the present output frequency.
Parameter	None
Response	(Float) Output amplitude (String) Units (V, DBM, A, or OHM) (Float) Frequency (0 if dc or ohms)
Example	1.256983E+01,V,0 (12.56983V) 1.883E-01,A,4.42E+02 (188.3 mA, 442 Hz) 1.9E+06,OHM,0 (1.9 MΩ)
BOOST	
Description	Overlapped Command, ignored if not in remote. Activates and deactivates an accessory amplifier.
Parameter	ON Activates the appropriate amplifier for the type of output) OFF Deactivates the active amplifier
Example	BOOST ON Activates the appropriate amplifier if the last OUT command selected an output supported by the attached amplifier.

Table 6-5. Commands (cont.)

BRIGHTNESS	
Description	Sets the brightness of the GUI display.
Parameter	Integer, 0 to 100, where 0 is dimmest and 100 is brightest.
Example	BRIGHTNESS 50 Sets the display to half brightness (the default value).
BRIGHTNESS?	
Description	Returns the brightness setting.
BTYPE	
Description	Sequential command, ignored if not in remote. Selects the accessory amplifiers for current and voltage boost. If the BOOST command is active when BTYPE is received, BTYPE does not take effect until the next time the BOOST command is received. The setting of BTYPE remains even after the power is turned off.
Parameter	One of the subsequent: VB5725 (Selects the 5725A for voltage boost) IB5725 (Selects the 5725A for current boost) IB52120 (Selects the 52120A for current boost)
Example	BTYPE IB5725 Selects Model 5725A as the current amplifier.
BTYPE?	
Description	Sequential command. Returns the model numbers of auxiliary amplifiers selected for voltage and current boost. Returns IB52120 if Model 52120A is selected for current boost.
Parameter	None
Response	(String, string) VB<model number>,IB<model number>; VBNONE is also available to prevent the Calibrator from automatically switching to a connected 5725A.
Example	BTYPE? Returns: "VB5725,IB5725" if Model 5725A is selected for voltage boost and Model 5725A is selected for current boost.
CAL_ADJ	
Description	Overlapped long-term command, ignored if not in remote. Does the internal calibration. This command should be sent after the last CAL_REF command in the sequence of calibration. (See CAL_REF for an example.)
Parameter	None
CAL_CHK	
Description	Overlapped long-term command, ignored if not in remote. Starts calibration check. Results are available via the CAL_SLST? or CAL_SHIFT? commands.
Parameter	None

Table 6-5. Commands (cont.)

CAL_CLST?	
Description	Sequential command. Returns a list of names values of a particular group of calibration constants.
Parameter	CAL (Returns active calibration constants) CHECK (Returns calibration check constants) PREV (Returns previous calibration constants)
Response	(String) "<EOL> <total number of constants> <EOL> <name> <value> <EOL> <name> <value> <EOL> (cont) "
Example	CAL_CLST?, CAL Could return: " 424 D3P, 3.9817876E+02 (Continues for about 400 pairs of names and values.) "
CAL_CONF	
Description	Sequential command. Sets the calibration specifications to a confidence level of either 99% or 95%.
Parameter	CONF95 or CONF99: Sets 95% or 99% specifications.
CAL_CONF?	
Description	Sequential command. Returns the current calibration confidence level.
Parameter	None
Response	CONF95 (indicates 95% specifications) or CONF99 (indicates 99% specifications)
CAL_CONST?	
Description	Sequential command. Returns the value of a particular calibration constant from a particular group of constants.
Parameter	1. CAL (From active calibration constants) CHECK (From calibration check constants) PREV (From previous calibration constants) 2. Symbolic name of the calibration constant desired (see Appendix D).
Response	(Float) The value of the constant
Example	CAL_CONST? CHECK, KV6 Could return: 6.5000010E+00
CAL_COUNT?	
Description	Sequential command. Returns the number of calibration constants that have been saved at the end of a calibration procedure (except for DC Zeros)
Response	integer
Parameter	None
Example	CAL_COUNT? Returns 34 if calibration constants have been saved 34 times.

Table 6-5. Commands (cont.)

CAL_DATE?	
Description	Sequential command. Returns the date of the most recent calibration of the specified type.
Parameter	B5725 (Last 5725A Amplifier calibration) CAL (Last calibration of the Calibrator) WBFLAT (Last wideband flatness calibration) WBGAIN (Last wideband gain calibration) ZERO (Last dc V zero calibration)
Response	(Integer) Date as MMDDYY, DDMMYY, or YYMMDD depending on the setting of DATEFMT.
CAL_DAYS?	
Description	Sequential command. Returns the number of days elapsed since the last calibration activity of the specified type.
Parameter	B5725 (Last 5725A Amplifier calibration) CAL (Last calibration of the Calibrator) WBFLAT (Last wideband flatness calibration) WBGAIN (Last wideband gain calibration) ZERO (Last dc V zero calibration)
Response	(Integer) Number of elapsed days
CAL_INTV	
Description	Sequential command, ignored if not in remote. Sets the calibration interval for main output calibration. This value is saved in nonvolatile memory and used for calculating the Calibrator output uncertainty.
Parameter	1, 90, 180, or 365- the number of days in the calibration cycle.
CAL_INTV?	
Description	Sequential command. Returns the calibration interval for main output calibration.
Parameter	None
Response	(Integer) 1, 90, 180, or 365- the number of days in the calibration cycle.
CAL_PASSWD	
Description	Sequential command. Ignored if not in remote. Sets security password. The Calibrator secure state must be set to off or an execution fault results.
Parameter	1. current security passcode (quoted string consisting of up to 8 decimal digits). 2. new security passcode (quoted string consisting of up to 8 decimal digits).
Example	CAL_PASSWD "5730", "12345" Sets the security passcode to 12345.

Table 6-5. Commands (cont.)

CAL_REF	
Description	<p>Overlapped long-term command, ignored if not in remote.</p> <p>Calibrates the internal references for the main output functions based on comparison to an externally-applied standard. To calibrate the Calibrator, the controller must send a CAL_TEMP command, a sequence of CAL_REF commands (one for each external standard), followed by a CAL_ADJ command, then a CAL_STORE command. These commands must be in the same sequence as in the example. Note that the CAL_STORE command requires the security passcode. To only collect performance data, use this command without a CAL_STORE.</p>
Parameter	The value of the external standard attached to the Calibrator binding posts. The value and units of the parameter tell the Calibrator which calibration procedure to do.
Example	<pre> CAL_TEMP 23.5 CAL_REF 10.00013 V ; *WAI CAL_REF -10.00013 V ; *WAI CAL_REF 9.99987 KOHM ; *WAI CAL_REF 1.00026 OHM ; WAI CAL_ADJ CAL_SECURE OFF, <passcode> CAL_STORE *WAI CAL_SECURE ON </pre>
CAL_RNG	
Description	<p>Overlapped command, ignored if not in remote.</p> <p>Starts a calibration of a range. This command causes the Calibrator to source the calibration magnitude specified by the second parameter for the range specified by the first parameter. To calibrate a range, the controller must send commands in the same sequence as in the example.</p>
Parameter	<ol style="list-style-type: none"> 1. The range identifier of the range to calibrate from Table 5-4, or the keyword NULL or STORE. 2. (Only if parameter 1 is the range mnemonic) The calibration magnitude for the Calibrator to source. Must be 45% to 95% of the range specified. 3. (Optional; only if parameter 1 is the range mnemonic) The frequency of the Calibrator output with optional multiplier and units.
Example	<pre> CAL_TEMP 23.5 CAL_RNG DC2_2V, 2V ; OPER ; *WAI INCR (enough to null the Calibrator) CAL_RNG NULL CAL_RNG STORE </pre>

Table 6-5. Commands (cont.)

CAL_RPT?	
Description	Sequential command. Returns a report for a specified calibration activity (see Chapter 6 for format details).
Parameter	CAL (Output change report for calibration) CHECK (Output change report for calibration check) RAW (A list of all calibration constants)
Response	(String) "<EOL> <formatted report> "
CAL_RCSV?	
Description	Sequential command. Returns a report in CSV format for a specified calibration activity (see Chapter 6 for format details).
Parameter	CAL (Output change report for calibration) CHECK (Output change report for calibration check) RAW (A list of all calibration constants)
Response	(String) "<EOL> <formatted report> "
CAL_SECURE	
Description	Sequential command. Ignored if not in remote. Lock/unlocks the calibration security by use of a passcode. The passcode is entered as a quoted string of decimal digits. (eg "12345"). To secure the Calibrator, no passcode is necessary. If an incorrect password is entered, the Calibrator will automatically be resecured if it was unsecured.
Parameter	1. ON/OFF 2. <passcode>
Example	CAL_SECURE OFF, "12345" Unsecures the Calibrator.
Example	CAL_SECURE ON Secures the Calibrator.
CAL_SECURE?	
Description	Sequential command. Returns the current security state of the Calibrator.
Parameter	None
Response	String
Example	CAL_SECURE? Returns ON if the Calibrator is secured.

Table 6-5. Commands (cont.)

CAL_SHIFT?	
Description	Sequential command. Returns a particular set of output shifts from a particular range.
Parameter	CAL (Output changes due to calibration check) CHECK (All output changes due to calibration check) Range identifier from Table 5-4
Response	(String) "<EOL> range name>,<# points><EOL> <mag 1>,<freq 1>,<offset 1>,<ashift 1>,<rshift 1><sshift 1>,<spec 1><EOL> ... <mag n>,<freq n>,<offset n>,<ashift n>,<rshift n>,<sshift n>,<spec n><EOL> " Where: <range name> = Range identifier from Table 5-4 <# points> = (Integer) Number of points for the range <mag n> = (Float) Magnitude for point n in range units <freq n> = (Float) Frequency for point n in Hz <offset n> = (Float) Zero shift for point n in range units <ashift n> = (Float) Absolute shift for point n in range units <rshift n> = (Float) Relative shift for point n (ppm) <sshift n> = (Float) % of spec shift for point n <spec n> = Calibrator specification for point n in ppm Range units are the appropriate units for the range, for example, for all DC V ranges, range units are V.
Example	CAL_SHIFT? CAL, DC220MV could return: " DC220MV,2 2.20E-1,0.00E+00,1.76E-07,1.97E-07,8.98E-01,7.10E+00,1.26E+01 -2.20E-1,0.00E+00,1.58E-07,1.38E-07,6.26E-01,4.95E+00,1.26E+01 "

Table 6-5. Commands (cont.)

CAL_SLST?	
Description	Sequential command. Returns a group of calibration constant shifts due to a calibration activity.
Parameter	CAL (All output changes due to calibration) CHECK (All output changes due to calibration check)
Response	<p>(String) "<EOL> <range name>,<# points><EOL> <mag 1>,<freq 1>,<offset 1>,<ashift 1>,<rshift 1><sshift 1>,<spec 1><EOL> ... <mag n>,<freq n>,<offset n>,<ashift n>,<rshift 1>,<sshift n>,<spec n><EOL> "</p> <p>Where:</p> <p style="padding-left: 40px;"><range name> = Range identifier from Table 5-4 <# points> = (Integer) Number of points for the range <mag n> = (Float) Magnitude for point n in range units <freq n> = (Float) Frequency for point n in Hz <offset n> = (Float) Zero shift for point n in range units <ashift n> = (Float) Absolute shift for point n in range units <rshift n> = (Float) Relative shift for point n (ppm) <sshift n> = (Float) % of spec shift for point n <spec n> = Calibrator specification for point n in ppm</p> <p>Range units are the appropriate units for the range, for example, for all DC V ranges, range units are V.</p>
Example	<p>CAL_SLST? CAL could return: " 49 DC220MV,2 2.20E-1,0.00E+00,1.76E-07,1.97E-07,8.98E-01,7.10E+00,1.26E+01 -2.20E-1,0.00E+00,1.58E-07,1.38E-07,6.26E-01,4.95E+00,1.26E+01 DC2_2V,2 (cont) "</p>
CAL_STORE	
Description	Sequential command, ignored if not in remote. Stores all new calibration constants in nonvolatile memory. Use this command to save the results of a CAL_ADJ command after completely finished with calibration via remote control. The Calibrator secure state must be set to off or an execution fault results.
Parameter	None

Table 6-5. Commands (cont.)

CAL_TEMP	
Description	Sequential command, ignored if not in remote. Sets the temperature for calibration. This should be done before sending CAL_REF, CAL_WBFLAT, CAL_WBGAIN, or CAL_CHK commands. Once set, the temperature is used for all calibration activities until it is changed. If the temperature is not set before a calibration activity, the Calibrator uses a default of 23.0 °C.
Parameter	Temperature in degrees C.
CAL_TEMP?	
Description	Sequential command. Returns the previous ambient temperature setting used for a particular calibration procedure.
Parameter	B5725, CAL, WBFLAT, WBGAIN, or CHECK
Response	(Float) Temperature in degrees C.
CAL_USB	
Description	Overlapped command. Saves a calibration report to a USB thumb drive connected to the front panel USB host port.
Parameter	CAL (Output change report for calibration) CHECK (Output change report for calibration check) RAW (A list of all calibration constants)
Example	CAL_USB RAW
CAL_WBFLAT	
Description	Overlapped command, ignored if not in remote. Does Wideband AC Module (Option 5730/03 or 5730A/05) flatness calibration. There are two different calibration procedures for the wideband module- gain and flatness. Wideband gain is to be done at every calibration cycle. Wideband flatness is needed only during full verification, recommended every two years. For reference, the manual procedure for wideband flatness calibration is in Chapter 7. After sending a CAL_WBFLAT START command, the controller must adjust the Calibrator output with the INCR command until it matches the calibration voltage, then inform the Calibrator of the fact by sending a CAL_WBFLAT NULL command. A series of points to test is selected automatically by the software. After each CAL_WBFLAT NULL command, determine the calibration setting by sending an OUT? command.
Parameter	START (Starts flatness calibration, sources the first point) NULL (Calculates flatness constant, sources the next point) STORE (Stores wideband flatness constants into non-volatile memory)
Example	CAL_TEMP 24.6 CAL_WBFLAT START (Connect to external standard as in Chapter 7) OPER INCR (Enough to get the Calibrator output correct) CAL_WBFLAT NULL (Repeat the preceding two commands for each calibration point. CAL_NULL automatically sources the next calibration point. When OUT? returns 0,V,0, all points have been calibrated.) CAL_WBFLAT STORE

Table 6-5. Commands (cont.)

CAL_WBGAIN	
Description	<p>Overlapped long-term command, ignored if not in remote.</p> <p>Does Wideband AC Module (Option 5730/03 or 5730A/05) gain calibration. There are two different calibration procedures for the wideband module: gain and flatness. Wideband gain is to be done at every calibration cycle. Wideband flatness is needed only during full verification (recommended every two years). For reference, the manual procedure for wideband gain calibration is in Chapter 7.</p> <p>To calibrate wideband gain in remote, the wideband output cable must be connected to the Calibrator SENSE binding posts as described in Chapter 7, then the controller must send commands in the same sequence as in the example. For positive gain, the center conductor is connected to SENSE HI. For negative gain, the center conductor is connected to SENSE LO.</p>
Parameter	<p>PGAIN (Calibrates wideband positive gain)</p> <p>NGAIN (Calibrates wideband negative gain)</p> <p>STORE (Stores wideband constants into non-volatile memory)</p>
Example	<p>CAL_TEMP 23.5</p> <p>CAL_WBGAIN PGAIN (Calibrates positive gain)</p> <p>(Reverse the SENSE connection now)</p> <p>CAL_WBGAIN NGAIN (Calibrates negative gain)</p> <p>CAL_WBGAIN STORE</p>
CAL_ZERO	
Description	<p>Overlapped long-term command, ignored if not in remote.</p> <p>Does internal zeros calibration. This removes offsets on the 2.2V dc range. It takes about 2-1/2 minutes, plus 30 seconds if teamed with 5725A, and does not require a change to the Calibrator security state.</p>
Parameter	None
CLOCK	
Description	<p>Sequential command, ignored if not in remote.</p> <p>Sets the clock/calendar. The Calibrator security state must be set to off or an execution fault results.</p>
Parameter	<ol style="list-style-type: none"> 1. Time in 24-hour format as HHMMSS 2. Date as MMDDYY, DDMMYY, or YYMMDD depending on the setting the DATEFMT.
Example	<p>CLOCK 133700, 071712 (Sets the clock/calendar to 1:37 p.m., July 17, 2012.)</p> <p>CLOCK 080000, 101012 (Sets the clock/calendar to 8:00 a.m., October 10, 2012.)</p>
CLOCK?	
Description	<p>Sequential command.</p> <p>Returns the setting of the clock/calendar.</p>
Parameter	None
Response	<ol style="list-style-type: none"> 1. (Integer) Time in 24-hour format as HHMMSS. 2. (Integer) Date as MMDDYY, DDMMYY, or YYMMDD depending on the setting of DATEFMT.
Example	<p>CLOCK?</p> <p>Returns:</p> <p>"150000,090112" if the clock/calendar is set to 3 p.m., September 1, 2012.</p>

Table 6-5. Commands (cont.)

*CLS	
Description	Sequential command. (Clear status.) Clears the ESR, ISCR, the fault queue, and the RQS bit in the status byte. This command terminates pending operation complete commands (*OPC or *OPC?).
Parameter	None
CUR_POST	
Description	Sequential command, ignored if not in remote. Selects the binding posts non-boosted current output. Once set, the Calibrator retains the current post setting during power-off periods.
Parameter	NORMAL (Selects the OUTPUT HI binding post) AUX (Selects the AUX CURRENT OUTPUT binding post) IB5725 (Selects binding posts on the 5725A)
CUR_POST?	
Description	Sequential command. Returns the binding posts for non-boosted current output.
Parameter	None
Response	(String) NORMAL (The OUTPUT HI binding post is selected) AUX (The AUX CURRENT OUTPUT binding post is selected) IB5725 (The 5725A binding posts are selected)
DATEFMT	
Description	Determine the format for clock/calendar front panel date display and entry, for entering and reading the date remotely with the CLOCK and CLOCK? commands, and for displaying calibration dates on the front panel and in calibration reports.
Parameter	MDY (Display: MM/DD/YY, remote and front panel entry: MMDDYY) DMY (Display: DD.MM.YY, remote and front panel entry: DDMMYY) YMD (Display: YYMMDD, remote and front panel entry: YYMMDD)
DATEFMT?	
Description	Returns the date format setting (see DATEFMT for its applications).
Parameter	None
Response	(String) MDY (Display: MM/DD/YY, date entry: MMDDYY), DMY (Display: DD.MM.YY, date entry: DDMMYY), or YMD (Display: YYMMDD, date entry: YYMMDD)
DBMOUT?	
Description	Sequential command. Same as OUT? except that if output is ac V, the returned magnitude is converted to dBm for the appropriate load (50Ω for wideband, 600 Ω standard ac V).
Parameter	None
Response	(Float) Output value (String) Units (DBM, V, A, or OHM) (Float) Frequency (0 if dc or ohms)
Example	1.256983E+01,V,0 (12.56983 V) +2.4203670E+01,DBM,4.4200E+02 1.9E+06,OHM,0 (1.9 MΩ)

Table 6-5. Commands (cont.)

DHCP	
Description	Sequential command. Ignored if not in remote. Enables/disables DHCP (Dynamic Host Configuration Protocol) for LAN operation.
Parameter	ON (enables DHCP operation) OFF (disables DHCP operation)
DHCP?	
Description	Sequential command. Returns the current state of the DHCP configuration.
Parameter	None
Response	String
Example	DHCP? Returns ON if DHCP is enabled.
DIAG	
Description	Overlapped long-term command, ignored if not in remote. Runs a self-diagnostics routine. If any faults are detected, they are logged into the fault queue where they can be read by the FAULT? query. The response to faults that occur during remote-controlled diagnostics depends by the setting of the DIAGFLT command.
Parameter	ALL (Runs all diagnostics routines) D5700 (Runs all Calibrator diagnostics) DV5725 (Runs 5725A voltage diagnostics) DI5725 (Runs 5725A current diagnostics) CONT (Continues execution of diagnostics) ABORT (Terminates execution of diagnostics)
DIAGFLT	
Description	Sequential command, ignored if not in remote. Determines the response to faults that occur during remote-controlled diagnostics. In all cases the fault encountered is logged into the fault queue before the Calibrator takes any action as set by this command. The settings of this command are saved in nonvolatile memory. The default is ABORT.
Parameter	HALT (Halts and waits for DIAG CONT or DIAG ABORT) ABORT (Terminates diagnostics) CONT (Diagnostics continues to completion, logging any more faults as encountered)
DIAGFLT?	
Description	Sequential command. Returns the setting of DIAGFLT.
Parameter	None
Response	(String) HALT, ABORT, or CONT
ECHO?	
Description	Sequential command. Echoes a string back to the remote interface port. Upper or lower case remains intact in this command.
Parameter	Any string
Response	(String including delimiting quotation marks)
Example	ECHO "123abc456" Returns: "123abc456"

Table 6-5. Commands (cont.)

EMULATE	
Description	Partially emulates a 5700A or 5720A over the remote interface. This changes the model number in the *IDN? response. It also accepts BTYPE VB5205 and implements it as if BTYPE VBNONE was sent, as a Fluke 5205A cannot be connected to the 5730A Calibrator.
Parameter	(Integer) 5700 selects 5700A emulation; 5720 selects 5720A emulation; anything else selects normal 5730A behavior.
Example	EMULATE 5720 Sets 5720A emulation.
EMULATE?	
Description	Returns the state of emulation as set by the EMULATE command.
Parameter	None
Response	(Integer) 5700 for 5700A emulation, 5720 for 5720A emulation, 0 for normal behavior.
ENETPORT	
Description	Sequential command. Ignored if not in remote. Sets the Ethernet port number.
Parameter	Port number
Example	ENETPORT 3490 Sets the Ethernet port number to 3490.
ENETPORT?	
Description	Sequential command. Returns the Ethernet port number.
Parameter	None
Response	Integer
Example	ENETPORT? Returns 3490 if the Ethernet port number is set to 3490
EOL	
Description	Sequential command. Ignored if not in remote. Sets the end of line terminator for outgoing data for a specified remote port.
Parameter	1. SERIAL, USB, ENET 2. CRLF, CR, LF
Example	EOL ENET, CR Sets the end of line terminator for Ethernet communication to CR.

Table 6-5. Commands (cont.)

EOL?	
Description	Sequential command. Returns the end of line terminator for outgoing data for a specified remote port.
Parameter	1. SERIAL, USB, ENET
Response	String
Example	EOL? SERIAL Returns CRLF if the serial end of line terminator is set to CRLF.
ERR_REF	
Description	Selects the denominator for UUT error calculations.
Parameter	NOMINAL to use the original reference, TRUVAL to use the edited value.
Example	ERR_REF TRUVAL
ERR_REF?	
Description	Selects the denominator for UUT error calculations.
Parameter	None
Example	ERR_REF? Returns TRUVAL if the edited value is the denominator.
*ESE	
Description	Sequential command. Loads a byte into the Event Status Enable Register, described under "Check the Calibrator Status."
Parameter	The decimal equivalent of the binary number to load into the register (0-255 only).
Example	*ESE 140 Enables bits 2 (QYE), 3 (DDE), and 7 (PON), and disables all the other bits. (See "Check the Calibrator Status" for details.)
*ESE?	
Description	Sequential command. Returns the byte from the Event Status Enable register, described under "Check the Calibrator Status."
Parameter	None
Response	(Integer) Decimal equivalent of the register byte.
Example	*ESE? Returns: "140" if bits 2 (QYE), 3 (DDE), and 7 (PON) are enabled (1) and the rest of the bits are disabled (0). (See "Check the Calibrator Status" for details.)

Table 6-5. Commands (cont.)

*ESR?	
Description	Sequential command. Returns the byte from the Event Status Register and clears the register. The ESR is described under "Check the Calibrator Status."
Parameter	None
Response	(Integer) Decimal equivalent of the register byte.
Example	*ESR? Returns: "140" if bits 2 (QYE), 3 (DDE), and 7 (PON) are set (1) and the rest of the bits are reset (0). (See "Check the Calibrator Status" for details.)
EXPLAIN?	
Description	Sequential command. Explains a fault code. This command returns a string that explains the fault code furnished as the parameter. The fault code (same as the parameter) is originally obtained by sending the FAULT? query.
Parameter	The fault code (an integer).
Response	(String) An explanation of the fault code.
Example	EXPLAIN? 224 Returns: Output Tripped To Standby
EXTGUARD	
Description	Overlapped command, ignored if not in remote. Sets the Calibrator to internal or external guard. (The same as pushing EX GRD in local operation.) The default is internal guard.
Parameter	ON (Sets the Calibrator to external guard) OFF (Sets the Calibrator to internal guard)
EXTSENSE	
Description	Overlapped command, ignored if not in remote. Selects internal or external sensing. (The same as pushing EX SNS in local operation.) The default is internal sensing.
Parameter	ON (Sets the Calibrator to external sensing) OFF (Sets the Calibrator to internal sensing)
FAULT?	
Description	Sequential command. Returns the earliest fault code contained in the Calibrator fault queue. After the fault code is received, use the EXPLAIN? command to find out the meaning of the fault code. A table of fault codes is also included in Appendix A of this manual. A zero value is returned if there are no faults, so to read the entire contents of the fault queue, repeat FAULT? until the response is "0."
Parameter	None
Response	(Integer) The fault code

Table 6-5. Commands (cont.)

FORMAT	
Description	Sequential command, ignored if not in remote. Use with extreme care. Restores the contents of the non-volatile memory to factory defaults. The non-volatile memory holds calibration constants and setup parameters. All calibration data is lost permanently. The Calibrator security state must be set to OFF: or an execution fault occurs.
Parameter	ALL (Replaces the whole contents with defaults) B5725 (Replaces 5725A calibration constants with defaults) CAL (Replaces all calibration constants with defaults) RNG (Replaces range calibration constants with defaults) SETUP(Replaces setup parameters with defaults)
GWADDR	
Description	Sequential command. Ignored if not in remote. Sets Ethernet gateway address for LAN communication when NOT in DHCP mode.
Parameter	Gateway address (quoted string consisting of 4 decimal values bound between 0-255 separated by periods).
Example	GWADDR "129.196.136.1" Sets the Etherent gateway address to 129.196.136.1
GWADDR?	
Description	Sequential command. Returns Ethernet gateway address for LAN communication when NOT in DHCP mode. When in DHCP mode, the response will be default.
Parameter	None
Response	String
Example	GWADDR? Returns 129.196.136.1 if the gateway address is set to 129.196.136.1 and DHCP is not enabled. Returns default if DHCP is enabled.
ID52120? (returns the number of 52120s connected and their serial numbers)	
Description	Sequential command. Returns the number of 52120s connected and their serial numbers.
Parameter	None
Response	One or more integers
Example	ID52120? Returns 0 if no 52120As are connected. Returns 2, 7346432, 8883213 if two 52120A's are connected with the indicated serial numbers.

Table 6-5. Commands (cont.)

*IDN?	
Description	Sequential command. Returns Calibrator model number and firmware version letters for the main, inguard, and if attached, the 5725A Amplifier CPU.
Parameter	None
Response	(String, string, 0, string) A message containing four fields separated by commas, as follows: Fluke 5730A Serial number Three firmware versions: one each for the Main CPU, the Inguard CPU, and the Boost CPU. Each version is separated by a plus (+). If no amplifier is attached then its position (third character) contains an asterisk (*).
Example	FLUKE,5730A,5248000,1.0+B+*
INCR	
Description	Overlapped command, ignored if not in remote. Increments the output amplitude and enters error mode, the same as with the output adjustment knob in local operation.
Parameter	Increment step size, positive for incremental step, negative for decremental step. Units (optional) specify magnitude or frequency.
Example	INCR -.00001 Enters error mode and decrements the output by .00001. INCR 1 Hz Enters error mode and increments the frequency by 1 Hz.
IPADDR	
Description	Sequential command. Ignored if not in remote. Sets IP address for LAN communication when NOT in DHCP mode and with static IP addressing.
Parameter	IP address (quoted string consisting of 4 decimal values bound between 0-255 separated by periods).
Example	IPADDR "129.196.136.119" Sets the Ethernet IP static address to 129.196.136.119
IPADDR ?	
Description	Sequential command. Returns IP address for LAN communication. When DHCP is enabled, this address will be the address allocated by the DNS server. When DHCP is disabled, this address will be the entered value of the static IP address.
Parameter	None
Response	String
Example	IPADDR? May return 129.196.137.45 if DHCP is enabled and the DNS server has allocated the device this address or 129.196.136.119 and DHCP is disabled and the static address has been previously set to this address.

Table 6-5. Commands (cont.)

ISCE	
Description	Sequential command. Loads a byte into the Instrument Status Change Enable register described under "Check the Calibrator Status."
Parameter	The decimal equivalent of the binary number to load into the register.
Example	ISCE 56 Enables bits 3 (BOOST), 4 (RCOMP), and 5 (RLOCK) in the Service Request Enable register.
ISCE?	
Description	Sequential command. Returns the byte from the Instrument Status Change Enable register, described under "Check the Calibrator Status."
Parameter	None
Response	The decimal equivalent of the register contents byte.
Example	ISCE? Returns: "4" if bit 3 (BOOST) is enabled (1) and the rest of the bits are disabled (0). (See "Check the Calibrator Status" for details.)
ISCR?	
Description	Sequential command. Returns and clears the byte from the Instrument Status Change Register, described under "Check the Calibrator Status."
Parameter	None
Response	The decimal equivalent of the register contents byte.
Example	ISCR? Returns: "8" if bit 3 (BOOST) is set (1) and the rest of the bits are reset (0). (See "Check the Calibrator Status" for details.)
ISR?	
Description	Sequential command. Returns and clears the byte from the Instrument Status Register, described under "Check the Calibrator Status."
Parameter	None
Response	The decimal equivalent of the register contents byte.
Example	ISR? Returns: "16" if bit 4 (RLOCK) is set (1) and the rest of the bits are reset (0). (See "Check the Calibrator Status" for details.)
LCOMP_52120	
Description	Overlapped command,. Ignored if not in remote. Sets inductance compensation for attached 52120As.
Parameter	ON (enables LCOMP for all attached 52120s) OFF (disables LCOMP for all attached 52120s)

Table 6-5. Commands (cont.)

LCOMP_52120?	
Description	Sequential command. Returns the current state of inductance compensation for attached 52120As.
Parameter	None
Response	String
Example	LCOMP_52120? Returns ON if LCOMP is enabled.
LIMIT	
Description	Sequential command, ignored if not in remote. Sets the maximum permissible output magnitudes, negative and positive. Both parameters must be present, and the units must be none, volts, or amps. The units must not conflict. If no units are specified, V is assumed.
Parameter	1. Positive limit value with optional multiplier and optional unit. 2. Negative limit value with optional multiplier and optional unit.
Example	LIMIT 1.8 A, -1.2 A Sets the limit for ac and positive dc current to 1.8 A, and negative dc current to -1.2 A.
LIMIT?	
Description	Sequential command. Returns the programmed output magnitude limits for voltage and current.
Response	(Float, float, float, float) 1. Positive voltage limit value 2. Negative voltage limit value 3. Positive current limit value 4. Negative current limit value
Example	LIMIT? Returns: +2.2000000E+02,-1.0000000E+02, +1.8000000E+00,-1.2000000E+00if the programmed voltage range is -100 V to 220 V, and the programmed current range is -1.2 A to 1.8 A.
*LRN?	
Description	Sequential command. Provides the current setting of the Calibrator. The response to this command is a string that recreates the state of the subsequent settings when returned to the Calibrator: Output value Whether the wideband AC Module is on Phase lock Operate/standby Whether an auxiliary amplifier is on Phase shift Guard Range lock Offset Sense Two-wire compensation Scale Output limits
Parameter	None
Response	(String) A string that enables the settings that were set at the time of the *LRN? command.
Example	SETMFC '00000000000024400000000000408F40000000000002440000000000002440000000 000000000000000000003091400000000003091C000000000080764000000000080 76C000B 000158010000000E080000'

Table 6-5. Commands (cont.)

MACADDR?	
Description	Sequential command. Returns MAC/HW address for LAN communication. The MAC address is a unique assigned value and cannot be changed.
Parameter	None
Response	String
Example	MACADDR? Returns six groups of hexadecimal numbers separated by colons (for example, 01:23:45:67:89:ab)
MULT	
Description	Overlapped command, ignored if not in remote. Multiplies the reference magnitude by the parameter and changes the output to the new value. The reference magnitude is the present output in direct operation, and the reference in error mode.
Parameter	Floating-point number to act as a multiplier
Example	If the output is 10 V with error mode off and the command is sent, "MULT 1.9", the output changes to 19 V.
NEWREF	
Description	Sequential command, ignored if not in remote. Sets reference value to be the present output value. (The same as touching the New Reference selection in local operation.)
Parameter	None
OFFSET	
Description	Sequential command, ignored if not in remote. Enables and disables an offset for the output value. Effective immediately when enabled.
Parameter	ON or OFF
OFFSET?	
Description	Sequential command. Returns the offset value if the offset is enabled, otherwise, returns the number 0.0.
Parameter	None
Response	1. (Float) Offset value or 0.0 if no offset is active 2. (Float) Offset units
Example	OFFSET? Returns: "5.05000E-03,V" if an offset of 5.05 mV is active.
OHMSREF?	
Description	Return calculated resistance reference as shown in calibration report (average actual-to-nominal ratio of the 100 ohm to 190 kohm resistors).
Parameter	CAL (From active calibration constants) CHECK (From calibration check constants) PREV (From previous calibration constants)
Response	(Float) The resistance reference value.
Example	OHMSREF? CHECK 1.000021902360723E+00

Table 6-5. Commands (cont.)

OLDREF	
Description	Overlapped command, ignored if not in remote. Sets the Calibrator output to the previously-programmed reference value. (The same as pushing the ENTER in local operation.)
Parameter	None
ONTIME?	
Description	Sequential command. Returns the time in minutes since the Calibrator was turned on.
Parameter	None
Response	(Integer) Number of minutes since power-up this session.
*OPC	
Description	Sequential command. Sets bit 0 (OPC for "Operation Complete") in the Event Status Register to 1 when all pending device operations are complete.
Parameter	None
Response	Sets bit 0 (OPC for "Operation Complete") in the Event Status Register to 1 when all pending device operations are complete.
Example	After sending an OUT command, check if the output has settled by sending *OPC. As soon as the output has settled, a pending *OPC command sets bit 0 (OPC for "Operation Complete") in the Event Status Register to 1. The command to read the ESR is *ESR?.
*OPC?	
Description	Sequential command. Causes program execution to pause until all operations are complete; returns a 1 upon completion of these operations. (See also *WAI.)
Parameter	None
Response	(Integer) "1" after all operations are complete.
Example	If an OUT command had been sent, check if the output has settled by sending *OPC or *OPC?. As soon as the OUT command has completed (output settled), a pending *OPC command places a "1" in the output buffer to be read by the controller.
OPER	
Description	Overlapped command, ignored if not in remote. Activates the Calibrator output if in standby. OPER is inhibited for outputs 22V and over, if there are faults in the fault queue (see "Fault Queue").
Parameter	None

Table 6-5. Commands (cont.)

*OPT?	
Description	Sequential command. Returns a list of analog modules installed in the Calibrator, including any auxiliary amplifiers that are attached.
Parameter	None
Response	(Series of strings) A list of the modules and auxiliary amplifiers, separated by commas.
Example	"5725A Attached","52120 Attached"
OUT	
Description	Overlapped command, ignored if not in remote. Sets the output of the Calibrator and establishes a new reference point for shifting the output to determine UUT error. If only one parameter is supplied, the Calibrator makes the minimum change needed to comply with the requested output. For example, if the Calibrator setting is 1 V, 100 Hz and "OUT 2V" is sent, the setting changes to 2 V, 100 Hz.
Parameter	<ol style="list-style-type: none"> 1. (Optional) Output amplitude with optional multiplier and unit. (At least one parameter must be sent.) 2. (Optional) Output frequency with optional multiplier and unit. (At least one parameter must be sent.)
Example	OUT -15.2 V (-15.2 V; frequency unchanged) OUT 188.3 MA, 442 HZ (188.3 mA, 442 Hz) OUT 1.9 MOHM (1.9 MΩ) OUT 100 HZ (Sets the frequency only)
OUT?	
Description	Sequential command Returns the Calibrator output amplitude and frequency (does not include multipliers).
Parameter	None
Response	<ol style="list-style-type: none"> 1. (Float) Output amplitude 2. (String) Units (V, DBM, A, or OHM) 3. (Float) Frequency (0 if dc or ohms)
Example	1.256983E+01,V,0 (12.56983 V) 1.883E-01,A,4.42E+02 (188.3 mA, 442 Hz) 1.9E+06,OHM,0 (1.9 MΩ)
OUT_ERR?	
Description	Sequential command. Returns the UUT error computed by the Calibrator after the INCR command is used to shift the output.
Parameter	None
Response	<ol style="list-style-type: none"> 1. (Float) UUT error magnitude 2. (String) units for the above number (PPM, PCT, or DB)
PHASE	
Description	Overlapped command, ignored if not in remote. Sets the phase output signal to lead or lag the main output signal by up to 180 degrees.
Parameter	Phase in degrees (-359 to 359, fractions ignored)

Table 6-5. Commands (cont.)

PHASE?	
Description	Sequential command. Returns the phase angle of the variable phase output signal, with respect to the main output signal.
Parameter	None
Response	(Integer) Phase in degrees (0 to 180,-179 to 0, 0 if the output is not ac)
PHASELCK	
Description	Overlapped command, ignored if not in remote. Enables or disables external phase locking, when the Calibrator is supplying an ac voltage.
Parameter	ON (Activates phase locking) OFF (Deactivates phase locking)
PHASESFT	
Description	Overlapped command, ignored if not in remote. Enables or disables the variable phase output, when the Calibrator is supplying an ac voltage.
Parameter	ON (Activates variable phase output) OFF (Deactivates variable phase output)
POST_52120	
Description	Sequential command. Ignored if not in remote. Sets the output terminals for all attached 52120As.
Parameter	1. LO52120, HI52120
Example	POST_52120 LO52120 Selects the low current output terminals for all attached 52120As.
POST_52120?	
Description	Sequential command. Returns the selected output terminals for all attached 52120As.
Parameter	None
Response	String
Example	POST_52120? Returns HI52120 if the high current output terminals are selected for all attached 52120As.

Table 6-5. Commands (cont.)

*PUD	
Description	Sequential command. (Protected user data command.) Allows a string of bytes to be stored in nonvolatile memory. The Calibrator secure state must be set to off. See the RPT_STR command.
Parameter	#0 \<user data> <ASCII Line Feed with EOI> or #<non-zero digit> \<digits> \<user data> For both forms, the bytes received in the \<user data> field are stored in nonvolatile memory, allowing up to 63 bytes. The first form accepts data bytes after the #0 until the ASCII Line Feed character is received with an EOI signal. In the second form, the non-zero digit specifies the number of characters (0 - 9, or ASCII 48 - 57 decimal), in the \<digits> field. The value in the \<digits> field defines the number of user data bytes in the \<user data> field.
Example:	*PUD #0FLUKE<Line Feed with EOI> or *PUD #15FLUKE Both examples store the word FLUKE in the protected user data area. <i>Note</i> <i>The 1 indicates that one digit must follow (in this case '5'), and the 5 indicates that five characters are in the remainder of the *PUD message (in this case, FLUKE).</i>
*PUD?	
Description	Sequential command. Returns the contents of the *PUD (Protected User Data) memory.
Parameter	None
Response	#(non-zero digit) (digits) (user data) The non-zero digit specifies the number of characters that will follow in the \<digits> field. These characters are 0 through 9 (ASCII 48 through 57 decimal). The value of the number in the \<digits> field defines the number of user data bytes that follow in the \<user data> field. The maximum response is 64 characters.
Example	*PUD? Returns: "205FLUKE" assuming that this is stored as in the example for PUD* above.
RANGE?	
Description	Sequential command. Returns the present output range.
Parameter	None
Response	(String) Symbolic name of the range from Table 5-4.
RANGELCK	
Description	Overlapped command, ignored if not in remote. Locks or unlocks the present output range. The range automatically unlocks if the output function changes, for example from dc volts to dc current.
Parameter	ON (Locks the range) OFF (Unlocks the range)

Table 6-5. Commands (cont.)

RCOMP	
Description	Overlapped command, ignored if not in remote. While a resistance output 19 k Ω or lower is selected, RCOMP activates or deactivates two-wire ohms compensation circuitry.
Parameter	ON (Turns on the two-wire compensation circuitry) OFF (Turns off the two-wire compensation circuitry)
REFOUT?	
Description	Sequential command. Returns the value of the reference, which is the output value of the Calibrator the last time a new reference was established with an OUT, NEW_REF, or MULT.
Parameter	None
Response	1. (Float) Output amplitude 2. (String) Units (V, A, OHM, or DBM) 3. (String) Frequency (0 if dc)
REM_MODE	
Description	Sequential command. Ignored if not in remote. Sets the response type for a specified remote port.
Parameter	1. SERIAL, USB, ENET 2. COMP, TERM
Example	REM_MODE SERIAL, COMP Sets the response type for serial communication to COMPUTER REM_MODE ENET, TERM Sets the response type for Ethernet communication to TERMINAL.
REM_MODE?	
Description	Sequential command. Returns the response type for a specified remote port.
Parameter	1. SERIAL, USB, ENET
Response	String
Example	REM_MODE? SERIAL Returns TERM if the serial response type has been set to TERMINAL mode
RPT_STR	
Description	Sequential command. Loads the user report string. The user report string can be read on the Display in local operation, and appears on calibration reports. The Calibrator secure state must be set to off.
Parameter	String of up to 40 characters

Table 6-5. Commands (cont.)

RPT_STR?	
Description	Sequential command. Returns the user report string. The user report string can be read on the Display in local operation, and appears on calibration reports.
Parameter	None
Response	(String) Up to 40 characters
*RST	
Description	Overlapped command, ignored if not in remote. (Reset.) Sets the Calibrator to its power-up default state: 0V, 0 Hz, Standby, [BOOST] off, [W BND] off, [EX GRD] off, [EX SNS] off, phase lock off, phase shift off, range lock off, [SCALE] off, [OFFSET] off, two-wire compensation off, and entry limits set to defaults. *RST does not affect any of the following: <ul style="list-style-type: none"> • State of the IEEE-488 interface • Selected bus address • Status Register Enable setting • Contents of nonvolatile memory *RST also re-secures the Calibrator security state to ON.
SCALE	
Description	Sequential command, ignored if not in remote. Turns scaling on or off. (The same as touching the Scale indicator on the display.)
Parameter	ON or OFF
SCALE?	
Description	Sequential command. Returns the full-scale nominal and full-scale actual values set when SCALE more was turned on. If scaling is off, both responses one and two are "0.0."
Responses	1. (Float) Nominal full-scale value 2. (Float) Actual full-scale value 3. (String) V, A, or DBM, units for the first two responses
SCAL_ERR?	
Description	Sequential command. Returns the value of the scale error if scaling is on, otherwise, this command returns 0.0.
Parameter	None
Response	1. (Float) Scale error 2. (String) Units for scale error

Table 6-5. Commands (cont.)

SP_EOF	
Description	Sequential command, ignored if not in remote. Sets the End-Of-File character string for the RS-232-C serial interface. The EOF setting is saved when the power is turned off.
Parameter	1. ASCII code (decimal) for the first character 2. ASCII code (decimal) for the second character (A "0" for parameter 1 or 2 means that there is no character in that position.)
SP_EOF?	
Description	Sequential command. Returns the End-Of-File character string.
Parameter	None
Response	1. (Integer) ASCII code in decimal for the 1st character 2. (Integer) ASCII code in decimal for the 2nd character (A "0" for response 1 or 2 means there is no character in that position.)
SP_SET	
Description	Sequential command, ignored if not in remote. Sets the serial port settings and saves them in nonvolatile memory.
Parameter	One or more of the following, in any order: 1. Baud rate as 9600, 19200, 38400, 57600 or 115200 2. TERM or COMP (See note below) 3. XON, RTS, or NOSTALL (Stall method) 4. DBIT7 or DBIT8 (Data bits) 5. SBIT1 or SBIT2 (Stop bits) 6. PNONE, PEVEN, PODD, or PIGNORE (Parity) 7. CR, LF, or CRLF (End-Of-Line) <i>Note</i> <i>The TERM or COMP parameter sets the responses in serial remote control to be appropriate for interactive terminal use or operation under program control. Specifying TERM sets the remote port to expect a human operator using a terminal. Specifying COMP sets the remote port to expect a computer program to be controlling the Calibrator. (This command has the same effect as setting Remote I/F to TERMINAL or COMPUTER in the RS-232C Port Setup Menu.)</i>
Default	9600,TERM,XON,DBIT8,SBIT1,PNONE,CRLF
Example	19200,COMP,XON,DBIT8,SBIT1,PEVEN,CRLF

Table 6-5. Commands (cont.)

SP_SET?	
Description	Sequential command. Returns the serial port settings contained in nonvolatile memory.
Response	<ol style="list-style-type: none"> 1. (Integer) One of these baud rates: 9600, 19200, 38400, 57600 or 115200 2. (String) TERM or COMP (Response type) 3. (String) XON, RTS, or NOSTALL (Stall method) 4. (String) DBIT7 or DBIT8 (Data bits) 5. (String) SBIT1 or SBIT2 (Stop bits) 6. (String) PNONE, PEVEN, PODD, or PIGNORE (Parity) 7. (String) CR, LF, or CRLF (End-Of-Line)
Example	9600,TERM,XON,DBIT8,SBIT1,PNONE,CRLF
*SRE	
Description	Sequential command. Loads a byte into the Service Request Enable register (SRE), described under "Check the Calibrator Status."
Parameter	The decimal equivalent of the binary number to load into the register.
Example	*SRE 56 Enables bits 3 (EAV), 4 (MAV), and 5 (ESB) in the Service Request Enable register.
*SRE?	
Description	Sequential command. Returns the byte from the Service Request Enable register, described under "Check the Calibrator Status."
Parameter	None
Response	(Integer) The decimal equivalent of the register byte.
Example	*SRE? Returns: "56" if bits 3 (EAV), 4 (MAV), and 5 (ESB) are enabled (1) and the rest of the bits are disabled (0). (See "Check the Calibrator Status" for details.)

Table 6-5. Commands (cont.)

STATE?																																									
Description	Sequential command. Returns the long-term state of the Calibrator.																																								
Parameter	None																																								
Response	<p>1. (Integer) Gross state, with the subsequent responses:</p> <table border="0"> <tr> <td>0</td> <td>Operating</td> <td>10</td> <td>Calibration, wideband positive gain</td> </tr> <tr> <td>1</td> <td>Self diagnostics</td> <td>11</td> <td>Calibration, wideband negative gain</td> </tr> <tr> <td>2</td> <td>Self diagnostics halted by a fault</td> <td>12</td> <td>Wideband flatness calibration, adjustment</td> </tr> <tr> <td>3</td> <td>Calibration check</td> <td>13</td> <td>Wideband flatness calibration, reference point</td> </tr> <tr> <td>4</td> <td>DC zeros calibration</td> <td>14</td> <td>Range calibration</td> </tr> <tr> <td>5</td> <td>Calibration, +dc reference</td> <td>15</td> <td>5725A voltage diagnostics</td> </tr> <tr> <td>6</td> <td>Calibration, -dc reference</td> <td>16</td> <td>5725A current troubleshooting</td> </tr> <tr> <td>7</td> <td>Calibration, 1 Ω reference</td> <td>17</td> <td>Reserved</td> </tr> <tr> <td>8</td> <td>Calibration, 10 kΩ reference</td> <td>18</td> <td>Reserved</td> </tr> <tr> <td>9</td> <td>Calibration, internal adjustment</td> <td>19</td> <td>Analog output tripped to dormant</td> </tr> </table> <p>2. (String) Substate: 20. Starting up If operating, self-calibrating, diagnosing, or testing, returns a descriptive string of the activity underway.</p>	0	Operating	10	Calibration, wideband positive gain	1	Self diagnostics	11	Calibration, wideband negative gain	2	Self diagnostics halted by a fault	12	Wideband flatness calibration, adjustment	3	Calibration check	13	Wideband flatness calibration, reference point	4	DC zeros calibration	14	Range calibration	5	Calibration, +dc reference	15	5725A voltage diagnostics	6	Calibration, -dc reference	16	5725A current troubleshooting	7	Calibration, 1 Ω reference	17	Reserved	8	Calibration, 10 k Ω reference	18	Reserved	9	Calibration, internal adjustment	19	Analog output tripped to dormant
0	Operating	10	Calibration, wideband positive gain																																						
1	Self diagnostics	11	Calibration, wideband negative gain																																						
2	Self diagnostics halted by a fault	12	Wideband flatness calibration, adjustment																																						
3	Calibration check	13	Wideband flatness calibration, reference point																																						
4	DC zeros calibration	14	Range calibration																																						
5	Calibration, +dc reference	15	5725A voltage diagnostics																																						
6	Calibration, -dc reference	16	5725A current troubleshooting																																						
7	Calibration, 1 Ω reference	17	Reserved																																						
8	Calibration, 10 k Ω reference	18	Reserved																																						
9	Calibration, internal adjustment	19	Analog output tripped to dormant																																						
*STB?																																									
Description	Sequential command. Returns the status byte. The status byte is described under "Status Information."																																								
Parameter	None																																								
Response	(Integer) Decimal equivalent of the status byte.																																								
Example	*STB? Returns: "72" if bits 3 (EAV) and 6 (MSS) are set (1) and the rest of the bits are reset (0).																																								
STBY																																									
Description	Overlapped command, ignored if not in remote. Puts the Calibrator in standby.																																								
Parameter	None																																								
SUBNETMASK																																									
Description	Sequential command. Ignored if not in remote. Sets Ethernet subnet mask for LAN communication when NOT in DHCP mode.																																								
Parameter	Subnet mask (quoted string consisting of 4 decimal values bound between 0-255 separated by periods).																																								
Example	SUBNETMASK "255.255.254.0" Sets the Ethernet subnet mask to 255.255.254.0																																								

Table 6-5. Commands (cont.)

SUBNETMASK?	
Description	Sequential command. Returns Ethernet subnet mask for LAN communication.
Parameter	None
Response	String
Example	SUBNETMASK? Returns 255.255.254.0 if the subnet mask was previously set to this value.
*TST?	
Description	Sequential command, ignored if not in remote. Initiates a series of self-tests, then returns a "0" for pass or a "1" for fail. If any faults are detected, they are logged into the fault queue where they can be read by the FAULT? query.
Parameter	None
Response	(Integer) 0 (for Pass) or 1 (for Fail)
UNCERT?	
Description	Sequential command. Returns the calculated maximum uncertainty of the Calibrator output according to the selected calibration interval.
Parameter	None
Response	<ol style="list-style-type: none"> 1. (Float) Uncertainty of the Calibrator output (-1.0 if no specification is available) 2. (String Units for response 1 (PPM, PCT, V, A, OHM, etc.)) 3. (Integer) The specification interval in days.
VOUT?	
Description	Sequential command. Returns the output amplitude expressed in volts if the currently selected units are dBm.
Parameter	None
Response	<ol style="list-style-type: none"> 1. (Float) Output amplitude 2. (String) V, A, OHM, units for response 1 3. (Float) Frequency
Example	Assuming a value of 10 dBm, 10 kHz is currently active on the main output terminals, VOUT? returns: "2.4494897E+00,V,1.0000E+04"

Table 6-5. Commands (cont.)

*WAI	
Description	Sequential command. (Wait-to-Continue.) This command prevents further remote commands from being executed until all previous remote commands have been executed. (See also *OPC.)
Parameter	None
Example	If an OUT command had been sent, it can cause the Calibrator to wait until the output has settled before continuing on to the next command by following OUT with a *WAI command. This is useful because OUT is an overlapped command, which means the Calibrator would normally go on to process other commands before completing the OUT command.
WBAND	
Description	Overlapped command, ignored if not in remote. Activates or deactivates output from the Wideband AC Module (Option 5730A/03). This has the same action as touching the wideband selection from the front panel during local operation.
Parameter	ON or OFF
XFER	
Description	Turns ac/dc transfers off (or on) after output has settled.
Parameter	OFF or ON
Example	XFER OFF turns transfers off (ON is the default)
XFER?	
Description	Returns whether ac/dc transfers after settling are turned on.
Parameter	None
Example	ON or OFF
XFERCHOICE	
Description	Sets whether the choice to turn ac/dc transfers off is given on the front panel GUI for ac V outputs.
Parameter	ON or OFF
Example:	XFERCHOICE OFF omits the choice from the front panel (this is the default setting).
XFERCHOICE?	
Description	Returns whether the choice to turn ac/dc transfers off is given on the front panel GUI for ac V outputs.
Parameter	None
Response	ON or OFF

Table 6-6. Serial Remote Control Commands

LOCAL	
Description	Sequential command. Enables the local state. This command duplicates the IEEE-488-GTL (Go to Local) message.
Parameter	None
LOCKOUT	
Description	Sequential command. Enables the local lockout state. This command duplicates the IEEE-488 LLO (Local Lockout) message.
Parameter	None
REMOTE	
Description	Sequential command. Enables the remote state. This command duplicates the IEEE-488 REN (Remote Enable) message.
Parameter	None

Table 6-7. Range Identifiers for Remote Commands

Function	Ranges				
DC Voltage	DC220MV DC1100V	DC2_2V	DC11V	DC22V	DC220V
DC Current	DC220UA DC5725A	DC2_2MA DC52120A_2A	DC22MA DC52120A_20A	DC220MA DC52120A_100A	DC2_2A
AC Voltage	AC2_2MV AC220V	AC22MV AC1100V	AC220MV AC5725A	AC2_2V	AC22V
AC Current	AC220UA AC5725A	AC2_2MA AC52120A_2A	AC22MA AC52120A_20A	AC220MA AC52120A_120A	AC2_2A
Resistance	OHM0 OHM100 OHM19K OHM10M	OHM1 OHM190 OHM100K OHM19M	OHM1_9 OHM1K OHM190K OHM100M	OHM10 OHM1_9K OHM1M	OHM19 OHM10K OHM1_9M
Wideband	WB1_1MV WB330MV	WB3_3MV WB1_1V	WB11MV WB3_5V	WB33MV	WB110MV

Local-to-Remote State Transitions

The 5730A Calibrator can be operated either locally from the front panel, or remotely with remote control commands. In addition to front panel and remote control operation, the controller can be placed in a local lockout condition at any time by remote command. When combined, the local, remote, and lockout conditions yield four possible operating states:

- **Local (Front-Panel Operation)**
The Calibrator responds to local and remote commands, but only remote commands that do not affect the state of the Calibrator are allowed to execute. For example, OUT? returns the value of the Calibrator output setting and is executable in the local state. OUT sets the output to another value but cannot be executed in local state.
- **Local with Lockout**
Local with lockout is identical to local, except the Calibrator will go into the remote with lockout state instead of the remote state when it receives a remote command. The local with lockout state is entered by executing the LOCKOUT statement from an IEEE-488 controller, or by sending the LOCKOUT command from a RS-232C/UCB/Ethernet controller.
- **Remote**
When the Remote Enable (REN) line is asserted and the controller addresses the Calibrator as a listener, it enters the remote state. These conditions are met, for example, when a GPIB controller executes the statement “OUT 10 V, 1kHz;OPER”. In the remote state, display changes to:

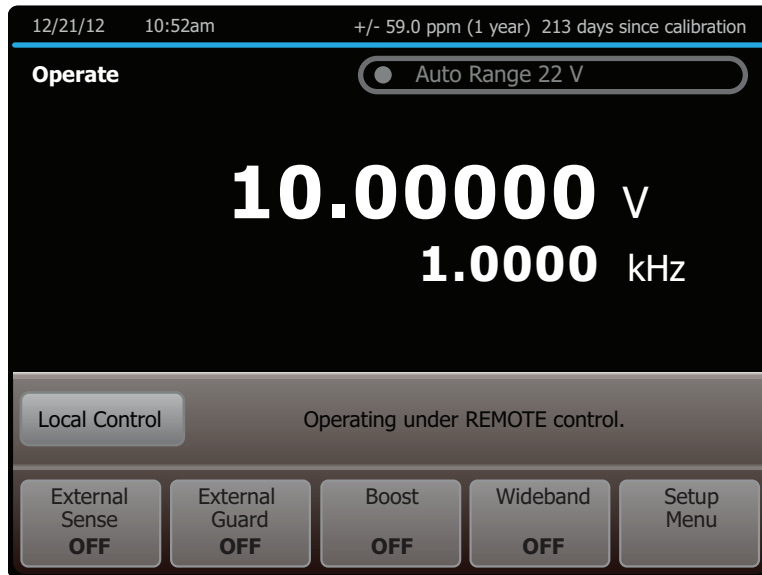

hhp150.eps

Front panel operation is restricted to use of the power switch and the **Local Control** selection. Touch **Local Control** or send the GTL (Go To Local) interface message to return the Calibrator to the local state. (One way to send the GTL interface message in some controllers is by executing the LOCAL statement.)

- Remote with Lockout

The remote with lockout state can be entered from remote or local with lockout, but not directly from local. Remote with lockout is similar to the remote state, but restricted: the **Local Control** is not shown on the display. To return the Calibrator to the local with lockout state, the GPIB controller sends GTL. (With some IEEE-488 controllers, this can be done manually by executing a WBYTE statement.) To return the Calibrator to the local state, the GPIB controller unasserts the REN control line. When the Calibrator is in remote with lockout, the display appears as follows:

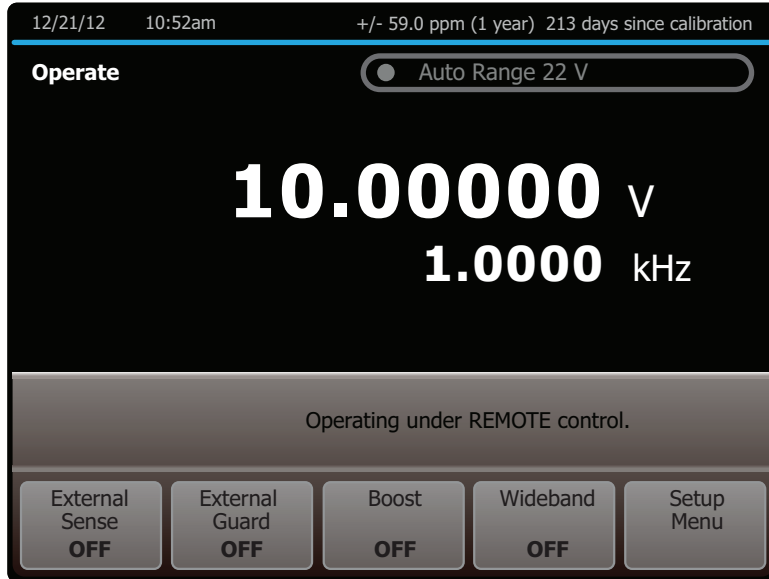

hhp151.eps

Table 6-8 summarizes the possible Remote/Local state transitions.

Table 6-8. Operating State Transitions

From	To	Use	Typical GPIB Command
Local	Remote	MAL + REN	REMOTE
	Local/Lockout	LLO + REN	LOCKOUT
Remote	Local	GTL or LOCAL CONTROL selection	LOCAL
	Remote/Lockout	LLO + REN	LOCKOUT
Local/Lockout	Remote/Lockout	MLA + REN	REMOTE or any Calibrator command
Remote/Lockout	Local	REN not	LOCAL
	Local/Lockout	GTL	Manually using WBYTE

Check the Calibrator Status

The controller has access to six status registers for the 5730A Calibrator, which indicate the Calibrator conditions in the as shown in Figure 6-1. Each register bit is explained under separate headings for each register. Table 6-9 lists each register and its remote commands.

In addition to the status registers, the Service Request control line, SRQ (available only when an IEEE-488 controller is used) and a 16-element buffer called the Fault Queue provide status information.

Table 6-9. Status Register Summary

Register	READ Command	WRITE Command	Enable Register
Status Byte Register (STB)	*STB? (or SPL() for some controllers)	None	SRE
Service Request Enable Register (SRE)	*SRE?	*SRE	None
Event Status Register (ESR)	*ESR?	None	ESE
Event Status Enable Register (ESE)	*ESE?	*ESE	None
Instrument Status Register (ISR)	ISR?	None	None
Instrument Status Change Register (ISCR)	ISCR?	None	ISCE
Instrument Status Change Enable Register (ISCE)	ISCE?	ISCE	None

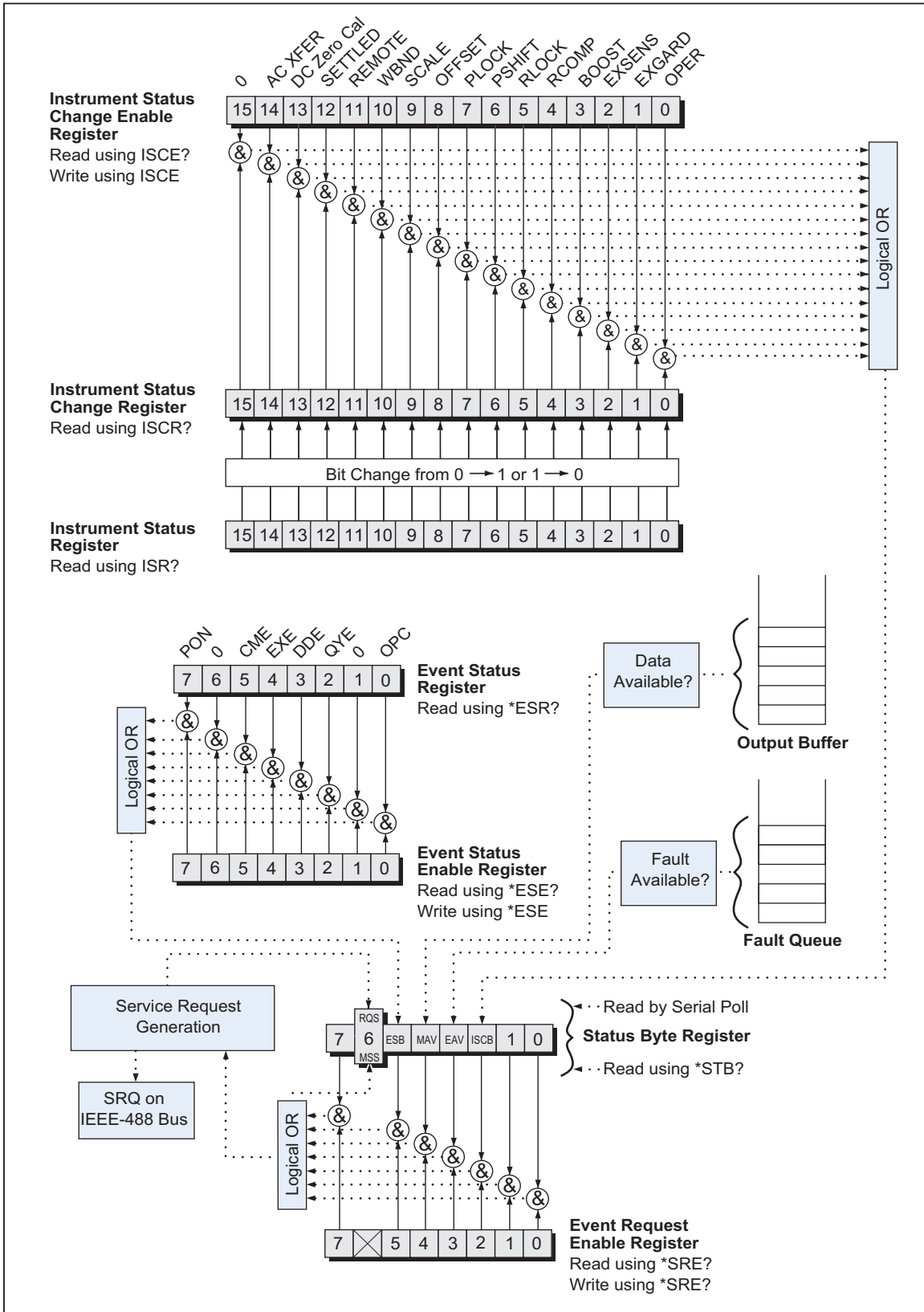

Figure 6-1. Overview of Status Data Structure

hhp050.eps

Status Byte Register

The most important and frequently used register is the Status Byte Register, which is how the 5730A Calibrator responds to a serial poll. This byte is cleared (set to 0) when the power is turned on. A serial poll cannot be done if the RS-232C/USB/Ethernet port is used as the remote control interface. Instead, the *STB? command can be sent to get the same information. Its bits are defined as follows (bits 7, 1, and 0 are always 0):

7	6	5	4	3	2	1	0
0	RQS	ESB	MAV	EAV	ISCB	0	0
	MSS						

RQS Requesting Service. The RQS bit is set to 1 whenever bits ESB, MAV, EAV, or ISCB change from 0 to 1 and are enabled (1) in the SRE. When RQS is 1, the Calibrator asserts the SRQ control line on the IEEE-488 interface. A serial poll can be done to read this bit to see if the Calibrator is the source of an SRQ.

MSS Master Summary Status. Set to 1 whenever bits ESB, MAV, EAV, or ISCB are 1 and enabled (1) in the SRE. This bit can be read with the *STB? command in RS-232C/USB/Ethernet remote control in place of doing a serial poll.

ESB Set to 1 when one or more enabled ESR bits are 1.

MAV Message Available. The MAV bit is set to 1 whenever data is available in the Calibrator IEEE-488 interface output buffer.

EAV Error (fault) available. A fault has occurred and a fault code is available through the FAULT? query.

ISCB One or more enabled ISCR bits are 1.

Service Request Line (SRQ)

Service Request (SRQ) is an IEEE-488.1 bus control line that the Calibrator asserts to notify the controller that it requires some type of service. Many instruments can be on the bus, but they all share a single SRQ line. To determine which instrument set SRQ, the Controller normally does a serial poll of each instrument. The Calibrator asserts SRQ whenever the RQS bit in its Status Byte Register is 1. This bit informs the controller that the Calibrator was the source of the SRQ.

The Calibrator clears SRQ and RQS when the controller does a serial poll of the Calibrator IEEE-488 interface, sends *CLS, or when the MSS bit is cleared. The MSS bit is cleared only when ESB, MAV, EAV, and ISCB are 0, or they are disabled by their associated enable bits in the SRE register being set to 0.

Service Request Enable Register

The Service Request Enable Register (SRE) enables or masks the bits of the Status Byte Register. The SRE is cleared at power up. Refer to “Status Byte Register” for the bit functions.

Load the SRE

By resetting (to 0) the bits in the SRE, associated bits in the Status Byte Register can be masked (disabled). Bits set to 1 enable the associated bit in the Status Byte Register.

Event Status Register

The Event Status Register is a two-byte register that the higher eight bits are always 0, and the lower eight bits except bits 6 and 1 represent various conditions of the Calibrator. The ESR is cleared (set to 0) when the power is turned on, and every time it is read.

A mask register called the Event Status Enable register (ESE) allows the controller to enable or mask (disable) each bit in the ESR. When a bit in the ESE is 1, the corresponding bit in the ESR is enabled. When any enabled bit in the ESR is 1, the ESB bit in the Status Byte Register also goes to 1. The ESB bit stays 1 until the controller reads the ESR or sends the *CLS command to the Calibrator. The ESE is cleared (set to 0) when the power is turned on.

Bit Assignments for the ESR and ESE

15	14	13	12	11	10	9	8
0	0	0	0	0	0	0	0

7	6	5	4	3	2	1	0
PON	0	CME	EXE	DDE	QYE	0	OPC

- PON** Power on. This bit is set to 1 if the power supply has been turned off and on since the last time the ESR was read.
- CME** Command error (fault). The Calibrator remote interface encountered an incorrectly formed command. (The command FAULT? fetches the earliest fault code in the fault queue, which contains fault codes for the first 15 faults that have occurred.)
- EXE** Execution error (fault). A fault occurred when the Calibrator tried to execute the last command. One possible cause for this error is a parameter that is out of range. (The command FAULT? fetches the earliest fault in the fault queue, which contains fault codes for the first 15 faults that have occurred.)
- DDE** Device-dependent error (fault). A fault related to a device-dependent command has occurred. One possible cause for this error would be an attempt to execute "OUT 1000000V", which is outside the Calibrator range. (The command FAULT? fetches the earliest fault in the fault queue, which contains fault codes for the first 15 faults that have occurred.)
- QYE** Query error (fault). The Calibrator was addressed to talk when no response data was available or appropriate, or when the controller failed to retrieve data on the output queue.
- OPC** Operation complete. All commands previous to reception of an *OPC command have been executed, and the interface is ready to accept another message.

Read the ESR and ESE

To read the contents of the ESR, send the remote command, *ESR?. The ESR is cleared (set to 0) every time it is read. To read the contents of the ESE, send the remote command, *ESE?. The ESE is not cleared when it is read. When either register is read, the Calibrator responds by sending a decimal number that represents bits 0 through 15.

Load the ESE

Resetting the bits in the ESE can mask (disable) the associated bits in the ESR. For example, to prevent the occurrence of a command fault from causing bit 5 (ESB) in the Status Byte Register to go to 1, bit 5 in the ESE register can be reset to 0.

Instrument Status Register

The Instrument Status Register (ISR) gives the controller access to the state of the Calibrator, including some of the information presented to the operator on the display and the display annunciators during local operation.

Instrument Status Change Register

The Instrument Status Change Register (ISCR) indicates which ISR bits have changed status (from 0 to 1 or from 1 to 0) since the ISCR was last read. The ISCR is cleared (set to 0) when the Calibrator is turned on, and every time it is read.

Instrument Status Change Enable Register

The Instrument Status Change Enable Register (ISCE) is a mask register for the ISCR. If a bit in the ISCE is enabled (set to 1) and the corresponding bit in the ISCR goes to 1, the ISCB bit in the Status Byte is set to 1. If all bits in the ISCE are disabled (set to 0), the ISCB bit in the Status Byte never goes to 1. The ISCE is cleared on power-up.

Bit Assignments for the ISR, ISCR, and ISCE

15	14	13	12	11	10	9	8
0	AC XFER	ZERO CAL	SETTLED	REMOTE	WBND	SCALE	OFFSET

7	6	5	4	3	2	1	0
PLOCK	PSHFT	RLOCK	RCOMP	BOOST	EXSENS	EXGARD	OPER

ZERO CAL	When 1, DC Zero Cal is necessary.
ACXFER	When 1, ac/dc transfer is active.
SETTLED	When 1, the output has stabilized to within specification.
REMOTE	When 1, the Calibrator is under remote control.
WBND	When 1, the wideband is active.
SCALE	When 1, scaling is active.
OFFSET	When 1, an offset is active.
PLOCK	When 1, the Calibrator output is phase locked to an external source.
PSHFT	When 1, variable phase output is active.
RLOCK	When 1, the Calibrator output range is locked.
RCOMP	When 1, two-wired compensation is active when in resistance mode.
BOOST	When 1, an auxiliary amplifier is active.
EXSENS	When 1, external sensing is selected.
EXGARD	When 1, external voltage guard is selected.
OPER	When 1, the Calibrator is operating, When 0, it is in standby.

Read the ISR, ISCR, or ISCE

To read the contents of the ISR, send the remote command, `ISR?`. In a similar fashion, to read the contents of the ISCR, send `ISCR?`, and to read the contents of the ISCE, send `ISCE?`. The Calibrator returns a decimal number representing bits 0 through 15. Each time the ISCR is read, its contents are zeroed.

Load the ISCE

By resetting the bits in the ISCE, the associated bits in the ISCR can be masked (disabled). For example, to cause an SRQ interrupt when an attached 5725A Amplifier turns on, bit 3 (BOOST) in the ISCE register must be 1. (The ISCB bit must also be enabled in the SRE.)

Fault Queue

When a command fault, execution fault, or device-dependent fault occurs, its fault code is placed in the fault queue where it can be read by the `FAULT?` command. All fault codes are defined in Appendix A of this manual. Another way to decode a fault code is to send the command, `EXPLAIN?`, which returns a description of a fault code. Reading the first fault with the `FAULT?` command removes that fault from the queue. A response of 0 means the fault queue is empty.

The fault queue contains up to 16 entries. If many faults occur, only the first 15 faults are kept in the queue. A 16th entry in the queue is always a "fault queue overflow" fault, and all later faults are discarded until the queue is at least partially read. The first faults are kept, because if many faults occur before the user can acknowledge and read them, the earliest faults are the most likely to point to the problem. The later faults are usually repetitions or consequences of the original problem.

The OPER command is inhibited for outputs of 22 V or greater whenever there is a fault in the fault queue. The OPER command remains inhibited until either the fault queue or the ESR is cleared.

Note

*The Calibrator Main CPU software revision levels can be checked with the Instmt Config Menu, or *IDN? remote command.*

After the Calibrator has encountered a fault, do one of the subsequent actions to reenble the OPER command:

1. Send *CLS (to clear the ESR and fault queue)
2. Send *ESR? (to read and clear the ESR)
3. Repeatedly send the FAULT? query until 0 is returned, indicating that all faults from the queue have been read and cleared.

Chapter 7

Operator Maintenance and Calibration

Introduction

This chapter explains how to do the routine maintenance and calibration tasks necessary to keep the 5730A Calibrator in optimal operating condition. For intensive maintenance tasks such as troubleshooting or repair, contact a Fluke Calibration Service Center. See “How to Contact Fluke Calibration” in Chapter 1.

Fuse Replacement

Access the fuse from the rear panel. The fuse rating label below the fuse holder shows the correct replacement fuse ratings for each operating voltage.

Warning



To prevent possible electrical shock, fire, or personal injury:

- **Turn the Product off and remove the mains power cord. Stop for two minutes to let the power assemblies discharge before you open the fuse door.**
- **Replace a blown fuse with exact replacement only for continued protection against arc flash.**
- **Use only specified replacement fuses, see Table 7-1.**

To access the fuse, refer to Figure 7-1:

1. Disconnect the mains power cord.
2. With a standard screwdriver, release the fuse holder door.
3. Pull out the fuse holder.
4. If necessary, replace the fuse.
5. Reinsert the fuse holder.
6. Close the fuse holder door.

Table 7-1. Replacement Fuses

Line Voltage Range	Fuse Description	Fluke Part Number
 100 V – 120 V	T 3 A 250 V	109280
 220 V – 240 V	T 1.5 A 250 V	109231

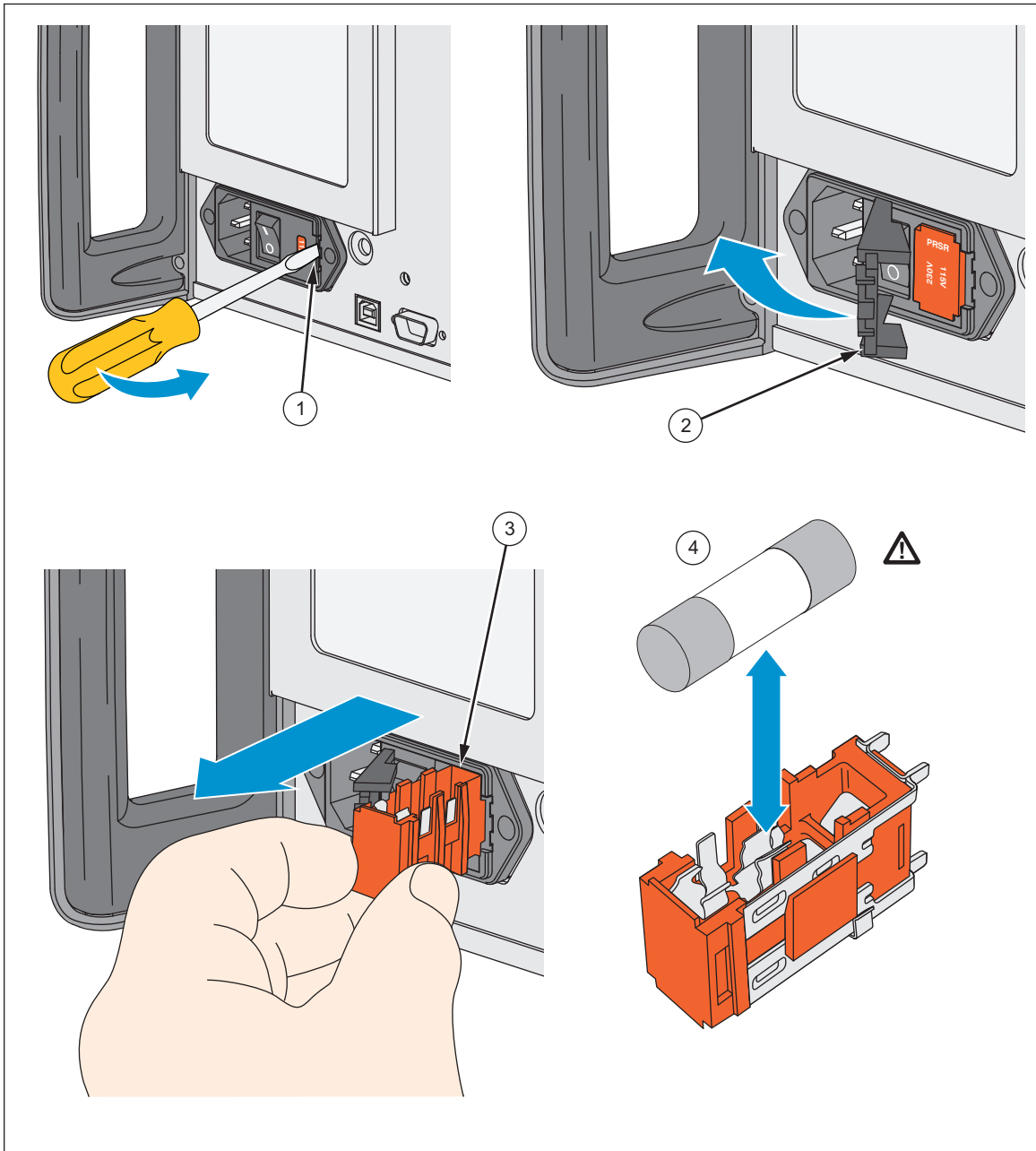

Figure 7-1. Access the Fuse

hhp003.eps

Clean the Air Filter

⚠ Caution

Damage caused by overheating can occur if the area around the fan is restricted, the intake air is too warm, or the air filter becomes clogged.

To prevent Product damage, make sure that the filter is completely dry before reinstallation.

The air filter must be removed and cleaned at least every 30 days, or more frequently if the Calibrator is operated in a dusty environment. The air filter is accessible from the rear panel of the Calibrator.

To clean the air filter, refer to Figure 7-2:

1. Disconnect line power.
2. Unscrew the knurled screw at the top of the air filter and pull the filter retainer downwards (it is hinged at the bottom) to remove the filter.
3. Clean the filter by washing it in soapy water. Rinse and dry it thoroughly.
4. Reinstall the filter and the knurled screw.

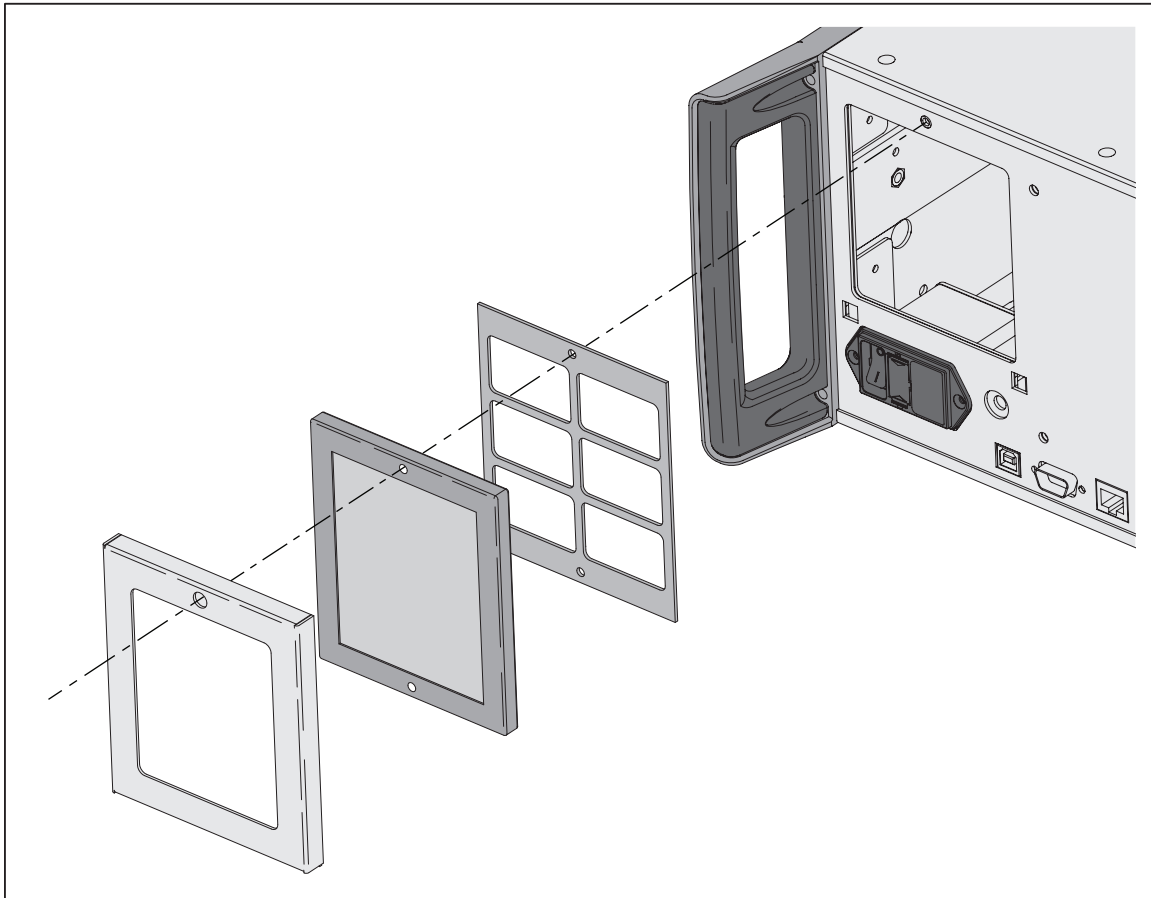

Figure 7-2. Air Filter Access

hhp026.eps

Clean the Exterior

To keep the 5730A Calibrator looking new, clean the case, front panel keys, and display with a soft cloth slightly dampened with either water or a non-abrasive mild cleaning solution that is not harmful to plastics.



Caution

Do not use aromatic hydrocarbons or chlorinated solvents for cleaning. They can damage the plastic materials used in the Product.

User-Replaceable Parts

User-replaceable parts are listed in Table 7-2 and shown in Figure 7-3. For more information about these items contact a Fluke Calibration representative. See the “Contact Fluke Calibration” section of this manual.

Table 7-2. User-Replaceable Parts

Item Number	Description	Part Number
①	Top Cover	4104376
②	Handle	4104383
③	Side Extrusion	3468705
④	Insert Extrusion	4104451
⑤	Bottom Cover	4219600
⑥	USB Decal	4219557
⑦	Input Decal	4219569
⑧	Encoder Knob	4222803
⑨	5730A Decal	4233853
⑩	Air Filter	813493
⑪	 Fuse (100 V – 120 V, T 3 A 250 V)	109280
⑪	 Fuse (220 V – 240 V, T 3 A 250 V)	109231
Not Shown	5730A Manuals CD	4290581
Not Shown	5730A Getting Started Manual	4290571

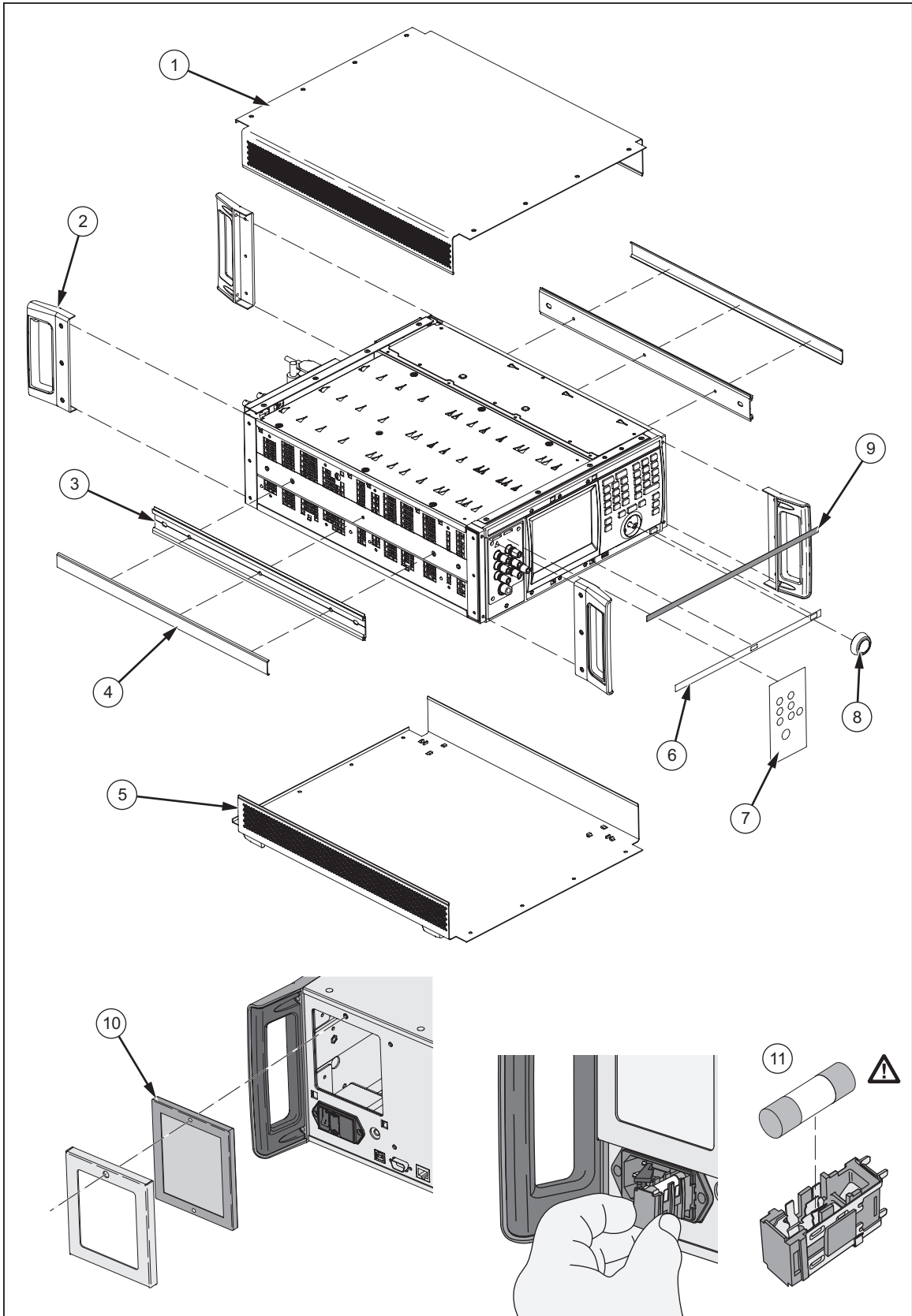

Figure 7-3. Replaceable Parts

hhp224.eps

5730A Calibration

The 5730A Calibrator makes use of internal check standards and measurement systems. As a result, it can be completely calibrated in place to full specifications with a small number of convenient, portable, environmentally-tolerant standards available from Fluke Calibration. This procedure is traceable to military standard requirements.

When manufactured, each Product is calibrated and thoroughly verified with process metrology and calibration standards traceable to the International System of units (SI) through well-recognized national metrology institutes. A certificate of calibration that is accredited to ISO 17025 is included.

The calibration verification procedure is recommended every 2 years or as required by established policies. This procedure involves no adjustments. It ensures internal processes are in control, and establishes parallel external traceability paths for internal functions such as ac transfers that are never adjusted or corrected.

The Artifact Calibration Process

Calibration requires only three external standards or artifacts: 10 V, 1 Ω , and 10 k Ω . Environmentally-controlled internal check standards provide the primary reference points. A stored table of calibration constants defines additional reference points for controlling the output. Traceable calibration and adjustment to the specified level of performance is accomplished in a semi-automated process that revises this table.

When finished with artifact calibration, but before the new constants are saved, the 5730A Calibrator presents the proposed adjustments as +/- ppm of range and percentage change in specification for each range and function. A list of changes can be sent to the computer through the serial port, USB device port, Ethernet port, or the IEEE-488 port using the remote command: CAL_RPT? CHECK. Also on completion of calibration, the Calibrator shows the largest proposed change.

Calibration can be completed as far as deriving and printing the proposed adjustments without entering the calibration protection passcode. To save the changes in non-volatile memory to adjust future outputs from the Calibrator, the passcode must be entered from the front panel or with a remote command. The passcode entry menu is shown on the display when necessary.

Establish Traceability

Traceability to national standards is established as follows:

- Except for the internal ac/dc transfer standard, the internal check standards are directly calibrated by traceable external standards every time the Calibrator is calibrated.
- The internal ac/dc transfer standard is never adjusted, so its traceability is not disturbed by calibration. Infrequent verification is done in the traditional way, by comparing selected ac voltage outputs with an external dc voltage standard through an external ac/dc transfer standard. Fluke Calibration recommends this to be done every two years or as determined by the policy of your organization.
- Infrequent independent verification is also done on stable parameters, such as frequency flatness, determined more by circuit geometry and dielectric constants than time.

Calibration Reports

The 5730A Calibrator stores two sets of calibration constants: the set currently in use and the old set from the previous calibration. This gives the Calibrator the ability at any time to produce a calibration report of the differences between the present settings and the settings that were in effect before the last calibration. The report shows shifts in various output values from before to after the most recent calibration for each range and function in +/- ppm of range and in percentage of specification limit. The report can be saved to a USB drive or retrieve it from a host computer through either the RS-232, USB device port, Ethernet port, or IEEE-488 interface.

Range Adjustment

After calibration, further fine adjustments can be made to each range. Range adjustments are optional and they are not necessary to meet total uncertainty specifications. However, they can help to align the Calibrator closer to in-house standards.

Before range calibration is done, first do the Artifact Calibration as described later in this chapter. This is to calibrate the ranges that will not be adjusted. It also performs an initial adjustment for each range, and supplies flatness corrections for ac functions.

DC Zeros

DC Zeros is a quick, automatic process that corrects offset errors that increase with time on several output ranges. If a 5725A Amplifier is attached, it also zeros the 11 A dc range. This process takes approximately 2 ½ minutes (plus an additional 30 seconds for the 5725A).

Run DC Zeros

To execute dc zeros, from the normal operation screen:

1. Touch **Setup Menu** to show the Setup Menu. See the “Setup Menu” section of Chapter 4.
2. Touch the **Calibration** menu.

3. Touch **Run DC Zero** to start the dc zeros routine. The status of the dc zero calibration is shown as the Calibrator progresses through a series of steps. When completed, the Calibrator shows “Calibration complete”.

Note

If the Calibrator is not warmed up, the display prompts to continue or cancel the DC Zeros function.

4. Touch **Close** to proceed with Calibrator use.

DC Zeros Reminder

Specifications require that dc zeros be run at least every 30 days. If 30 days passes and dc zeros is not done, the display prompts to run the process.

To override the message and run dc zeros at a more convenient time, touch **Cancel**. To run dc zero at this time, touch **OK**.

Note

If this message shows after powering on the Calibrator, let the Calibrator warm up before running dc zeros. Otherwise an error message shows that indicates that the Calibrator is not warmed up. To ensure the best performance, the warmup should be completed.

Calibration

This section provides procedures to calibrate the Calibrator to external standards, adjust the range if necessary, and for do a calibration check.

In order to maintain traceability, these requirements must be met:

- Calibration to external standards must be completed at the start of the calibration cycle.
- Performance verification must be completed every two years.

Calibration Check and range calibration are optional procedures that are provided to enhance the accuracy if needed for special requirements. See “Calibration Check”.

Calibration Security Passcode

The integrity of Calibrator calibration is protected by a security passcode that must be entered before new calibration constants can be saved to non-volatile memory. This passcode replaces the hardware calibration switches found on older calibrators such as the Fluke 5720A. As with the 5720A, the passcode also protects the ability to set the date for the internal real-time clock.

If the passcode has not been entered, the Calibrator is secured. Once the passcode is entered, it is unsecured. The Calibrator secures itself when it is reset or when the setup menus are closed. The Calibrator can be unsecured at any time over the remote interface with the CAL_SECURE command and by entering the passcode. The front panel prompts for the passcode to unsecure the Calibrator before it can accept new values to be eventually secured.

The passcode contains 1 to 8 decimal digits. The Calibrator is shipped with the passcode set to "5730". To change the passcode, touch **Setup Menu>Calibration>Change Calibration Passcode**. The Calibrator prompts for the current passcode and then the new passcode. The passcode can also be changed over the remote interface with the CAL_PASSWD command.

If the passcode for a particular Calibrator is lost, contact Fluke Customer Support. See "How to Contact Fluke Calibration" in Chapter 1.

Artifact Calibration

The 5730A Calibrator must be calibrated to external standards at the beginning of the calibration cycle. The length of the cycle (24 hours, 90 days, 180 days, or one year) is selected in a Setup Menu described in Chapter 4.

To calibrate the Calibrator, apply three portable standards to the output binding posts:

1. 10 V dc voltage standard
2. 1 Ω resistance standard
3. 10 k Ω resistance standard

These standards are recommended:

- Model 732A or 732B DC Reference Standard
- Model 742A-1 1 Ω Resistance Standard
- Model 742A-10k 10 Ω Resistance Standard

Use 5440A-7003 (spade lugs) Low Thermal Leads for all connections:

Both the Calibrator and the recommended external standards have the ability to internally control (or compensate for) ambient temperature variations. Therefore, it is unnecessary to keep the Calibrator in tightly-controlled temperatures during calibration. During the calibration procedure, the Calibrator prompts for the ambient temperature, and includes this information in specification readouts and output shift reports.

Note

5440A-7002 and 5440A-7003 Low Thermal Lead sets include a third cable specifically designed for completing Artifact Calibration. The 5730A-7002 and 5730A-7003 Low Thermal Lead sets do not include the third cable for connection between reference standards.

When to Adjust Calibrator Accuracy

Table 7-3 lists each external uncertainty limit of the standards, and the Calibrator accuracy specifications that must be adjusted accordingly if that limit is exceeded.

As long as the external standards have the uncertainties listed in Table 7-3, when performing artifact calibration, it is not necessary to adjust the Calibrator absolute accuracy specifications in Chapter 1. However, if uncertainty of the in-house standard exceeds the value in the table, some of the absolute accuracy specifications of the Calibrator must be adjusted by the algebraic difference between the standard uncertainty and the uncertainty limit listed in the Table 7-3. For example, if the dc voltage standard has an uncertainty of ± 2.5 ppm, then the absolute uncertainty specifications listed in the Electrical Specifications tables above for dc volts, ac, volts, dc current, and ac current, must all be increased by ± 1 ppm.

Table 7-3. Standards for Calibration

Fluke Standard	Traceable Quantity	Nominal Value	Uncertainty Limit	Specifications susceptible to Uncertainty Limit
732B	Voltage	10 V	1.5 ppm	dc volts, ac volts, dc current, ac current
742A-1	Resistance	1 Ω	10 ppm	1 Ω , 1.9 Ω
742A-10k	Resistance	10 k Ω	2 ppm	ac current, dc current 10 Ω to 100 M Ω

Calibration Procedure

Before this procedure is started, make sure the 5730A Calibrator is powered on and has completed the appropriate warm-up period.

Follow this procedure to calibrate the main output functions:

1. Touch **Setup Menu>Calibration**. The calibration menu is shown.
2. If necessary, touch **Temperature** and enter the correct temperature (in degrees Celsius) to update the ambient temperature.
3. Touch **Run Artifact Cal** to begin the procedure. The Calibrator prompts the user to see the manual for the correct connections.
4. Connect the 732B to the Calibrator as shown in Figure 7-4.

16. If the largest shift is acceptable, touch **Save** to save the results, thus adjusting the Calibrator. If the security passcode has not already been entered, the Calibrator will prompt to do so before the results are saved. Touch **Discard** to discard the results from the calibration.

Range Adjustment

Once calibration is complete, it may be necessary to make further adjustments to the range. Range adjustment is accomplished by adjusting a range constant, which is an additional gain multiplier. Although range calibration is not needed in order to meet total uncertainty specifications, they are useful for tuning the 5730A Calibrator so that its values are closer to in-house standards.

Use an in-house laboratory standard to adjust the range constants. The subsequent procedure for adjusting the range constants is designed for laboratory standard values that are between 45 % and 95 % of the range's full-scale value.

Once the range constant is adjusted, the new constant remains active until the next calibration, at which time all range constant multipliers are restored to 1. All range adjustments can be erased by selecting **Restore Factory Defaults** from the Calibration Menu.

Before the subsequent procedure is started, make sure the equipment necessary including in-house laboratory standards where necessary, are on hand.

The subsequent example procedure adjusts the 220 V dc range constant with the listed equipment:

- 732B DC reference standard
- 752A Reference Divider
- Null Detector: Fluke Calibration 8508A 8.5 Digit Reference Multimeter
- Low Thermal Test Leads: 5440A-7003 (spade lugs)

Note

5440A-7002 and 5440A-7003 Low Thermal Lead sets include a third cable specifically designed for completing Artifact Calibration. The 5730A-7002 and 5730A-7003 Low Thermal Lead sets do not include the third cable for connection between reference standards.

Proceed as follows to adjust the 220 V dc range constant (the procedure is similar for all ranges). The calibration to external standards must be completed before this procedure is done.

1. Touch **Setup Menu>Calibration>Range Adjustment** to bring up the Range Adjustment menu shown below:

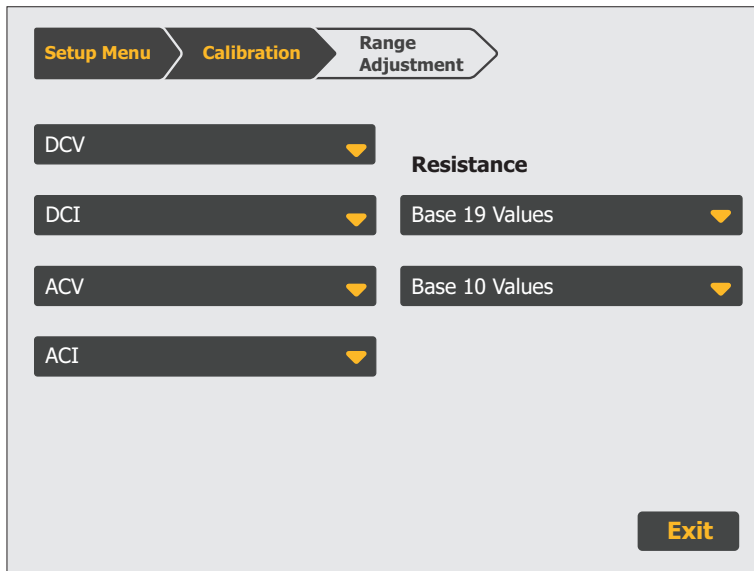

hhp189.eps

2. Touch **DCV** to show the next menu shown below:

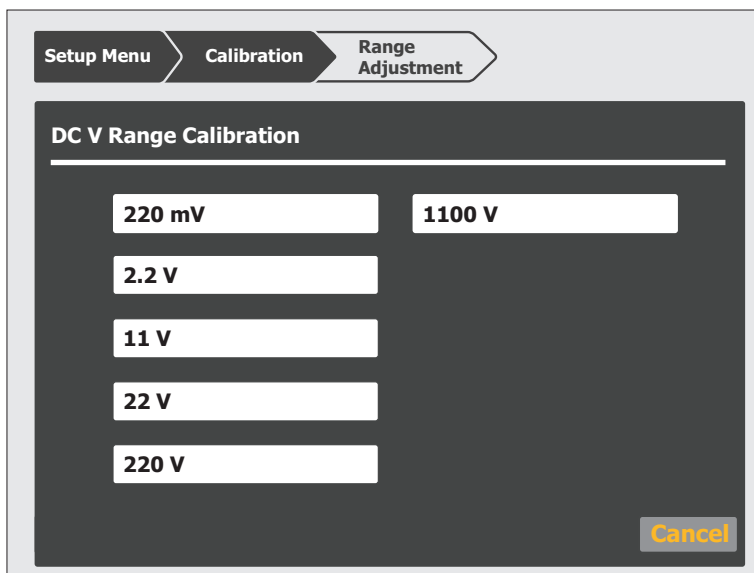

hhp190.eps

3. Touch **220 V** and this screen is shown:

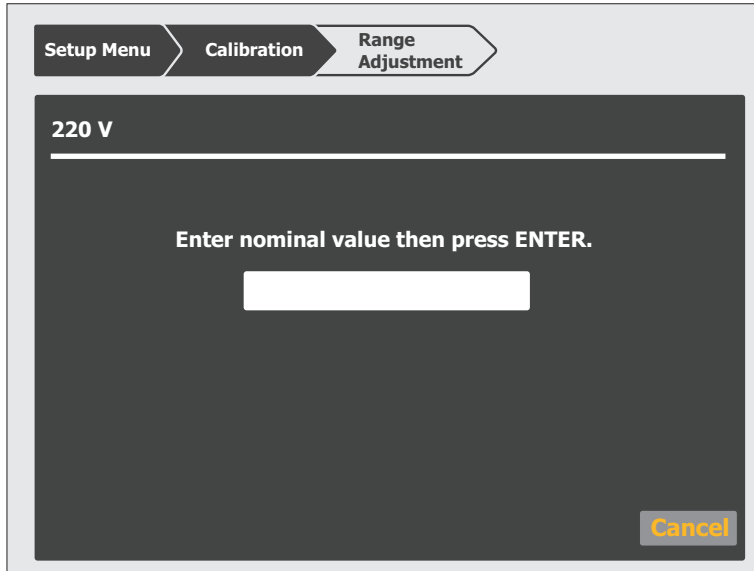

hhp216.eps

4. Connect the 732B, 8508A (Null Detector), and 752B in a 10:1 configuration, as shown in Figure 7-6.
5. Multiply the 732B value by 10, and enter this new value. The Calibrator output will be nulled to this new value.
6. Push **ENTER** to show this display:

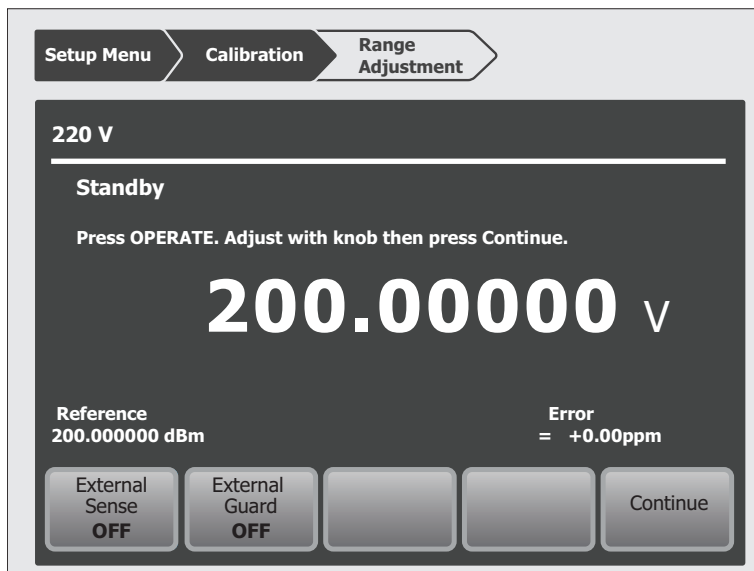

hhp217.eps

7. Push **OPERATE** to activate the Calibrator output. Turn the output adjustment knob on the Calibrator until a null is achieved on the null detector, and then touch **Continue**.
8. Touch **Save** to be prompted to enter the security passcode if the Calibrator has not been unsecured already. It then saves the new range adjustment for the 220 V dc range.
9. If **Discard** is touched, the result is discarded and the Range Calibration screen is shown.

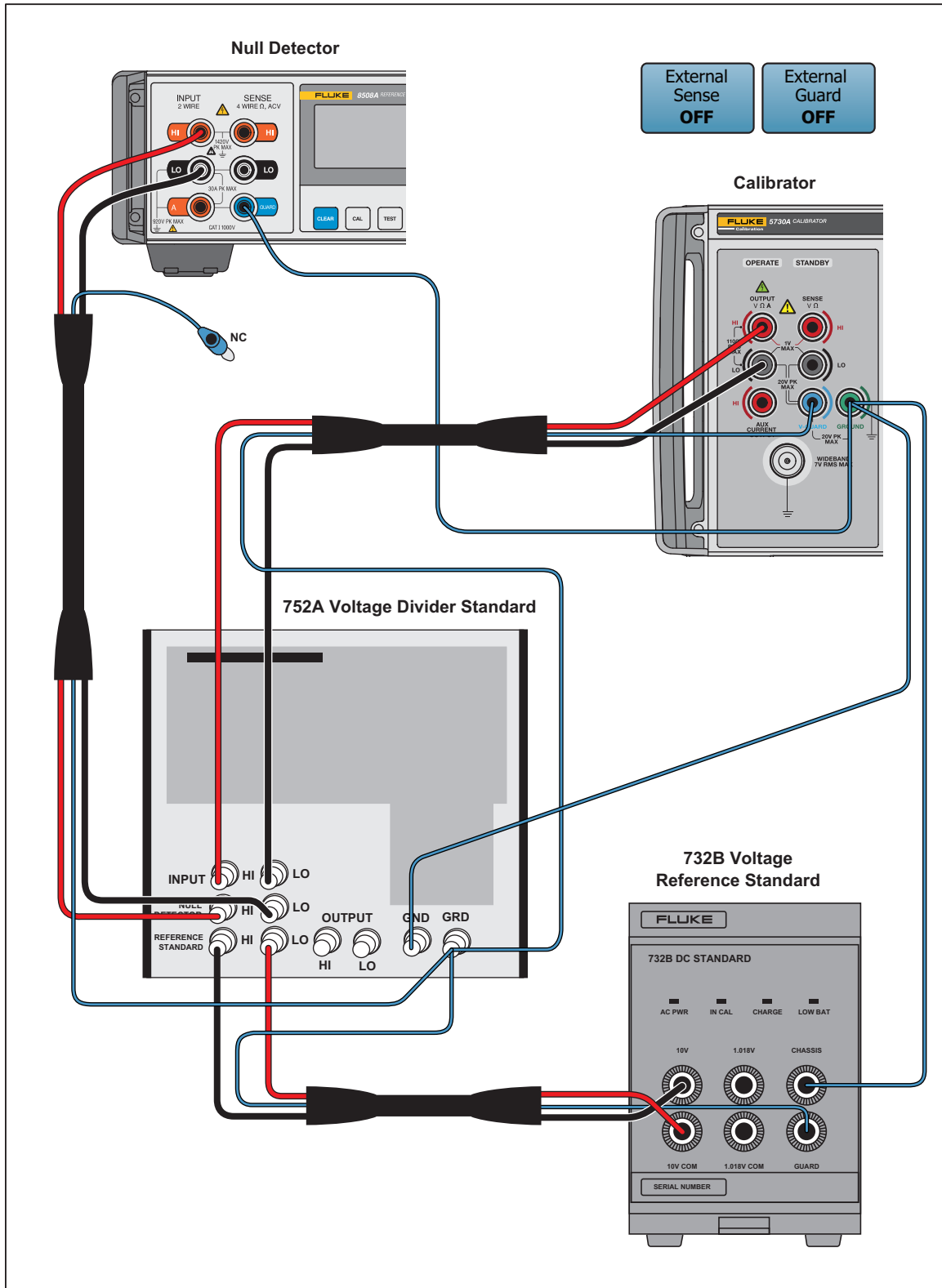

Figure 7-6. 220 V DC Range Calibration Connections

hhp029.eps

Calibrate the Wideband AC Module (Option 5730A/03 or 5730A/05)

The Wideband AC Module (Option 5730A/03 or 5730A/05) can be installed in the 5730A Calibrator. The module needs to be calibrated for both gain and flatness. The gain should be calibrated when the 5730A/03 or 5730A/05 main output functions undergo their routine calibration.

Since frequency flatness is determined by stable parameters (i.e. circuit geometry and dielectric constants), the flatness of the Wideband AC Module has excellent long-term stability. Consequently, a two-year calibration cycle is adequate for flatness calibration, and can be scheduled to coincide with the Calibrator shipment to a standards laboratory for periodic verification.

The subsequent procedure describes how to do the wideband gain calibration.

Note

To do this procedure, in addition to the standard equipment supplied with the wideband option, a Type “N” female to double banana plug adapter (e.g., Pomona 1740) is necessary.

Before this procedure is started, make sure the Calibrator is powered on and has completed an appropriate warm-up period. Then proceed with this procedure to calibrate the wideband gain.

1. Touch **Setup Menu>Calibration** to show the Calibration menu.
2. Connect the wideband output cable between the WIDEBAND connector and the SENSE binding post.

The center conductor of the 50 Ω feedthrough should go to SENSE HI as shown in Figure 7-7. The GND tab on the adapter should be on the LO side.

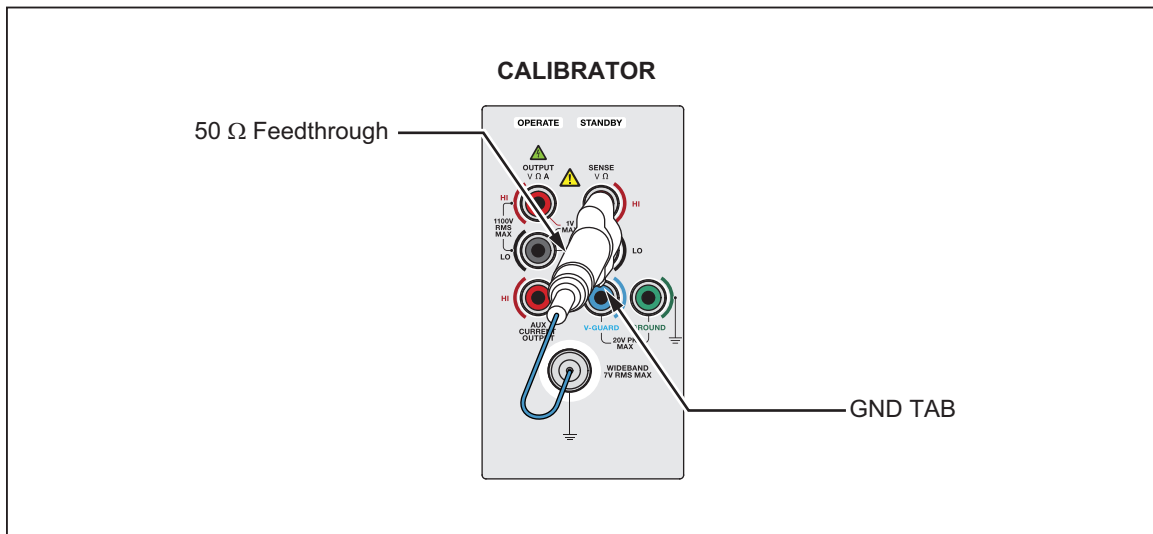

Figure 7-7. Wideband Module Calibration Connection

hhp030.eps

3. Touch **Run Wb Gain Cal** to begin calibration. The screen prompts the user to check the manual for the correct connections.
4. As the wideband calibration proceeds, messages are shown on the display identifying all processes as they are encountered. When positive gains calibration is complete, a message is shown to refer to the manual for negative gains connections.
5. Reverse the dual-banana connector so that the center connector is connected to LO.
6. Push **ENTER**. The display shows progress through the procedure in the same fashion as for artifact calibration. At the end of the procedure, the Calibrator gives the option to save or discard the results.
7. Touch **Save** to store the new calibration constants.
8. The Calibrator prompts for the security passcode if it has not already been entered. Enter the security passcode if it has not yet been entered.

Touch **Discard** to delete the results of the calibration. In both cases, the calibration screen is shown after the results are saved or deleted.

Wideband Flatness Calibration Procedure

This calibration procedure and the full verification of the 5730A Calibrator should be done every 2 years.

For flatness calibration:

1. Touch **Setup Menu>Calibration**. If the ambient temperature has changed from the displayed value, update it.
2. Touch **Run Wb Flatness Cal**.
3. Connect the equipment as shown in Figure 7-8.

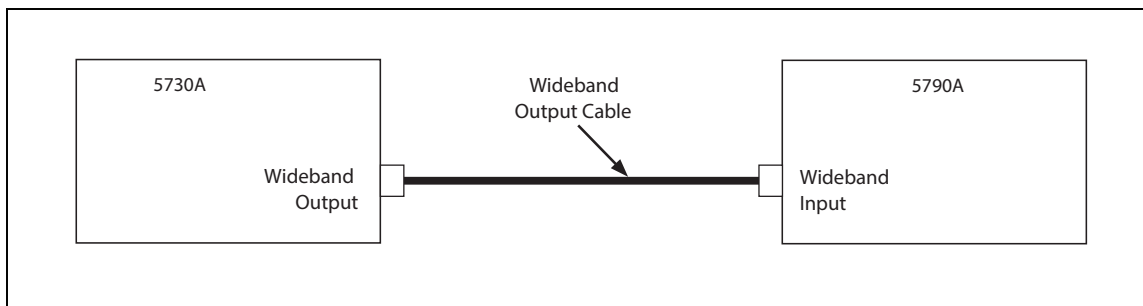
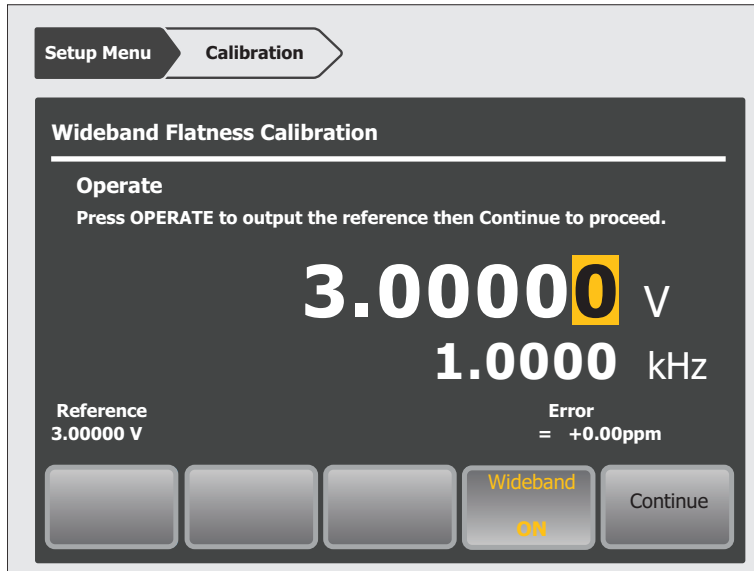

Figure 7-8. Wideband Flatness Calibration Connections

hhp313.eps

4. Touch **Continue**.



hhp221.eps

5. Push **OPERATE**. Wideband flatness calibration starts with a 3 V output at 1 kHz.
6. Push the SET REF soft key on the 5790A when the 5790A settles to a reading. This is the 3 V reference value from which all other frequencies will be compared.
7. Touch **Continue** and the frequency will go to the next value.

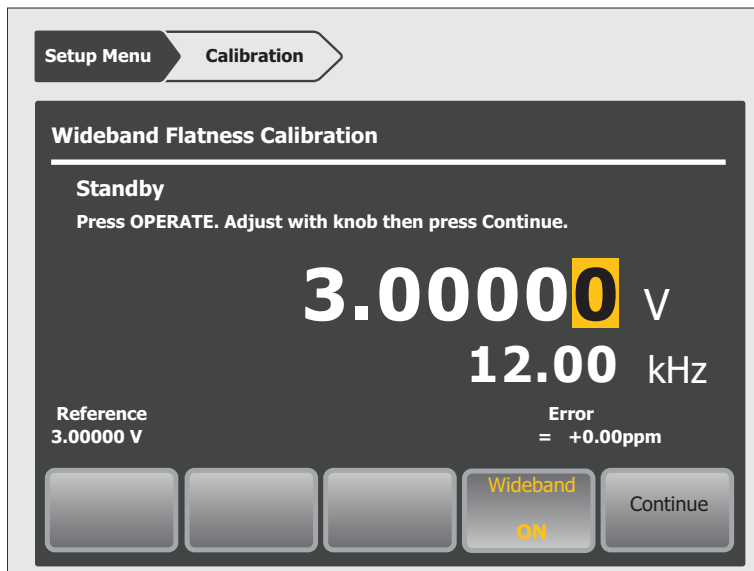

hhp222.eps

8. At this point and all subsequent points for this range, push OPERATE then adjust the Calibrator output adjustment knob to bring the 5790A error display to 0 and touch **Continue** on the Calibrator. Repeat this step for each frequency through 30 MHz (5730A/03 option) or MHz (5730A/05 option).

9. The Calibrator wideband output changes to 1 V at 1 kHz. When it has, push the CLEAR REF WBND soft key on the 5790A.
10. Repeat steps 7 to 10 for the 1 V, 300 mV, 100 mV, 30 mV, and 10 mV ranges.
11. Once the calibration procedure completes, save or discard the results in the same way as at the end of artifact calibration and wideband gain calibration.
12. Touch **Save** to store the new calibration constants.
13. The Calibrator prompts for the security passcode if it has not already been entered.
14. Touch **Discard** to delete the results of the calibration. In both cases, the calibration screen is shown after the Calibrator saves or deletes the results.

Calibration Check

A calibration check is similar to artifact calibration, with the primary differences being that no changes are made to the stored constants, and the internal check standards are used as the reference points. A calibration check produces a report similar to the normal calibration report, and shows output shifts that would result from using the results of the calibration check.

This procedure can be performed from an external computer, and can be set to run automatically, with no assistance (there is no need to enter the security passcode, since no constants are changed).

Use calibration check at any time to confirm the integrity of the 5730A Calibrator without connecting external standards. The calibration check is also useful for collecting a performance history.

Before this procedure is started, make sure the Calibrator is powered on and has completed the appropriate warm-up period. Then follow this procedure to check the calibration.

1. Touch the **Setup Menu>Calibration** to bring up the Calibration menu.
2. Touch **Run Calibration Check** to begin the procedure.
3. As the calibration check proceeds, the display indicates the current process of the calibration check. When the check is complete, the largest shift that is detected appears on the display. The Calibrator tells when calibration is complete.
4. Touch **Continue** to return to the Calibration menu. A report of the output shifts can be saved from this menu.

Develop a Performance History

A Fluke Calibration specification is a set of performance limits that all products must meet. To maintain consistent quality, Fluke calibrators are specified with enough margin to include temperature, line, and load extremes, plus additional margin for production. This means that a typical Calibrator in a typical environment operates inside 50 % of specification limits. For some exacting applications, it can be helpful to know just how accurately a particular Calibrator operates. The proper way to do this is to accumulate a performance history by calibrating regularly and recording results on a control chart.

Calibrating regularly and recording the results on a control chart is tedious and requires a large array of equipment. The Calibrator calibration check feature is an alternative with some distinct advantages:

- Calibrated check standards are already programmed into the unit. External standards are not necessary.
- The process is consistent and automatic and it does not require operator assistance.

Each calibration check produces a new set of data points for accumulating a historical record. When this process is externally automated, significant history can be accumulated much faster than with a manual calibration.

Save Calibration Reports

Calibration reports can be created and exported to a USB flash drive from the Calibrator Calibration Report menu. The subsequent sections describe the reports.

To save a calibration report:

1. Put a flash drive into the front USB port.
2. Go to **Setup Menu>Calibration>Generate Report**.
3. Select one of the three reports:
 - Save Calibration Shifts
 - Save Check Shifts
 - Save Raw Data

Once an item is selected, the report is loaded to a USB flash drive. The report is in comma separated value (CSV) format and is capable of being imported into a spreadsheet program such as Microsoft Excel.

4. Open or print the file from the PC.

Calibration Shift Results

The Calibration Shift report presents all adjustments made to stored zero-offset and gain constants, as a result of any drift detected at the most recent calibration. This report is available and valid at any time.

The report contains this information:

- Heading containing the date and time the report was saved, the user report string, and the installed version of the Calibrator software.
- Modules present (installed or attached) including any attached amplifiers
- Most recent calibration dates and temperatures
- Values of externally-calibrated internal references including the resistance reference, which is the average of the actual-to-nominal ratios of the 100 Ω , 190 Ω , 1 k Ω , 1.9 k Ω , 10 k Ω , 19 k Ω , 100 k Ω , and 190 k Ω resistors.
- DC voltage output shifts for each range
- AC voltage output shifts for each range. A gain shift for all frequencies is shown along with shifts at selected frequencies for each range.
- Current output shifts for each range (ac and dc)
- Resistance shifts for each value
- 5725A Amplifier output shifts (if attached)
- Wideband AC Module (Option 5730A/03 or 5730A/05) output shifts (if installed)

The shifts of references and outputs are given both as absolute shifts in V, A, or ohms, and also (for non-zero magnitudes) as shifts relative to the previous value, in parts per million (ppm) or percent (%).

The specified accuracy for the output is also shown, and the ratio of the shift to that accuracy in percent.

The Calibration Shift report file name is CSyymmdd.CSV, where yymmdd is the date today. For example, a calibration shift report compiled on October 28, 2013 would be saved to CS131028.CSV.

Calibration Check Shift Results

The Calibration Check report presents changes in the magnitude of self-correction generated by calibration check. Calibration check uses internal standards rather than external standards as the basis for comparison, and does not make permanent changes to calibration constants. This report is available only after a calibration check has been performed and until the Calibrator is reset. The report contains the subsequent information, and is shown below:

- Heading that shows the date and time the report was saved and user report string
- Modules present (installed or attached)
- Most recent calibration dates and temperatures
- Values of externally-calibrated internal references
- DC voltage output shifts for each range
- AC voltage output shifts for each range
- AC and dc current output shifts for each range
- Resistance shifts for each value
- 5725A Boost Amplifier output shifts (if attached). The calibration report file name is CKyymmdd.CSV, where yymmdd is the date today.

Raw Data Results

This report gives the values for the internally stored correction factors (calibration constants), and is useful primarily for our service centers.

Chapter 8

Options and Accessories

Introduction

This chapter describes options and accessories available to enhance the capabilities of the 5730A Calibrator. Chapter 4 contains instructions for operation of the Calibrator with the options and accessories described here. To order options or accessories, call or write to a Fluke Calibration Service Center.

Wideband AC Voltage Module (Option 5730A/03 or 5730A/05)

The Wideband AC Voltage Module (Option 5730A/03 or 5730A/05) is used to calibrate RF voltmeters, and can be installed in the Calibrator. The Module frequencies range from 10 Hz to 30 MHz (5730A/03) or 50 MHz (5730A/05). It is a highly accurate, low-noise, ac voltage source that maintains excellent flatness. The module sources its output through a coaxial connector into a 50 Ω load, and this output can be from within any of seven ranges of values, from 300 μ V (-57 dBm) to 3.5 V (+24 dBm), selected in either volts or dBm.

The wideband module also functions with the Calibrator edit controls. This will let the display show the error of a wideband meter in percentage of output or decibels.

Accessories

Included with the wideband module are a Type “N” output cable, 50 Ω terminator, an N(f) to BNC(m) adapter, and a BNC(f) to double banana plug adapter. The wideband module is calibrated to the end of its standard equipment output cable.

Table 8-1 summarizes the accessories available for the Calibrator. After the table is a brief description of each accessory.

Table 8-1. Accessories

Model	Description
732B	DC Voltage Reference Standard
742A-1	1 Ω Resistance Transfer Standard
742A-10k	10 k Ω Resistance Transfer Standard
5440A-7003	Low Thermal EMF Test Lead Set with Spade Lugs. Two 4 ft. (122 cm) cables and One 2 ft. (61 cm) cable.
5440A-7002	Low Thermal Test Lead cables with banana plugs.
5730A-7002	Low Thermal Test Lead cables with banana plugs.
5730A-7003	Low Thermal Test Lead cables with spade lugs.
Y8021	IEEE-488 Shielded Interface Cable, 1 Meter
Y8022	IEEE-488 Shielded Interface Cable, 2 Meters
Y5737	24 in (61 cm) Rack Mount Kit
Y5735	24 in (61 cm) Rack Mount Kit for 5725A
Y5738	Rack Ear Kit
5730A/03	30 MHz Wideband AC Voltage option
5730A/05	50 MHz Wideband AC Voltage option

Low Thermal EMF Test Leads

Four types of low thermal test leads are available. These cables are designed to exhibit low thermal emfs. The available types are:

- Model 5440A-7002. Low Thermal Test Lead cables with banana plugs.
Set includes one 4 ft. (122 cm) cable and two 2 ft. (61 cm) cables. Each cable includes two conductors and a shield lead.
- Model 5440A-7003. Low Thermal Test Lead cables with spade lugs.
Set includes one 4 ft. (122 cm) cables and two 2 ft. (61 cm) cable. Each cable includes two conductors and a shield lead. Shield lead has a banana plug connector.
- Model 5730A-7002. Low Thermal Test Lead cables with banana plugs. Set includes two 4 ft. (122 cm) cables. Each cable includes two conductors and a shield lead.
- Model 5730A-7003. Low Thermal Test Lead cables with spade lugs. Set includes two 4 ft. (122 cm) cables. Each cable includes two conductors and a shield lead. Shield lead has a banana connector.

Rack Mount Kits

The rack mount kits provide all the hardware necessary to mount the Calibrator and the 5725A Amplifier on slides in a 24 inch (61 cm) equipment rack. Model Y5737 is for the 5730A and Model Y5735 is for the 5725A. The Y5738 includes the Rack Ears and fasteners without the slide rack mount. Instructions are included with each kit.

Shielded IEEE-488 Interface Cables (Y8021 and Y8022)

Shielded IEEE-488 cables are available in two lengths (see Table 8-1). The cables attach the Calibrator to any other IEEE-488 device. Each cable has double 24-pin connectors at both ends to allow stacking. Metric threaded mounting screws are provided with each connector. Figure 5-1 in Chapter 5 shows the pinout for the IEEE-488 connector.

DC Voltage Reference Standard (732B)

The Fluke 732B is a rugged, easily transported solid state direct voltage reference standard with a highly predictable 10 V output. This predictability allows the Fluke Standards Laboratory, as well as many Fluke customers, to completely eliminate fragile, saturated standard cells. Many laboratories that maintain standard cells use the 732B as a transportable voltage standard, eliminating the need to transport their standard cells. The 732B can be short circuited, even for extended periods of time, without damage or loss of stability. The 732B maintains full specified stability over a temperature span of 18 °C to 28 °C.

The Calibrator uses a 10 V reference standard such as the Fluke 732B in an automated menu-prompted procedure to establish voltage traceability. Chapter 7 describes this procedure.

1 Ω and 10 k Ω Resistance Standards (742A-1 and 742A-10k)

The 742A Series Standard Resistors are available in values of 1 Ω and 10 k Ω to support the Calibrator. Constructed of arrays of Fluke wirewound precision resistors, these standards are ideally suited as support standards for the Calibrator. Stability of the resistance transfer standards and their temperature coefficient make them ideal for easy transport to and operation in the Calibrator working environment.

The Calibrator uses 1 Ω and 10 k Ω resistor standards such as the 742A Series in its automated calibration procedure to establish external traceability. Chapter 7 describes this procedure.

5725A Amplifier

The Fluke 5725A Amplifier is an external unit that operates under Calibrator control to extend ac voltage drive capabilities and both ac and dc current output range. The amplifier adds the following capabilities to the Calibrator 1100 V ac range with no compromise in accuracy:

- Frequency limits at higher voltage increase to 100 kHz at 750 V, 30 kHz at 1100V.
- Load limit increases to 70 mA for frequencies above 5 kHz.
- Capacitive drive increases to 1000 pF, subject to the maximum output current.

A separate set of binding posts on the front panel of the 5725A supplies extended-range ac and dc current outputs. Since most meters have a separate input terminal for the high current ranges, this eliminates the need to change cables during a procedure. A Calibrator paired with a 5725A can also be configured to source all current (both standard Calibrator-generated outputs and its own outputs) through the 5725A binding posts.

An interface connector on the Calibrator rear panel accepts the cable to directly operate a 5725A. Once the amplifier has been connected and the 5725A has been configured in a setup menu, operation is controlled by the Calibrator.

Chapter 4 provides instructions for operating the 5725A amplifier. The general specifications at the end of Chapter 1 include specifications for operating the 5730A Calibrator with the 5725A. For other amplifier specifications, refer to their instruction manuals. Table 1-1 summarizes the extended capabilities offered by each amplifier. Brief descriptions of the extended capabilities follow.

52120A Amplifier

The 52120A is available to extend the current range of the Calibrator.

An interface connector on the Calibrator rear panel accepts the cable to directly operate one or more 52120As in slave mode.

See Chapter 4 for operation instructions for the 52120A Transconductance Amplifier. The general specifications at the end of Chapter 1 include specifications for operating the Calibrator with one or more 52120As.

Appendix A

Fault Codes

0-Level Faults: Firmware Updater	
1	Backup directory not specified in AuxInfo
2	Backup filename not specified in AuxInfo
3	Destination directory not specified in AuxInfo
4	Destination filename not specified in AuxInfo
5	Error extracting required file transfer data from AuxInfo
6	Error retrieving parameter value from AuxInfo
7	Error retrieving section name from AuxInfo
8	Interim directory not specified in AuxInfo
9	Interim filename not specified in AuxInfo
10	Error reading AuxInfo file
11	Source directory on USB device not specified in AuxInfo
12	Source filename on USB device not specified in AuxInfo
13	Cannot build a list of sequences to be executed
14	Backup directory not specified in AuxInfo (config/cal)
15	Backup file not specified in AuxInfo (config/cal)
16	Destination directory not specified in AuxInfo (config/cal)
17	Destination file not specified in AuxInfo (config/cal)
18	Source directory not specified in AuxInfo (config/cal)
19	Source file not specified in AuxInfo(config/cal)
20	Error setting mode of new file
21	Timestamp too long in AuxInfo
22	Cannot close updated file (config/cal)
23	Destination file does not exist (config/cal)

24	Cannot get required AuxInfo parameters (config/cal)
25	Cannot open new file (config/cal)
26	Failed to read the existing (destination) file (config/cal)
27	Failed to read the new (source) file (config/cal)
28	Cannot remove existing backup file (config/cal)
29	Cannot rename existing file to backup file (config/cal)
30	Source file does not exist (config/cal)
31	Invalid timestamp. Cannot convert to epoch time
32	Kernel Datapath1 not specified in AuxInfo
33	Kernel Datapath2 not specified in AuxInfo
34	Kernel Device not specified in AuxInfo
35	Kernel Erase Command not specified in AuxInfo
36	Cannot extract Kernel update data from AuxInfo
37	Kernel Offset not specified in AuxInfo
38	Kernel Read Command not specified in AuxInfo
39	Kernel Write Command not specified in AuxInfo
40	Kernel Device failed to close
41	Kernel Device failed to return info about device status
42	Kernel Device failed to open
43	Kernel Device failed to return status (error not used).
44	Unable to determine the size of the Kernel image file
45	Invalid offset in Kernel image section
46	Unable to extract command1 from AuxInfo for FrontPanel_Part3
47	Unable to extract command2 from AuxInfo for FrontPanel_Part3
48	Error creating interim directory
49	MD5 hash of downloaded file does not agree with AuxInfo
50	Error mounting USB device
51	File to be downloaded does not exist on USB device
52	USB device not plugged in
53	Error deleting previous backup file
54	Error renaming installed file to backup
55	Error moving download file to destination directory
56	Remove file operation not specified in AuxInfo
57	Remove file operation failed
58	Error copying file from USB device to interim directory

59	File on USB device is older than installed file
60	File on USB device same as installed file (per timestamp)
61	Error unmounting USB device
62	Cannot extract ver # from line 1 of src file (config/cal)
63	Cannot extract ver # from line 1 of dest file (config/cal)
64	Kernel Datapath1 MD5 hash failed
65	Kernel Datapath2 (readback) MD5 hash failed

100-Level Faults: System	
100	Low airflow
101	Cannot modify file property
102	Update execution error
103	Cannot open gpio PORT_A

200-Level Faults: 5725 Boost	
200	5725 No Error
201	5725 Self-Test ROM Failure
202	5725 Self-Test RAM Failure
203	5725 Self-Test EEPROM Failure
204	5725 Self-Test Data Bus Failure
205	5725 Self-Test CLAMPS Circuit Failure
206	5725 Self-Test HVCLR Circuit Failure
207	5725 Self-Test DAC Failure
208	5725 Self-Test Watchdog Timer Failure
209	5725 Current Heatsink Too Hot
210	Output Tripped To Standby
211	5725 Current Compliance Voltage Too High
212	5725 Current Compliance Voltage Too High
213	5725 +400 V Supply Did Not Shut Off
214	5725 -400 V Supply Did Not Shut Off
215	5725 Voltage Heatsink Too Hot
216	5725 Voltage Heatsink Too Hot
217	5725 +400 V Supply Too Small
218	5725 +400 V Supply Too Large
219	5725 -400 V Supply Too Large

220	5725 -400 V Supply Too Small
221	5725 +400 V Supply Current Too High
222	Output Tripped To Standby
223	5725 -400 V Supply Current Too High
224	Output Tripped To Standby
225	5725 Fan Not Working
226	5725 CLAMPS Fault
227	Output Tripped To Standby
228	5725 Software TRAP
229	5725 Cable Was Off
230	5725 RESET (power-up or watchdog timer)
231	5725 Guard-Crossing Timeout
232	5725 Illegal/Unexecutable Command
233	5725 Non-Maskable Interrupt Occurred
234	5725 HVCLEAR Circuit Activated
235	Output Tripped To Standby

400-Level Faults: Calibration Constant	
---	--

400	Bad Cal Constant ID
-----	---------------------

500-Level Faults: Configuration Finder	
---	--

500	Bad Mode To CNFmodeRanges
501	Configuration Table Overflow
502	Bad Amplifier Type Selection
503	Bad Flat Constant Type Selection
504	Guard Crossing Error While Polling Assemblies
505	5725 Guard Crossing would not Start

700-Level Faults: Error Handling	
---	--

700	Error Queue Overflow
701	Bad ERR Channel

800-Level Faults: Executive	
800	Wideband Module Needed
801	Amplifier Not Selected or Connected
802	Amplifier Must Remain On For This Output
803	Over Limits Of Locked Range
804	Under Limits Of Locked Range
806	Invalid Date
807	Invalid Time
808	DC dBm Not Allowed
809	Ext Ref Value Out Of Range
810	Bad Edit Digit Movement
811	Not Wideband Units
812	Cannot Set Frequency With Ohms
813	Bad Units
814	Wrong Polarity For Limit
815	Outside Entry Limits
816	Magnitude Too Large For Calibrator
817	Magnitude Too Small For Calibrator
818	Frequency Too Large For Calibrator
819	Frequency Too Small For Calibrator
820	Calibrator Cannot Source That Value
821	V Limit Outside Calibrator Ability
822	I Limit Outside Calibrator Ability
823	Cannot Adjust Frequency To ≤ 0 Hz
824	Offset Not Allowed Now
825	Scale Not Allowed Now
826	Ohms Reading Set Too High
827	Ohms Reading Set Too Low
828	Cannot Use External Sense Now
829	Cannot Use Phase Shift Now
830	Cannot Use Phase Lock Now
831	Cannot Use 2-Wire Comp Now
832	Could not Do Default Wideband Output
833	Bad Selector For Set/Get Item
834	Cannot Boost This Output Mode

835	Cannot Use Ext Sense On Selected Range
836	Cannot Use 2-Wire Comp On Selected Range
837	Cannot Lock This Range
838	Cannot Set Clock, Cal Is Secured
839	Cannot Fmt EEPROM, Cal Is Secured
840	Illegal Output Post For Current
841	No Boost Available For Selected Output
842	Not A Valid Wideband Flatness Point
843	Wideband Flatness Cal Is Not Active
844	Report String Too Long
845	Cannot Store, Cal Is Secured
846	Range Calibration Is Not Active
847	Magnitude Too High For Range Cal
848	Magnitude Too Low For Range Cal
849	Invalid Calibrator Setup Block
850	Cannot Format, 5725 Switch In NORMAL
851	Cannot Store, 5725 Switch In NORMAL
852	Calibration Steps Out Of Order
853	Cannot Use External Guard Now
854	Cannot Use Ext Guard On Selected Range
855	Cannot Set String, Cal Is Secured
856	Present Output Exceeds Selected Limit
857	Bad Selector For Reference Calibration
858	Cannot Change Range Now
859	Hardware Not Installed For This Range
860	Cannot Use Amplifier For This Output
861	5725 Cannot Ext Sense At That Frequency
862	Change To HI Outputs For 120 A Range

1000-Level Faults: 5725 Communication Receive	
1000	Could not ACK Packet From 5725
1001	Illegal 5725 Receive Task State
1002	Bad Receive Packet Number From 5725
1003	Bad Control Byte From 5725

1100-Level Faults: 5725 Communication Transmit	
1100	Multiple Timeouts Sending To 5725
1101	5725 RQR Loop
1102	Unexpected NSA From 5725
1103	Bad Packet Number In ACK From 5725
1104	Bad Control Byte From 5725 Receive Task
1105	Illegal 5725 Transmit Task State
1106	5725 Indefinite ACKWAIT Holdoff

1200-Level Faults: 5725 Communication Utility	
1200	Serial Write Failure To 5725
1201	Packet Too Large For 5725

1300-Level Faults: Output Monitor	
1301	Output Tripped To Standby
1302	Output Tripped To Standby
1303	DC Zero Is Needed (Every 30 Days)

1400-Level Faults: Software Timer	
1400	Cannot Install MTtick()
1401	Bad Timer Selector

1500-Level Faults: Guard Crossing Receive	
1500	Could not ACK Packet From Inguard
1501	Illegal Inguard Receive Task State
1502	Bad Receive Packet Number From Inguard
1503	Bad Control Byte From Inguard

1600-Level Faults: Guard Crossing Transmit	
1600	Multiple Timeouts Sending To Inguard
1601	Inguard Request Reset Loop
1602	Unexpected NSA From Inguard
1603	Bad Packet Number In ACK From Inguard
1604	Bad Control Byte From Inguard Rcv Task
1605	Illegal Inguard Transmit Task State
1606	Inguard Indefinite ACKWAIT Holdoff

1700-Level Faults: Guard Crossing Utility	
1700	Serial Write Failure To Inguard
1701	Packet Too Large For Inguard

1800-Level Faults: Normal Output Operations	
1800	DORMANT To OPERATE
1801	Bad Transition Type
1802	Bad Boolean Selector
1803	NRMrngStby Encountered Error
1804	DCV Called For Non-DCV Range
1805	ACV Called For Non-ACV Range
1806	Bad ACV Frequency Range
1807	Hi Res Frequency Too High
1808	ACV Amplitude Correction Failure
1809	Cannot Phase Lock To Signal
1810	Bad Phase Quadrant
1811	Current Called for Non-Current Range
1812	Ohms Called for Non-Ohms Range
1813	Cannot Phase Lock, Output Not AC
1814	Cannot Phase Shift, Output Not AC
1815	Bad Wide Band Range
1816	Frequency Too High Even For Wide Band
1817	Illegal Current Output Location
1818	Output Current Out Of Tolerance
1819	Current Compliance Voltage Exceeded
1820	2-Wire Compensation Current Exceeded

1821	NRMbstcur Passed Bad Range
1826	5725 No Longer Connected
1827	14-Bit DAC Scaling Found Zero Output

1900-Level Faults: Non-volatile	
1900	Repaired Missing Or Corrupted NV Files
1903	Unknown Nonvolatile Constant Selector
1905	Could Not Write Byte To 5725 EEPROM
1906	Checksum Error Reading 5725 EEPROM

2000-Level Faults: Analog Operations Manager	
2000	Bad Command Code
2001	Bad Signal
2002	Long Term Command In Progress
2003	Guard Crossing Protocol Failed To Start
2004	Fatal Fault, Output Tripped

2200-Level Faults: Remote Interface	
2200	Unknown Command
2201	Invalid Number Of Parameters
2202	Invalid Cal Constant Name
2203	Invalid Keyword
2204	Invalid Range
2205	Invalid Parameter Type
2206	Invalid Parameter Unit
2207	Invalid Parameter Value
2208	IEEE488.2 I/O DEADLOCK
2210	IEEE488.2 INTERRUPTED Query
2211	Not Allowed From GPIB Interface
2212	Not Allowed From Serial Interface
2213	Remote Only
2214	Invalid Syntax
2215	IEEE488.2 UNTERMINATED Command
2216	Symbol Table Overflow
2218	Invalid Binary Number

2219	Invalid Binary Block
2220	Invalid Character
2221	Invalid Decimal Number
2222	Invalid Hexadecimal Block
2223	Invalid Hexadecimal Number
2224	Too Many Parameters
2225	Invalid Octal Number
2226	Too Many Characters
2227	Invalid String
2228	Invalid Register Address
2229	Invalid Cal Constant Name
2230	Remote Serial Port Dead
2231	IEEE488.2 Query After Indef Response
2232	OPER Not Allowed While Fault Pending

2300-Level Faults: Report Generation	
---	--

2300	Unknown Report Requested
2301	Unknown Report Device Requested
2302	Serial Port Timeout
2303	Could not find USB drive
2304	Could not open report file on USB drive

2400-Level Faults: Real Time Clock	
---	--

2400	Could not read time and date.
2401	Could not set time and date.

2500-Level Faults: Self Calibration	
--	--

2500	Invalid Cal Procedure Number
2501	Could not Ext Cal Gain
2502	Could not Ext Cal Ref
2503	Could not Ext Cal Neg
2504	Could not Cal Ratio
2505	Could not Cal Pos 11 V or 22 V DC Zero
2506	Could not Cal Neg 11 V or 22 V DC Zero
2507	Could not Cal Pos 11 V or 22 V DC Gain
2508	Could not Cal 6.5 V or 13 V Buf Ref

2509	Could not Cal 2.2 V Zero
2510	Could not Cal 220 mV Gain S1
2511	Could not Cal 220 mV Gain S2
2512	Could not Cal 220 mV Gain S3
2513	Could not Cal 220 mV Gain S4
2514	Could not Cal 220 V DC Offset
2515	Could not Cal 220 V DC Rnet
2516	Could not Cal 220 V DC Gain
2517	Could not Cal ACV Gain
2518	Flatness Cal: Main Sensor Fail?
2519	Flatness Cal: AC Cal Sensor Fail?
2520	Could not Cal Fine Tune (14 bit) DAC
2521	Could not Cal Fine Tune 15th bit Down
2522	Could not Cal Fine Tune 15th bit Up
2523	Could not Cal 2.2 mV/22 mV step 1
2524	Could not Cal 2.2 mV/22 mV step 2
2525	Could not Cal 220 V AC Offset
2526	Could not Cal 220 V AC Gain
2527	Could not Cal 220 mV Offset
2528	Could not Cal 1100 V AC/DC Offset
2529	Could not Cal 1100 V AC/DC Gain
2530	Could not Cal 220 μ A DC Zero
2531	Could not Cal 2.2 mA DC Zero
2532	Could not Cal 22 mA DC Zero
2533	Could not Cal 220 mA DC Zero
2534	Could not Cal 2.2 A DC Zero
2535	Could not Cal 220 μ A DCI (Meas 1)
2536	Could not Cal 220 μ A DCI (Meas 2)
2537	Could not Cal 2.2 mA DCI (Meas 1)
2538	Could not Cal 2.2 mA DCI (Meas 2)
2539	Could not Cal 22 mA DCI (Meas 1)
2540	Could not Cal 22 mA DCI (Meas 2)
2541	Could not Cal 220 mA DCI (Meas 1)
2542	Could not Cal 220 mA DCI (Meas 2)
2543	Could not Cal 2.2 A DCI (Meas 1)

2544	Could not Cal 2.2 A DCI (Meas 2)
2545	Could not Ext Cal 10 K Ω Std (Meas 1)
2546	Could not Ext Cal 10 K Ω Std (Meas 2)
2547	Could not Ext Cal 10 K Ω Std (Meas 3)
2548	Could not Cal 10 K Ω (Meas 1)
2549	Could not Cal 10 K Ω (Meas 2)
2550	Could not Cal 10 K Ω (Meas 3)
2551	Could not Cal 19 K Ω (Meas 1)
2552	Could not Cal 19 K Ω (Meas 2)
2553	Could not Cal 19 K Ω (Meas 3)
2554	Could not Cal 100 K Ω (Meas 1)
2555	Could not Cal 100 K Ω (Meas 2)
2556	Could not Cal 190 K Ω (Meas 1)
2557	Could not Cal 190K Ω (Meas 2)
2558	Could not Cal 1 M Ω (Meas 1)
2559	Could not Cal 1 M Ω (Meas 2)
2560	Could not Cal 1.9 M Ω (Meas 1)
2561	Could not Cal 1.9 M Ω (Meas 2)
2562	Could not Cal 10 M Ω (Meas 1)
2563	Could not Cal 10 M Ω (Meas 2)
2564	Could not Cal 19 M Ω (Meas 1)
2565	Could not Cal 19 M Ω (Meas 2)
2566	Could not Cal 100 M Ω (Meas 1)
2567	Could not Cal 1 K Ω (Meas 1)
2568	Could not Cal 1 K Ω (Meas 2)
2569	Could not Cal 1.9 K Ω (Meas 1)
2570	Could not Cal 1.9 K Ω (Meas 2)
2571	Could not Cal 100 Ω (Meas 1)
2572	Could not Cal 100 Ω (Meas 2)
2573	Could not Cal 190 Ω (Meas 1)
2574	Could not Cal 190 Ω (Meas 2)
2575	Could not Cal Ohms Divider (Meas 1)
2576	Could not Cal Ohms Divider (Meas 2)
2577	Could not Cal 10 Ω Ω (Meas 1)
2578	Could not Cal 10 Ω (Meas 2)

2579	Could not Cal 19 Ω (Meas 1)
2580	Could not Cal 19 Ω (Meas 2)
2581	Could not Ext Cal 1 Ω (0.26V CM Meas)
2582	Could not Ext Cal 1 Ω (Ext Meas)
2583	Could not Ext Cal 1 Ω (0.13V CM Meas)
2584	Could not Ext Cal 1 Ω (Int Meas)
2585	Could not Ext Cal 1.9 Ω (0.18V CM Meas)
2586	Could not Ext Cal 1.9 Ω (0.12V CM Meas)
2587	Could not Ext Cal 1.9 Ω (Int Meas)
2588	Could not Cal Wideband Gain
2589	Bad Cal Step Selector
2590	A/D Appears To Have Failed
2591	User Range Gain Adjustment Is 0
2592	Stored User Range Gain Adjust Is 0
2593	220 μ A AC Flatness Calibration Failed
2594	2.2 mA AC Flatness Calibration Failed
2595	22 mA AC Flatness Calibration Failed
2596	220 mA AC Flatness Calibration Failed
2597	Bad Range Number For IAC Flatness Cal
2598	No Data For DCI Calibration
2599	2.2 V AC Flat Early Fail
2600	2.2 V AC Flat Bad AC Cal Sensor?
2601	2.2 V AC Flat Diverge
2602	22 V AC Flat Early Fail
2603	22 V AC Flat Bad AC Cal Sensor?
2604	22 V AC Flat Diverge
2605	220 V AC Flat Early Fail
2606	220 V AC Flat Bad AC Cal Sensor?
2607	220 V AC Flat Diverge
2608	1100 V AC Flat Early Fail
2609	1100 V AC Flat Bad AC Cal Sensor?
2610	1100 V AC Flat Diverge
2611	220 μ A IAC Flat Early Fail
2612	220 μ A IAC Flat Bad AC Cal Sensor?
2613	220 μ A IAC Flat Diverge

2614	2.2 mA IAC Flat Early Fail
2615	2.2 mA IAC Flat Bad AC Cal Sensor?
2616	2.2 mA IAC Flat Diverge
2617	22 mA IAC Flat Early Fail
2618	22 mA IAC Flat Bad AC Cal Sensor?
2619	22 mA IAC Flat Diverge
2620	220 mA IAC Flat Early Fail
2621	220 mA IAC Flat Bad AC Cal Sensor?
2622	220 mA IAC Flat Diverge
2623	2.2 A IAC Flat Early Fail
2624	2.2 A IAC Flat Bad AC Cal Sensor?
2625	2.2 A IAC Flat Diverge
2626	Illegal Ohms Null Function State
2627	Unknown Source Divider Identifier
2628	No Data For Ohms Calibration
2629	Illegal Ohms Calibration Config
2630	Illegal Number Of Ohms Cal Points
2631	5725 Shunt 0 A Meas Fail
2632	5725 Shunt 1.3 A Meas Fail
2633	5725 Current Amplifier Zero Meas Fail
2634	5725 Current Amplifier Gain Meas Fail
2635	Wideband Thermal Sensor Cal Diverge
2636	Wideband Sensor Amp Offset Too Big
2637	Wideband Ext Cal Point Bad Const ID
2638	5725 ACV Sense Amp Offset Diverge
2639	5725 ACV Sense Amp Gain Diverge
2640	5725 ACV Flatness Ref Freq Failure
2641	5725 ACV Flatness Cal Freq Failure
2642	External V Reference Value Out Of Range
2643	5725 Diagnostic DAC Cal did not Converge
2645	52120A Source Range Gain Diverge
2646	DAC Appears To Not Meet Linearity Spec
2647	ACV Buffer Offset Too Large
2648	5725 ACV Flat Test Cap Too Large
2649	5725 ACV Flat Test Cap Too Large

2650	Could not Cal 100 M Ω (Meas 2)
2651	Invalid Security Passcode
2652	Passcode Be 1 to 8 Digits

2700-Level Faults: Self Diagnostics (Current)	
2700	A7: 8255 Control Word
2701	A7: 8255 Port A Fault
2702	A7: 8255 Port B Fault
2703	A7: 8255 Port C Fault
2705	A7: Oven Regulation Fault
2706	A7: Current Compliance Fault
2707	A7: Hardware Initialization Fault
2709	A7: Current Magnitude Fault
2710	A7: Dummy Load Current Fault
2711	Assembly A7 Is Not Responding
2712	A7: Hi-Res Clock Fault
2713	A7: Hi-Res Loop Fault In 100HZ Range
2714	A7: Hi-Res Loop Fault In 1KHZ Range
2715	A7: Hi-Res Loop Fault In 10KHZ Range
2716	A7: Hi-Res Loop Fault In 100KHZ Range
2717	A7: Hi-Res Loop Fault In 1MHZ Range
2718	Fault In Setting Up AC For Diagnostics
2719	A7: 8255 Was Reset

2800-Level Faults: Self Diagnostics (DAC)	
2800	A11: 8255 Control Word
2801	A11: 8255 Port A Wires
2802	A11: 8255 Port B Data Bus
2803	A11: 82C54 Status Words
2804	A11: DAC Heaters Not Regulated
2805	Calibrator Not Warmed Up
2806	A11: ADC Amp Output Noise
2807	A11: ADC Amp Output Offset
2808	A11: ADC Amp Gain Error
2809	A11: DAC Monitoring Fault

2810	A11: +11 V DC Range Fault
2811	A11: -11 V DC Range Fault
2812	A11: +22 V DC Range Fault
2813	A11: -22 V DC Range Fault
2814	A11: 6.5 V Buffered Reference Fault
2815	A11: 6.5 V Reference Fault
2816	A11: 13 V Buffered Reference Fault
2817	A11: 13 V Reference Fault
2818	Assembly A11 Missing
2819	A11: 8255 Was Reset
2820	A11: Fine Adjust Channel Fault
2821	A8/A11: +11/22 V DC Zero Estimate Fault
2822	A8/A11: -11/22 V DC Zero Estimate Fault
2823	A11: Could not Estimate +11 V Or 22 V Gain
2824	A11: Could not Estimate 6.5 V Or 13 V Ref
2825	A11: Could not Est 6.5 V Or 13 V Buf Ref
2826	A11: A/D Overload Fault

3100-Level Faults: Self Diagnostics (High Voltage)	
3100	A14: 8255 Control Word
3101	A14: 8255 Port A Fault
3102	A14: 8255 Port B Fault
3103	A14: 8255 Port C Fault
3104	A15: HV Oven Regulation Fault
3105	A15: HV I Oven Regulation Fault
3106	A15: DC HV Amp Noise Fault
3107	A15: DC HV Amp Offset Fault
3108	A15: DC HV Amp Gain Fault
3109	A15: HV +DC Preamplifier Fault
3110	A15: HV +DC Series Pass & Current Fault
3111	A15: HV +DC High Voltage Output Fault
3112	A15: HV +DC Ref/Error Amplitude Fault
3113	A15: HV -DC Preamplifier Fault
3114	A15: HV -DC Series Pass & Current Fault
3115	A15: HV -DC High Voltage output Fault

3116	A15: HV -DC Reference/Error Amp Fault
3117	A14/A15: HV +DC Current Error Amp Fault
3118	A14/A15: HV -DC Current Error Amp Fault
3119	A14/A15: HV +DC Current Abs. Value
3120	A14/A15: HV -DC Current Abs. Value
3122	A14/A15: HV AC 1 KHZ, Preamp Fault (lo)
3123	A14/A15: HV AC 1 KHZ, Preamp Fault (mid)
3124	A14/A15: HV AC 1 KHZ, Preamp Fault (hi)
3125	A14/A15: HV AC 100 HZ, Preamp Fault (lo)
3126	A14/A15: HV AC 100 HZ, Preamp Fault
3127	A14/A15: HV AC 100 HZ, Preamp Fault (hi)
3128	A14/A15: HV AC 1 KHZ, Output Fault (lo)
3129	A14/A15: HV AC 1 KHZ, Output Fault (mid)
3130	A14/A15: HV AC 1 KHZ, Output Fault (hi)
3131	A14/A15: HV AC 100 HZ, Output Fault (lo)
3132	A14/A15: HV AC 100 HZ, Output Fault (mid)
3133	A14/A15: HV AC 100 HZ, Output Fault (hi)
3135	Assembly A14 Not Responding
3136	A14: 8255 Was Reset
3137	A14/A15/A16: 2.2 A AC Range Mag. Fault
3138	A14/A15/A16: 2.2 A AC Range Compliance
3139	A14/A15/A16: 2.2 A AC Range Amplitude
3140	A14/A15/A16: 2.2 A AC Range Abs. Value
3141	A14/A15/A16: 2.2 A DC Range Dummy Load
3142	A14/A15/A16: 2.2 A DC Range Compliance
3143	A14/A15/A16: 2.2 A DC Range Magnitude

3200-Level Faults: Self Diagnostics (Misc)	
3200	Assemblies Missing
3201	Unknown Diagnostic Test
3202	5725 ACV Sense Amp Fault
3203	5725 ACV Standby 5725 Fault
3204	5725 ACV Operate 5725 Fault
3205	5725 ACV Cal Sensor Test Died
3206	5725 ACV Cal Sensor Fault

3207	5725 ACV VLF (100 Hz) will not Converge
3208	5725 ACV LF (1 kHz) will not Converge
3209	5725 ACV MF (10 kHz) will not Converge
3210	5725 ACV HF (100 kHz) will not Converge
3211	5725 Current Path To Shunt Open
3212	5725 Shunt Sense Open
3213	5725 Shunt Measurement Out Of Tolerance
3214	5725 Current Amplifier Offset Too Large
3215	5725 Current Drive Path Open
3216	5725 Current Error Amplifier Failure
3217	5725 Amplifier Not Connected

3300-Level Faults: Self Diagnostics (Ohms)	
3300	A9: 8255 Control Word
3301	A9: 8255 Port A Fault
3302	A9: 8255 Port B Fault
3303	A9: 8255 Port C Fault
3304	A9: 10 V Source Fault
3305	A9: 5 V Source Fault
3306	A9: 2 V Source Fault
3308	A9: Diff Amp Offset Fault
3309	A9: Diff Amp Gain Fault
3310	A9: Diff Amp Noise Fault
3311	A9/A10: Ohms 10:1 Divider Fault
3312	A9/A10: Ohms 1:1 Divider Fault
3313	A9/A10: 10 K Ω Diagnostic Fault
3314	A9/A10: 19 K Ω Cal Diag Fault
3315	A9/A10: 10 Ω Cal Diag Fault
3316	A9/A10: 19 Ω Cal Diag Fault
3317	A9/A10: 100 K Ω Ratio Fault
3318	A9/A10: 190 K Ω Ratio Fault
3319	A9/A10: 1 M Ω Ratio Fault
3320	A9/A10: 1.9 M Ω Ratio Fault
3321	A9/A10: 10 M Ω Ratio Fault
3322	A9/A10: 19 M Ω Ratio Fault 1

3323	A9/A10: 19 M Ω Ratio Fault 2
3324	A9/A10: 100 M Ω Ratio Fault
3325	A9/A10: 10 K Ω Check Fault
3326	A9/A10: 19 K Ω Check Fault
3327	A9/A10: 1 K Ω Check Fault
3328	A9/A10: 1.9 K Ω Check Fault
3329	A9/A10: 100 Ω Check Fault
3330	A9/A10: 190 Ω Check Fault
3331	A9/A10: 10 Ω Check Fault
3332	A9/A10: 19 Ω Check Fault
3333	A9/A10: 1 Ω Check Fault
3334	A9/A10: 1.9 Ω Check Fault
3335	A9/A10: Ohms Short Check Fault
3336	A9/A10: 2 Wire Compensation Fault
3337	A9/A10: Ohms Correction Factor Fault
3338	Assembly A9 Not Responding
3339	A9: 8255 Was Reset
3340	A9/A10: 100 Ω Cal Diag Fault
3341	A9/A10: 190 Ω Cal Diag Fault

3400-Level Faults: Self Diagnostics (Oscillator)	
3400	A12: 8255 Control Word
3401	A12: 8255 Port A
3402	A12: 8255 Port B
3403	A12: 8255 Port C
3404	A13: 8255 Control Word
3405	A13: 8255 Port A
3406	A13: 8255 Port B
3407	A13: 8255 Port C
3408	A13: Fixed Ampl. Osc Fault
3409	A13: Phase Lock Loop Fault
3410	A12/A13: 22 V Amp Bias Adj Error
3411	A12/A13: 22 V Amp Nonfunctional
3412	A12 To A13 Interface Fault
3413	A12/A13: 14-bit DAC Nonfunctional

3414	A12/A13: Nonlinear Control Loop 2Vrng
3415	A12/A13: nonlinear Control Loop 20Vrng
3416	A12/A13: DAC 15th Bit Fault
3417	A12: DC Sensor Buffer Fault
3418	A12: Sensor Loop/Sq. Root Amp Fault
3419	A12: AC Sensor Buff (2V Range)
3420	A12: AC Sensor Buff (20V Range)
3421	A12: AC Cal Sensor (2V Range)
3422	A12: AC Cal Sensor (20V Range)
3423	Assembly A12 Missing
3424	Assembly A13 Missing
3425	Assembly A12 Or A13 Not Responding
3426	A12: 8255 Was Reset
3427	A13: 8255 Was Reset

3500-Level Faults: Self Diagnostics (Power Amp)	
3500	A16: 8255 Control Word
3501	A16: 8255 Port A
3502	A16: 8255 Port B
3503	A16: 8255 Port C
3507	A16: PA Supplies Are Off
3508	A16/A14: 220 V AC Range Output Fault
3509	A16: Amplifier Loop Not Regulated
3510	A16: 220 V Amp Fault
3511	A16: Incorrect PA Input
3520	A16: PA Oven Regulation Fault
3521	Assembly A16 Is Not Responding
3524	A16: Power Amp Is Too Hot
3525	220 V DC Initialization Fault
3526	220 V AC Initialization Fault
3527	A16: Power Amp DC Cal Network Zero Fault
3528	A16: Power Amp DC Cal Network Gain Fault
3529	A16: Pwr Amp 220V Range Attenuator Fault
3530	A16: 8255 Was Reset

3600-Level Faults: Self Diagnostics (Power Supplies)	
3600	+17S Supply Fault
3601	-17S Supply Fault
3602	+15S Supply Fault
3603	-15S Supply Fault
3604	+42S Supply Fault
3605	-42S Supply Fault
3606	LH COM Ground Fault
3607	-5LH Supply Fault
3608	5RLH Supply Fault
3609	8RLH Supply Fault
3610	+PA Supply Fault
3611	-PA Supply Fault
3612	+15 OSC Supply Fault
3613	-15 OSC Supply Fault
3614	OSC COM Ground Fault
3615	S COM Ground Fault

3700-Level Faults: Self Diagnostics (Rear I/O)	
3700	A21: 8255 Control Word
3701	A21: 8255 Port A Fault
3702	A21: 8255 Port B Fault
3703	A21: 8255 Port C Fault
3704	Assembly A21 Not Responding
3705	A21: Rear Panel Data Bus Fault
3708	A21: 8255 Was Reset

3800-Level Faults: Self Diagnostics (Switch Matrix)	
3800	A8: 8255 Control Word
3801	A8: 8255 Port A Fault
3802	A8: 8255 Port B Fault
3803	A8: 8255 Port C Fault
3804	A8: Zero Amp Lo Noise Fault
3805	A8: Zero Amp Lo Offset
3806	A8: Zero Amp Lo Gain Fault

3807	A8: Zero Amp Hi Noise Fault
3808	A8: Zero Amp Hi Offset
3809	A8: Zero Amp Hi Gain Fault
3810	A8: 2.2 V Amp Noise Fault
3811	A8: Zero Amp Offset
3812	A8: 2.2 V Gain Fault
3813	A8: 220 mV Offset Fault
3814	A8: 220 mV Divider Fault
3815	A8: 22 mV Divider Fault
3818	A8: Out Lo To Sense Lo Continuity Fault
3819	A8: Relay Fault
3824	A8: Oven Regulation Fault
3825	Assembly A8 Not Responding
3826	A8: 8255 Was Reset
3827	Assembly A8 Too Hot

3900-Level Faults: Self Diagnostics (Wideband)	
3900	A5: 8255 Control Word
3901	A5: 8255 Port A Fault
3902	A5: 8255 Port B Fault
3903	A5: 8255 Port C Fault
3904	Optional Assemblies A5/A6 Are Missing
3905	A6: Phase Lock Loop Fault
3906	A6: Phase Lock Loop Fault At 30Mhz
3907	A5: RMS Sensor Fault
3908	A5: RMS Sensor Fault At 30Mhz
3909	A5: RMS Sensor Fault At 6.5V DC in
3910	A5/A6: Ampl. Control Fault
3911	A5/A6: Ampl. Control Fault At 30Mhz
3912	A5/A6: Output Offset Fault
3913	A5/A6: Output Offset Fault At 30Mhz
3914	A5: 0 DB Output Attenuation Fault
3915	A5: 10 DB Output Attenuation Fault
3916	A5: 20 DB Output Attenuation Fault
3917	A5: 30 DB Output Attenuation Fault

3918	A5: 40 DB Output Attenuation Fault
3922	A5/A6: Wideband Initialization Fault
3923	A5: 8255 Was Reset

4000-Level Faults: Analog Sequencing	
4000	Bad Sequence ID
4001	Over Nested Subsequences
4002	Bad Sequence Command Code
4003	Bad Reply Size From Inguard
4004	Reply From Inguard Too Small
4005	False MSG Semaphore from Inguard
4006	Inguard CPU POP
4007	Inguard CPU Reset
4008	Inguard CPU A/D Timeout
4009	Inguard CPU Timed Out On Main CPU
4010	Inguard CPU Detected A Command Error
4012	Sequencer Timed Out Waiting For Inguard
4013	Illegal Analog State Command For 5725
4014	Sequencer Timed Out Waiting for 5725
4015	Could not Queue Command To 5725 BX
4016	Reply From 5725 Was Garbled

4100-Level Faults: Serial Interface Driver	
4100	Bad Virtual channel
4101	Framing
4102	Input Queue Overflow
4103	Overrun
4104	Parity
4105	Uart Failed Self Test
4107	Remote Interface UART
4108	Remote Interface USB
4109	Guard Crossing UART
4110	Boost Crossing UART

4200-Level Faults: Instrument State Manager	
4200	Bad Boolean Value Selector
4201	Meaningless Target State Value
4202	Meaningless Actual State Value
4203	Mystery Target/Actual State Difference
4204	Display Brightness Setting Exceeds Limits

4400-Level Faults: General Purpose Utility	
4400	Invalid Command
4401	Floating Point Math Error

4500-Level Faults: Analog Value Finder	
4500	VFdcDac Value Out Of DAC Range
4501	Bad Range Selector
4502	Non-Vfinder Range
4504	User Range Adjust of 0 (I used 1)
4505	Divide By 0 In (VF)correct

4700-Level Faults: Ethernet	
4700	Port value out of range
4701	Could not open the ENET port
4702	Error reading from ENET port
4703	Ethernet address not valid
4704	Ethernet hostname not valid
4705	Ethernet hostname too long
4706	Cannot get DHCP IP address
4707	ENET Port 1
4708	ENET Remote Interface
4709	Port value already in use
4710	Cannot Change Ethernet Settings Now

4800-Level Faults: GPIB	
4800	Error opening GPIB Controller
4801	Error setting GPIB Primary Address
4802	Error occurred reading characters from GPIB controller
4803	Error occurred sending characters to the GPIB controller
4804	GPIB DOS Error
4805	GPIB Specified Interface Board is not Active Controller
4806	GPIB No present listening devices
4807	GPIB Interface Board has not been addressed properly
4808	GPIB Invalid argument
4809	GPIB Specified Interface Board is not System Controller
4810	GPIB I/O operation aborted (time-out)
4811	GPIB Non-existent GPIB board
4812	GPIB Routine not allowed during asynchronous I/O operation
4813	GPIB No capability for operation
4814	GPIB File System Error
4815	GPIB Command byte transfer error
4816	GPIB Serial poll status byte lost
4817	GPIB SRQ stuck in ON position
4818	GPIB Table problem

4900-Level Faults: USB Host	
4900	Failed to mount USB drive
4901	Failed to copy files

5000-Level Faults: 52120A Boost System	
5000	Error while reading 52120A cal store
5001	Expected a 52120A but it was gone
5002	52120A cal store corrupted
5003	Value out of range of 52120A
5004	Unknown error reported by 52120A
5005	52120A added or removed
5006	52120A forceably turned off
5007	52120A detected over compliance
5008	52120A detected over range
5009	52120A detected over temperature
65535	Unknown

Appendix B
ASCII and IEEE-488 Bus Codes

ASCII CHAR.	DECIMAL	OCTAL	HEX	BINARY 7654 3210	DEV. NO.	MESSAGE ATN=TRUE	ASCII CHAR.	DECIMAL	OCTAL	HEX	BINARY 7654 3210	DEV. NO.	MESSAGE ATN=TRUE
NUL	0	000	00	0000 0000			@	64	100	40	0100 0000	0	MTA
SQH	1	001	01	0000 0001		GTL	A	65	101	41	0100 0001	1	MTA
STX	2	002	02	0000 0010			B	66	102	42	0100 0010	2	MTA
ETX	3	003	03	0000 0011			C	67	103	43	0100 0011	3	MTA
EOT	4	004	04	0000 0100		SDC	D	68	104	44	0100 0100	4	MTA
ENQ	5	005	05	0000 0101		PPC	E	69	105	45	0100 0101	5	MTA
ACH	6	006	06	0000 0110			F	70	106	46	0100 0110	6	MTA
BELL	7	007	07	0000 0111			G	71	107	47	0100 0111	7	MTA
BS	8	010	08	0000 1000		GET	H	72	110	48	0100 1000	8	MTA
HT	9	011	09	0000 1001		TC	I	73	111	49	0100 1001	9	MTA
LF	10	012	0A	0000 1010			J	74	112	4A	0100 1010	10	MTA
VT	11	013	0B	0000 1011			K	75	113	4B	0100 1011	11	MTA
FF	12	014	0C	0000 1100			L	76	114	4C	0100 1100	12	MTA
CR	13	015	0D	0000 1101			M	77	115	4D	0100 1101	13	MTA
SO	14	016	0E	0000 1110			N	78	116	4E	0100 1110	14	MTA
SI	15	017	0F	0000 1111			O	79	117	4F	0100 1111	15	MTA
DLE	16	020	10	0001 0000		LLO	P	80	120	50	0101 0000	16	MTA
DC1	17	021	11	0001 0001			Q	81	121	51	0101 0001	17	MTA
DC2	18	022	12	0001 0010			R	82	122	52	0101 0010	18	MTA
DC3	19	023	13	0001 0011			S	83	123	53	0101 0011	19	MTA
DC4	20	024	14	0001 0100		DCL	T	84	124	54	0101 0100	20	MTA
NAK	21	025	15	0001 0101		PPU	U	85	125	55	0101 0101	21	MTA
SYN	22	026	16	0001 0110			V	86	126	56	0101 0110	22	MTA
ETB	23	027	17	0001 0111			W	87	127	57	0101 0111	23	MTA
CAN	24	030	18	0001 1000		SPE	X	88	130	58	0101 1000	24	MTA
EM	25	031	19	0001 1001		SPD	Y	89	131	59	0101 1001	25	MTA
SUB	26	032	1A	0001 1010			Z	90	132	5A	0101 1010	26	MTA
ESC	27	033	1B	0001 1011			[91	133	5B	0101 1011	27	MTA
FS	28	034	1C	0001 1100			\	92	134	5C	0101 1100	28	MTA
GS	29	035	1D	0001 1101]	93	135	5D	0101 1101	29	MTA
RS	30	036	1E	0001 1110			^	94	136	5E	0101 1110	30	MTA
US	31	037	1F	0001 1111			_	95	137	5F	0101 1111	30	UNT
SPACE	32	040	20	0010 0000	0	MLA	,	96	140	60	0111 0000	0	MSA
!	33	041	21	0010 0001	1	MLA	a	97	141	61	0111 0001	1	MSA
"	34	042	22	0010 0010	2	MLA	b	98	142	62	0111 0010	2	MSA
#	35	043	23	0010 0011	3	MLA	c	99	143	63	0111 0011	3	MSA
\$	36	044	24	0010 0100	4	MLA	d	100	144	64	0111 0100	4	MSA
%	37	045	25	0010 0101	5	MLA	e	101	145	65	0111 0101	5	MSA
&	38	046	26	0010 0110	6	MLA	f	102	146	66	0111 0110	6	MSA
'	39	047	27	0010 0111	7	MLA	g	103	147	67	0111 0111	7	MSA
(40	050	28	0010 1000	8	MLA	h	104	150	68	0111 1000	8	MSA
)	41	051	29	0010 1001	9	MLA	i	105	151	69	0111 1001	9	MSA
*	42	052	2A	0010 1010	10	MLA	j	106	152	6A	0111 1010	10	MSA
+	43	053	2B	0010 1011	11	MLA	k	107	153	6B	0111 1011	11	MSA
,	44	054	2C	0010 1100	12	MLA	l	108	154	6C	0111 1100	12	MSA
-	45	055	2D	0010 1101	13	MLA	m	109	155	6D	0111 1101	13	MSA
.	46	056	2E	0010 1110	14	MLA	n	110	156	6E	0111 1110	14	MSA
/	47	057	2F	0010 1111	15	MLA	o	111	157	6F	0111 1111	15	MSA
0	48	060	30	0011 0000	16	MLA	p	112	160	70	0111 0000	16	MSA
1	49	061	31	0011 0001	17	MLA	q	113	161	71	0111 0001	17	MSA
2	50	062	32	0011 0010	18	MLA	r	114	162	72	0111 0010	18	MSA
3	51	063	33	0011 0011	19	MLA	s	115	163	73	0111 0011	19	MSA
4	52	064	34	0011 0100	20	MLA	t	116	164	74	0111 0100	20	MSA
5	53	065	35	0011 0101	21	MLA	u	117	165	75	0111 0101	21	MSA
6	54	066	36	0011 0110	22	MLA	v	118	166	76	0111 0110	22	MSA
7	55	067	37	0011 0111	23	MLA	w	119	167	77	0111 0111	23	MSA
8	56	070	38	0011 1000	24	MLA	x	120	170	78	0111 1000	24	MSA
9	57	071	39	0011 1001	25	MLA	y	121	171	79	0111 1001	25	MSA
:	58	072	3A	0011 1010	26	MLA	z	122	172	7A	0111 1010	26	MSA
;	59	073	3B	0011 1011	27	MLA	{	123	173	7B	0111 1011	27	MSA
<	60	074	3C	0011 1100	28	MLA		124	174	7C	0111 1100	28	MSA
=	61	075	3D	0011 1101	29	MLA	}	125	175	7D	0111 1101	29	MSA
>	62	076	3E	0011 1110	30	MLA	~	126	176	7E	0111 1110	30	MSA
?	63	077	3F	0011 1111		UNL		127	177	7F	0111 1111		UNS

TALK ADDRESSES

SECONDARY ADDRESSES

Appendix C

Glossary

adc (analog-to-digital converter)

A device or circuit that converts an analog voltage to digital signals.

absolute accuracy

Accuracy specifications that include the error contributions made by all equipment and standards used to calibrate the instrument. Absolute accuracy is the number to compare with the UUT for determining test specification ratio.

assert

To cause a digital signal line to go into a logic true state.

af (audio frequency)

The frequency range of human hearing; normally 15 Hz - 20,000 Hz.

artifact standard

An object that produces or embodies a physical quantity to be standardized, for example a Fluke 732B dc Voltage Reference Standard.

base units

Units in the SI system that are dimensionally independent. All other units are derived from base units. The only base unit in electricity is the ampere.

buffer

Refers to either an area of digital memory for temporary storage of data, or an amplifier stage before the final amplifier.

burden voltage

The maximum sustainable voltage across the terminals of a load.

calibration check

A fast, simple, automated procedure to provide added confidence between calibration recalls, and data that can be used to develop a history of Calibrator performance between calibrations. No changes are made to stored constants, and the internal check standards are used as the reference points instead of external standards as in the routine calibration procedure.

calibrate

To compare a measurement system or device of unknown accuracy to a measurement system or device of known and greater accuracy to detect or correct any variation from required performance of the unverified measurement system or device.

calibration constant

A correction factor that is applied manually or automatically to correct the output or reading of an instrument.

calibration curve

A smooth curve drawn through a graph of calibration points.

calibration interval

The interval after which calibration must occur to maintain the performance of an instrument as stated in its specifications.

check standard

A device used solely to verify the integrity of another standard. For example in the Calibrator, one Fluke RMS sensor continuously monitors the output voltage while a second Fluke RMS sensor confirms the integrity of the first.

characterization

The development of a table of calibration constants or correction factors for use in correcting the output or reading of an instrument.

common mode noise

An undesired signal that exists between a device's terminals and ground. Common mode noise is at the same potential on both terminals of a device.

compliance voltage

The maximum voltage a constant-current source can supply.

control chart

A chart devised to monitor one or more processes in order to detect the excessive deviation from a desired value of a component or process.

crest factor

The ratio of the peak voltage to the rms voltage of a waveform (with the dc component removed).

current guard

A generator that drives the inner shield of a triaxial cable with a signal of the same amplitude and phase as a Calibrator's ac current output signal on the center conductor. The current guard shields the Calibrator's output signal from a capacitive leakage path to ground.

DAC (digital-to-analog converter)

A device or circuit that converts a digital waveform to an analog voltage.

dBm

Power level expressed as decibels above or below 1 mW.

derived units

Units in the SI system that are derived from base units. Volts, ohms, and watts are derived from amperes and other base and derived units.

distortion

Undesired changes in the waveform of a signal. Harmonic distortion disturbs the original relationship between a frequency and other frequencies naturally related to it. Intermodulation distortion (imp) introduces new frequencies by the mixing of two or more original frequencies. Other forms of distortion are phase distortion and transient distortion.

errors

The different types of errors described in this glossary are: offset error, linearity error, random error, scale error, systematic errors, and transfer error. Each of these are defined in this glossary.

flatness

A measure of the variation of the actual output an ac voltage source at different frequency points when set to the same nominal output level. A flat voltage source exhibits very little error throughout its frequency range.

floor

The part of the uncertainty specification of an instrument that is typically a fixed offset plus noise. Floor can be expressed as units such as microvolts or counts of the least significant digit. For the Calibrator, the floor specification is combined with fixed range errors in one term.

full scale

The maximum reading of a range of a meter, analog-to-digital converter, or other measurement device, or the maximum attainable output on a range of a calibrator.

gain error

Same as scale error. Scale or gain error results when the slope of the meter's response curve is not exactly 1. A meter with only gain error (no offset or linearity error), will read 0V with 0V applied, but something other than 10V with 10V applied.

ground

The voltage reference point in a circuit. Earth ground is a connection through a ground rod or other conductor to the earth, usually accessible through the ground conductor in an ac power receptacle.

ground loops

Undesirable currents induced when there is more than one chassis ground potential in a system of instruments. Ground loops can be minimized by connecting all instruments in a system to ground to one point.

guard

See “voltage guard” and “current guard.”

International System of Units

Same as “SI System of Units”; the accepted system of units. See also “units”, “base units”, and “derived units.”

legal units

The highest echelon in a system of units, for example the U.S. National Bureau of Standards volt.

life-cycle cost

The consideration of all elements contributing to the cost of an instrument throughout its useful life. This includes initial purchase cost, service and maintenance cost, and the cost of support equipment.

linearity

The relationship between two quantities when a change in the first quantity is directly proportional to a change in the second quantity.

linearity error

Linearity error occurs when the response curve of a meter is not exactly a straight line. This type of error is measured by fixing two points on the response curve, drawing a line through the points, then measuring how far the curve deviates from the straight line at various points on the response curve.

MAP (Measurement Assurance Program)

A program for a measurement process. A MAP provides information to demonstrate that the total uncertainty of the measurements (data), including both random error and systematic components of error relative to national or other designated standards is quantified, and sufficiently small to meet requirements.

MTBF (Mean Time Between Failures)

The time interval in operating hours that can be expected between failure of equipment. MTBF can be calculated from direct observation or mathematically derived through extrapolation.

MTTF (Mean Time to Fail)

The time interval in operating hours that can be expected until the first failure of equipment. MTF can be calculated from direct observation or mathematically derived through extrapolation.

MTTR (Mean Time to Repair)

The average time in hours required to repair failed equipment.

minimum use specifications

A compilation of specifications that satisfies the calibration requirements of a measurement system or device. The minimum use specifications are usually determined by maintaining a specified test uncertainty ratio between the calibration equipment and the unit under test.

noise

A signal containing no useful information that is superimposed on a desired or expected signal.

normal mode noise

An undesired signal that appears between the terminals of a device.

offset error

Same as zero error. The reading shown on a meter when an input value of zero is applied is its offset or zero error.

precision

The degree of agreement among independent measurements of a quantity under the same conditions. (Same as “repeatability.”)

The precision of a measurement process is the coherence, or the closeness to the one result, of all measurement results. High precision, for example would result in a tight pattern of arrow hits on a target, without respect to where on the target the tight pattern falls.

predictability

A measure of how accurately the output value of a device can be assumed after a known time following calibration. If a device is highly stable, it is also predictable. If a device is not highly stable, but its value changes at the same rate every time after calibration, its output has a higher degree of predictability than a device that exhibits random change.

primary standard

A standard defined and maintained by some authority and used to calibrate all other secondary standards.

process metrology

Tracking the accuracy drift of calibration and other equipment by applying statistical analysis to correction factors obtained during calibration.

random error

Any error which varies in an unpredictable manner in absolute value and in sign when measurements of the same value of a quantity are made under effectively identical conditions.

range

The stated upper end of a measurement device's span. Usually, however, a measurement device can measure quantities for a specified percentage overrange. (The absolute span including overrange capability is called "scale.") In the Calibrator, however, range and scale are identical.

range calibration

An optional calibration procedure available to enhance the Calibrator specifications by nulling the output to an external standard.

reference amplifier

DC voltage references developed for the Calibrator. These are 6.5V hybrid devices consisting of a zener diode and a transistor on a heated substrate. These reference amplifiers exhibit extremely low uncertainty and drift, and are superior to zener diode or temperature-compensated zener diode voltage references.

reference standard

The highest-echelon standard in a laboratory; the standard that is used to maintain working standards that are used in routine calibration and comparison procedures.

relative accuracy

Calibrator accuracy specifications that exclude the effects of external dividers and standards, for use when range constants are adjusted. Relative uncertainty includes only the stability, temperature coefficient, noise, and linearity specifications of the Calibrator itself.

reliability

A measure of the "uptime" of an instrument.

repeatability

The degree of agreement among independent measurements of a quantity under the same conditions. (Same as "precision.")

resistance

A property of a conductor that determines the amount of current that will flow when a given amount of voltage exists across the conductor. Resistance is measured in ohms. One ohm is the resistance through which one volt of potential will cause one ampere of current to flow.

resolution

The smallest change in quantity that can be detected by a measurement system or device. For a given parameter, resolution is the smallest increment that can be measured, generated or displayed.

rf (radio frequency)

The frequency range of radio waves; ranging from 150 kHz up to the infrared range.

rms (root-mean-square)

The value assigned to an ac voltage or current that results in the same power dissipation in a resistance as a dc current or voltage of the same value.

rms sensor

A device that converts ac voltage to dc voltage with great accuracy. RMS sensors operate by measuring the heat generated by a voltage through a known resistance (for example, power); therefore, they sense true rms voltage.

scale

The absolute span of the reading range of a measurement device including overrange capability.

scale error

Same as gain error. Scale or gain error results when the slope of the meter's response curve is not exactly 1. A meter with only scale error (no offset or linearity error), will read 0 V with 0 V applied, but something other than 10 V with 10 V applied.

secondary standard

A standard maintained by comparison against a primary standard.

sensitivity

The degree of response of a measuring device to the change in input quantity, or a figure of merit that expresses the ability of a measurement system or device to respond to an input quantity.

shield

A grounded covering device designed to protect a circuit or cable from electromagnetic interference.

SI System of Units

The accepted International System of Units. See also "units", "base units", and "derived units."

stability

A measure of the freedom from drift in value over time and over changes in other variables such as temperature. Note that stability is not the same as uncertainty.

standard

A device that is used as an exact value for reference and comparison.

standard cell

A primary cell that serves as a standard of voltage. The term “standard cell” often refers to a “Weston normal cell”, which is a wet cell with a mercury anode, a cadmium mercury amalgam cathode, and a cadmium sulfate solution as the electrolyte.

systematic errors

Errors in repeated measurement results that remain constant or vary in a predictable way.

temperature coefficient

A factor per °C deviation from a nominal value or range that the uncertainty of an instrument increases. This specification is necessary to account for the thermal coefficients in a calibrator’s analog circuitry.

test uncertainty ratio

The numerical ratio of the uncertainty of the measurement system or device being calibrated to the uncertainty of the measurement system or device used as the Calibrator. (Also called “test accuracy ratio.”)

thermal emf

The voltage generated when two dissimilar metals joined together are heated.

traceability

The ability to relate individual measurement results to national standards or nationally accepted measurement systems through an unbroken chain of comparisons, for example, a calibration “audit trail.”

Measurements, measurement systems or devices have traceability to the designated standards if and only if scientifically rigorous evidence is produced on a continuing basis to show that the measurement process is producing measurement results for which the total measurement uncertainty relative to national or other designated standards is qualified.

transfer error

The sum of all new errors induced during the process of comparing one quantity against another.

transfer standard

Any working standard used to compare a measurement process, system or device at one location or level with another measurement process, system, or device at another location or level.

transport standard

A transfer standard that is rugged enough to allow shipment by common carrier to another location.

true value

Also called legal value, the accepted, consensus, (for example, the correct value of the quantity being measured).

uncertainty

The maximum difference between the accepted, consensus, or true value and the measured value of a quantity. Uncertainty is normally expressed in units of ppm (parts per million) or as a percentage. (Accuracy is the same as 1 - % uncertainty.)

units

Symbols or names that define the measured quantities. Examples of units are: V, mV, A, kW, and dBm. See also "SI System of Units."

volt

The unit of emf (electromotive force) or electrical potential in the SI system of units. One volt is the difference of electrical potential between two points on a conductor carrying one ampere of current, when the power being dissipated between these two points is equal to one watt.

watt

The unit of power in the SI system of units. One watt is the power required to do work at the rate of one joule/second. In terms of volts and ohms, one watt is the power dissipated by one ampere flowing through a 1Ω load.

wideband

AC voltage at frequencies up to and including the radio frequency spectrum.

verification

Checking the functional performance and uncertainty of an instrument or standard without making adjustments to it or changing its calibration constants.

voltage guard

A floating shield around voltage measurement circuitry inside an instrument. The voltage guard provides a low-impedance path to ground for common-mode noise and ground currents, thereby eliminating errors introduced by such interference.

working standard

A standard that is used in routine calibration and comparison procedures in the laboratory, and is maintained by comparison to reference standards.

zero error

Same as offset error. The reading shown on a meter when an input value of zero is applied is its zero or offset error.

