

- DIGITAL GROUND RESISTANCE AND SOIL RESISTIVITY TESTER

# 6470-B





# **Statement of Compliance**

---

Chauvin Arnoux®, Inc. d.b.a. AEMC® Instruments certifies that this instrument has been calibrated using standards and instruments traceable to international standards.

We guarantee that at the time of shipping your instrument has met its published specifications.

**An NIST traceable certificate may be requested at the time of purchase, or obtained by returning the instrument to our repair and calibration facility, for a nominal charge.**

The recommended calibration interval for this instrument is 12 months and begins on the date of receipt by the customer. For recalibration, please use our calibration services. Refer to our repair and calibration section at **[www.aemc.com](http://www.aemc.com)**.

**Serial #:** \_\_\_\_\_

**Catalog #:** \_\_\_\_\_

**Model #:** 6470-B

Please fill in the appropriate date as indicated:

Date Received: \_\_\_\_\_

Date Calibration Due: \_\_\_\_\_



Chauvin Arnoux®, Inc.  
d.b.a AEMC® Instruments  
**[www.aemc.com](http://www.aemc.com)**



## READ CAREFULLY BEFORE USING FOR THE FIRST TIME

---

Your instrument is equipped with a NiMH battery. This technology offers several advantages:

- **Long battery charge life for a limited volume and weight.**
- **Possibility of quickly recharging your battery.**
- **Significantly reduced memory effect: you can recharge your battery even if it is not fully discharged.**
- **Respect for the environment: no pollutant materials such as lead or cadmium, in compliance with the applicable regulations.**

*After prolonged storage, the battery may be completely discharged. If so, it must be completely recharged.*

**Your instrument may not function during part of this recharging operation.**

Full recharging of a completely discharged battery may take several hours.



**NOTE:** In this case, at least 5 charge/discharge cycles will be necessary for your battery to recover 95% of its capacity.

---

To make the best possible use of your battery and extend its effective service life:

- **Only use the charger supplied with your instrument. Use of another charger may be dangerous.**
- **Only charge your instrument at temperatures between 0° and 40°C.**
- **Comply with the conditions of use defined in the operating manual.**
- **Comply with the storage conditions specified in the operating manual.**

NiMH technology allows a limited number of charge/discharge cycles depending significantly on:

- **The conditions of use.**
- **The charging conditions.**



Please refer to § 9 for correct replacement of the battery.



Do not dispose of the battery pack with other solid waste. Used batteries must be entrusted to a qualified recycling company or to a company specialized in processing hazardous materials.

# Table of Contents

---

---

<b>1. INTRODUCTION</b>	<b>6</b>
1.1 International Electrical Symbols	7
1.2 Definition of Measurement Categories	7
1.3 Receiving Your Shipment	7
1.4 Ordering Information	7
1.4.1 Kits, Accessories and Replacement Parts	8
<b>2. PRODUCT FEATURES</b>	<b>9</b>
2.1 Description	9
2.2 Key Features	10
2.3 Control Features	11
2.4 Display	12
2.5 Button Functions	14
<b>3. SPECIFICATIONS</b>	<b>15</b>
3.1 Reference Conditions	15
3.2 Electrical	15
3.2.1 Frequency Measurements	15
3.2.2 Voltage Measurements	15
3.2.3 DC Resistance Measurements	16
3.2.4 AC Earth/Ground Resistance Measurements	17
3.2.5 Soil Resistivity Measurement $\rho$	18
3.3 Data Storage	20
3.4 Power	20
3.5 Mechanical	21
3.6 Environmental	21
3.7 Safety	21
<b>4. OPERATION</b>	<b>22</b>
4.1 General Operating Instructions	22
4.1.1 Automatic Mode	22
4.1.2 Manual (Expert) Mode	22
4.2 Instrument Configuration (SET-UP mode)	23

<b>5. AUTOMATIC MODE.....</b>	<b>24</b>
5.1 Switching the Test Voltage .....	24
5.2 Resistance Measurement m $\Omega$ (2-Wire).....	24
5.2.1 Lead Compensation Measurement .....	25
5.2.2 Alarm Function.....	26
5.3 Resistance Measurement m $\Omega$ (4-Wire).....	27
5.4 Earth/Ground Measurement (3-Pole).....	28
5.4.1 62% Method.....	28
5.4.2 Full Method .....	30
5.4.3 Recommendations for a Reliable Measurement.....	31
5.5 Earth/Ground Measurement (4-Pole).....	32
5.6 Soil Resistivity Measurements ( $\rho$ Position).....	34
5.6.1 Advantages/Disadvantages of Wenner and Schlumberger ..	34
5.6.2 Changing the Measurement Method.....	35
5.6.3 Programming the Distance for Electrode Placement .....	35
5.6.4 Wenner Method .....	36
5.6.5 Schlumberger Method.....	37
<b>6. MANUAL MODE .....</b>	<b>39</b>
6.1 Switching the Test Voltage .....	39
6.2 Measurement Frequency Selection .....	40
6.3 Manual Settings for m $\Omega$ Measurements .....	40
6.3.1 Continuity Test .....	41
6.4 3-Pole Earth/Ground Measurements & Coupling.....	41
6.4.1 3-Pole Earth/Ground Measurements .....	41
6.4.2 Earth/Ground Coupling Measurements .....	41
6.5 4-Pole Earth/Ground Measurements .....	43
6.6 Soil Resistivity Measurements .....	43
6.7 Smoothing .....	43
<b>7. MEMORY FUNCTION .....</b>	<b>44</b>
7.1 Saving Measurements into Memory.....	44
7.2 Recalling Measurements from Memory .....	45
7.3 Erasing Measurements from Memory .....	45
7.3.1 Erasing All Measurements .....	45
7.3.2 Erasing Selective Measurements .....	45
<b>8. DATAVIEW® SOFTWARE .....</b>	<b>46</b>
8.1 Installing DataView® .....	46
8.2 Connecting the Model 6470-B to your Computer.....	50

8.3	Establishing Communication to the Instrument.....	50
8.4	The Ground Tester Control Panel .....	51
8.5	Configuring the Instrument.....	52
8.5.1	DC Continuity Test .....	53
8.5.2	3-Pole Ground Resistance Test .....	54
8.5.3	4-Pole Ground Resistance .....	55
8.5.4	4-Pole Soil Resistivity .....	56
8.6	Tools Menu.....	57
8.6.1	Tools > Options.....	57
8.6.2	Tools > Colors .....	57
8.6.3	Tools > Recover Data .....	57
8.7	Starting a Test .....	57
8.8	Downloading Data to Database .....	57
8.8.1	Session Properties.....	58
8.9	Exporting the Report to a PDF File .....	59
<b>9.</b>	<b>MAINTENANCE .....</b>	<b>60</b>
9.1	Maintenance.....	60
9.2	Cleaning.....	60
9.3	Fuse Replacement.....	60
9.4	Recharging the Battery .....	61
9.5	Replacing the Battery.....	62
<b>10.</b>	<b>TROUBLESHOOTING .....</b>	<b>64</b>
10.1	Error Reporting.....	64
10.1.1	Electrode Resistance Too High.....	64
10.1.2	Out of Range.....	64
10.1.3	Misconnection .....	64
10.1.4	Out of Limits Indicators .....	65
10.1.5	Error Messages.....	66
<b>APPENDIX A:</b>	<b>GLOSSARY OF TERMS.....</b>	<b>67</b>
	Basic Terminologies .....	67
	Glossary .....	68
	Repair and Calibration.....	71
	Technical and Sales Assistance .....	71
	Limited Warranty .....	72
	Warranty Repairs.....	72





# INTRODUCTION

### **WARNING**

These safety warnings are provided to ensure the safety of personnel. Please **read** and **comply** with these precautions:

- This instrument is protected from accidental voltages of not more than 50V with respect to earth in measurement CAT IV. The guaranteed level of protection of this equipment may be compromised if used in a manner not specified by the manufacturer.
- Safety is the responsibility of the operator.
- All metal objects or wires connected to the electrical system should be assumed to be lethal until tested. Grounding systems are no exception.
- Never exceed the maximum rated voltage and current, and the measurement category.
- Never exceed the protection limits, and always comply with the conditions and place of use, indicated in the specifications.
- Do not use the instrument or its accessories if they appear damaged.
- Use accessories that have overvoltage category and service voltages greater than or equal to those of the instrument (CAT IV 50V). Use only accessories that comply with safety standards (IEC 61010-2-031 & 32).
- Wear the appropriate protective gear (insulating boots and gloves).
- Check that no terminal is connected and the switch is set to OFF before opening the device.
- Use only the charging unit supplied with the instrument to recharge the battery.
- Troubleshooting and metrological verification procedures must only be performed by qualified, approved personnel, or the factory.
- **NOTE:** The potentials on the various rods used for an earth measurement may be different if a nearby electrical installation is defective or certain weather conditions prevail (thunderstorms). It is up to the operator to decide whether to continue or postpone measurements in these situations.

## 1.1 International Electrical Symbols

	Signifies that the instrument is protected by double or reinforced insulation.
	This symbol on the instrument indicates a WARNING that the operator must refer to the user manual for instructions before operating the instrument. In this manual, the symbol preceding instructions indicates that if the instructions are not followed, bodily injury, installation/sample and/or product damage may result.
	Risk of electric shock. The voltage at the parts marked with this symbol may be dangerous.
	Ground/Earth symbol
	In conformity with WEEE 2002/96/EC

## 1.2 Definition of Measurement Categories

**CAT I:** For measurements on circuits not directly connected to the AC supply wall outlet such as protected secondaries, signal level, and limited energy circuits.

**CAT II:** For measurements performed on circuits directly connected to the electrical distribution system. Examples are measurements on household appliances or portable tools.

**CAT III:** For measurements performed in the building installation at the distribution level such as on hardwired equipment in fixed installation and circuit breakers.

**CAT IV:** For measurements performed at the primary electrical supply (<1000V) such as on primary overcurrent protection devices, ripple control units, or meters.

## 1.3 Receiving Your Shipment

Upon receiving your shipment, make sure that the contents are consistent with the packing list. Notify your distributor of any missing items. If the equipment appears to be damaged, file a claim immediately with the carrier and notify your distributor at once, giving a detailed description of any damage. Save the damaged packing container to substantiate your claim.

## 1.4 Ordering Information

**Ground Resistance Tester Model 6470-B..... Cat. #2135.01**  
*Includes carrying bag, 110/240V power adapter with US power cord, optical USB cable, rechargeable NiMH battery pack, and a USB stick with DataView® software, ground tester workbook and user manual.*

**Ground Resistance Tester Model 6470-B Kit (150 ft) ..... Cat. #2135.02**  
*Includes meter, two carrying bags, two 150 ft color-coded leads on spools (red/blue), one 30 ft lead (green), two 5 ft color-coded leads (red/blue), 110/240V power adapter with US power cord, optical USB cable, two T-shaped auxiliary ground electrodes, set of five spaded lugs, one 100 ft tape measure, rechargeable NiMH battery pack, and a USB stick with DataView® software, ground tester workbook and user manual.*

**Ground Resistance Tester Model 6470-B Kit (300 ft) ..... Cat. #2135.03**  
*Includes meter, two carrying bags, two 300 ft color-coded leads on spools (red/blue), two 100 ft color-coded leads (hand-tied, green/black), two 5 ft color-coded leads (red/blue), 110/240V power adapter with US power cord, optical USB cable, four T-shaped auxiliary ground electrodes, set of five spaded lugs, one 100 ft tape measure, rechargeable NiMH battery pack, and a USB stick with DataView® software, ground tester workbook and user manual.*

**Ground Resistance Tester Model 6470-B Kit (500 ft) ..... Cat. #2135.04**  
*Includes meter, two carrying bags, two 500 ft color-coded leads on spools (red/blue), two 100 ft color-coded leads (hand-tied, green/black), one 30 ft lead (green), two 5 ft color-coded leads (red/blue), 110/240V power adapter with US power cord, optical USB cable, four T-shaped auxiliary ground electrodes, set of five spaded lugs, one 100 ft tape measure, rechargeable NiMH battery pack, and a USB stick with DataView® software, ground tester workbook and user manual.*

## **1.4.1 Kits, Accessories and Replacement Parts**

**Test Kit for 3-Pole (3-Point) Testing (150 ft) ..... Cat. #2135.35**  
*Includes one carrying bag, two 150 ft color-coded leads on spools (red/blue), one 30 ft lead (green), two 5 ft color-coded leads (red/blue), two T-shaped auxiliary ground electrodes, set of five spaded lugs and one 100 ft tape measure.*

**Test Kit for 4-Pole (4-Point) Testing (300 ft) ..... Cat. #2135.36**  
*Includes one carrying bag, two 300 ft color-coded leads on spools (red/blue), two 100 ft color-coded leads (hand-tied, green/black), two 5 ft color-coded leads (red/blue), four T-shaped auxiliary ground electrodes, set of five spaded lugs and one 100 ft tape measure.*

**Test Kit for 4-Pole (4-Point) Testing (500 ft) ..... Cat. #2135.37**  
*Includes one carrying bag, two 500 ft color-coded leads on spools (red/blue), two 100 ft color-coded leads (hand-tied, green/black), one 30 ft lead (green), two 5 ft color-coded leads (red/blue), four T-shaped auxiliary ground electrodes, set of five spaded lugs and one 100 ft tape measure.*

**Test Kit for 3-Pole (3-Point) Testing**  
(Supplemental for 4-Pole (4-Point) Testing) ..... **Cat. #2135.38**  
*Includes one carrying bag, two 100 ft color-coded leads (hand-tied, green/black), one 30 ft lead (green), two T-shaped auxiliary ground electrodes, set of five spaded lugs and one 100 ft tape measure.*

Extra Large Classic Tool Bag ..... **Cat. #2133.73**  
Tape Measure (100 ft) ..... **Cat. #2130.60**  
Ground Tester DVD/Workbook Set..... **Cat. #2130.64**  
Set of Two, 14.5" T-shaped Auxiliary Ground Electrodes ..... **Cat. #2135.39**  
Replacement - Carrying Bag for Meter..... **Cat. #2135.40**  
Optical USB Cable..... **Cat. #2135.41**  
Inverter – 12VDC to 120VAC 200 Watt for vehicle use ..... **Cat. #2135.43**  
Replacement - Fuse, set of 5, 0.63A 250V 5x10 1.5kA..... **Cat. #2135.81**  
Rechargeable NiMH 9.6V Battery Pack ..... **Cat. #2960.21**  
Replacement - Power Adapter 110/240V & Power Cord 115V US... **Cat. #5000.13**  
Power Cord 115V US ..... **Cat. #5000.14**

## **PRODUCT FEATURES**

### **2.1 Description**

The Digital Ground Resistance Tester Model 6470-B is a portable measurement instrument designed to measure Ground Resistance, Soil Resistivity (two methods – Wenner and Schlumberger), Bonding Resistance (DC Resistance 2-Wire and 4-Wire Kelvin sensing) and Earth Coupling resistance. This direct reading tester measures from 0.01 to 99.99k $\Omega$  and is auto-ranging, automatically seeking out the optimum measurement range and test current.

Easy-to-use – simply connect the leads, select the test mode, press Start and read the results. Up to 512 test results can be stored in internal memory for later recall to the display or downloaded to a PC via DataView® software.

The large LCD is easy-to-read and indicates ground electrode resistance, test voltage, current and frequency as well as individual electrode resistance, battery status and more.

The Model 6470-B is CAT IV rated to 50V and is over voltage protected to more than 250VAC against accidental connection to live circuits. The voltage is also displayed on screen. In the event of a system fault, the Model 6470-B can withstand 250VAC.

Additional features of the Model 6470-B include a heavy-duty field case sealed against dust and water when closed (the test button is also sealed against the elements); manual and automatic test frequency selection from 40 to 513Hz; user selectable 3-Pole (3-Point) Fall of Potential or 4-Pole (4-Point) Soil Resistivity test methods and user selectable 2-Wire or 4-Wire Bond Resistance test method.

The Model 6470-B is powered by 9.6V, 3.5 Ah NiMH rechargeable batteries. An external recharger powered from 120/230V 50/60Hz is included and provides for testing while recharging. The Model 6470-B can also be vehicle powered from an optional 12V battery adapter.

The Ground Resistance Tester Model 6470-B is rugged, easy-to-use and ideal for maintenance crews performing numerous tests. It exceeds mechanical and safety specifications for shock, vibration and drop tests per IEC standards. The adjustable test frequency provides for rejection of high levels of interference, allowing it to be used under difficult conditions such as high stray currents that normally affect accuracy.

## 2.2 Key Features

- 2- and 4-Wire Bond Resistance/Continuity measurement (DC Resistance) with automatic polarity reversal
- 3-Pole (3-Point) Fall-of-Potential measurement with manual or automatic frequency selection
- 4-Pole (4-Point) Fall-of-Potential measurement for very low resistance measurements with manual and automatic frequency selection and automatic lead compensation.
- 4-Pole (4-Point) Soil Resistivity measurement with automatic calculation of Rho ( $\rho$ ) and user selection of the Wenner or Schlumberger test method
- 3-Pole (3-Point) Earth Coupling measurement
- Manual and automatic frequency scan from 40 to 513Hz for optimum test accuracy in electrically noisy environments
- Selectable test voltage of 16 or 32V up to 250mA of test current
- Auto-off power management
- Automatic recognition of all electrode connections and their resistance value
- Stores up to 512 complete test results in internal memory
- Optically isolated USB communication
- Remote set up and operation of all measurements using DataView® software supplied
- Automatic report generation
- Rechargeable NiMH batteries from wall charger or vehicle power
- Rugged dustproof and rainproof field case – IP54 rated in closed position
- Grounding standards IEC 61557 parts 4 and 5 compliant
- Includes DataView® software for data storage, real-time display, analysis, report generation and system configuration

## 2.3 Control Features

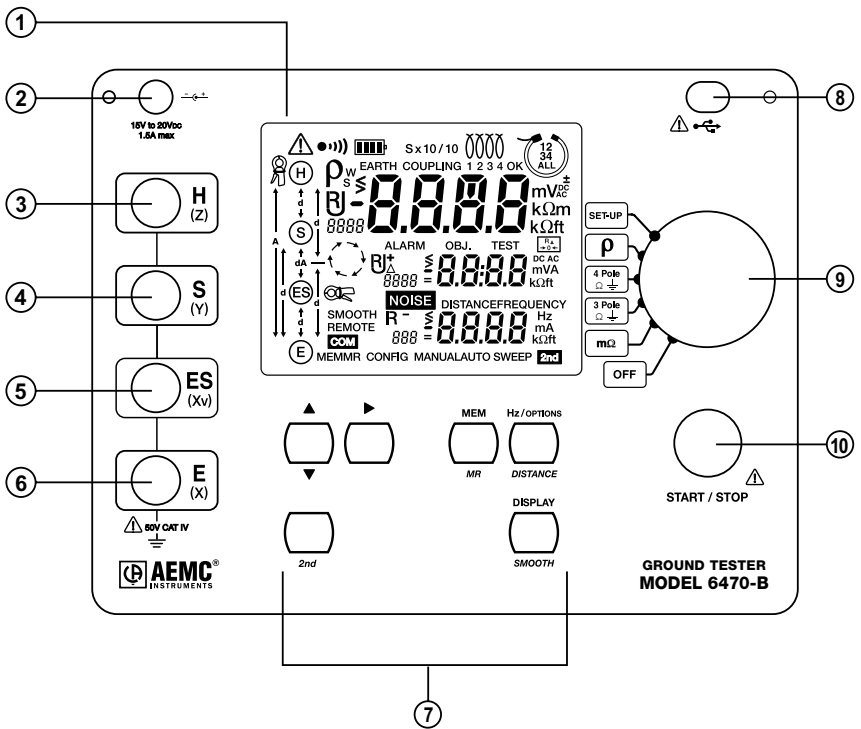

Figure 2-1

Item	Description
1	Backlit LCD Display (see §2.4)
2	Battery charging connector
3	Input terminal H (Z) - auxiliary electrode
4	Input terminal S (Y) - auxiliary electrode
5	Input terminal ES (Xv) - auxiliary electrode
6	Input terminal E (X) - grounding electrode under test
7	Six program/function buttons (see §2.5)
8	Optical interface connector for connection to a computer
9	Range selection switch
10	Start/Stop button

## 2.4 Display

The Model 6470-B's display is a custom 256 segment multi-line backlit LCD.



External voltages will be displayed only on the small displays (A2 and A3) without the view of the main display (A1). This helps to rapidly recognize that these are measurements of external voltages.

**Backlight:** The backlight turns ON automatically when entering a function and turns OFF after the function is complete. Press the **DISPLAY** button to turn it back on.



In the Set-up mode (Instrument Configuration § 4.) pressing the DISPLAY button also selects the next configurable parameter.

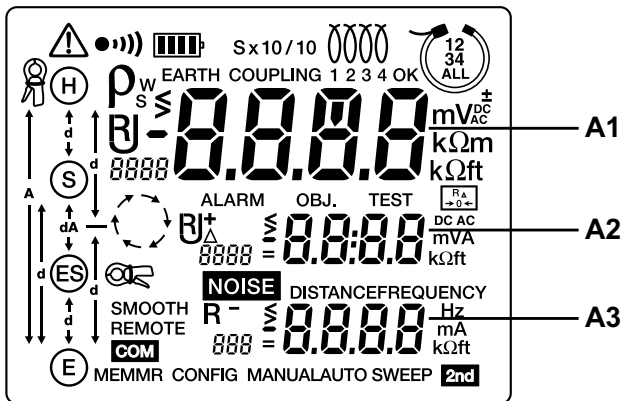









Figure 2-2

<b>A1</b>	Top main display
<b>A2</b>	Middle small display
<b>A3</b>	Bottom small display
<b>•••••)</b>	Warning buzzer is activated
<b>COM</b>	Communication port active
<b>     </b>	Indicates the battery charge condition; the segments represent the energy
<b>2nd</b>	Indicates that the secondary function of a button will be used
<b>!</b>	External voltage present - this symbol is activated when the instrument measures voltages above 60Vp

	Indicates that the measurement is running in State 2 or instrument is working
<b>MANUAL</b>	Indicates MANUAL mode - the user has to stop the measurement, otherwise the measurement keeps on running
<b>AUTO</b>	Indicates AUTO mode - measurement stops immediately after all results are available. In AUTO mode, the measurement frequency is automatically adjusted to the best available disturbance voltage rejection.
	Symbol not used in Model 6470-B
	Indicates the 2-Wire DC resistance; calculates the offset of the cable resistance into the result (5Ω max for offset value)
	Symbol not used in Model 6470-B
	Symbol not used in Model 6470-B
	Symbol not used in Model 6470-B
<b>ρ</b>	Symbolizes the soil resistivity value (Rho): W or S indicates respectively that Wenner or Schlumberger method is used for the measurement (changed by the Hz/OPTIONS button)
<b>ALARM</b>	Indicates the alarm is activated. An audible alarm will sound if the value measured is above the limit defined in the SET-UP mode.
<b>REMOTE</b>	Indicates the instrument is controlled remotely by the RS-232/USB interface. In this mode, all of the buttons and the rotary switch are inactive, except switching to the OFF position.
<b>MEM</b>	Indicates that there is recorded data in memory
<b>MR</b>	Memory recall - displayed as long as this state is active
<b>NOISE</b>	If blinking, indicates the measurement had a disturbance at the moment the measurement was started.
<b>DISTANCE</b>	If blinking, indicates the value is ready to be overwritten with a new value or that a new value will be entered instead of “- - -”. If more than one value has to be entered, the CHANGE ▲ ▼ button moves to the next one.
<b>CONFIG</b>	Indicates that the blinking value of AUTO/MANUAL mode, frequency, voltage or DC current direction can be changed.
<b>SMOOTH</b>	Optional with a push on the 2nd button - sets a digital filter active
<b>SWEEP</b>	Symbol not used in Model 6470-B
<b>FREQUENCY</b>	Indicates the test frequency
<b>OBJ:TEST</b>	Memory address

## 2.5 Button Functions

<b>START/STOP</b>	<p>Starts a measurement and compensates for lead resistance (§ 5.2.1).  A short push (&lt;2s) enables a faster measurement because there is no measurement of the auxiliary rod resistances.  A long push (&gt;2s) - until the second beep occurs - enables the measurement of all auxiliary rod resistances.  Measurement stops automatically (AUTO) or is stopped by pressing this button again (MANUAL).</p>
<b>2<sup>nd</sup></b>	<p>Selects the second function highlighted in yellow under the buttons.</p>
	<p>Increases or decreases the value of the flashing parameter displayed or selects the next parameter. Press the button for a longer time to increase the change of value speed at a faster rate.</p>
	<p>Selects the parameter to be modified or moves the cursor to the right.</p>
<b>MEM/MR</b>	<p>MEM: Stores measurements to memory (§ 7)  MR: Retrieves measurements from memory.</p>
<b>DISPLAY / SMOOTH</b>	<p>DISPLAY: Displays all parameters of a measurement.  SMOOTH: Smooths the display of measurement providing a more stable result.</p>
<b>Hz/OPTIONS/ DISTANCE</b>	<p>Hz/OPTIONS: Enables configuration of measurement functions.  DISTANCE: Available for soil resistivity and V potential measurements. It allows the setting of values of distances used for Rho (<math>\rho</math>) calculation.</p>

## **SPECIFICATIONS**

### **3.1 Reference Conditions**

<b>Influencing Parameters</b>	<b>Reference Values</b>
Temperature	68°F ± 5.5°F (20°C ± 3°C)
Relative Humidity	45 to 55% RH
Power Supply	9 to 11.2V
Frequency Range of Input Signal	0 to 440Hz
Capacitance Parallel to Input Resistance	0 uF
Electric Field	<1 V/m
Magnetic Field	< 40 A/m

*In the following sections, the intrinsic error is defined under the reference conditions and the operating error under the operating conditions in accordance with IEC 61557 (1.4 and 5).*

### **3.2 Electrical**

#### **3.2.1 Frequency Measurements**

**Measuring Method:** Digital with a sampling frequency of 4028Hz, low pass, FFT. The frequency of the strongest spectral component is displayed.

**Measuring Rate:** Display updates approx. 3 times per s.

<b>Measurement Range</b>	<b>5 to 450Hz</b>
Resolution	1Hz
Operating error	± 2Hz
Min. input voltage	10mV

#### **3.2.2 Voltage Measurements**

Overvoltages up to 75Vrms are displayed as ">65V". Permanent overvoltages between 70 and 75V at terminals **H (Z)** and **E (X)** can cause overheating of the overvoltage protection varistor.

Voltages of more than 75Vrms lead to error message 31 (excessive external voltage) or 32 (voltage measurement overrange).

If terminals **H (Z)** and **E (X)** are put into contact with the line voltage, the protection fuse will blow.

## External Voltage Measurements

**Measuring Method:** Digital by sampling at 4028Hz, low pass filter, FFT.  
The frequency of the strongest spectral component is displayed.

**Measuring Rate:** Display updates approx. 3 times per s.

Measured Range	0.00 to 9.99V	10 to 65V
Resolution	0.01V	0.1V
Intrinsic error	$\pm (2\% + 1\text{ct})$	
Operating error	$\pm (5\% + 1\text{ct})$	
Input impedance $Z_{H-E}, Z_{S-E} (Z_{S-ES})$	1.2M $\Omega$	
Operating frequency	DC and 15 to 440Hz	

### 3.2.3 DC Resistance Measurements

**Measuring Method:** Voltage/Current measurement (Standard EN 61557 part 4)

**Nominal Output Voltage:** 16VDC (if resistance < 22 $\Omega$  the output voltage is reduced to 10VDC)

**Max Output Current:** > 200mADC for resistances < 20 $\Omega$

**Max Overload (permanent):** 50Vrms (protection up to 250V is guaranteed)

**Max Inductive Load:** 2 H

**Max Interfering Voltage:** 60Vpeak > 10Hz

**Time for Auto Range Selecting:** approx 5 s

**Measuring Time:** 8 s with automatic polarity inversion

**Measuring Rate:** 3 per s in manual mode

**Lead Compensation:** Possible from 0 to 5 $\Omega$

**Alarm Setting:** ">" or "<" from 1 to 999 $\Omega$  (max 3 digits)

### 2-Pole m $\Omega$ measurement

Measurement Range	0.12 to 9.99 $\Omega$	10.0 to 99.9 $\Omega$	100 to 999 $\Omega$	1.00 to 9.99k $\Omega$	10.0 to 99.9k $\Omega$
Resolution	0.01 $\Omega$	0.1 $\Omega$	1 $\Omega$	10 $\Omega$	100 $\Omega$
Intrinsic error	$\pm (2\% + 2\text{cts})$				
Operating error	$\pm (5\% + 3\text{cts})$				

#### 4-Pole mΩ measurement

Measurement Range	0.020 to 9.999Ω	10.00 to 99.99Ω	100.0 to 999.9Ω	1.000 to 9.999kΩ	10.00 to 99.99kΩ
Resolution	0.001Ω	0.01Ω	0.1Ω	1Ω	10Ω
Intrinsic error	± (2% + 2cts)				
Operating error	± (5% + 5cts)				

### 3.2.4 AC Earth/Ground Resistance Measurements

**Measuring Method:** Voltage/Current measurement (EN 61557 part 5)

**Open Circuit Voltage:** 16 or 32Vrms square wave (if current > 240mA the output voltage is reduced to 10Vrms)

**Test Frequency:** Selectable from 41 to 513Hz (see table in § 6.2)

**Short Circuit Current:** > 200mAAC

**Noise Suppression:** > 80 dB for frequencies 20% or more above or below the test frequency

**Max. Overload:** 250Vrms

**Max. Value for  $R_H$  &  $R_S$ :** 100kΩ

**Measuring Time: Short push on START:** approx. 7 s for first value of  $R_E$  at 128Hz, then 3 measurements per s.

**Long push on START:** approx. 15 s for first value of  $R_E$  at 128Hz, then 3 measurements per s.

The following error indications refer to reference conditions with a test voltage of 32V, test frequency of 128Hz,  $R_H$  and  $R_S = 1kΩ$ , no external voltage.

The operating error of AC resistance measurements can be less than that specified for voltage or current because frequency characteristics of the voltage channel are matched to those of the current channel.

#### Measurement of auxiliary electrodes $R_H$ , $R_S$ , $R_{ES}$ , $R_E$

Measurement Range	0.14 to 9.99Ω	10.0 to 99.9Ω	100 to 999Ω	1.00 to 9.99kΩ	10.0 to 99.9kΩ
Resolution	0.1Ω	0.1Ω	1Ω	10Ω	100Ω
Operating error	± (10% + 2cts)				

The **START** button must be pressed for more than 2 s. For frequencies between 41 and 256Hz, the resistance of the auxiliary earth electrodes is measured at the test frequency set. At higher frequencies the resistance is measured at 256Hz.

### 3-Pole earth resistance measurement $R_E$

Measurement Range	0.09 to 9.99 $\Omega$	10.0 to 99.9 $\Omega$	100 to 999 $\Omega$	1.00 to 9.99k $\Omega$	10.0 to 99.9k $\Omega$
Resolution	0.01 $\Omega$	0.1 $\Omega$	1 $\Omega$	10 $\Omega$	100 $\Omega$
Intrinsic error	$\pm (2\% + 1\text{ct})$				

Operating conditions: $R_E < 3 \times R_H$ , $U_{OUT} = 32V$			Operating error for $R_E$
Values for $R_H$ , $R_S$ and $R_E$		Frequency (Hz)	
$(R_H + R_S) / R_E < 3000$	$R_H \geq 0\Omega$ , $R_S \leq 3k\Omega$	41 to 513	$\pm (3\% + 2\text{cts})$
	$R_H > 3k\Omega$ , $R_S \leq 30k\Omega$	41 to 513	$\pm (10\% + 2\text{cts})$
$(R_H + R_S) / R_E < 5000$	$R_H > 30k\Omega$ , $R_S < 100k\Omega$	41 to 128	$\pm (10\% + 3\text{cts})$

**Note:** For a test voltage  $U_{OUT}$  of 16V, halve the value for  $R_H$ .

### 4-Pole earth resistance measurement $R_E$

Measurement Range	0.011 to 9999 $\Omega$	10.00 to 99.99 $\Omega$	100.0 to 999.9 $\Omega$	1.000 to 9.999k $\Omega$	10.00 to 99.99k $\Omega$
Resolution	0.001 $\Omega$	0.01 $\Omega$	0.1 $\Omega$	1 $\Omega$	10 $\Omega$
Intrinsic error	$\pm (2\% + 1\text{ct})$				

Operating conditions: $R_E < 3 \times R_H$ , $U_{OUT} = 32V$			Operating error for $R_E$
Values for $R_H$ , $R_S$ and $R_E$		Frequency (Hz)	
$(R_H + R_S) / R_E < 3000$	$R_H \geq 0\Omega$ , $R_S \leq 3k\Omega$	41 to 513	$\pm (3\% + 2\text{cts})$
	$R_H > 3k\Omega$ , $R_S \leq 30k\Omega$	41 to 513	$\pm (10\% + 2\text{cts})$
$(R_H + R_S) / R_E < 5000$	$R_H > 30k\Omega$ , $R_S < 100k\Omega$	41 to 128	$\pm (10\% + 3\text{cts})$

**Note:** With a test voltage  $U_{OUT}$  of 16V, halve the value of  $R_H$ .

## 3.2.5 Soil Resistivity Measurement $\rho$

**Measuring Method:** Voltage/Current measurement (EN 61557 part 5)

**Open Circuit Voltage:** 16 or 32Vrms square wave

**Test Frequency:** Selectable from 41 to 128Hz (see table in § 6.2)

**Short Circuit Current:** > 200mAAC

**Noise Suppression:** > 80 dB for frequencies 20% or more above or below the test frequency

**Max. Overload:** 250Vrms

**Max.Value for  $R_H, R_S, R_{ES}, R_E$ :** 100k $\Omega$

**Calculation Formula, Wenner:**  $\rho_W = 2\pi d R_{S-ES}$

**Calculation Formula, Schlumberger:**  $\rho_S = (\pi (d^2 - (A/2)^2) / A) R_{S-ES}$

**Maximum Value of  $\rho$ :** 999k $\Omega$ m (display in k $\Omega$ ft is not possible)

**Measuring Time: Short push on START:** approx. 8 s for first value of  $R_{S-ES}$  at 128 Hz, then 3 measurements per s.

**Long push on START:** approx. 20 s for first value of  $R_{S-ES}$  at 128 Hz, then 3 measurements per s.

Measurement Range	0.00 to 9.99 $\Omega$	10.0 to 99.9 $\Omega$	100 to 999 $\Omega$	1.00 to 9.99k $\Omega$	10.0 to 99.9k $\Omega$
Resolution	0.01 $\Omega$	0.1 $\Omega$	1 $\Omega$	10 $\Omega$	100 $\Omega$
Intrinsic error	$\pm (2\% + 1ct)$				

The intrinsic error specified refers to reference conditions with a test voltage of 32V, test frequency of 128Hz,  $R_{\rho-H}, R_{\rho-S}, R_{\rho-ES}$  and  $R_{\rho-E} = 1k\Omega$ , no external voltage.

Operating conditions : $R_{S-ES} < 3 \times R_{\rho-H}$ and:	Operating error for $R_{S-ES}$
$R_{\text{electrode}} \leq 100k\Omega$ $R_{\text{electrode}} / R_{S-ES} \leq 2000$	$\pm (7\% + 2cts)$
$R_{\text{electrode}} \leq 50k\Omega$ $R_{\text{electrode}} / R_{S-ES} \leq 10,000$	$\pm (15\% + 3cts)$
$R_{\text{electrode}} \leq 10k\Omega$ $R_{\text{electrode}} / R_{S-ES} \leq 20,000$	$\pm (20\% + 1ct)$

$R_{\text{rod}}$  is the resistance of the earth rods  $R_{\rho-E}, R_{\rho-ES}, R_{\rho-E}, R_{\rho-H}$  assumed to be identical.

**Note:** With a test voltage  $U_{\text{OUT}}$  of 16V, halve the value of  $R_{\text{rod}}$ .

**Measurement of Auxiliary Electrodes  $R_{\rho-H}, R_{\rho-S}, R_{\rho-ES}, R_{\rho-E}$**

Measurement Range	0.14 to 9.99 $\Omega$	10.0 to 99.9 $\Omega$	100 to 999 $\Omega$	1.00 to 9.99k $\Omega$	10.0 to 99.9k $\Omega$
Resolution	0.1 $\Omega$	0.1 $\Omega$	1 $\Omega$	10 $\Omega$	100 $\Omega$
Operating error	$\pm (10\% + 2cts)$				

The **START** button must be pressed for more than 2s. For frequencies between 41 and 128Hz, the resistance of the auxiliary earth electrodes is measured at the test frequency set. At higher frequencies the resistance is measured at 128Hz.

### 3.3 Data Storage

**Memory Capacity:** 512 test results (64kB)

**Communication:** Optically isolated USB

### 3.4 Power

**Power Source:** Rechargeable 9.6V, 3.5Ah NiMH Battery Pack

At the middle and bottom of the display you will see one of the following messages:

bAtt CHRg	Fast charging is active (normal state)
bAtt LOW	Battery voltage is too low for a fast charge - charging at a lower current
bAtt	Battery voltage is too high for a fast charge - charging at a lower current
bAtt HOt	Battery is too warm for a fast charge (>40°C) - charging at a lower current
bAtt COLd	Battery is too cold for a fast charge (<0°C) - charging at a lower current
bAtt FULL	Battery is full - switch to trickle charging

**Power Supply:** 110/220, 50/60Hz external charger with 18V<sub>DC</sub>, 1.9A output or 12V<sub>DC</sub> vehicle power



In this case the low-potential of the vehicle's 12V outlet is at the potential of terminals **E (X)** and **ES (Xv)** of the ground tester. For safety reasons, do not connect or use the unit if there is a possibility that voltages at **E (X)** or **ES (Xv)** could exceed 32V.

**Fuse:** 0.63A, 250V, 5x20mm, 1.5kA

**Battery Life:**

Function	Power consumed	Typical number of measurements <sup>(1)</sup>
Device off	< 5 mW	—
Voltage Measurement	1.5 W	4500
mΩ <sup>(2)</sup>	4.9 W	1500
3-Pole, 4-Pole <sup>(3)</sup>	4.9 W	1500
ρ <sup>(4)</sup>	4.9 W	1500

(1): Measurements in automatic mode at 25-s intervals

(2): With R = 1Ω

(3): With R<sub>H</sub> + R<sub>E</sub> = 100Ω

(4): With R<sub>H</sub> + R<sub>S</sub>-E<sub>S</sub> = 100Ω

## 3.5 Mechanical

**Dimensions:** 10.7 x 9.76 x 5.12" (272 x 248 x 130mm)

**Weight:** 7 lbs (3.2kg) approx

**Case Material:** ULV0 Polypropylene

**Terminals:** 4mm recessed banana jacks

**Case Protection:** EN 60529 - IP53 (cover closed)

**Drop Test:** Per EN 61010-1

**Vibration Test:** Per EN 61557-1

## 3.6 Environmental

**Operating Temperature:** 32° to 113°F (0° to 45°C); 0 to 90% RH

**Specified Operating Temperature<sup>(1)</sup>:** 0° to 95°F (0° to 35°C); 0 to 75% RH

**Storage Temperature:** -40° to 158°F (-40° to 70°C); 0 to 90% RH

**Altitude:** < 3000m

(1): This range corresponds to the one defined by standard EN 61557, for which an operating error including the quantities of influence is defined. When the device is used outside this range, 1.5%/10°C and 1.5% between 75 and 90% RH must be added to the operating error.

## 3.7 Safety

### Electromagnetic Compatibility

This instrument satisfies the EMC and LVD directives required for the CE marking and product standard IEC 61326-1 (Ed. 97) + A1 (Ed. 98).

- Immunity in industrial environment
- Emissions in residential environment.

Electrical safety according to EN 61010-1 (Ed. 2 of 2001)

Measurement according to EN 61557 (Ed. 2 of 2007) parts 1, 4 and 5.

CAT IV, 50V

Pollution Degree 2

*\*Specifications are subject to change without notice*

# OPERATION



For detailed information regarding ground resistance testing, see the *Understanding Ground Resistance Testing Workbook CD* that was included with the instrument.

---

## 4.1 General Operating Instructions

The Model 6470-B has two operating modes:

- **Automatic** mode for routine applications.
- **Manual (Expert)** mode in which the user can change the parameters of the measurement functions.



Fully charge the battery before the first use (see § 9.4)

---

### 4.1.1 Automatic Mode

- Set the switch to the desired function.
- Make the connections appropriate to the function.
- Press the **START/STOP** button. The instrument takes the measurement and stops automatically.
- Read the measurement result on the display and the relevant parameters using the **DISPLAY** button.
- To save the information in memory, use the **MEM** button (see § 7.1).

### 4.1.2 Manual (Expert) Mode

- Set the switch to the desired function.
- Make the connections appropriate to the function.
- Select **MANUAL** mode.
- Choose various measurement parameters using the **Hz/OPTIONS** button.
- Press the **START/STOP** button. The measurement frequency or the direction of the current (resistance measurement) can be changed during the measurement. To view the impact upon the measurement and the parameters relevant to the measurement use the **DISPLAY** button.

- When the measurement results are acceptable, stop the measurement by pressing the **START/STOP** button.
- View the result on the display and toggle through the relevant parameters using the **DISPLAY** button.
- To record the information into memory, use the **MEM** button (see § 7).

## 4.2 Instrument Configuration (SET-UP mode)

To configure the Model 6470-B parameters, turn the rotary switch to **SET-UP**:

- All the segments on the display are activated for 1 second and then the “PUSH button” message appears on the display.
- Various parameters are accessible by pressing the corresponding button.
- The number or symbol which can be modified flashes. These are changed using the **SELECT button [▶]** and **CHANGE buttons [▲ ▼]**.
- **To exit SET-UP**, turn the rotary switch to another position.
- All of the parameters that are modified are permanently saved until a new instrument configuration is performed.

Parameter to be modified	Button	Possible values	Default values
Distance unit	DISPLAY (1 <sup>st</sup> press)	m (meter) or ft (feet)	m
Alarm (for mΩ and 2-wire measurements only)	DISPLAY (2 <sup>nd</sup> press)	ON / OFF direction (< or >) value (1 to 999Ω)	OFF > 2Ω
Buzzer	DISPLAY (3 <sup>rd</sup> press)	ON / OFF	ON
Modbus address	DISPLAY (4 <sup>th</sup> press)	1 to 247	1
Date	Hz/OPTIONS (1 <sup>st</sup> press)	yyyy.mm.dd*	Current date*
Time	Hz/OPTIONS (2 <sup>nd</sup> press)	hh : mm*	Current time*
Baud	Hz/OPTIONS (3 <sup>rd</sup> press)	9.6k / 19.2k / 38.4k	9.6 k bits
Default configuration	Hz/OPTIONS (4 <sup>th</sup> press)	yes / no	yes
Memory used	MEM (1 <sup>st</sup> press)	000 to 512 (total number of locations)	000 on 512

\*International format date and time only

## **AUTOMATIC MODE**

**!** **VOLTAGE CHECK:** The tester first checks for possible interference. If there is an external voltage of more than 42V, the warning triangle  $\triangle$  will be displayed. If measurements are being performed in **AUTO** mode and a disturbance frequency is detected, the tester will automatically look for a frequency that is different from the default 128Hz.

---

### **5.1 Switching the Test Voltage**

Available in all functions except  $m\Omega$ .

If necessary, the test voltages can be switched to either 16 or 32V as follows:

- Press the **Hz/OPTIONS** button, then press it again to make the output voltage ( $U_{out}$ ) blink.
- Use the **▶** button to switch to 16 or 32V, then press **Hz/OPTIONS** again.

This setting is retained when the unit is turned off.

### **5.2 Resistance Measurement $m\Omega$ (2-Wire)**

**!** **WARNING:** Before performing the resistance test, verify that the sample under test is not energized.

---

1. Set the switch to  $m\Omega$ .
2. Connect the resistance to terminals **H (Z)** and **E (X)**.

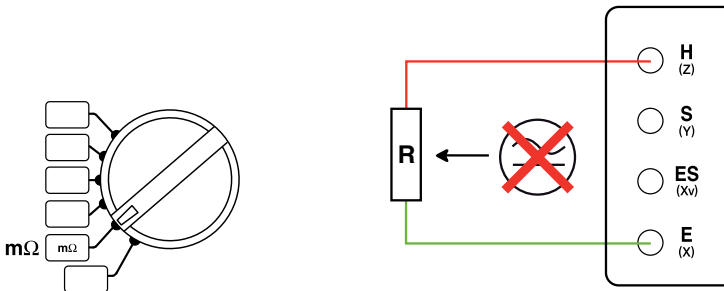

3. The 6470-B makes a measurement with a positive current (R+), then reverses the direction of the current and makes another measurement with negative (R-).

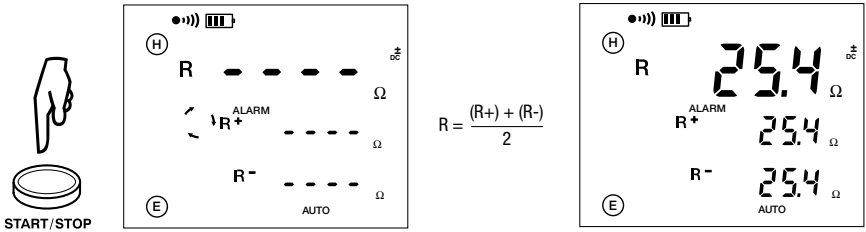

4. To display the measurement parameters, press **DISPLAY** several times.

The device displays the following parameters:

R+, R-, +U<sub>H-E</sub>, +I<sub>H-E</sub>, -U<sub>H-E</sub>, -I<sub>H-E</sub>, U-Act (U<sub>H-E</sub> and its frequency) and R<sub>Δ0</sub> if there is compensation for the measurement leads.

### 5.2.1 Lead Compensation Measurement

Lead compensation subtracts the resistance of the test leads from the measured result.

- Short the two measurement leads connected to **H (Z)** and **E (X)** terminals.
- Press the **2nd** button, then the **START/STOP** button to start the measurement.
- This value will be deducted from all resistance values measured thereafter until the rotary switch is turned to another function.

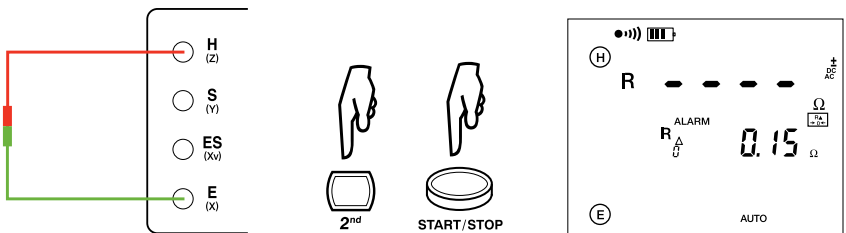

 appears on the display after the compensation value has been measured.



If the compensation resistance is > 5Ω, or if the leads are not shorted when the measurement is started, the value of compensation will be canceled.

## 5.2.2 Alarm Function

This function is active only for 2-Pole resistance measurements. By default, the visual alarm (ALARM symbol flashes) and the audible alarm (buzzer sounds for a few seconds) are triggered when  $R < 2\Omega$ .

This threshold can be changed using the **SET-UP** function:

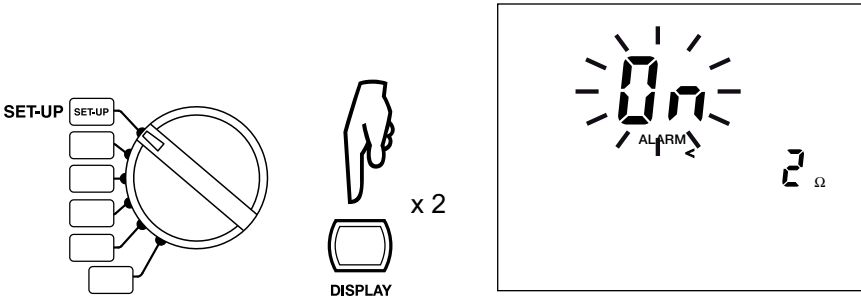

Turn the alarm  
ON or OFF

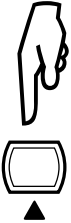

Access the  
type of alarm

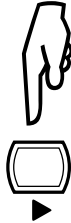

Choose a low (<) or  
high (>) alarm

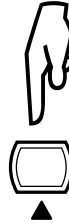

Set the value of the alarm  
between 1 and 999Ω

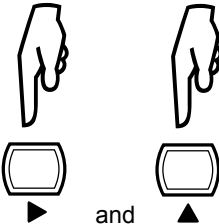

Complete the adjustment  
of the alarm setting

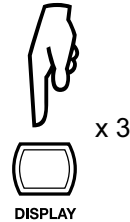

### 5.3 Resistance Measurement mΩ (4-Wire)

This measurement is used to improve the resolution (10x better than the 2-Wire measurement) for low resistance values.

To perform a 4-Wire measurement:

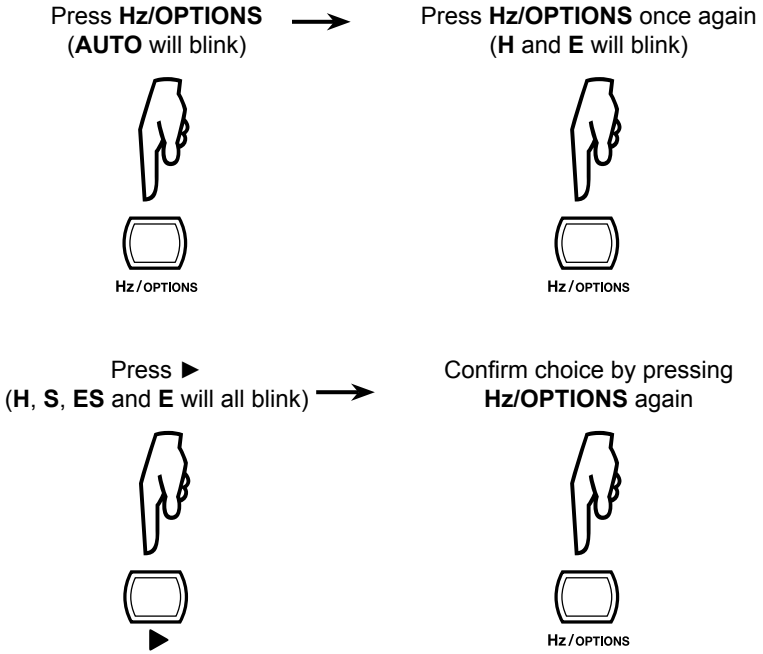

**WARNING:** Before performing the resistance test, verify that the sample under test is not energized.

1. Set the switch to **mΩ**.
2. Connect the resistance to all 4 terminals.

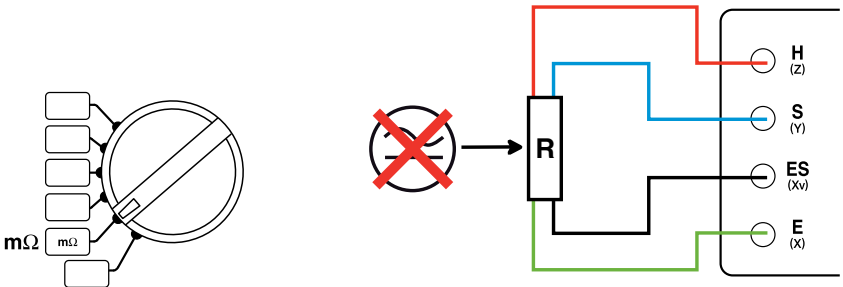

3. Start the measurement by pressing the **START/STOP** button.

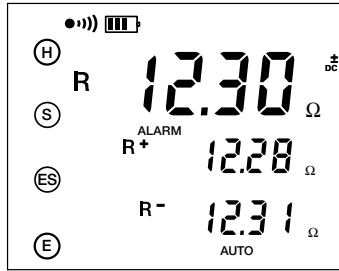

4. To display the measurement parameters, press **DISPLAY** several times. The device displays the following parameters:  
R+, R-, +U<sub>H-E</sub>, +I<sub>H-E</sub>, -U<sub>H-E</sub>, -I<sub>H-E</sub>, U-Act (U<sub>H-E</sub> and its frequency)

## 5.4 Earth/Ground Measurement (3-Pole)

This function is used to measure an earth (ground) resistance with 2 auxiliary electrodes.

There are several measurement methods, the full and simplified (62% method) will be discussed in this section.

### 5.4.1 62% Method

1. Set the switch to .
2. Place electrodes **H (Z)** and **S (Y)** to form a straight line with the earth electrode under test.

The distance between electrode **S (Y)** and the earth electrode is 62% of the distance between electrode **H (Z)** and the earth electrode; the distance between the electrodes **H (Z)** and **E (X)** should be 8 to 10 times the depth of the rod you are testing.

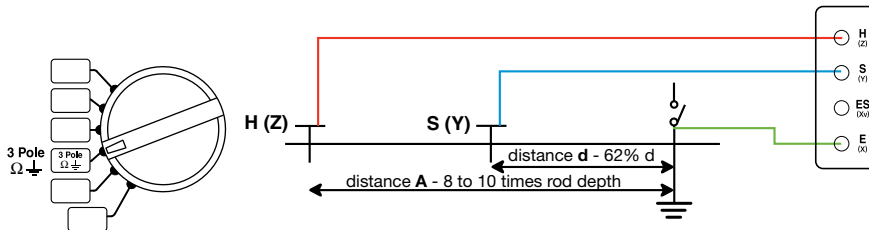

In order to avoid electromagnetic interference, it is best to unwind the full length of each cable from the reel, to keep the cables as far apart as possible on the ground,

taking care not to form loops, and to avoid placing the cables near or parallel to metallic conductors (cables, rails, fences, etc.).

Connect the cables to terminals **H (Z)** and **S (Y)** (red and blue respectively); disconnect the earth strap from the rod under test, then connect terminal **E** (green) to the rod or electrode system to be tested.

3. Press the **2nd** button, then the **DISTANCE** button. The "hundredths" will blink.

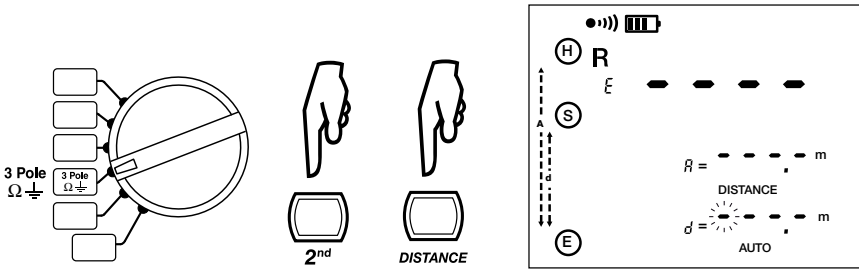

4. To modify the hundredths (of meters or feet), press the **▲** button until the desired digit is displayed (0-9).

5. To select and modify the tens, press the **▶** button and then the **▲** button until the desired digit is displayed (0-9).

6. To select and modify the units and tenths of a unit, press the **▶** button and then the **▲** button until the desired digits are displayed (0.0-9.9).

7. To terminate the programming of distance, press the **2nd** button and then the **DISTANCE** button.

It is also necessary to program distance **A**. This is done in the same way as for distance **d**.

8. Start the measurement by pressing the **START/STOP** button.

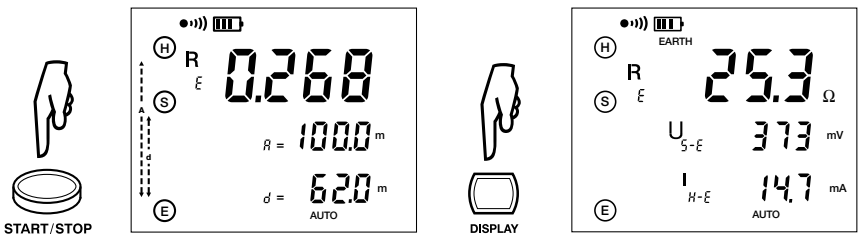

9. To display the measurement parameters, press **DISPLAY** several times.

The device displays the following parameters:

$R_E$ ,  $U_{S-E}$ ,  $I_{H-E}$ , U-Act ( $U_{H-E}$  and its frequency,  $U_{S-E}$  and its frequency).

To measure the resistances of auxiliary electrodes **H (Z)** and **S (Y)**, or if the resistance of the electrodes is too high (see § 10.1), start the measurement with a long press of the **START/STOP** button.

$R_H$ ,  $R_S$  will be displayed.

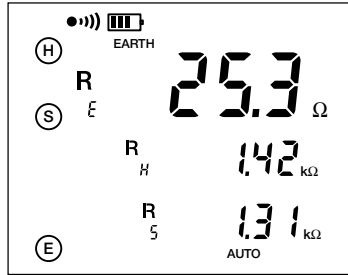
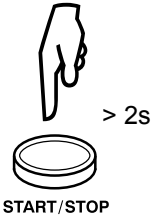

**NOTE:** Repeat the process at 52% and at 72% for the S electrode.

### 5.4.2 Full Method

A more thorough measurement can be obtained by taking measurement by moving the **S (Y)** auxiliary electrode every 10% between **H (Z)** and **E (X)** and plotting the results. A distinct plateau should result as shown below.

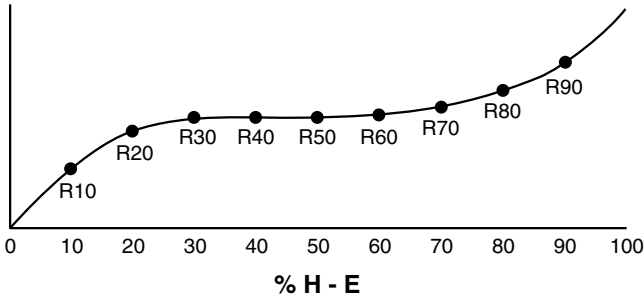

Take the average of the 3 or 4 readings on the plateau to obtain the earth electrode resistance.

$$R = \frac{R_{40} + R_{50} + R_{60} + R_{70}}{4}$$

### 5.4.3 Recommendations for a Reliable Measurement

#### Moving the Auxiliary Electrodes

Move electrode **S (Y)** towards electrode **H (Z)** by a distance equal to 10% of **d** and make another measurement. Then move electrode **S (Y)** again by a distance equal to 10% of **d**, but towards the earth electrode.

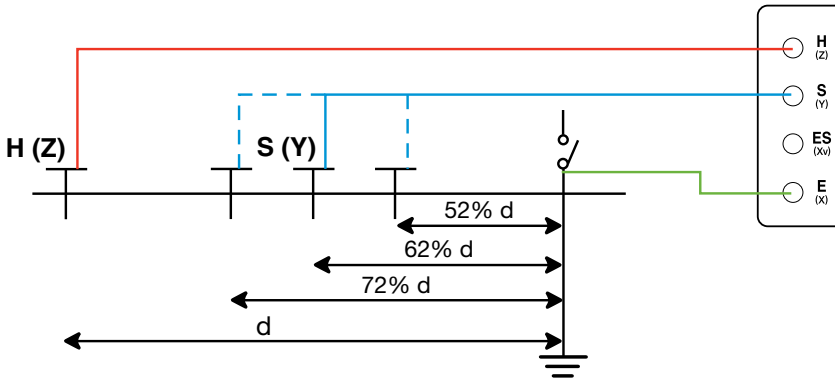

The three measurement results should be the same to within a few percent. If this is the case, the measurement is valid.

If not, electrode **S (Y)** is in the zone of influence of the earth electrode. It will be necessary to increase distance **d** for the **H (Z)** auxiliary electrode and repeat the measurements.

#### Positioning of the Auxiliary Electrodes

To make sure that your earth measurements are not distorted by interference, we recommend repeating the measurement with the auxiliary electrodes placed at a different distance and in another direction (for example, rotated 90° from the first alignment).

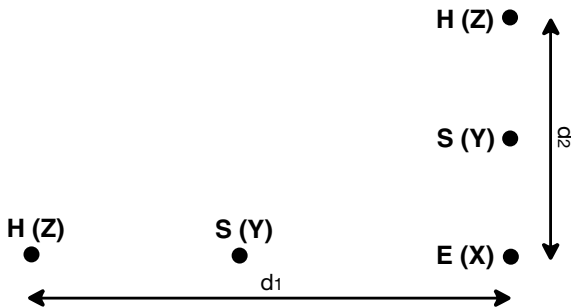

If you find the same values, your measurement is reliable. If the measured values are substantially different, it is likely that they were influenced by earth currents or a groundwater source. It may be useful to drive the electrodes deeper and/or wet the ground near them to reduce their contact resistance with the soil.

Avoid routing the connecting cables of the earth electrodes near or parallel to other cables (transmission or supply), metallic conductors, rails, or fences: high test frequencies may cause cross-talk and affect the measurements.

## 5.5 Earth/Ground Measurement (4-Pole)

This function is suited to the measurement of very low earth resistances. It provides better resolution (10x better than 3P measurement) and there is no need to compensate for the resistance of the measurement leads.

1. Set the switch to .
2. Place electrodes **H (Z)** and **S (Y)** at least 30m apart.

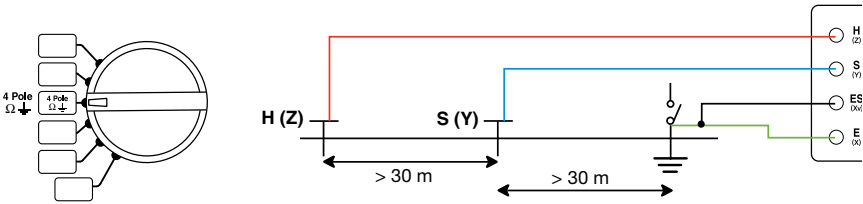

In order to avoid electromagnetic interference, it is best to unwind the full length of each cable from the reel, to keep the cables as far apart as possible on the ground, taking care not to form loops, and to avoid placing the cables near or parallel to metallic conductors (cables, rails, fences, etc.). Connect the cables to terminals **H (Z)** and **S (Y)**; disconnect the earth strap from the rod under test, then connect terminals **E (X)** and **ES (Xv)** to the earth electrode to be tested.

3. Start the measurement by pressing the **START/STOP** button.

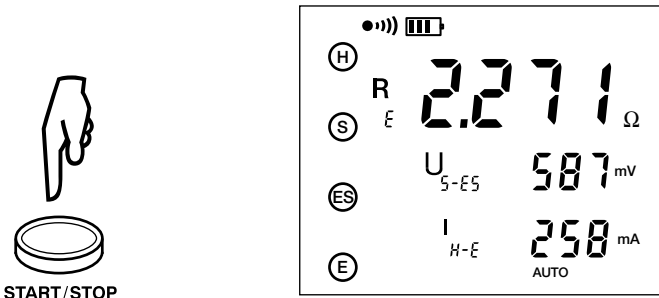

4. To display the measurement parameters, press **DISPLAY** several times.

The device displays the following parameters:

$R_E$ ,  $U_{S-E}$ ,  $I_{H-E}$ , U-Act ( $U_{H-E}$  and its frequency,  $U_{S-E}$  and its frequency).

To measure the resistances of auxiliary electrodes **H (Z)** and **S (Y)**, or if the resistance of the electrodes is too large (see § 10.1), start the measurement with a long press of the **START/STOP** button.

$R_H$ ,  $R_S$ ,  $U_{H-E}$  will be displayed.

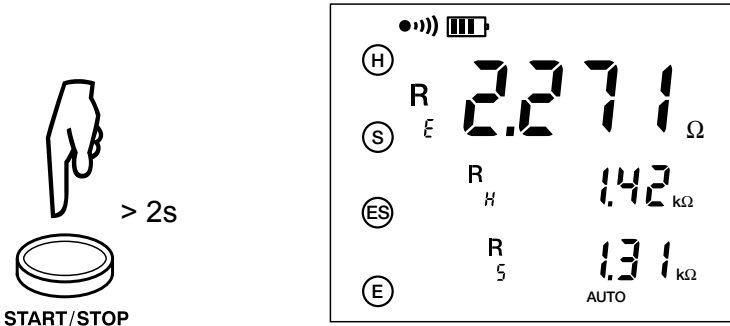

We recommend repeating the measurement with the auxiliary electrodes placed at a different distance and in another direction (see § 5.4.3).

## 5.6 Soil Resistivity Measurements ( $\rho$ Position)

To measure the resistivity of the soil, two measurement methods are possible: **Wenner** and **Schlumberger**

The difference between the two methods lies in the positioning of the electrodes. By default, the device selects the Wenner method. The Schlumberger method, which allows you to move only two measurement electrodes rather than three, is better suited for measuring soil resistivity at multiple depths.

The soil resistivity measurement with different distances  $d$ , and therefore in different layers (in depth) of the soil, can be used to establish resistivity profiles of the soil in question, which can be useful for geological analysis, the exploration of deposits, hydrological studies, etc., and to determine the location of an earth electrode.

### 5.6.1 Advantages and Disadvantages of Wenner and Schlumberger

SCHLUMBERGER		WENNER	
Advantage	Disadvantage	Advantage	Disadvantage
Need to move the two potential electrodes ES (Xv) and S (Y) only for most readings. This can significantly decrease the time required to acquire a sounding			All four electrodes, the two current E (X) and H (Z) and the two potential ES (Xv) and S (Y) must be moved equally to acquire each reading.
	Because the potential electrode spacing is small compared to the current electrode spacings, higher meter sensitivity is required.	Potential electrode spacing increases as current electrode spacing increases. Less sensitive meters may be used.	
Because the potential electrodes remain in fixed locations, the effects of the near surface lateral variations in resistivity are reduced.			Because all electrodes are moved for each reading, this method can be more susceptible to near-surface, lateral, and variations in resistivity. These near surface lateral variations could potentially be misinterpreted in terms of depth variations in resistivity.
	In general, interpretations based on DC soundings will be limited to simple, horizontal; layered structures		In general, interpretations based on DC soundings will be limited to simple, horizontal; layered structures.

Source: DC Resistivity - T. Boyd

## 5.6.2 Changing the Measurement Method

1. Set the switch to  $\rho$ .
2. Press the **Hz/OPTIONS** button. "AUTO" will blink.

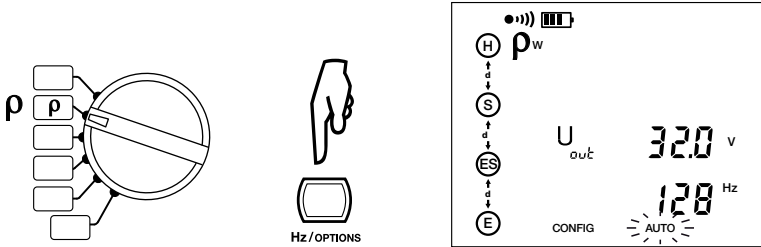

3. Press the **Hz/OPTIONS** button again. "W" will blink.
4. Press the  $\blacktriangleright$  button to change to the Schlumberger method.
5. To confirm and exit, press the **Hz/OPTIONS** button twice.

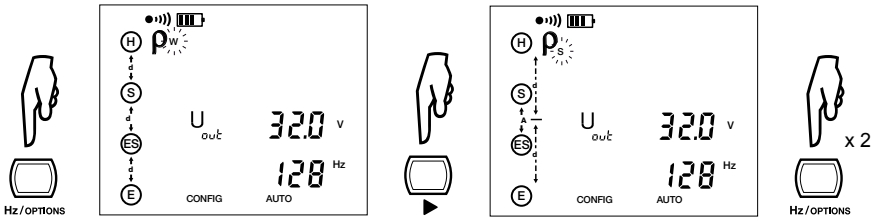

To switch back to the Wenner method, simply repeat this procedure.

The last measurement method selected (Wenner or Schlumberger) is stored in memory when the device is switched off.

## 5.6.3 Programming the Distance for Electrode Placement

The distance can be programmed before or after the measurement. If it is not programmed, only the value of  $R_{S-ES}$  will be displayed, since the value of  $\rho$  remains indeterminate.

1. Set the switch to  $\rho$ .
2. Press the **2nd** button, then the **DISTANCE** button. The "hundredths" will blink.

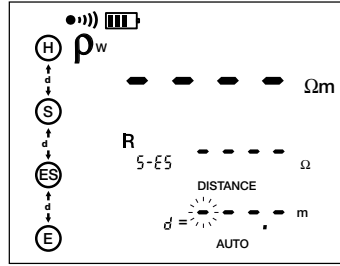
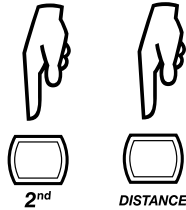
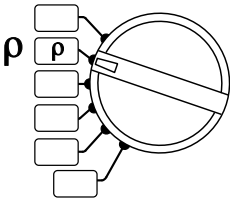

3. To modify the hundredths (of meters or feet), press the ▲ button until the desired digit is displayed (0-9).
4. To select and modify the tens, press the ► button and then the ▲ button until the desired digit is displayed (0-9).
5. To select and modify the units and tenths of a unit, press the ► button and then the ▲ button until the desired digits are displayed (0.0-9.9).
6. To terminate the programming of distance, press the **2nd** button and then the **DISTANCE** button.

In the case of the Schlumberger method, it is also necessary to program distance **A**. This is done in the same way as for distance **d**.

### 5.6.4 Wenner Method

1. Set the switch to .
2. Place the 4 earth electrodes on a straight line, at a distance **d** from one another and at a depth **p** < 1/3 **d**. Distance **d** must be between 2 and 30m.
3. Connect the cables to the electrodes, then to terminals **H (Z)**, **S (Y)**, **ES (Xv)**, and **E (X)** in sequence.
4. Program the distance into the instrument as described in § 5.6.3.

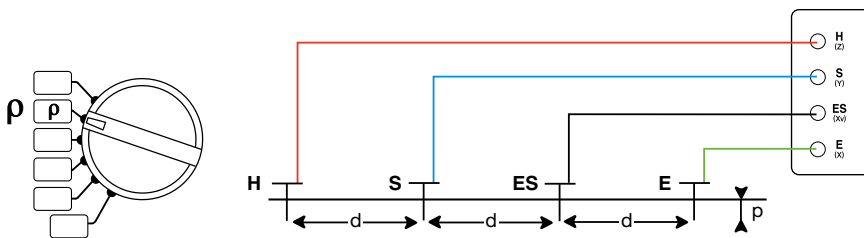

In order to avoid electromagnetic interference, it is best to unwind the full length of each cable from the reel, to keep the cables as far apart as possible on the ground, taking care not to form loops, and to avoid placing the cables near or parallel to metallic conductors (cables, rails, fences, etc.).

5. Start the measurement by pressing the **START/STOP** button.

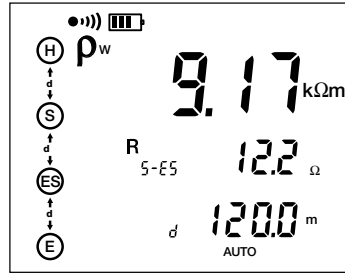

$$\rho_w = 2 \cdot \pi \cdot d \cdot R_{S-ES}$$

To display the measurement parameters, press **DISPLAY** several times.

The device displays the following parameters:

$\rho_w$ ,  $R_{S-ES}$ ,  $d$ ,  $U_{S-ES}$ ,  $I_{H-E}$ , U-Act ( $U_{S-ES}$  and its frequency,  $U_{H-E}$  and its frequency).

To measure the resistances of the auxiliary electrodes **H (Z)**, **S (Y)**, **ES (Xv)** and **E (X)**, or if the resistance of the electrodes is too high (see § 10.1), start the measurement by a long press of the **START/STOP** button.

$R_{P-E}$  and  $R_{P-H}$ , then  $R_{P-ES}$  and  $R_{P-S}$  will be displayed.

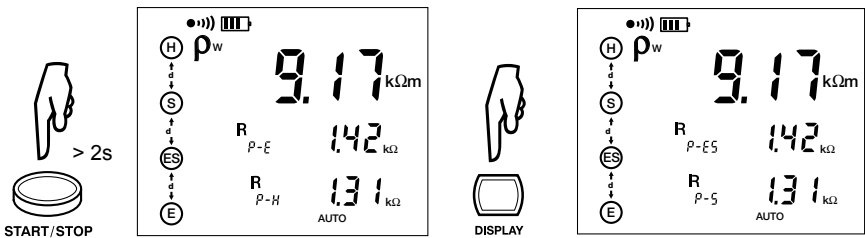

### 5.6.5 Schlumberger Method

1. Set the switch to  $\rho$ .
2. Place electrodes **S (Y)** and **ES (Xv)** at a distance **A** apart, then place electrodes **H (Z)** and **E (X)** in the same straight line, at a distance **d** measured from the midpoint of distance **A**. Distance **d** must be between 2 and 30m.
3. Drive the electrodes to a depth **p** of not more than 1/3 of **d**.
4. Connect the cables to the electrodes, then to terminals **H (Z)**, **S (Y)**, **ES (Xv)**, and **E (X)**.
5. Program the distance into the instrument as described in § 5.6.3.

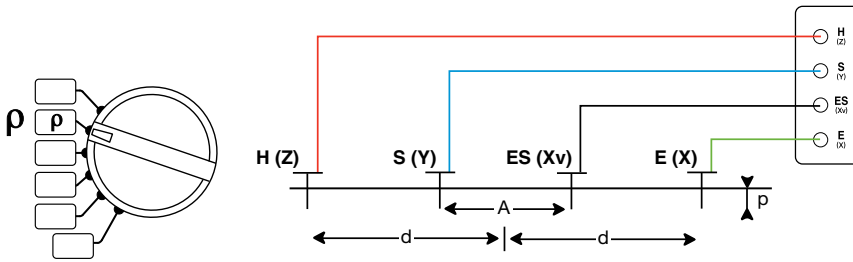

In order to avoid electromagnetic interference, it is best to unwind the full length of each cable from the reel, to keep the cables as far apart as possible on the ground, taking care not to form loops, and to avoid placing the cables near or parallel to metallic conductors (cables, rails, fences, etc.).

6. Start the measurement by pressing the **START/STOP** button.

$$\rho_s = 2 \cdot \pi \cdot \frac{d^2 - A^2}{4} \cdot R_{S-ES}$$

To display the measurement parameters, press **DISPLAY** several times.

The device displays the following parameters:

$\rho_s$ ,  $R_{S-ES}$ ,  $d$ ,  $U_{S-ES}$ ,  $I_{H-E}$ ,  $U_{Act}$  ( $U_{S-ES}$  and its frequency,  $U_{H-E}$  and its frequency).

To measure the resistances of the auxiliary electrodes **H (Z)**, **S (Y)**, **ES (Xv)**, and **E (X)**, or if the resistance of the electrodes is too high (see § 10.1), start the measurement by a long press of the **START/STOP** button.

$R_{P-E}$  and  $R_{P-H}$ , then  $R_{P-ES}$  and  $R_{P-S}$  will be displayed.

## **MANUAL MODE**

All of the measurement functions described in § 5 (**AUTO mode**) can be performed in **MANUAL** mode if necessary.

To access **MANUAL** mode:

- Press the **Hz/OPTIONS** button once. The **Hz/OPTIONS** symbol appears and the **AUTO** indicator blinks.
- Use the ► button to switch from **AUTO** to **MANUAL**.
- When the tester is in **MANUAL** mode you can press **Hz/OPTIONS** repeatedly to see various parameters that can be set, depending on the measurement function selected.

When a measurement is performed by a short or long press on the **START/STOP** button (the circular arrows  on the display will rotate), the measurement can be stopped by a second press of this button.

Whenever a new measurement function is selected, the device automatically changes back to **AUTO** mode.

### **6.1 Switching the Test Voltage**

Available in all functions except  $m\Omega$ .

If necessary, the test voltages can be switched to either 16 or 32V as follows:

- Press the **Hz/OPTIONS** button, then press it again to make the output voltage ( $U_{out}$ ) blink.
- Use the ► button to switch to 16 or 32V, then press **Hz/OPTIONS** again.

This setting is retained when the unit is turned off.

## 6.2 Measurement Frequency Selection

If there are signals with a frequency that could interfere with the chosen test frequency, the **NOISE** symbol will appear.

While in **MANUAL** mode, change the frequency by pressing the **Hz/OPTIONS** button until the frequency flashes.

Press the ► button to choose the following frequencies:

- USr, 55, 92, 110, 119, 128 Hz (128 Hz is default).
- 128, 1367, 1611, 1758 Hz for the 2-clamps function (1611 Hz is default).

To change the user frequency (USr), press the ▲ ▼ buttons (▲ ▼ raises the value, and 2<sup>nd</sup> + ▲ ▼ lowers it).

Table of possible USr frequencies (48 values from 41 to 513Hz):

41	43	46	49	50	55	60	61	64	67	69	73	79	82	85	92
98	101	110	119	122	128	134	137	146	159	165	171	183	195	201	220
238	244	256	269	275	293	317	330	342	366	391	403	439	476	488	513

There are two user frequencies: one for resistivity and one for earth and soil potential measurements. These two values remain in memory even after the device is switched off.

For soil resistivity measurements, the user frequency is limited to 128Hz.

## 6.3 Manual Settings for mΩ Measurements

Pressing **Hz/OPTIONS** in **MANUAL** mode allows the following parameters to be changed using the ► button:

- Terminal symbols **H** and **E** blink → **H S ES E** blink (4-Pole measurement)
- POS on **H** and DC+ blinks → neg on **H** and DC- (reversal of polarity at terminal **H**)

In **MANUAL** mode the tester does not reverse polarity automatically during the measurement; however, the polarity can be reversed during the measurement by pressing the **Hz/OPTIONS** button.

### 6.3.1 Continuity Test

The 2-wire  $m\Omega$  measurement gives a quick measurement result, accompanied by an audible beep, during a continuity check.

The display is in the sensitivity range ( $0.5\Omega$  to  $1.99k\Omega$ ) and the terminal check is limited to terminal **H (Z)** (a cable must be connected to it), making it possible to start the measurement with an open circuit.

For a continuity check, the following settings are mandatory:

- The 2-wire  $m\Omega$  measurement function must be selected.
- The device must be in manual mode.
- The alarm function must be active (On).
- The alarm threshold must be low (<).
- The buzzer must be activated (bEEP On).

## 6.4 3-Pole Earth/Ground Measurements & Coupling

### 6.4.1 3-Pole Earth/Ground Measurements

Pressing on **Hz/OPTIONS** in **MANUAL** mode allows the following parameters to be changed using the ► button:

- EARTH blinks → Earth Coupling Measurement
- 128 Hz blinks → Test Frequency Measurement
- Test voltage blinks → Test Voltage Selection

### 6.4.2 Earth/Ground Coupling Measurements

This measurement calls for making and storing three intermediate measurements (at the same frequency). It is available only in **MANUAL** mode.

Connection diagram:

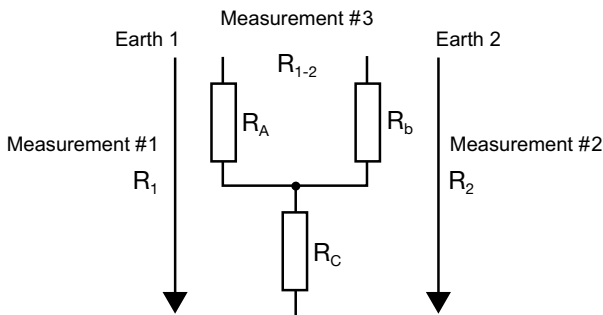

Press **Hz/OPTIONS** and use the ► button to switch from **EARTH** to **EARTH COUPLING**. Proceed as follows:

- If you want to eliminate the resistance of the measurement leads, you can use lead compensation (**2nd + START**) before starting the actual coupling measurement (see § 5.2.1).
- Turn the rotary switch to 3-Pole.
- Select a test frequency and a test voltage (if desired).
- The screen displays **EARTH COUPLING 1**. Make a 3-pole earth measurement on the first earth system (measurement of  $R_1$  in the connection diagram on previous page).
- Stop the measurement by pressing the **START/STOP** button. The **MEM** symbol flashes to indicate that this result must be recorded in memory. Press the **MEM** button twice. To save to another location, refer to §7.
- The screen now displays **EARTH COUPLING 2**. Make a 3-pole earth measurement on the second earth system (measurement of  $R_2$ ). For this second measurement, leave the **H (Z)** and **S (Y)** electrodes in the same positions as for the first measurement.
- Store this result in the same memory location as before by pressing the **MEM** button twice.
- The screen now displays the message **EARTH COUPLING 3**. Disconnect terminal **S (Y)** and make a 2-wire resistance measurement with terminal **H (Z)** connected to earth 1 and terminal **E (X)** to earth 2.
- Record this result by pressing the **MEM** button twice.
- **EARTH COUPLING 4** and the results of the measurements are displayed.

The calculation is based on the following formulas:

$$R_c = (R_1 + R_2 - R_{1-2})/2$$

$$C_1 = R_c/R_1 \text{ and } C_2 = R_c/R_2 \quad R_A = R_1 - R_c$$

$$R_b = R_2 - R_c$$

- To display all of the measurement parameters, press the **MR** button.
- To scroll through all of the measurements, use the ► and ▲ buttons.

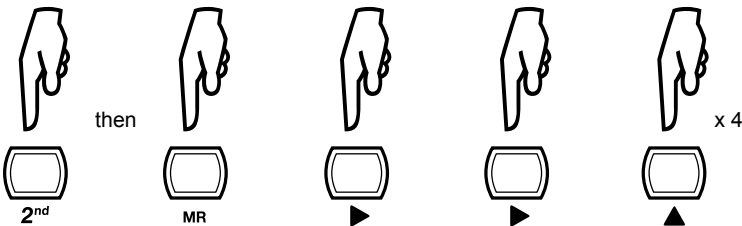

Press **DISPLAY** several times to display the following parameters:

<b>EARTH COUPLING 1</b>	$R_1$ , $U_{OUT}$ and frequency, $U_{S-E}$ , $I_{H-E}$ , U-In ( $U_{S-E}$ and frequency) $R_H$ and $R_S$ if long press of START/STOP
<b>EARTH COUPLING 2</b>	$R_2$ , $U_{OUT}$ and frequency, $U_{S-E}$ , $I_{H-E}$ , U-In ( $U_{S-E}$ and frequency) $R_H$ and $R_S$ if long press of START/STOP
<b>EARTH COUPLING 3</b>	$R_{1-2}$ , $U_{H-E}$ and frequency, $I_{H-E}$ , U-In ( $U_{H-E}$ and frequency).
<b>EARTH COUPLING 4</b>	$R_C$ , $C_1$ , $C_2$ , $R_A$ , $R_b$ , $U_{out}$ and its frequency.

## 6.5 4-Pole Earth/Ground Measurements

Pressing the **Hz/OPTIONS** button allows the following parameters to be changed using the ► button:

- 128Hz blinks → Change the test frequency
- Test voltage blinks → Switch between 16 and 32V

## 6.6 Soil Resistivity Measurements

Pressing the **Hz/OPTIONS** button allows the following parameters to be changed using the ► button:

- $\rho_W$  blinks (Wenner method) → Switch to  $\rho_S$  (Schlumberger method)
- 128Hz blinks → Change the test frequency
- Test voltage blinks → Switch between 16 and 32V

## 6.7 Smoothing

In the manual mode, you can activate or deactivate the smoothing of the measurement results by pressing the **2nd + DISPLAY (SMOOTH)** buttons. This smoothing displays an exponential mean value, a significant help with highly fluctuating values.

# MEMORY FUNCTION

The device has a total of 512 memory locations. Each of these locations is defined by an object number (OBJ) from 01 to 99 and by a TEST number from 01 to 99.

During soil potential or resistivity measurements (Wenner or Schlumberger methods), several measurement results are recorded at the same memory location, with the distance between electrodes as the third addressing criterion.

For earth coupling measurements (EARTH COUPLING 1, 2, 3, 4), the four measurements provide the third addressing criterion for the same memory location.

None of the other measurements has an additional addressing criterion, so each occupies only one memory address.

Since each measurement is dated, you must set the date and time of the device before any storage in memory (see § 4.2).

## 7.1 Saving Measurements into Memory

Measurement results can be saved by performing the following:

- Press the **MEM** button. The tester will automatically suggest the next free memory location (FrEE message).
- Press the **MEM** button a second time to save to the OBJ/TEST location.
- If you decide not to save your results, press **DISPLAY** to exit MEM mode.
- To change the OBJ and TEST location, use the ► and ▲▼ buttons.

**NOTE:** If a memory location is already occupied, the message  will be displayed. Pressing the **MEM** button will overwrite the measurement record.

For soil resistivity and potential measurements, if several measurements are made with different distances (**d**), you can store them under the same OBJ:TEST number, with the distance being the third criterion.

It will be possible to overwrite values already stored with new ones having the same distance **d**, or even to add new results having other values for the distance **d** provided that all of the other measurement parameters are identical.

## 7.2 Recalling Measurements from Memory

To recall saved measurements, perform the following:

- Select a measurement function, then press the **2<sup>nd</sup>** and **MR** buttons.
- Use the **▶** and **▲ ▼** buttons to choose the OBJ and TEST numbers.
- Press the **DISPLAY** button to display the time (tiME) and date (dAtE).
- Press **DISPLAY** again to display the measurement and its parameters.
- Press the **MR** button again to exit the recall mode.

The SET-UP function lets you read all memory addresses one after the other independently of which measurement function is chosen.

Any measurement stored in the tester can be retrieved individually using Data-View® software (see § 8).

## 7.3 Erasing Measurements from Memory

There are two ways to erase measurements - complete and selective.

### 7.3.1 Erasing All Measurements

- Set the switch to SET-UP.
- Push once on the **MEM** button to display the number of free and available records.
- Push a second time on the **MEM** button.
- The display will show “**dEL ALL**”. Change the blinking **NO** to **YES** with the **▲** button, then perform a long press (>2s) on the **MEM** button.



**WARNING:** This will delete ALL saved records.

---

- To exit without erasing, perform a short press on the **MEM** button.

### 7.3.2 Erasing Selective Measurements

- Set the switch to SET-UP.
- Hold down the **2<sup>nd</sup>** button, then press the **MR** button.
- Select the desired measurement using the **▶** and **▲ ▼** buttons.
- The display will show “**dEL**”. Change the blinking **NO** to **YES** with the **▲** button, then perform a long press (>2s) on the **MEM** button.
- To exit without erasing, perform a short press on the **MEM** button.

# DATAVIEW® SOFTWARE

## 8.1 Installing DataView®



**DO NOT CONNECT THE INSTRUMENT TO THE PC BEFORE INSTALLING THE SOFTWARE AND DRIVERS.**

---

### Minimum Computer Requirements:

- Windows XP / Windows Vista & Windows 7/8 (32/64 bit)
- 256MB of RAM for Windows XP  
1GB of RAM for Windows Vista & Windows 7/8 (32 bit)  
2GB or RAM for Windows Vista & Windows 7/8 (64 bit)
- 80MB of hard disk space (200MB recommended)
- USB port

*Windows is a registered trademark of Microsoft Corporation in the United States and other countries.*

**NOTE:** When installing, the user must have Administrative access rights during the installation. The users access rights can be changed after the installation is complete.

DataView® must be reinstalled for each user in a multi-user system.

### USB Flash Drive Install

1. Insert the USB stick into an available USB port (wait for driver to be installed).
2. If Autorun is enabled then an AutoPlay window should appear as shown.





**NOTE:** If Autorun is disabled, it will be necessary to open Windows Explorer, then locate and open the USB stick drive labeled “DataView” to view the files on the drive.

3. In the AutoPlay window, select **Open Folder to view Files**.
4. Double-click on **Setup.exe** from the opened folder view to launch the Data-View setup program.



**NOTE:** If installing onto a Vista based computer the **User Account Control** dialog box will be displayed. Select the **Allow** option to proceed.

5. A **Set-up** window, similar to the one below, will appear.

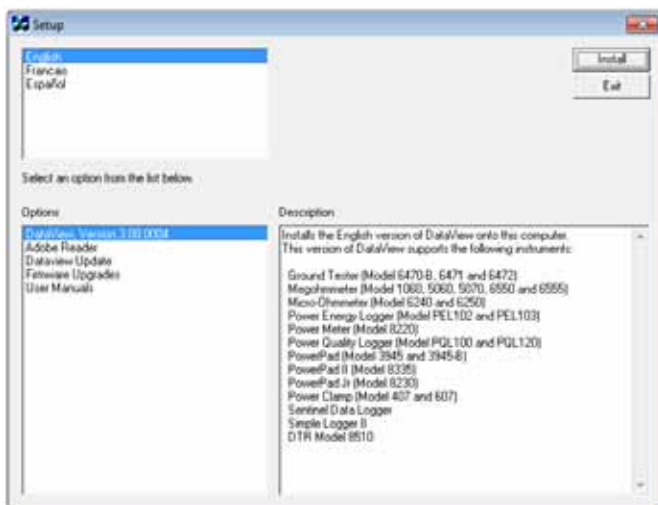

Figure 8-1

There are several different options to choose from. Some options(\*) require an internet connection.

- **DataView, Version x.xx.xxxx** - Installs DataView® onto the PC.
- **\*Adobe Reader** - Links to the Adobe® website to download the most recent version of Adobe® Reader to the computer. *Adobe® Reader is required for viewing PDF documents supplied with DataView®.*
- **\*DataView Updates** - Links to the online DataView® software updates to check for new software version releases.
- **\*Firmware Upgrades** - Links to the online firmware updates to check for new firmware version releases.

- **Documents** - Shows a list of instrument related documents that you can view. Adobe® Reader is required for viewing PDF documents supplied with DataView®.
6. **DataView, Version x.xx.xxxx** option should be selected by default. Select the desired language and then click on **Install**.
  7. The **Installation Wizard** window will appear. Click **Next**.
  8. To proceed, accept the terms of the license agreement and click **Next**.
  9. In the **Customer Information** window, enter a Name and Company, then click **Next**.
  10. In the **Setup Type** window that appears, select the “**Complete**” radio button option, then click **Next**.
  11. In the **Select Features** window that appears, select the instrument’s control panel that you want to install, then click **Next**.



**NOTE:** The **PDF-XChange** option must be selected to be able to generate PDF reports from within DataView®.

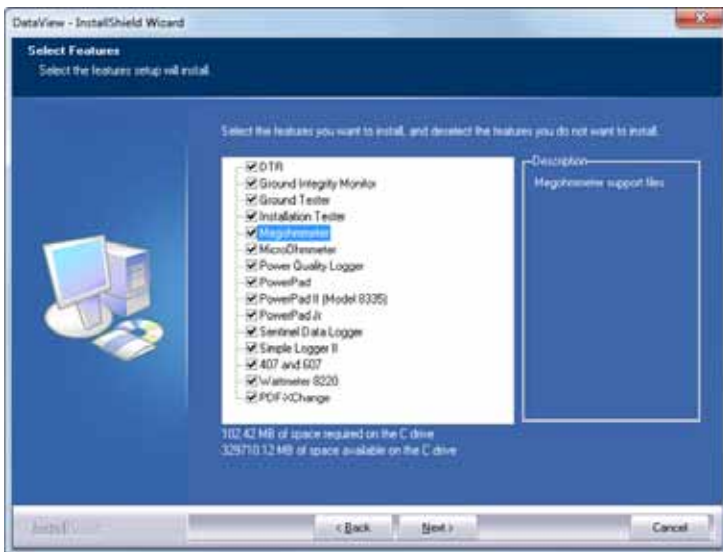

Figure 8-2

12. In the **Ready to Install the Program** window, click on **Install**.
13. If the instrument selected for installation requires the use of a USB port, a warning box will appear, similar to Figure 8-3. Click **OK**.

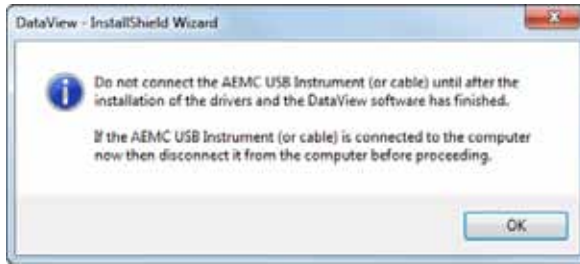

Figure 8-3



**NOTE:** The installation of the drivers may take a few moments. Windows may even indicate that it is not responding, however it is running. Please wait for it to finish.

---

14. When the drivers are finished installing, the **Installation Successful** dialog box will appear. Click on **OK**.
  15. Next, the **Installation Wizard Complete** window will appear. Click on **Finish**.
  16. A **Question** dialog box appears next. Click **Yes** to read the procedure for connecting the instrument to the USB port on the computer.
- 



**NOTE:** The Set-up window remains open. You may now select another option to download (e.g. Adobe® Reader), or close the window.

---

17. **Restart** your computer, then connect the instrument to the USB port on the computer.
18. Once connected, the **Found New Hardware** dialog box will appear. Windows will complete the driver installation process automatically.

Shortcuts for DataView® and each instrument control panel selected during the installation process have been added to your desktop.

---



**NOTE:** If you connected your instrument to the computer before installing the software and drivers, you may need to use the **Add/Remove Hardware** utility to remove the instrument driver before repeating the process.

---

## 8.2 Connecting the Model 6470-B to your Computer

The Model 6470-B is supplied with an optically isolated USB interface cable required for connecting the instrument to the computer. This cable (Cat. #2135.41) is equipped with a USB type A on one end, and an optical connector on the other end.

To connect the Model 6470-B to your computer:

1. Connect the optical connector end of the cable to the serial port on the front panel of the Model 6470-B (see Figure 2-1, Item #4).
2. Connect the USB type A end of the cable, to an available USB port on your computer.

## 8.3 Establishing Communication to the Instrument

- Double-click the **Ground Tester Icon** that was created during software installation, located on the desktop.
- The Connection dialog box will appear. Make sure that the communication port matches the port that the serial cable is plugged into.

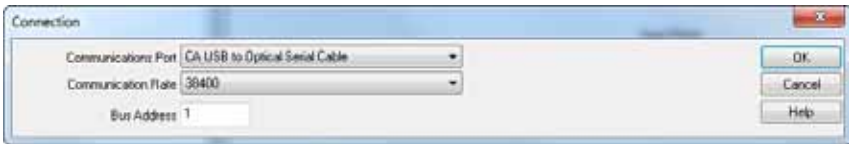

Figure 8-4

- Once the proper communication parameters have been specified, click **OK**.

If the instrument is turned ON at the time the Control Panel is opened, a communication link will happen automatically.

If the instrument is turned OFF at the time the Control Panel is opened, establish a communication link by going to **Instrument > Connect** in the main menu.



The connection status can be seen in the lower right-hand corner of the Control Panel and in the Instrument window under status.

---

## 8.4 The Ground Tester Control Panel

After communication to the instrument is established (see § 8.4), the **Ground Tester Control Panel** will appear.

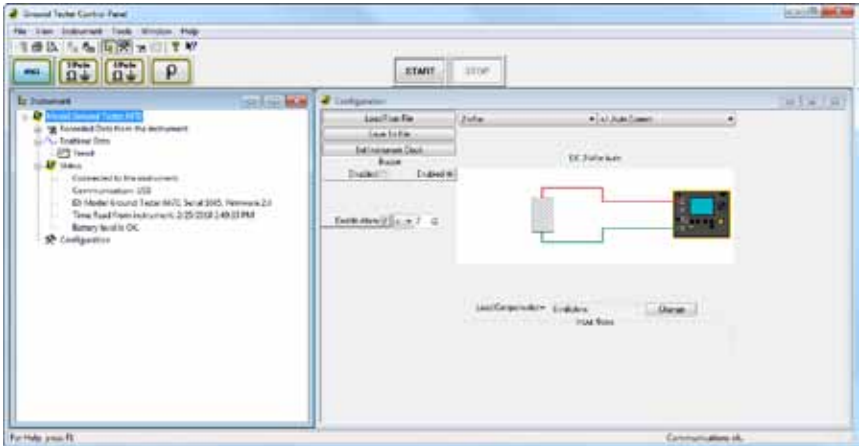

Figure 8-5

The Control Panel consists of the following:

- A shortcut toolbar.
- A toolbar with the mode selection and start/stop buttons.
- The instrument's status window (on the left-hand side):
  - Recorded data from the instrument
  - Real-time data
  - Connection status
  - The communications port and speed of the connection
  - The model number, serial number, and firmware version
  - Date and time from the clock
  - Battery status
- A configuration window that shows all of the parameters available for modification. This window defaults to the instrument mode that is selected.
- Real-time Measurement window that shows the measurement of each test performed in real-time (available only after a test has been performed).

If the indicated items are not shown on the screen, select **Restore Default Layout** from the Window menu.

## 8.5 Configuring the Instrument

First, establish a connection to open the Control Panel (see § 8.4). Located on the right-hand side of the Control Panel is the Configuration window.

Choose a mode to configure:



Common buttons and features in all 4 modes are:

- **Load from File:** Retrieves stored configurations to be used in programming the instrument.
- **Save to File:** Saves the current configuration. This file will reside on the computer's disk drive. Saving different configuration setups can be useful for future functions and tests.
- **Set Instrument Clock:** Updates the clock to the PC clock.
- **Buzzer:** When selected, buzzer is ON.
- **Alarm:** When selected, alarm is ON.
- **Drop-down Indicators:** Indicates the configuration available for each measurement range.



To set the Terminal Label markings (e.g. E, ES, S, H or X, Sv, Y, Z), Numeric format, Measurement units and Rho units, go to **Tools > Options**.

---

## 8.5.1 DC Continuity Test

mΩ

When **DC Continuity** is selected from the tool bar, you can:

- Select a 2- or 4-Wire test.
- Select a test current (positive, negative or Auto ±).
- Enter and activate an alarm from 1 to 999Ω (2-Wire only), if desired.

For very low resistance measurement, a lead compensation value (see § 5.2.1) may be entered using the Change button.

Input noise status at the input of the meter is always displayed.

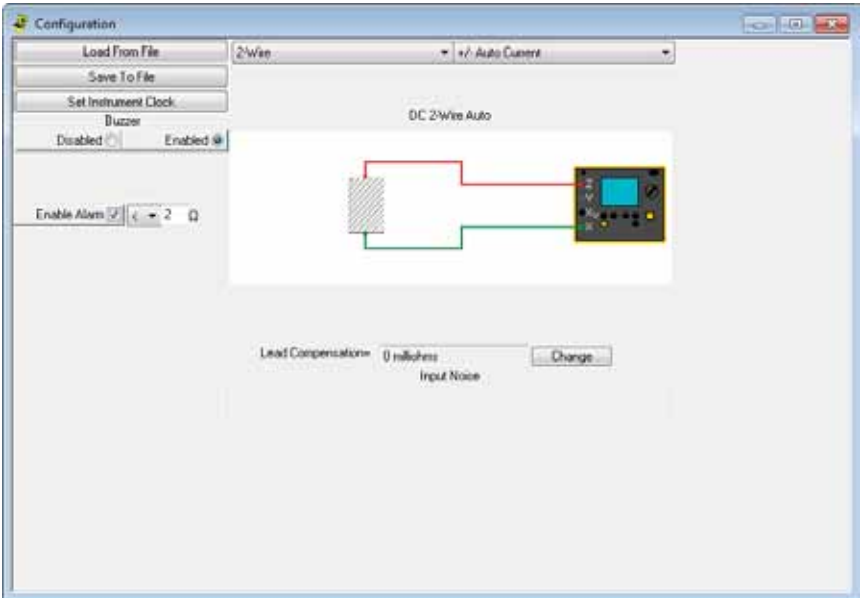

Figure 8-6

## 8.5.2 3-Pole Ground Resistance Test



When **3-Pole Ground Resistance** is selected from the tool bar, you can select:

- With or without Auxiliary Rod Resistance.
- Test voltage of 16 or 32VAC.
- Distance "d" from terminal X to terminal Y.
- Distance "a" from terminal X to terminal Z.
- Auto frequency - selects the optimum frequency (from 41 to 513Hz), usually 128Hz, or select manually from the drop-down frequency list.

Selecting a sweep frequency test from the drop-down list will enable the sweep table selection.

The Input Noise option allows the viewing of noise for Z or Y inputs.

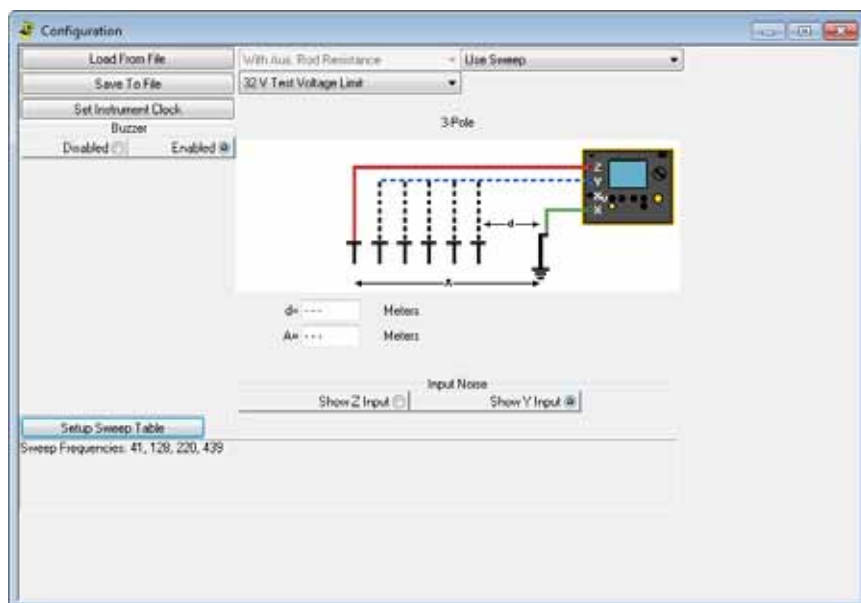

Figure 8-7

### 8.5.3 4-Pole Ground Resistance



When **4-Pole Test Resistivity** is selected from the tool bar, you can select:

- With or without Auxiliary Rod Resistance.
- Test voltage 16 or 32VAC.
- Auto frequency - selects the optimum frequency (from 41 to 513Hz), usually 128Hz, or select manually from the drop-down frequency list.

Selecting a sweep frequency test from the drop-down list will enable the sweep table selection.

The Input Noise option allows the viewing of noise for Z or Y inputs.

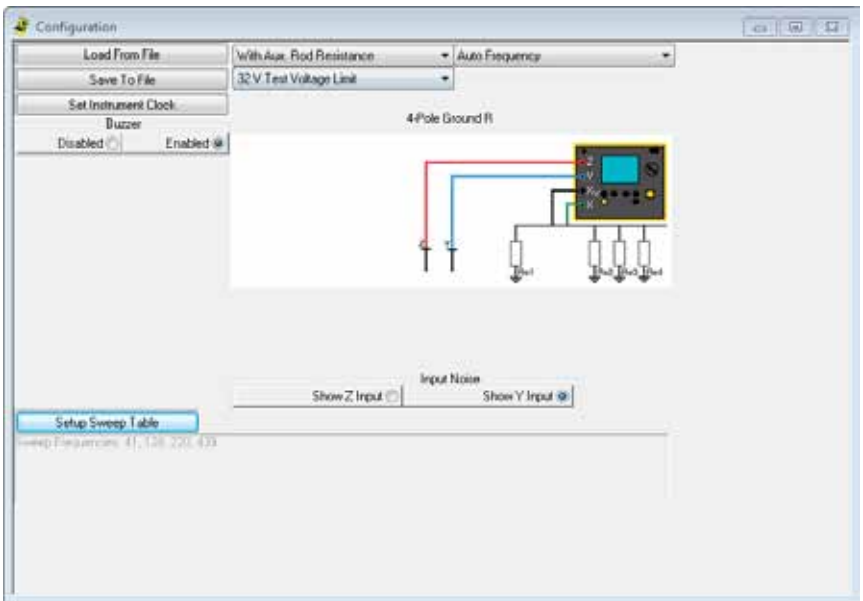

Figure 8-8

## 8.5.4 4-Pole Soil Resistivity $\rho$

When **4-Pole Test Resistivity** is selected from the tool bar, you can select:

- With or without Auxiliary Rod Resistance.
- Test voltage 16 or 32VAC.
- Auto frequency - selects the optimum frequency (from 41 to 128Hz), usually 128Hz, or select manually from the drop-down frequency list.
- Test Method - Wenner or Schlumberger.
- Distances - the distance “d” (for Wenner test method) or “d” and “a” (for Schlumberger test method), needs to be entered for resistivity calculation to read out directly in Rho.

Selecting a sweep frequency test from the drop-down list will bring you to the sweep table selection.

The Input Noise option allows the viewing of noise for Z or Y inputs.

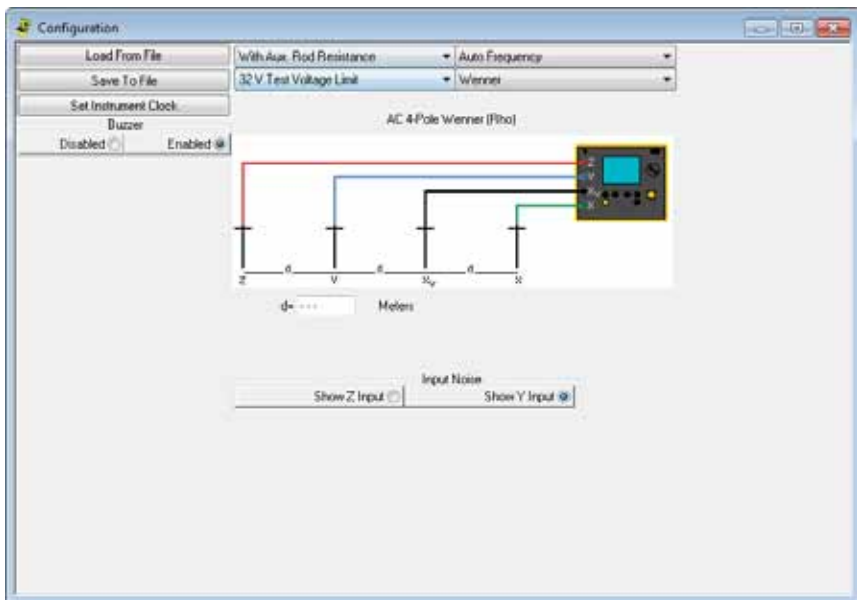

Figure 8-9

## 8.6 Tools Menu

### 8.6.1 Tools > Options

- Set number display as scientific (1000 as "1E+3") or letters (1000 as "1k").
- Set Label Terminals to be "X", "Xv", "Y", "Z", or "E", "ES", "S", H".
- Set Measurement units to meter or feet.
- Set Rho units to Ohm-meter or Ohm-centimeter.

### 8.6.2 Tools > Colors

Sets colors for measurement channels.

### 8.6.3 Tools > Recover Data

Every time the directory of recorded data is displayed by the Ground Tester Control Panel, a backup copy of all the data is saved to a file. Use this option to recover previous data.

## 8.7 Starting a Test

Press the **START** button to begin a test. Some tests configurations are automatic and end when the data is stable. Others, generally when there is a manual frequency, show a **STOP** button, which should be pressed when the data is available on the screen and has stable values.

## 8.8 Downloading Data to Database

Click the plus sign next to **Recorded Data from the instrument** in the Instrument window on the left-hand side.

Select the data you want to download by clicking on the file name. Choose to perform one of the following:

- **Print:** Prints the data.
- **Create DataView Report:** Opens the newly created report in DataView®.
- **Create Spreadsheet.** Allows you to save as either an .xls (Excel spreadsheet file) or .csv (comma delimited file).

## 8.8.1 Session Properties

After creating a DataView® report, you can open the Session Properties dialog box by selecting **Edit > Edit Session Properties**.

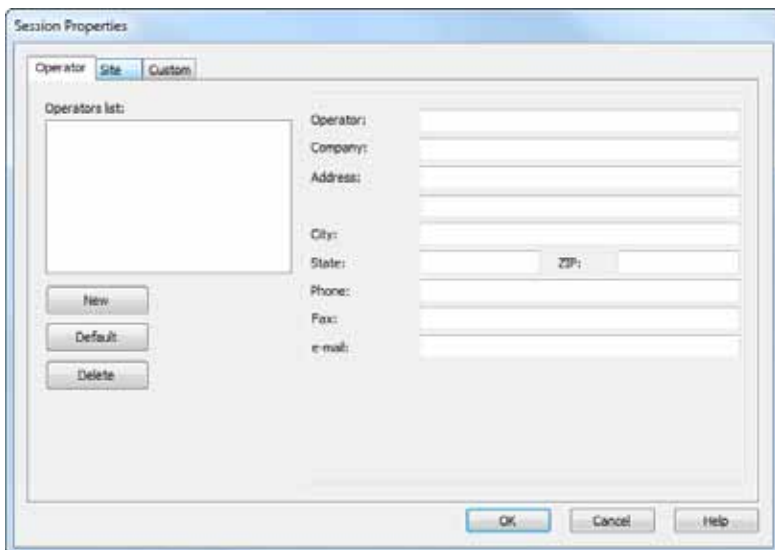

Figure 8-10

The Session Properties dialog box allows you to specify Operator, Site and Custom parameters that are to be saved with recorded data. These parameters are used when generating reports.

The Operator and Site tabs allow you to maintain lists of operators and sites, saving you time when specifying parameters for reports.

On the left of the Operator and Site tabs is the list of previously defined Operators and Sites. On the right of the Operator and Site tabs is the individual parameters that will be saved in an associated database. Only a single set of operator and site fields are saved in the recording database.

The Custom tab allows you to set up user defined parameters. Click the New button to create a user defined parameter. Double-click on the name (or click the Edit button) to assign a name and value. A checkbox appears to the left of the value. Items that are checked will be added to an associated database and used in displaying a report. Only a single set of Custom parameters can be maintained (unlike the Operator and Site lists).



You can also set defaults for session properties within the Ground Tester Control Panel by selecting **File > Edit Session Properties**.

---

## 8.9 Exporting the Report to a PDF File

- Select the data by clicking on the file name under **Recorded Data from the instrument** in the Instrument window on the left-hand side of the Control Panel.
- Click the **Print** button.
- In the Print dialog box that appears, select **PDF-XChange 3.0** from the drop-down menu, then click **OK**.
- When the PDF is complete, the Save As dialog box will appear.
- Choose a location to save the file and click **Save**.

# MAINTENANCE

**Replacement batteries and fuses are available directly online.**  
Check our Storefront at [www.aemc.com/store](http://www.aemc.com/store) for availability.

## 9.1 Maintenance



Please make sure that you have read and fully understand the **WARNING** section on page 3.

- To avoid electrical shock, do not attempt to perform any servicing unless you are qualified to do so.
- To avoid electrical shock and/or damage to the instrument, do not get water or other foreign agents into the case.
- Turn the instrument OFF and disconnect the unit from all circuits before opening the case.
- Use specified spare parts only.

## 9.2 Cleaning



**Disconnect the instrument from any source of electricity.**

Use a soft cloth lightly moistened with soapy water. Wipe with a moist cloth and then dry with a dry cloth. Never use alcohol, solvents or hydrocarbons.

## 9.3 Fuse Replacement

- **Fuse for terminal H (Z):**

If this fuse is defective, the unit will no longer produce an output voltage, making it impossible to perform resistance measurements.

To test this fuse, turn the switch to the  $m\Omega$  position (2-Wire), connect measurement leads to terminals **H (Z)** and **E (X)** and start a measurement. If the unit refuses to operate and the symbol for terminal **H (Z)** blinks, the fuse must be replaced.



Only use the type of fuse shown on label inside the instrument's cover:  
0.63 A 250V 5x20mm 1.5kA (Cat. #2135.81)

---

#### Procedure for replacing fuses:

1. Disconnect the unit completely, turn the rotary switch to OFF, and close the lid.
2. Loosen the four permanent screws at the bottom of the unit, but do not remove them.
3. Open the lid and carefully turn the housing upside-down, making sure the front panel does not fall out. Then carefully pull the front panel and the unit all the way out of the housing.
4. The fuse for terminal **H (Z)** is accessible at the back of the unit (in the corner near the terminal for the battery charger).
5. Wipe off any dirt on the seal and housing rim.
6. Put the unit back into the housing and screw it into place.

## 9.4 Recharging the Battery



To make the best use of the battery and prolong its service life, observe the following rules.

---

- Use only the battery charger supplied with the unit; other chargers may be hazardous!
- Recharge the battery only at temperatures between 32° and 104°F (0° and +40°C).
- Observe the conditions of use and storage defined in the specifications.

Even an NiMH battery can be recharged only a limited number of times. This number, and thus the service life of the battery, is highly dependent on the following factors:

- the operating conditions
- the recharging conditions

As the earth tester might go some time without use and the battery has a natural tendency to run down, you should check the battery level at regular intervals. To do this, turn on the unit and check the battery level indicator  at the top of the display. If there is only one bar in the symbol or if there are no bars at all, the battery should be recharged.

If the unit is not used for a long time, the battery might run down all the way. In this case, recharging can take several hours. In addition, the unit might not work

properly at the start of recharging.

The capacity and lifetime of the battery may also be diminished. After about five charging/discharging cycles the battery will recover its initial capacity.

To recharge the battery, plug the charging unit into the connector at the upper left (connector ② in Fig. 2-1) and connect the charging unit to a 100 to 240VAC power source (suitable for Europe and the U.S.). The frame of the battery symbol will blink during charging. Charging goes faster when the tester is turned off. The battery voltage is shown on the large display next to Ubatt.

At the middle and bottom of the display you will see one of the following messages:

bAtt CHrG	Fast charging is active (normal state)
bAtt LOW	Battery voltage is too low for a fast charge - charging at a lower current
bAtt	Battery voltage is too high for a fast charge - charging at a lower current
bAtt HOt	Battery is too warm for a fast charge (>40°C) - charging at a lower current
bAtt COld	Battery is too cold for a fast charge (<0°C) - charging at a lower current
bAtt FULL	Battery is full - switch to trickle charging

The 6470-B tester can also be recharged from a 12VDC car outlet with a special charging unit.



In this case the low-potential of the vehicle's 12V outlet is at the potential of terminals **E (X)** and **ES (Xv)** of the ground tester. For safety reasons, do not connect or use the unit if there is a possibility that voltages at **E (X)** or **ES (Xv)** could exceed 32V.

---

## 9.5 Replacing the Battery

The battery in this unit is a special product with customized safety features and protective devices. It should be replaced only by the same model. If a different model is used, there is a danger of fire or explosion, leading to possible damage or injury.



**NOTE:** Only replace the battery with an identical model:  
NiMH Custom Pack 9.6V / 3.5 Ah (Cat. #2960.21)

---

### Procedure for replacing the battery:

1. Disconnect the unit completely, turn the rotary switch to OFF, and close the lid.
2. Loosen the four permanent screws at the bottom of the unit, but do not remove them.

3. Open the lid and carefully turn the housing upside-down, making sure the front panel does not fall out. Then carefully pull the front panel and the unit all the way out of the housing.
4. Loosen the two screws on the lid of the battery case and remove the lid.
5. Pull the battery a short way out of the case without overstretching the connection leads, and loosen the two screws at the bottom of the case. Then put the battery back into the case.
6. Making sure the battery leads are not overstretched and that the battery does not fall out, carefully lift off the back of the unit, turn it over and place it next to the front panel with the electronic components.
7. Press the clip off the plug, and pull out the plug with the four battery leads (in the corner, near the terminal for the optical interface). Avoid touching the circuitry or components.
8. Remove the old battery from the case and put in a new one. Run the leads with the plug through the largest slot in the battery case.
9. Insert the battery plug (in the corner, near the terminal for the optical interface). The two pins should point towards the clip. Avoid touching the circuitry or components.
10. Return the back of the unit (with the new battery in the case) to the front panel with the components, taking care not to stretch the battery leads. Carefully lower the back of the unit and make sure that it is aligned correctly (the four cylindrical holes on the back must slip over the four mounting pins on the front panel). Also make sure you do not pinch the battery leads or other wires or components.
11. Pull the battery a short way out of the case without overstretching the connection leads, and re-tighten the two screws at the bottom of the case. Then put the battery back into the case.
12. Put the lid back onto the battery case and screw it shut.
13. Wipe off any dirt on the seal and housing rim.
14. Put the unit back into the housing and screw it into place.
15. Fully charge the new battery in the unit before using it.
16. Reset the time and date.



If the instrument is not used for long periods of time (more than 6 months) it is recommended to make several charge-discharge cycles (3 to 5 times). Discharge cycle (15 H) can be made with the instrument in **MANUAL** mode, DC 2-Pole (2-Pole) resistance measurement and a short-circuit between **H (Z)** and **E (X)** plugs.

---

## **TROUBLESHOOTING**

### **10.1 Error Reporting**

#### **10.1.1 Electrode Resistance Too High**

This can happen in a 3- or 4-pole earth measurement, a resistivity measurement, or an earth potential measurement.

This message is displayed when the measurement is triggered by a short press of the **START/STOP** button and the resistances of the auxiliary electrodes are too high.

The measurement must then be started by a long press on the **START/STOP** button. The device then measures the values of the electrodes and compensates for them to display the correct result.

#### **10.1.2 Out of Range**

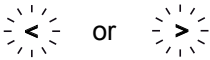

The flashing > or < symbol indicates the measurement is out of range.

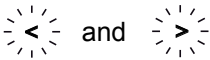

If both symbols flash together, it means that the accuracy of the value displayed is outside of the instrument specification or is subject to large fluctuations. Activating the smoothing function (SMOOTH) may correct this.

Press the **2nd** button, then the **SMOOTH** button to activate smoothing.

#### **10.1.3 Misconnection**



This flashing indicates that a terminal needs to be either connected or disconnected. You must correct the connections or the measurement will not proceed. The flashing of terminal H may also indicate that current  $I_{H-E}$  is too low. The flashing of terminal S may also indicate that resistance  $R_S$  is too high.

To reduce  $R_{H_i}$ , you can add one or more electrodes, 2 meters apart from each other, in the **H (Z)** leg of the circuit, or increase the test voltage.

To reduce  $R_{S_i}$ , you can add one or more electrodes, 2 meters apart from each other, in the **S (Y)** leg of the circuit.

To reduce the resistance of the electrodes, you can also drive them deeper, pack the ground around them well, or dampen them with water.

### 10.1.4 Out of Limits Indicators



This flashing during a **passive** measurement means that the device has detected the presence of an external voltage exceeding 42V on the terminals and that the measurement is impossible.



This flashing during an **active** measurement means that the operating limits have been exceeded.



If this symbol remains lit during an active measurement, it means that the values measured are subject to large fluctuations or that there is an incorrect connection.

**NOISE**

The display of an indefinite value for a passive measurement indicates that measurement current  $I_{ES}$  or  $I_{SEL}$  or voltage  $U_{S-ES}$  is too low.

The display of the NOISE symbol indicates that a stray external voltage is likely to interfere with the measurement. You should change to manual mode and change the measurement voltage and/or frequency in order to make a valid measurement.

After the measurement has started there are indicators of when:

- Values  $R_H$  and/or  $R_S$  are too high,
- Measurement current  $I_{H-E}$ ,  $I_{ES}$  or  $I_{SEL}$  is too low,
- The instability of the measurement is large.

## 10.1.5 Error Messages

When started up, the Model 6470-B device automatically performs a self-test. If a fault appears during this self-test or during a measurement, the device displays a message in the form Err XX.

There are 3 categories of errors:

- **Harmless**      Errors **6, 7, 11**  
The message appears for approximately 1 second to inform the user. Consider a repair if the error recurs.
  - Errors **6** and **7** are always preceded by an automatic reset.
  - During Error **11**, the tester automatically resets to the factory default settings.
  
- **Correctable**      Errors **5, 14, 15, 18, 19, 30, 31, 32** and **33**  
These errors concern the current measurement function and disappear if the function is changed. The device can therefore be used, but a repair will be necessary if the error persists.
  - Error **18** indicates that the rechargeable battery in the tester cannot be recharged. If this error occurs during recharging, disconnect the tester from the charger and follow the procedure described in the “fatal” errors.
  - Error **19** can be corrected by clearing the entire memory of the unit (see section 8.3).
  - Errors **31, 32** and **33** indicate excessive voltage or excessive current during a measurement. Check the measurement setup for faults.
  
- **Fatal**              Errors **0, 1, 2, 3, 8, 12, 13, 15, 16, 18** (during battery recharge) and **21**  
These errors make operation of the unit impossible. Turn off the unit and turn it on again. If the error persists, repair is necessary.

## **GLOSSARY OF TERMS**

### **Basic Terminologies**

Explanations for some of the basic terms related to earth measurements follow:

#### **Auxiliary electrode - H (Z)**

A supplementary electrode through which a measurement current flows.

#### **Earth conductor**

The conductor which connects the installation to be earthed to the earth electrode.

#### **Earth connection**

A locally restricted group of electrically connected earth contacts. It also includes metal parts of installations such as pylon footings, bracings, cable sheathing and earth conductors.

#### **Earth electrode - E (X)**

A conductor which is buried in the earth and makes electrical contact with it.

#### **Earth potential**

The potential difference measured between the earth connection and a reference earth electrode.

#### **Earth electrode - ES (Xv)**

A connection on the earth electrode or earthing system used for measuring the potential of the earth electrode.

#### **Earth resistance**

The resistance measured between the earth connection and a reference earth electrode (cf. selective earth resistance).

#### **Earth**

The location of an earth connection (see also reference earth).

#### **Earthing system**

The set of all installations connected to the earth.

#### **Electrode - S (Y)**

An auxiliary electrode used for measuring the potential of the reference earth. The voltage, which is proportional to the resistance of the earth connection, is measured between this electrode and the earth electrode.

## Reference earth

The area of earth (especially at the surface) which is outside the range of influence of the earth electrode or earthing system.

## Resistivity of the earth ( $\rho$ )

Resistivity is defined as the resistance from wall to opposite wall of a cubic meter of soil. It is measured in ohm-meters ( $\Omega\text{m}$ ).

## Selective earth resistance

The parallel partial resistance of an earth connection or earthing system. It is measured by selective measurements of current in the corresponding resistance branch. A selective earth resistance is always greater than the total earth resistance (parallel connection).

## Step voltage

The potential difference bridged by a person who takes a step of 1m (approx. 3 ft), with the resulting current flowing through the body from one foot to the other (cf. touch voltage).

## Supplementary electrode

An additional earth electrode (earth stake, earth rod).

## Touch voltage

The potential difference which a person is able to bridge with his or her body, the resulting current being limited by the body and the local earth resistance (cf. step voltage).

The general term earth measurement can refer to measurements of individual earth electrodes, earth connections or entire earthing systems, depending on the object of interest.

## Glossary

This glossary lists the terms and abbreviations used on the instrument and the digital display.

- 3-Poles** : measurement of earth resistance with 2 auxiliary stakes (3-Pole method)
- 4-Poles** : 4-Pole measurement of low earth resistance with 2 auxiliary stakes (4-Pole method)
- $C_1$**  : earth coupling coefficient  $R_A$  with earth  $R_b$  ( $C_1 = R_C / R_1$ )
- $C_2$**  : earth coupling coefficient  $R_b$  with earth  $R_A$  ( $C_2 = R_C / R_2$ )
- d, A** : distances to be programmed to calculate resistivity according to the measuring method used
- m $\Omega$**  : measurement of low resistance /continuity
- E** : terminal E (X) - earth socket; current measurement return

	terminal
<b>EARTH</b>	: earth measurement (3 or 4 poles)
<b>EARTH COUPLING</b>	: coupling measurement between two earth sockets
<b>ES</b>	: ES (Xv) terminal (measurement potential socket for calculating earth resistance)
<b>H</b>	: H (Z) terminal (measurement current injection terminal)
<b>I-Act</b> <sup>(1)</sup>	: external current circulating at present between the instrument terminals
<b>I<sub>H-E</sub></b>	: measurement current circulating between the H and E terminals
<b>NOISE</b>	: indicates the presence of external interference causing misrepresentation of the earth or resistivity measurement
<b>R</b>	: average resistance calculated from R+ and R-
<b>R+</b>	: resistance measured with a positive current circulation from terminal H to E
<b>R-</b>	: resistance measured with a negative current circulation from terminal H to E
<b>R-Act</b> <sup>(1)</sup>	: resistance currently calculated from values U-Act and I-Act
<b>R<sub>1</sub></b>	: first value measured to calculate the coupling between 2 earth sockets ( $R_1 = R_A + R_C$ )
<b>R<sub>2</sub></b>	: second value measured to calculate the coupling between 2 earth sockets ( $R_2 = R_b + R_C$ )
<b>R<sub>1-2</sub></b>	: third value measured to calculate the coupling between 2 earth sockets ( $R_{1-2} = R_A + R_b$ )
<b>R<sub>A</sub></b>	: first earth value calculated ( $R_A = R_1 - R_C$ )
<b>R<sub>b</sub></b>	: second earth value calculated ( $R_b = R_2 - R_C$ )
<b>R<sub>C</sub></b>	: coupling resistance between earths R <sub>A</sub> and R <sub>b</sub> ( $R_C = (R_1 + R_2 - R_{1-2}) / 2$ )
<b>R<sub>E</sub></b>	: earth resistance connected to terminal E
<b>R<sub>H</sub></b>	: resistance of the stake connected to terminal H
<b>R<sub>PASS</sub></b>	: value of the R-Act resistance (PASS for "passive" measurement with interference current circulating in the installation)
<b>R<sub>S</sub></b>	: resistance of the stake connected to terminal S
<b>R<sub>S-ES</sub></b> <sup>(2)</sup>	: resistance between stakes S and ES (used for resistivity measurement)
<b>R<sub>Δ0</sub></b>	: measuring lead compensation resistance

<b>S</b>	: S (Y) terminal (reference potential socket for calculating earth resistance)
<b>U-Act</b> <sup>(1)</sup>	: external voltage currently present on the instrument terminals
<b>U</b> <sub>H-E</sub>	: voltage measured between terminals H and E
<b>U</b> <sub>OUT</sub>	: voltage generated by the instrument between terminals H and E (32V or 16V)
<b>U</b> <sub>S-E</sub>	: voltage measured between terminals S and E
<b>U</b> <sub>S-ES</sub>	: voltage measured between terminals S and ES
<b>U</b> <sub>SR</sub>	: frequency chosen by the user
<b>U</b> <sub>SrEL</sub>	: voltage of terminal S (compared with E) expressed as a relative value (rEL); value without unit
$\rho_s$	: ground resistivity measured according to the Schlumberger method (expressed as $\Omega.m$ )
$\rho_w$	: ground resistivity measured according to the Wenner method (expressed as $\Omega.m$ )

- (1) The suffix **Act** becomes **In** (for "Input" in English) when this value is recorded by the instrument and then read, to make a distinction between the current and recorded values. In both cases, this value on the display is associated with its frequency.
- (2) In this case, the resistances of the 4 rods used for measurement are indicated by  $R_{P-H}$ ,  $R_{P-S}$ ,  $R_{P-ES}$ ,  $R_{P-E}$ .

## **Repair and Calibration**

To ensure that your instrument meets factory specifications, we recommend that it be scheduled back to our factory Service Center at one-year intervals for recalibration, or as required by other standards or internal procedures.

### **For instrument repair and calibration:**

You must contact our Service Center for a Customer Service Authorization Number (CSA#). This will ensure that when your instrument arrives, it will be tracked and processed promptly. Please write the CSA# on the outside of the shipping container. If the instrument is returned for calibration, we need to know if you want a standard calibration, or a calibration traceable to N.I.S.T. (Includes calibration certificate plus recorded calibration data).

**Ship To:** Chauvin Arnoux®, Inc. d.b.a. AEMC® Instruments  
15 Faraday Drive  
Dover, NH 03820 USA  
Phone: (800) 945-2362 (Ext. 360)  
(603) 749-6434 (Ext. 360)  
Fax: (603) 742-2346 or (603) 749-6309  
E-mail: [repair@aemc.com](mailto:repair@aemc.com)

(Or contact your authorized distributor)

Costs for repair, standard calibration, and calibration traceable to N.I.S.T. are available.

**NOTE: You must obtain a CSA# before returning any instrument.**

## **Technical and Sales Assistance**

If you are experiencing any technical problems, or require any assistance with the proper operation or application of your instrument, please call, mail, fax or e-mail our technical support team:

Chauvin Arnoux®, Inc. d.b.a. AEMC® Instruments  
200 Foxborough Boulevard  
Foxborough, MA 02035 USA  
Phone: (800) 343-1391  
(508) 698-2115  
Fax: (508) 698-2118  
E-mail: [techsupport@aemc.com](mailto:techsupport@aemc.com)  
[www.aemc.com](http://www.aemc.com)

**NOTE: Do not ship instruments to our Foxborough, MA address.**

## **Limited Warranty**

The Model 6470-B is warranted to the owner for a period of one year from the date of original purchase against defects in manufacture. This limited warranty is given by AEMC® Instruments, not by the distributor from whom it was purchased. This warranty is void if the unit has been tampered with, abused or if the defect is related to service not performed by AEMC® Instruments.

**Full warranty coverage and product registration is available on our website at [www.aemc.com/warranty.html](http://www.aemc.com/warranty.html).**

**Please print the online Warranty Coverage Information for your records.**

### **What AEMC® Instruments will do:**

If a malfunction occurs within the one-year period, you may return the instrument to us for repair, provided we have your warranty registration information on file or a proof of purchase. AEMC® Instruments will, at its option, repair or replace the faulty material.

**REGISTER ONLINE AT:  
[www.aemc.com](http://www.aemc.com)**

## **Warranty Repairs**

### **What you must do to return an Instrument for Warranty Repair:**

First, request a Customer Service Authorization Number (CSA#) by phone or by fax from our Service Department (see address below), then return the instrument along with the signed CSA Form. Please write the CSA# on the outside of the shipping container. Return the instrument, postage or shipment pre-paid to:

**Ship To:** Chauvin Arnoux®, Inc. d.b.a. AEMC® Instruments  
15 Faraday Drive • Dover, NH 03820 USA  
Phone: (800) 945-2362 (Ext. 360)  
(603) 749-6434 (Ext. 360)  
Fax: (603) 742-2346 or (603) 749-6309  
E-mail: [repair@aemc.com](mailto:repair@aemc.com)

**Caution:** To protect yourself against in-transit loss, we recommend you insure your returned material.

**NOTE:** You must obtain a CSA# before returning any instrument.





08/13

99-MAN 100298 v20

**Chauvin Arnoux®, Inc. d.b.a. AEMC® Instruments**

15 Faraday Drive • Dover, NH 03820 USA • Phone: (603) 749-6434 • Fax: (603) 742-2346

[www.aemc.com](http://www.aemc.com)