

---

**Agilent 81130A/'32A  
Performance Test**

## Introduction

Use the tests in this chapter if you want to check that the Agilent 81130A Pulse Generator Frame with the Agilent 81132A 660 MHz Output Channel(s) is working correctly. Before starting any testing allow all test equipment to warm up for at least 30 minutes.

## Conventions Used

When referring to actions that you perform during the tests, the following conventions are used:

FUNCTION This indicates that a labelled button must be pressed

[**MODE/TRG**] This shows that a soft-key must be pressed. A soft-key is an unlabelled button whose label is shown on the display, and which can vary according to the job that the button is doing

**CONTINUOUS PULSES** This is an option shown on the display, and is selected by use of the vernier keys. It is shown in upper or lower case to match the case displayed.

## Test Results Tables

Tables for entering the results of the tests are included at the end of this chapter. The tests are numbered and reference numbers for each Test Result (TR) are given in a small table at the end of each test. The reference number shows you where the actual results should be entered in the Test Results Tables.

The Test Results tables at the end of the chapter should be photocopied, and the Test Results entered on the copies. Then, if the tests need to be repeated, the tables can be copied again.

If Channel 2 has been fitted to your instrument, make an extra copy of the Test Results tables for entry of the results of tests on that channel. In this case, however, it is not necessary to repeat the Period tests, as these are common to both channels.

## Recommended Test Equipment and Accessories

The following tables list the recommended test equipment you need to perform all the tests in this chapter. You can use alternative instruments if they meet the critical specifications given. The test set-ups and procedures assume you are using the recommended equipment.

Test Equipment	Model	Critical Specifications
Oscilloscope or	Agilent 54121T	20 GHz, 10 bit vertical resolution, Histogram
Oscilloscope	Agilent 54750A + Agilent 54751A	20 GHz, 15 bit vertical resolution, Histogram
Counter or	Agilent 53132A #001/010, 030	Frequency measurements > 150 MHz High-Stability Timebase, 3 GHz Channel
Counter	Agilent 5334B #010, 030	Period and Time Interval measurements Oven Osci, 1.3 GHz C-Channel
Digital Voltmeter	Agilent 3458A	DCV up to 20 V
Delay line	Agilent 54008A	22 ns

Accessories	Model	Critical Specifications
Digitizing Oscilloscopes Accessories		
Attenuators	33340C#020 33340C#006	20 dB 6 dB
Power Splitter	11667B	
SMA/SMA (m-m) adaptor	1250-1159	
SMA (f)/BNC (m) Adaptor	1250-1700	
SMA (m)/BNC (f) Adaptor	1250-1200	
SMA Cable	8120-4948	

Accessories	Model	Critical Specifications
50 $\Omega$ Feedthrough Termination	10100C <b>See Figure</b>	2 W,1% 10 W,0.1%
Adaptor	1251-2277	BNC to Banana
Cable Assemblies, BNC	8120-1839	
Torque Wrench	8710-1582	5/16 in, 5 lb-in (56 Ncm)

---

**NOTE:**

When you connect the test equipment for the first time, and whenever you change the setup during the course of these tests, use the 8710 - 1582 torque wrench to tighten and loosen SMA connectors. This will ensure that the connectors are at the correct tightness and give the best signal transfer.

---

### 50 Ohm, 0.1%, 10 W Feedthrough Termination

The following figure provides a schematic and a parts list except for the case. The case must provide shielding and maintain grounding integrity.

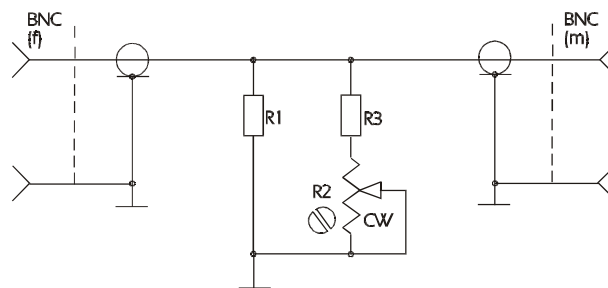

### 50 Ohm, 0.1%, 10 W Feedthrough Termination

The following parts are required:

1. R1 = 53.6 $\Omega$ , 1%, 10 W; Part Number: 0699-0146.
2. R2 = 200  $\Omega$ , 10%, 0.5 W, Variable trimmer; Part Number: 2100-3350.
3. R3 = 681  $\Omega$ ;, 1%, 0.5 W; Part Number: 0757-0816.
4. BNC (M): Part Number: 1250-0045.
5. BNC (F): Part Number: 1250-0083.

## Getting Started

The Agilent 81130A is controlled by selecting options in a series of **pages** that are displayed on the instrument's screen. These options vary with the boards that are fitted in the instrument. When the Agilent 81130A is being tested, therefore, different situations can arise, depending on whether you have a standard instrument or one that has had additional boards fitted. The following examples illustrate this

### Typical Examples of Displayed Screens

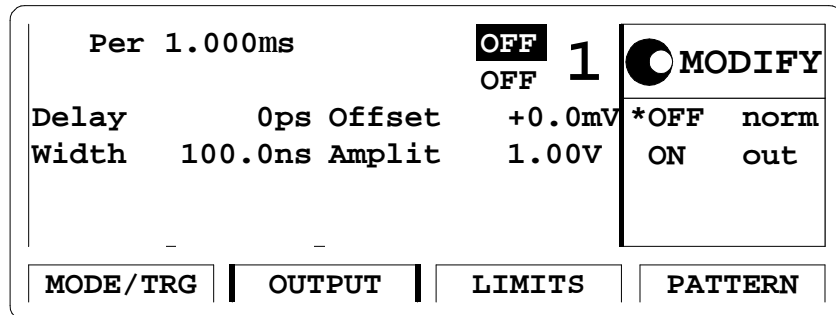

The OUTPUT Screen in a Standard Agilent 81130A

<b>1</b>	OFF	<b>Per</b> 1.000ms	OFF	<b>2</b>	<input checked="" type="radio"/> <b>MODIFY</b>
	OFF		OFF		
Delay		0ps	Delay	0ps	*Period
Width	100.0ns	Width	100.0ns		Frequency
MODE/TRG		TIMING		LEVELS	
				PATTERN	

The TIMING Screen in an Agilent 81130A with qty 2 of Agilent 81132A

<b>1</b>	ON		ON	<b>2</b>	<input checked="" type="radio"/> <b>MODIFY</b>
	OFF		OFF		
Seperate Outputs					
<b>High</b>	+500mV	Offset	+0.0mV		*High-Low
<b>Low</b>	-500mV	Amplit	1.00V		Offs-Ampl
					Set ECL
MODE/TRG		TIMING		LEVELS	
				PATTERN	

The LEVELS Screen in an Agilent 81130A with qty 2 of Agilent 81132A

## Instrument Serial Numbers

You will need to write the serial numbers of the instrument at the top of the Test Reports. These can be found as follows:

Press HELP, [SERIAL #]

The Agilent 81130A display lists the instrument's products and serial number.

The display on your instrument should look similar to this:

**FRAME** : **81130A** **660 MHz**  
**Serial No** : **DE38B00132**

### OUTPUTS

**Ch1-Bd.** : **81132A**  
**Ch2-Bd.** : **81132A**

The serial number given for the **FRAME** applies to the Mainframe, the Power Supply, the Microprocessor Board, and the Timing Board. The number(s) available of the Output Channel(s) applies to the installed numbers of outputs and Model Number.

## Initial Setup of the Agilent 81130A

In the majority of these tests the initial setting up of the instrument is identical. Therefore, it is described once here, and then referred-to where appropriate. In cases where the initial setup differs, an illustration of the settings is shown.

Set up the Agilent 81130A as follows:

1. Select [MODE/TRG]
  - CONTINUOUS PULSES
2. Select [OUTPUT 2], if second channel is installed
  - Separate Out 2
3. Select MORE [CONFIG] screen and set up as follows.  
If a second output channel is installed select grouped by OUTPUT 1 / 2

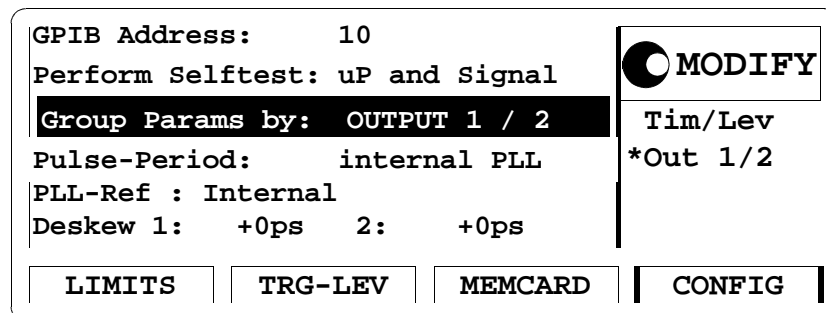

CONFIG Screen, Parameters grouped by OUTPUT

---

***NOTE:***

---

Set-ups are given in all the tests for [OUTPUT 1] and [OUTPUT 2].  
If you are testing a single channel instrument set up the  
[OUTPUT] screen with the settings given for [OUTPUT 1].

## Test 1: Frequency

### Test Specifications

Range 1 kHz to 660 MHz  
Resolution 4 digits, best case 2 ps  
Accuracy  $\pm 0.01\%$

### Equipment Needed

Counter Agilent 53132A  
Cable, 50  $\Omega$ , coaxial, BNC; SMA/BNC Adaptor

### Procedure

Connect the Agilent 81130A to the counter as follows:

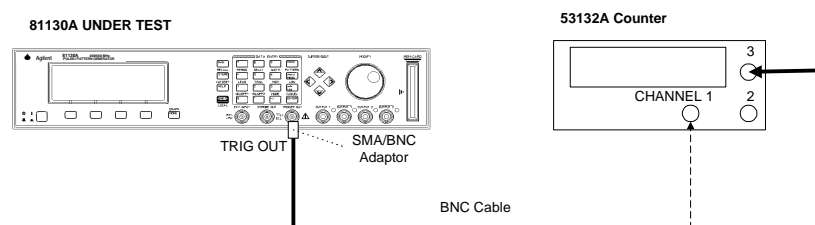

Connecting Agilent 81130A to the Counter

4. Set up the Agilent 81130A as described in "Initial Setup of the Agilent 81130A"
5. Press MORE and select the [MODE/TRG] screen on the Agilent 81130A and set up as follows:

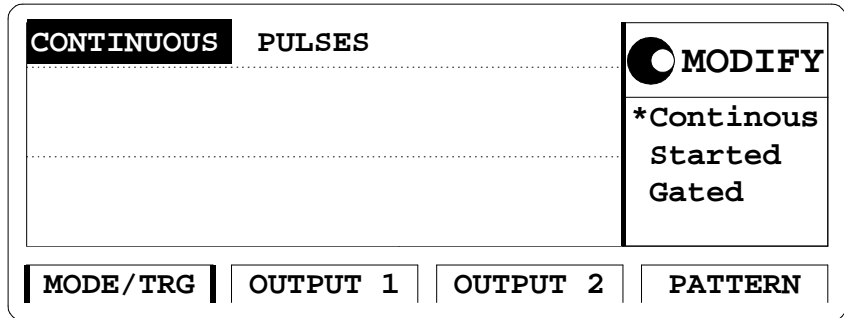

The MODE/TRG Screen Setup

- On the Agilent 81130A set up [OUTPUT 1] and [OUTPUT 2] pages as follows:

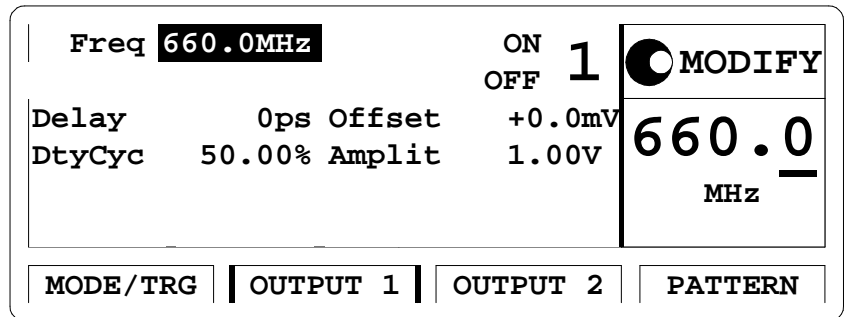

Configuring Output 1

Freq <b>660.0MHz</b>		ON	2	MODIFY
		OFF		
Delay	0ps	Offset	+0.0mV	660.0 MHz
DtyCyc	50.00%	Amplit	1.00V	
Separate Out2				
MODE/TRG	OUTPUT 1	OUTPUT 2	PATTERN	

### Configuring Output 2

**NOTE:**

When you are testing instruments with 2 output channels it is necessary to:

- a. Configure *both* channels.
- b. You can switch OFF the channels that are not being tested.

7. Set the Counter to measure the frequency at the chosen input  
1 / 3

8. Check the Agilent 81130A frequency at the following settings:

Period	Frequency	Acceptable Range	TR Entry
1.515 ns	660.000MHz	659.9340 MHz to 660.0660 MHz	1 - 1
10.00 ns	100 MHz	99.990 MHz to 100.010 MHz	1 - 2
50.00 ns	20 MHz	19.9980 MHz to 20.0020 MHz	1 - 3
100 ns	10 MHz	9.9990 MHz to 10.0010 MHz	1 - 4
500 ns	2 MHz	1.9998 MHz to 2.0002 MHz	1 - 5
1 $\mu$ s	1 MHz	999.9 kHz to 1.0001 MHz	1 - 6
5.882 $\mu$ s	170.0 kHz	169.983 kHz to 170.017 kHz	1 - 7

---

## Test 2: Width

### Test Specifications

Range	750 ps to (period - 750 ps)
Resolution	4 digits, best case 2 ps
Accuracy	$\pm 0.01\% \pm 200$ ps

### Equipment Needed

Digitizing Oscilloscope with Accessories  
Counter  
Cable, 50  $\Omega$ , coaxial, BNC; SMA/BNC Adaptor

### Procedure

1. Connect Agilent 81130A to the Scope as shown:

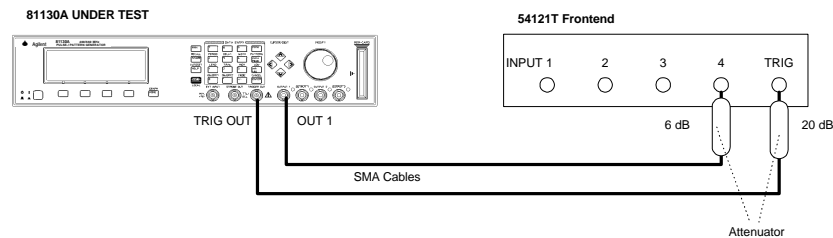

### Connecting Agilent 81130A to the Scope

2. Set up the Agilent 81130A as described in "Initial Setup of the Agilent 81130A"

- On the Agilent 81130A set up [OUTPUT 1] and [OUTPUT 2] pages as shown in the following illustrations:

Per	200 ns	ON	1	<input checked="" type="radio"/> MODIFY				
		OFF						
Delay	0ps	Offset	+0.0mV	100.0 ns				
Width	100.0ns	Amplit	1.00V					
<table border="1"> <tr> <td>MODE/TRG</td> <td>OUTPUT 1</td> <td>OUTPUT 2</td> <td>PATTERN</td> </tr> </table>					MODE/TRG	OUTPUT 1	OUTPUT 2	PATTERN
MODE/TRG	OUTPUT 1	OUTPUT 2	PATTERN					

Configuring Output Screen 1

Per	200 ns	OFF	2	<input checked="" type="radio"/> MODIFY				
		OFF						
Delay	0ps	Offset	+0.0mV	750 ps				
Width	750ps	Amplit	1.00V					
<p style="text-align: center;">Separate Out2</p> <table border="1"> <tr> <td>MODE/TRG</td> <td>OUTPUT 1</td> <td>OUTPUT 2</td> <td>PATTERN</td> </tr> </table>					MODE/TRG	OUTPUT 1	OUTPUT 2	PATTERN
MODE/TRG	OUTPUT 1	OUTPUT 2	PATTERN					

Configuring Output Screen 2

---

**NOTE:**

When you are testing instruments with 2 output channels it is necessary to:

- a. Configure *both* channels.
- b. Switch OFF the channel that is not being tested

If you then test the other channel:

- c. Switch ON the channel you are testing, and switch OFF the other channel.
- 

4. Set the Digitizing Oscilloscope Agilent 54121T:
  - Press AUTOSCALE
  - Select the Display menu and set the Number of Averages to 32
  - Select the delta V menu and turn the voltage markers On
  - Set the preset levels to 50% -50% and press AUTO LEVEL SET
  - Select the delta t menu and turn the time markers ON
  - Set START ON EDGE = POS 1 and STOP ON EDGE = NEG1
5. Change the oscilloscope timebase to 1 ns/div
6. Change the Agilent 81130A Ch-1 Width to 750ps
7. Center the pulse in the Scope display
8. Press the PRECISE EDGE FIND key for each new Width setting
9. Check the Agilent 81130A pulse width at the following settings:

Agilent 81130A/'32A Performance Test

Oscilloscope Timebase	Period	Width	Acceptable Range	TR Entry
1 ns/div	200 ns	750 ps	549.925ps to 950.075ps	2 - 1
2 ns/div	200 ns	10.00 ns	9.799 ns to 10.201 ns	2 - 2
10 ns/div	200 ns	50.00 ns	49.795 ns to 50.205 ns	2 - 3
20 ns/	1 $\mu$ s	100.0 ns	99.790 ns to 100.210 ns	2 - 4
100 ns	1 $\mu$ s	500.0 ns	499.750 ns to 500.250 ns	2 - 5

10. Connect the Agilent 81130A to the Counter as shown:

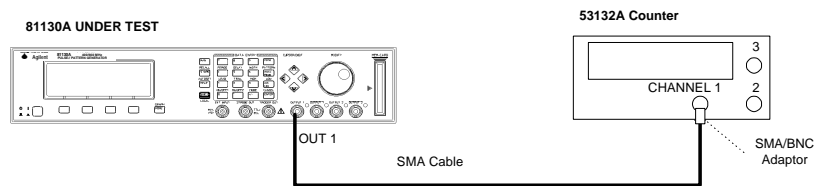

Connecting Agilent 81130A to the Counter

11. Set the Counter to:

FUNCTION      PULSE WIDTH A  
 INPUT A      50  $\Omega$

12. Check the Agilent 81130A width at the following settings:

Period	Width	Acceptable Range	TR Entry
5.882 $\mu$ s	1 $\mu$ s	0.9997 $\mu$ s to 1.0003 $\mu$ s	2 - 6
5.882 $\mu$ s	5 $\mu$ s	4.9993 $\mu$ s to 5.0007 $\mu$ s	2 - 7

**NOTE:**

Repeat the entire test for the second channel, if it is installed

---

## Test 3: Delay

### Test Specifications

Range	Variable Delay: 0 ns to 3.00 $\mu$ s
	Fixed typical Delay of
	CLK/REF IN to TRIGGER OUT 21ns
	CLK/REF IN to OUTPUT 1/2 53ns
	EXT INPUT to TRIGGER OUT 22 ns
	EXT INPUT to OUTPUT 1/2 54 ns
Resolution	4 digits, best case 2 ps
Accuracy	$\pm 0.01\%$ $\pm 100$ ps relative to the zero-delay

### Equipment Needed

Digitizing Oscilloscope with Accessories  
 Power Splitter  
 Counter  
 Cable, 50  $\Omega$ , coaxial, BNC; SMA/BNC Adaptor

### Procedure

Connect Agilent 81130A to the Scope as shown:

## Agilent 81130A/'32A Performance Test

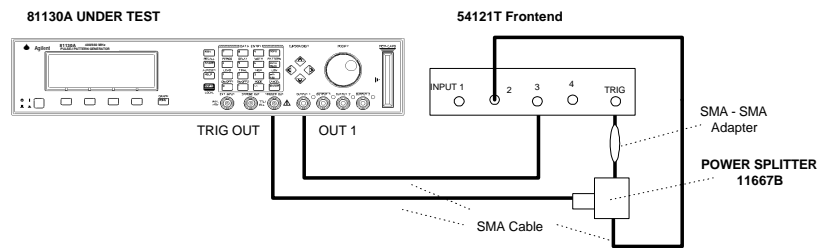

### Connecting Agilent 81130A to the Scope

1. Set up the Agilent 81130A as described in "Initial Setup of the Agilent 81130A"
2. On the Agilent 81130A set up [OUTPUT 1] and [OUTPUT 2] pages as shown in the following illustrations:

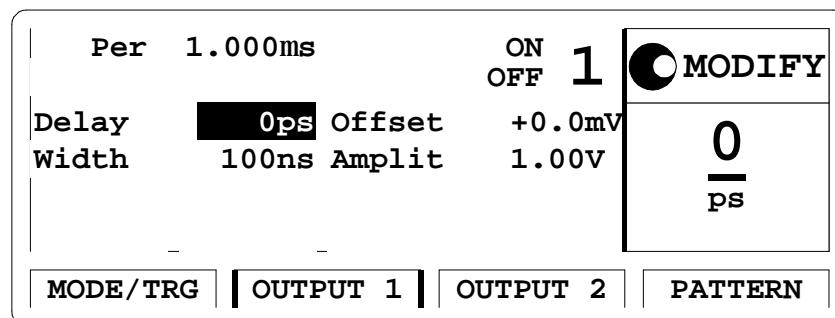

### Configuring Output Screen 1

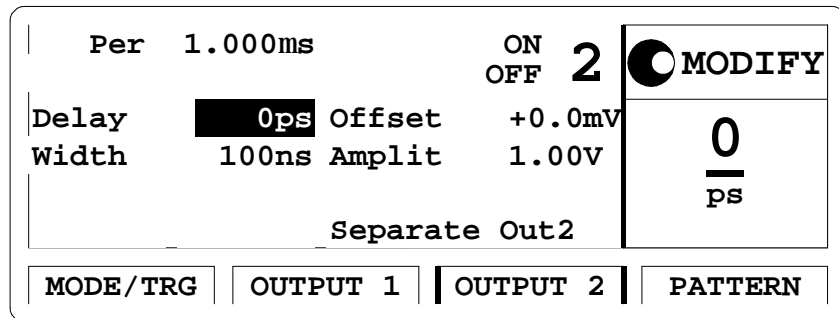

### Configuring Output Screen 2

**NOTE:**

When you are testing instruments with 2 output channels it is necessary to:

- a. Configure *both* channels.
- b. Switch OFF the channel that is not being tested

If you then test the other channel:

- c. Switch ON the channel you are testing, and switch OFF the other channel.

### 3. Set the Digitizing Oscilloscope Agilent 54121T:

- Press AUTOSCALE
- Set timebase to TIME/DIV = 1 ns/div
- Select the Display menu and set the screen function to single; set the number of averages to 16

Agilent 81130A/32A Performance Test

- Set the first positive-going edges of the output signal to the fourth vertical line from left
- Select the Delta V menu and turn the voltage markers ON and assign markers to channel 3
- Set Preset levels to 50% - 50% and press AUTO LEVEL SET
- Select the Delta t menu and turn the time markers ON
- Set START ON EDGE= POS1 and STOP ON EDGE= POS 1
- Press the PRECISE EDGE FIND key

4. Check the Agilent 81130A delay at the following settings:

Oscilloscope Timebase	Delay	Acceptable Range	TR Entry
1 ns/div	5.000 ns	4.35 ns to 5.1005 ns	3 - 1
2 ns/div	10.00 ns	9.899 ns to 10.101 ns	3 - 2
10 ns/div	50.00 ns	49.895 ns to 50.105 ns	3 - 3
20 ns/div	100.0 ns	99.890 ns to 100.110 ns	3 - 4
100 ns/div *	500.0 ns	499.850 ns to 500.150 ns	3 - 5

\* Oscilloscope Delay to min. = 16.0000 ns

**NOTE:**

With each new Oscilloscope Timebase setting set the Agilent 81130A Delay to Ops, press START ON EDGE= POS1 and PRECISE EDGE FIND do the next Agilent 81130A Delay setting and

ONLY press STOP ON EDGE= POS 1

5. Connect the Agilent 81130A to the Counter as follows:

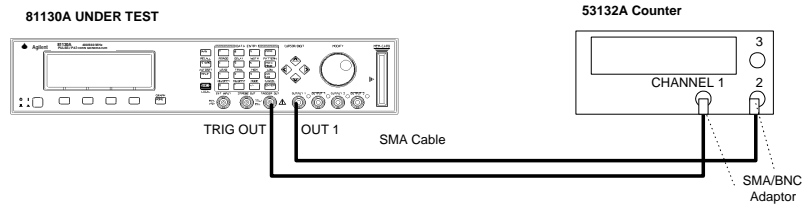

Connecting Agilent 81130A to the Counter

6. Set the Counter to:

FUNCTION TI A → B  
 INPUT A 50 Ω  
 INPUT B 50 Ω

7. Check the Agilent 81130A delay at the following setting:

**NOTE:**

Subtract the fixed delay from the other readings

Period	Delay	Acceptable Range	TR Entry
5.882 μs	3.00 μs	2.9996 μs to 3.0004 μs	3 - 7

**NOTE:**

Repeat the entire test for the second channel, if it is installed.

## **Test 4: Jitter**

The following tests are required:

1. Period Jitter
2. Width Jitter
3. Delay Jitter

### **Test 4.1: Period Jitter**

#### **Test Specifications**

RMS-Jitter 0.001% + 15 ps

#### **Equipment Needed**

Digitizing Oscilloscope with Accessories  
Delay Line (22 ns)  
Power Splitter

#### **Procedure**

1. Connect Agilent 81130A to the Scope as shown.

Agilent 81130A/'32A Performance Test

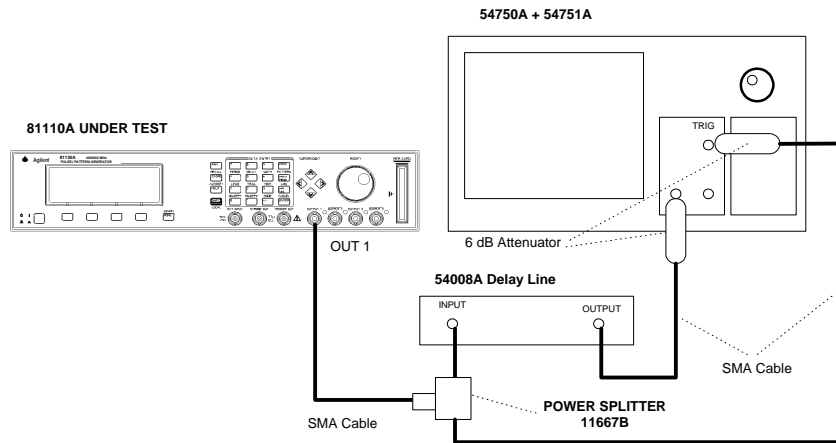

Equipment Set-up for Jitter Test using the Agilent 54750A + 54751A

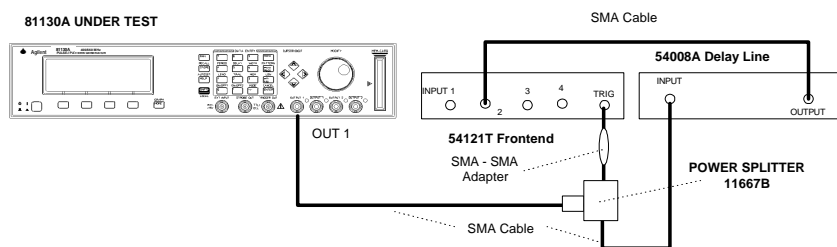

Equipment Set-up using the Agilent 54121T .

2. Set up the Agilent 81130A as described in "Initial Setup of the Agilent 81130A"
3. On the Agilent 81130A set up [OUTPUT 1] and [OUTPUT 2] pages as shown in the following illustrations:

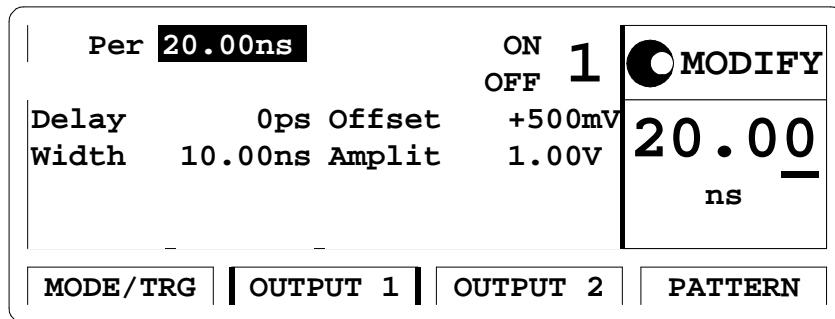

Configuring Output Screen 1

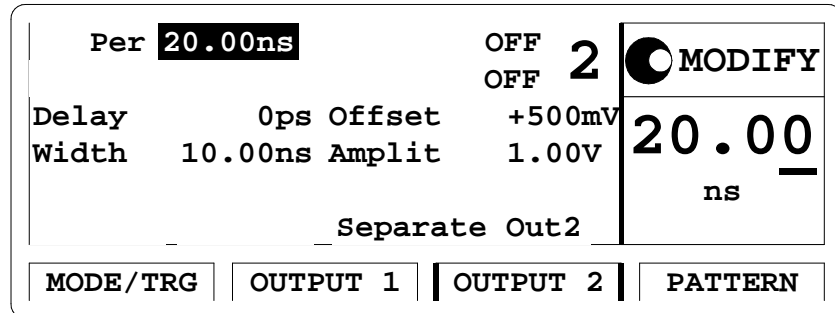

Configuring Output Screen 2

---

**NOTE:**

When you are testing instruments with 2 output channels it is necessary to:

- a. Configure *both* channels.
- b. Switch OFF the channel that is not being tested

If you then test the other channel:

- c. Switch ON the channel you are testing, and switch OFF the other channel.
- 

4. Set the Digitizing Oscilloscope Agilent 54121T:

- Press AUTOSCALE
- Select the Display menu and set the Number of Averages to 64
- Select the Channel menu and set the Attenuation factor of channel 2 to 2
- Set the VOLTS/DIV of channel 2 to 10 mV/div
- Set OFFSET to 500 mV
- Select the Timebase menu and set the TIME/DIV to 100 ps/div
- Center the first positive-going edge of the signal
- Select the Delta V menu and turn the V markers On
- Set the Marker 1 Position to 490 mV and the Marker 2 Position to 500mV
- Select the Delta t menu and turn the T Markers On
- Set START ON EDGE = POS1 and STOP ON EDGE = POS1
- Press the PRECISE EDGE FIND key

5. RECORD the delta t reading. This is the rise time of the reference signal within a 1% amplitude window of the signal connected to Input 2. This value is needed later to calculate the correct jitter. (delta.t.up)
6. Select the Timebase menu and center the second positive-going edge of the signal
7. Press MORE and HISTOGRAM
  - Select the Window submenu and set:
    - Source is channel 2
    - Choose the Time Histogram
    - Press WINDOW MARKER 1 and set it to 490 mV
    - Press WINDOW MARKER 2 and set it to 500 mV
8. Select the Acquire submenu, set the Number of Samples to 1000 and press START ACQUIRING
9. After the data for the time histogram has been acquired (# Samples = 100%), select the Result submenu.
10. Press MEAN and SIGMA. RECORD the values of sigma
11. The RMS-jitter is calculated as follows:

$$RMS - jitter = \frac{6sigma - delta.t.up}{6}$$

12. The RMS-jitter for period of 20 ns is 15.2 ps. Enter the result in the Test Report as TR entry 4.1 - 1

---

***NOTE:***

---

See the Agilent54750A User's Guide / Service Guide to get the info needed to do the Jitter Test using this scope.

## Test 4.2: Width Jitter

### Test Specifications

RMS-Jitter 0.001% + 15 ps

### Equipment Needed

Digitizing Oscilloscope with Accessories  
Delay Line (22 ns)  
Power Splitter

### Procedure

1. Connect Agilent 81130A to the Scope as shown:

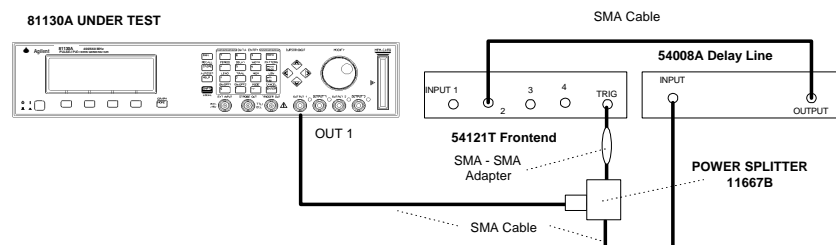

### Equipment Set-up for Jitter Test

2. Set up the Agilent 81130A as described in "Initial Setup of the Agilent 81130A"

- On the Agilent 81130A set up [OUTPUT 1] and [OUTPUT 2] pages as shown in the following illustrations:

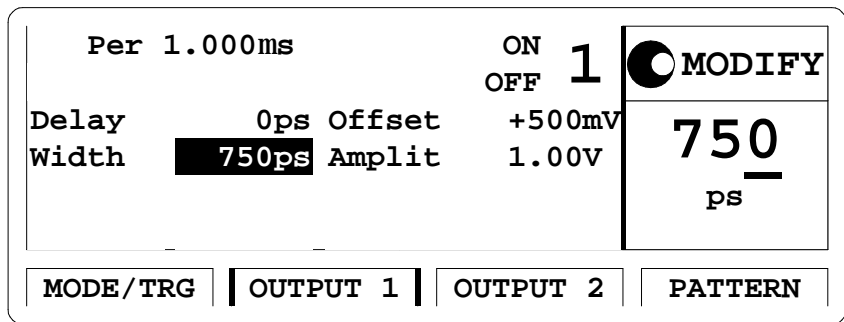

Configuring Output Screen 1

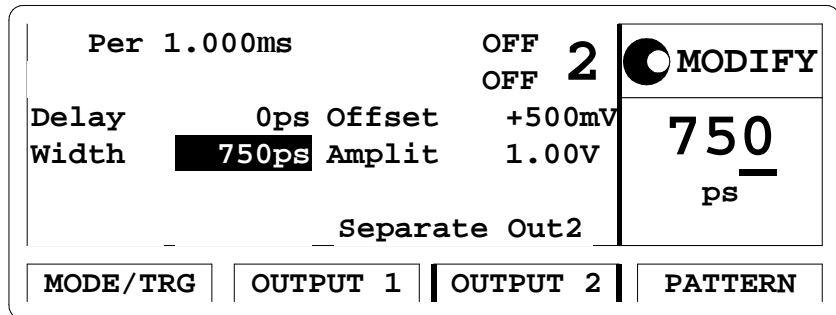

Configuring Output Screen 2

---

**NOTE:**

When you are testing instruments with 2 output channels it is necessary to:

- a. Configure *both* channels.
- b. Switch OFF the channel that is not being tested

If you then test the other channel:

- c. Switch ON the channel you are testing, and switch OFF the other channel.
- 

4. Set the Digitizing Oscilloscope Agilent 54121T:

- Press AUTOSCALE
- Select the Display menu and set the Number of Averages to 128
- Select the Channel menu and set the Attenuation factor of channel 2 to 2
- Set the VOLTS/DIV of channel 2 to 10 mV/div
- Set OFFSET to 500 mV
- Select the Timebase menu and set the TIME/DIV to 10 ps/div
- Center the first negative-going edge of the signal
- Select the Delta V menu and turn the V markers On
- Set the Marker 1 Position to 500 mV and the Marker 2 Position to 490 mV
- Select the Delta t menu and turn the T Markers On
- Set START ON EDGE = NEG1 and STOP ON EDGE = NEG1
- Press the PRECISE EDGE FIND key

5. RECORD the delta t reading. This is the fall time of the reference signal within a 1% amplitude window of the signal connected to Input 2. This value is needed later to calculate the correct jitter. (delta.t.dn)
6. Set the Agilent 81130A Pulse Width to 50 ns
7. Select the Timebase menu and center the first negative-going edge of the signal (Delay approx. 80 ns)
8. Press MORE and HISTOGRAM
9. Select the Window submenu and set:
  - Source is channel 2
  - Choose the Time Histogram
  - Press WINDOW MARKER 1 and set it to 500 mV
  - Press WINDOW MARKER 2 and set it to 490 mV
10. Select the Acquire submenu, set the Number of Samples to 1000 and press START ACQUIRING
11. After the data for the time histogram has been acquired (# Samples = 100%), select the Result submenu.
12. Press MEAN and SIGMA. RECORD the value of sigma
13. The RMS-jitter is calculated as follows:

$$\text{RMS - jitter} = \frac{6 \text{ sigma} - \text{delta.t.dn}}{6}$$

14. The RMS-jitter for pulse width of 50 ns is 15.5 ps. Enter the result in the Test Report as TR entry 4.2 - 1
15. Set the Agilent 81130A for pulse width of 500ns
16. Repeat steps 7 to 13

---

***NOTE:***

TIME/DIV = 100ps/div. Approximate delay = 530 ns

17. The RMS-jitter for pulse width of 500 ns is 20 ps. Enter the result in the Test Report as TR entry 4.2 - 2

---

***NOTE:***

Repeat the entire test for the second channel, if it is installed.

### Test 4.3: Delay Jitter

#### Test Specifications

RMS-Jitter 0.001% + 15 ps

#### Equipment Needed

Digitizing Oscilloscope with Accessories

#### Procedure

1. Connect Agilent 81130A to the Scope as shown:

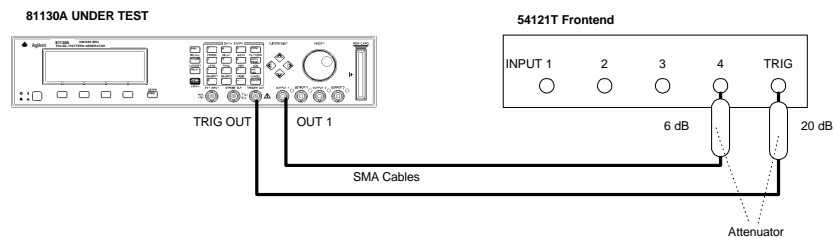

#### Equipment Set-up for Delay Jitter Test

2. For calculating the RMS-jitter, the rise time of the reference signal within a 1% amplitude window is required. If this value

is not already measured in the Period Jitter test, then perform the first 6 steps of the Period Jitter test.

3. Set up the Agilent 81130A as described in "Initial Setup of the Agilent 81130A"
4. On the Agilent 81130A set up [OUTPUT 1] and [OUTPUT 2] pages as shown in the following illustrations:

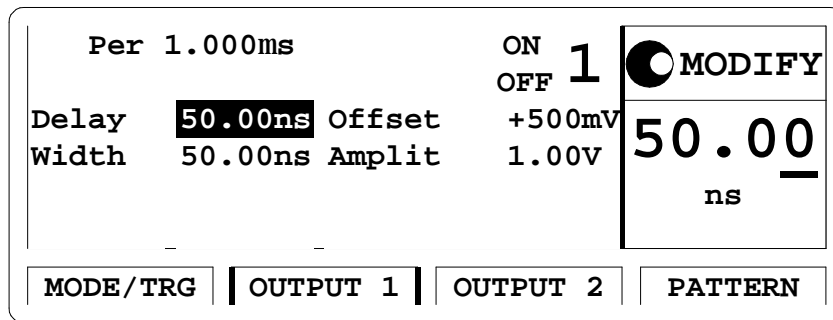

Configuring Output Screen 1

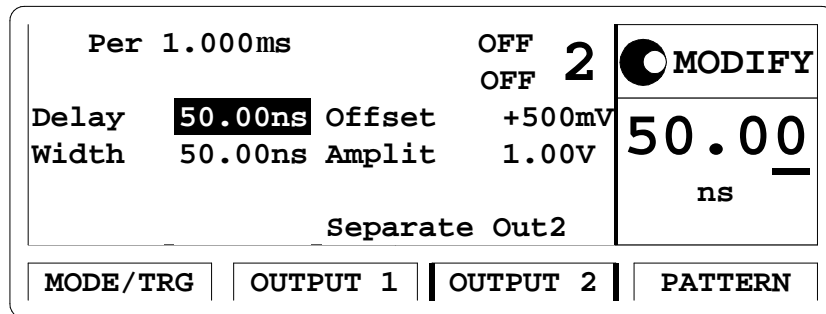

Configuring Output Screen 2

---

**NOTE:**

When you are testing instruments with 2 output channels it is necessary to:

- a. Configure *both* channels.
- b. Switch OFF the channel that is not being tested

If you then test the other channel:

- c. Switch ON the channel you are testing, and switch OFF the other channel.

- 
5. Set the Digitizing Oscilloscope Agilent 54121T:
    - Press AUTOSCALE
    - Select the Display menu and set the Number of Averages to 64
    - Set the VOLTS/DIV = 10 mV/div
    - Set OFFSET to 500 mV
    - Select the Timebase menu and set the TIME/DIV to 100 ps/div
    - Center the first positive-going edge of the signal (Delay approx. 80 ns)
  6. Press MORE and HISTOGRAM
  7. Select the Window submenu and press WINDOW MARKER 1 and set it to 490 mV
  8. Press WINDOW MARKER 2 and set it to 500 mV
  9. Select the Acquire submenu, set the Number of Samples to 1000 and press START ACQUIRING

10. After the delta for the time histogram has been acquired (# Samples = 100%), select the Result submenu.
11. Press MEAN and SIGMA. RECORD the values of sigma!
12. The RMS-jitter is calculated as follows:

$$\text{RMS - jitter} = \frac{6\sigma - \Delta t_{up}}{6}$$

13. The RMS-jitter for pulse width of 50 ns is 15.5 ps. Enter the result in the Test Report as TR entry 4.3 - 1
14. Set Agilent 81130A for delay of 500 ns
15. Repeat steps 9 to 12

---

**NOTE:**

TIME/DIV = 100 ps/div. Approximate delay = 530 ns

16. The RMS-jitter for pulse width of 500 ns is 20 ps. Enter the result in the Test Report as TR entry 4.3 - 2

---

**NOTE:**

Repeat the entire test for the second channel, if it is installed.

---

## Test 5: High and Low Levels

The following tests are required:

1. High level from 50Ω into 50Ω
2. Low level from 50Ω into 50Ω

### Test Specifications

	Load Impedance 50 Ω	
Source Impedance	50 Ω	
High Level	-1.900 V to +2.5 V	
Low Level	-2.0 V to +2.4 V	
Amplitude	0.100 V <sub>pp</sub> to 2.5 V <sub>pp</sub>	
Level Resolution	10 mV	
Level Accuracy	± 5% of ampl ± 50 mV	

### Equipment Needed

1. Digitizing Voltmeter (DVM)
2. 50 Ω Feedthrough Termination, 0.1%, 10 W Adaptor.
3. BNC to dual banana plug (1251-2277)
4. SMA Cable, SMA/BNC Adaptor

### Procedure

Connect Agilent 81130A to the DVM as shown:

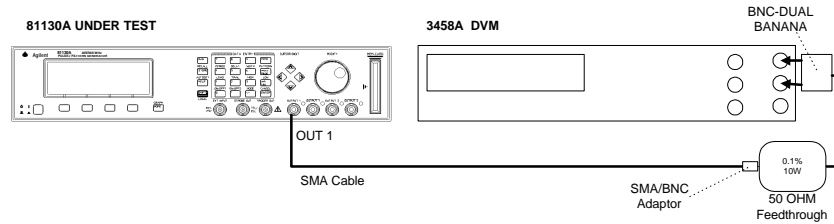

Connecting the DVM for High and Low Levels Tests

**Test 5.1: High Level, 50 Ohms into 50 Ohms**

1. Set up the Agilent 81130A as described in "Initial Setup of the Agilent 81130A"
2. On the Agilent 81130A set up [MODE/TRIG] page as shown in the following illustration:

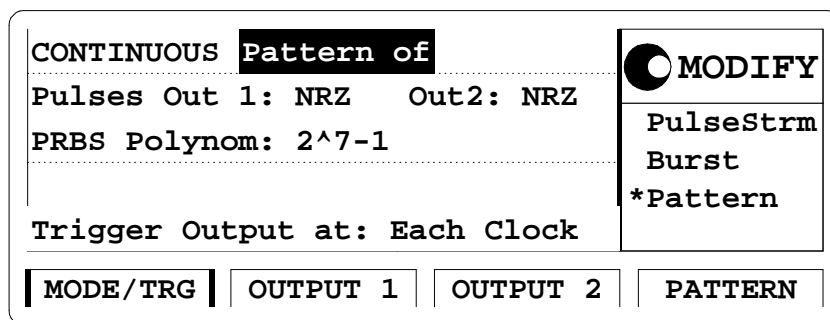

Configuring MODE/TRIG Screen

- On the Agilent 81130A set up [Pattern] pages

Segment	Length	Loopcnt	Update	<input type="radio"/> MODIFY
1	65504	1		65504
2				
3				
4				

MODE/TRG | OUTPUT 1 | OUTPUT 2 | PATTERN

Configuring Pattern Screen

With the cursor key *left* highlight the “1” of Segment and press ENTER

Segment	1	Update	<input type="radio"/> MODIFY
Address		Length 65504	Data Seg
CH1 High	1	1 1 1 1 1 1	*High Seg
CH2 Low	0	0 0 0 0 0 0	Low Seg
Both	1	1 1 1 1 1 1	PRBS Seg

MODE/TRG | OUTPUT 1 | OUTPUT 2 | PATTERN

Configuring Pattern Screen

- On the Agilent 81130A set up [OUTPUT 1] and [OUTPUT 2] pages as shown in the following illustrations:

Freq 170.0kHz		ON OFF 1	<input checked="" type="radio"/> MODIFY
Delay	0.00ps High	+2.50V	+2.50 V
Width	----- Low	+0.0mV	
_			
MODE/TRG	OUTPUT 1	OUTPUT 2	PATTERN

Configuring Output Screen 1

Freq 170.0kHz		ON OFF 2	<input checked="" type="radio"/> MODIFY
Delay	0.00ps High	+2.50V	+2.50 V
Width	----- Low	+0.0mV	
_		Separate Out2	
MODE/TRG	OUTPUT 1	OUTPUT 2	PATTERN

Configuring Output Screen 2

**NOTE:**

When you are testing instruments with 2 output channels it is necessary to:

- a. Configure *both* channels.

b. Switch OFF the channel that is not being tested

If you then test the other channel:

c. Switch ON the channel you are testing, and switch OFF the other channel.

5. Set the DVM Agilent 3458A to:

Function: DCV  
 Trigger: TRIG INT

6. Check the Agilent 81130A high level at the following high level settings with the low level set to 0.0 V.

High Level	Acceptable Range	TR Entry
2.50 V	2.325 V to 2.675 V	5.1 - 1
1.0 V	0.90 V to 1.10 V	5.1 - 2
0.5 V	425 mV to 575 mV	5.1 - 3
0.1 V	45 mV to 155 mV	5.1 - 4

The low level may vary within  $\pm 5\%$  of amplitude  $\pm 50$  mV  
 To check the low level change on the [Pattern] page  
 CH1 to \* Low Seg.

**Test 5.2: Low Level, 50 Ohms into 50 Ohms**

1. Set up the Agilent 81130A as described in "Initial Setup of the Agilent 81130A"
2. On the Agilent 81130A set up [Pattern] page

Segment	1	Update	<input type="radio"/> MODIFY
Address		Length	65504
CH1	High	0	0 0 0 0 0 0
CH2	Low	0	0 0 0 0 0 0
Both		0	0 0 0 0 0 0
			Data Seg
			High Seg
			*Low Seg
			PRBS Seg
MODE/TRG		OUTPUT 1	OUTPUT 2
		PATTERN	

Configuring Pattern Screen

- On the Agilent 81130A set up [OUTPUT 1] and [OUTPUT 2] pages as shown in the following illustrations:

Freq	170.0kHz	ON	1	<input type="radio"/> MODIFY
		OFF		
Delay	0.00ps High		+0.0mV	-100 mV
Width	----- Low		-100mV	
MODE/TRG		OUTPUT 1	OUTPUT 2	PATTERN

Configuring Output Screen 1

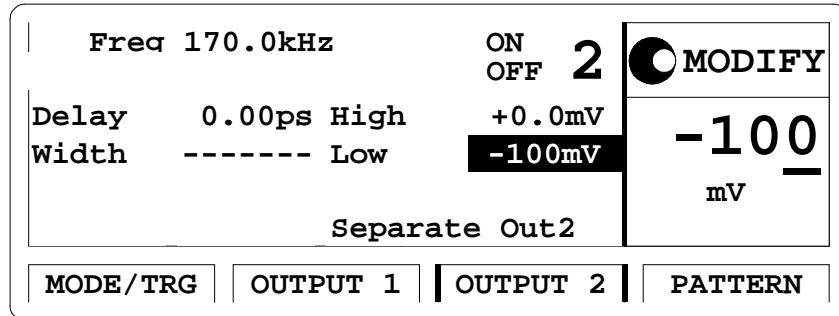

Configuring Output Screen 2

**NOTE:**

When you are testing instruments with 2 output channels it is necessary to:

- a. Configure *both* channels.
- b. Switch OFF the channel that is not being tested

If you then test the other channel:

- c. Switch ON the channel you are testing, and switch OFF the other channel.

4. Check the Agilent 81130A low level at the following low level settings with the high level set to 0.0 V

Low Level	Acceptable Range	TR Entry
-0.1 V	-45 mV to -155 mV	5.2 - 1
-0.5 V	-425 mV to -575 mV	5.2 - 2
-1.0 V	-0.90 V to -1.10 V	5.2 - 3
-2.00 V	-1.850 V to -2.150 V	5.2 - 4

The high level 0.0 V may vary  $\pm 5\%$  of amplitude  $\pm 50$  mV.  
To check the low level change on the the [Pattern] page  
CH1 to \* High Seg.

---

**NOTE:**

---

Repeat the High and Low Level tests for the second channel, if it  
is installed.



Agilent 81130A/32A Performance Test

Test Equipment Used				
Description	Model No.	Trace No.	Cal.	Due
Date				
1. Oscilloscope	Agilent 54121T	_____	_____	_____
2. Counter	Agilent 53132A	_____	_____	_____
3. Digital Voltmeter	Agilent 3458A	_____	_____	_____
4. Delay Line	Agilent 54008A	_____	_____	_____
5. _____	_____	_____	_____	_____
6. _____	_____	_____	_____	_____
7. _____	_____	_____	_____	_____
8. _____	_____	_____	_____	_____
9. _____	_____	_____	_____	_____
10. _____	_____	_____	_____	_____
11. _____	_____	_____	_____	_____
12. _____	_____	_____	_____	_____
13. _____	_____	_____	_____	_____
14. _____	_____	_____	_____	_____

**Test Results for Agilent 81130A Mainframe**

Serial No. \_\_\_\_\_ Ambient temperature \_\_\_\_\_  
 °C

Customer \_\_\_\_\_ Relative humidity \_\_\_\_\_ %

CSO# \_\_\_\_\_ Line frequency \_\_\_\_\_ Hz

Tested by \_\_\_\_\_ Date \_\_\_\_\_

Comments

\_\_\_\_\_  
 \_\_\_\_\_  
 \_\_\_\_\_

**Frequency**

Counter Uncertainty factor \_\_\_\_\_

TR Entry	Test	Limit Min	Actual Result	Limit Max	Pass	Fail
1-1	660MHz	659.9340MHz	_____	660.0660MHz	__	__
1-2	100MHz	99.990MHz	_____	100.010 MHz	__	__
1-3	20MHz	19.9980MHz	_____	20.0020MHz	__	__
1-4	10MHz	9.9990MHz	_____	10.0010MHz	__	__

Agilent 81130A/32A Performance Test

1-5	2MHz	1.9998MHz	_____	2.0002MHz	__	__
1-6	1 MHz	999.9 kHz	_____	1.0001 MHz	__	__
1-7	170kHz	169.983 kHz	_____	170.017 kHz	__	__

**Period Jitter**

Scope Uncertainty factor \_\_\_\_\_

TR Entry	Test	Limit Min	Actual Result	Limit Max	Pass	Fail
4.1 -1	20 ns		_____	15.2 ps	__	__

**Test Results for Agilent 81132A Output Channel \_\_\_\_\_**  
 Serial No. \_\_\_\_\_

**Width**

Scope Uncertainty factor \_\_\_\_\_

TR Entry	Test	Limit Min	Actual Result	Limit Max	Pass	Fail
2-1	750ps	549.925ps	_____	950.075ps	_____	_____
2-2	10.0 ns	9.799ns	_____	10.201 ns	_____	_____
2-3	50.0 ns	49.795 ns	_____	50.205 ns	_____	_____
2-4	100 ns	99.790 ns	_____	100.210 ns	_____	_____
2-5	500 ns	499.750 ns	_____	500.250 ns	_____	_____
2-6	1 $\mu$ s	0.9997 $\mu$ s	_____	1.0003 $\mu$ s	_____	_____
2-7	5 $\mu$ s	4.9993 $\mu$ s	_____	5.0007 ms	_____	_____

**Width Jitter**

Scope Uncertainty factor \_\_\_\_\_

TR Entry	Test	Limit Min	Actual Result	Limit Max	Pass	Fail
4.2-1	50 ns		_____	15.5 ps	_____	_____
4.2-2	500 ns		_____	20 ps	_____	_____

**Delay**

Scope Uncertainty factor \_\_\_\_\_

TR Entry	Test	Limit Min	Actual Result	Limit Max	Pass	Fail
3-1	5.00 ns	4.8995 ns	_____	5.1005 ns	_____	_____
3-2	10.00 ns	9.899 ns	_____	10.101 ns	_____	_____
3-3	50.00 ns	49.895 ns	_____	50.105 ns	_____	_____
3-4	100.0 ns	99.890 ns	_____	100.110 ns	_____	_____
3-5	500.0 ns	499.850 ns	_____	500.150 ns	_____	_____
3-6	3 $\mu$ s	2.9996 $\mu$ s	_____	3.0004 $\mu$ s	_____	_____

**Delay Jitter**

Scope Uncertainty factor \_\_\_\_\_

TR Entry	Test	Limit Min	Actual Result	Limit Max	Pass	Fail
4.3-1	50 ns		_____	15.5 ps	_____	_____
4.3-2	500 ns		_____	20 ps	_____	_____

**High Level 50Ω-50Ω**

TR Entry	Test	Limit Min	Actual Result	Limit Max	Pass	Fail
5.1-1	2.50V	2.325 V	_____	2.675 V	_____	_____
5.1-2	1.0 V	0.90 V	_____	1.10 V	_____	_____
5.1-3	0.5 V	425 mV	_____	575 mV	_____	_____
5.1-4	0.1 V	45 mV	_____	155 mV	_____	_____

**Low Level 50Ω-50Ω**

TR Entry	Test	Limit Min	Actual Result	Limit Max	Pass	Fail
5.2-1	-0.1 V	-45 mV	_____	-155 mV	_____	_____
5.2-2	-0.5 V	-425 mV	_____	-575 mV	_____	_____
5.2-3	-1.0 V	-0.90 V	_____	-1.10 V	_____	_____
5.2-4	-2.00V	-1.850 V	_____	-2.150 V	_____	_____

Agilent 81130A/32A Performance Test

Publication Number: 5988-4856EN

